



Cladify™



MITREX™

CLADIFY / MITREX

41 RACINE ROAD

CLIENT: CLADIFY / MITREX

ARCHITECT:

CladiCast

CLADIFY / MITREX LIGHT WEIGHT PRECAST SOLUTION

Date: SEPTEMBER 05, 2023

CONFIDENTIAL: ALL DRAWINGS ARE COPYRIGHT PROPERTY AND OWNED BY CLADIFY. ANY USE OR REPRODUCTION OF THESE DRAWINGS OR THE INFORMATION CONTAINED THEREIN WITHOUT THE EXPRESS WRITTEN PERMISSION OF CLADIFY, IS STRICTLY PROHIBITED.

- GENERAL NOTES:
1. ALL DIMENSIONS, LEVELS, AND DETAILS WILL BE BASED ON ARCHITECTURAL DRAWINGS ISSUED BY DESIGNER.
 2. ALL PANEL SIZES ARE BASED ON THE ARCHITECTURAL DRAWINGS, APPROVED SHOP DRAWINGS, AND SLAB EDGE MEASUREMENTS ISSUED.
 3. ALL CLADIFY PANELS ARE PORCELAIN FACING WITH ALUMINUM HONEY COMB BACKING.
- NOTE:
4. DUE TO THE SIZE OF THE PANELS, THE PRODUCTION MANAGER MAY SUGGEST THICKER ALUMINUM BACKING SYSTEM.
 5. DUE TO THE SIZE OF THE PANELS, THE REQUIRED TEMPERATURE FOR INSTALLATION IS +12 °C.
 6. ALL HORIZONTAL AND VERTICAL JOINTS ARE 20mm UNLESS NOTED OTHERWISE. MAKE UP ALONG ENTIRE LENGTH TO ACCOUNT FOR DIMENSIONAL ROUNDING OF INDIVIDUAL STONE LENGTHS.
 7. SITE CUT STONE TO SUIT CONDITIONS ARE REQUIRED.
 8. DO NOT SCALE DRAWING.
 9. PANEL SIZE TOLERANCE IS -1-2 INCHES.
 10. DUE TO WALL ASSEMBLY DEPTH, CLADDING SYSTEM MAY VARY.
 11. SYSTEM SIZE TO BE CONFIRMED.
 12. PENETRATIONS TO BE SEALED.

ABBREVIATIONS:

CL = CLADIFY	E/O = END OF
T/O = TOP OF	C/O = CORNER OF
B/O = BOTTOM OF	TYP. = TYPICAL
REF. = REFERENCE/REFER	SIM. = SIMILAR
M/E = MITERED EDGE	F/O = FACE OF

SEAL

0	2023-08-22	INITIAL SHOP DRAWINGS
---	------------	-----------------------

REV. YY-MM-DD DESCRIPTION

ARCHITECT

CLIENT

PROJECT TITLE
CladiCast
LIGHT WEIGHT PRECAST SOLUTION

SHEET TITLE
CONNECTOR DETAILS

INFORMATION
DATE: 2023-08-22
SCALE: AS INDICATED
DRAWN BY: GC
MEASURED BY:
CHECKED BY: AR / AS

DRAWING NO:
PC-E

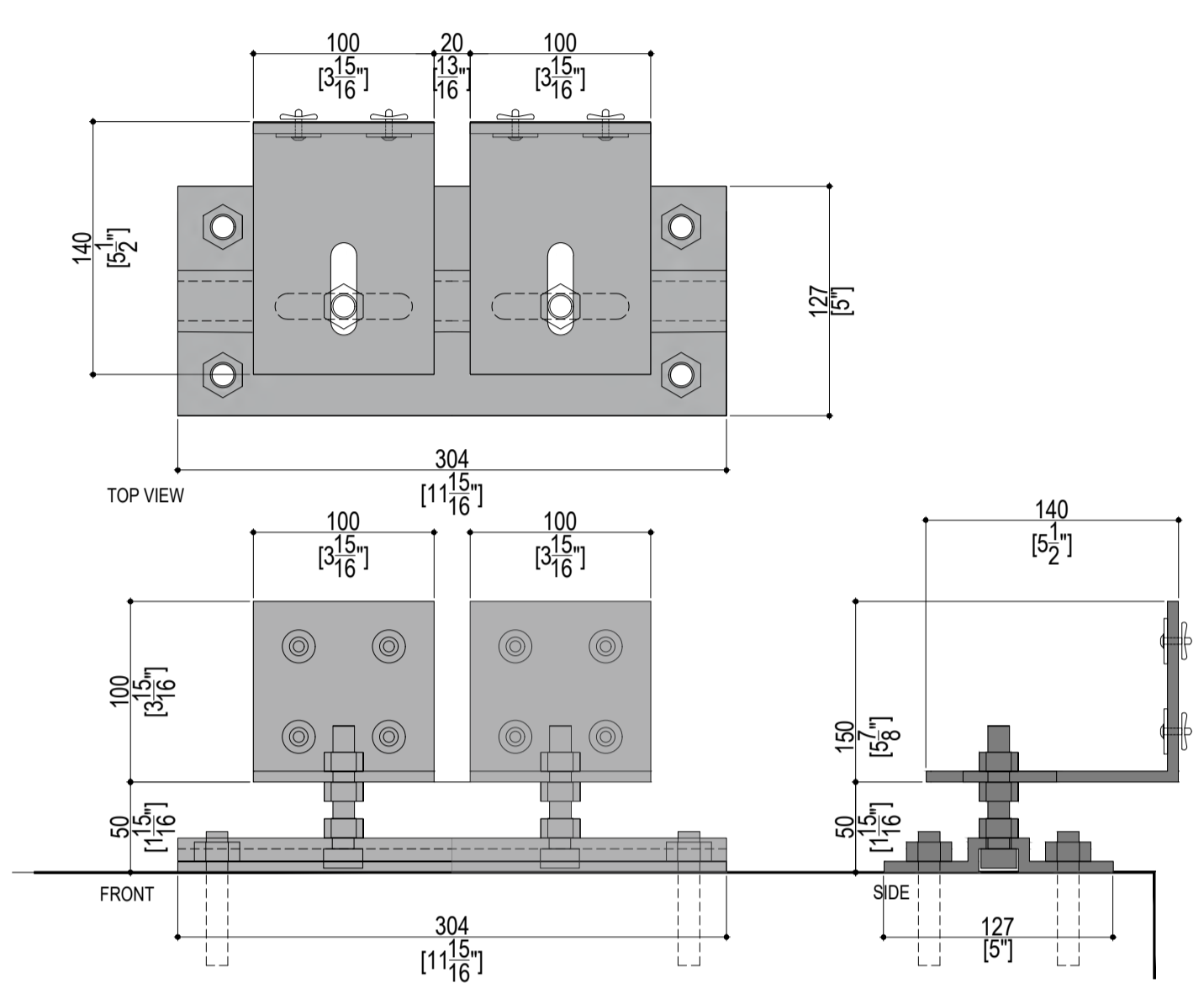

CONNECTOR TYPE - 01A (T1A) (DOUBLE)

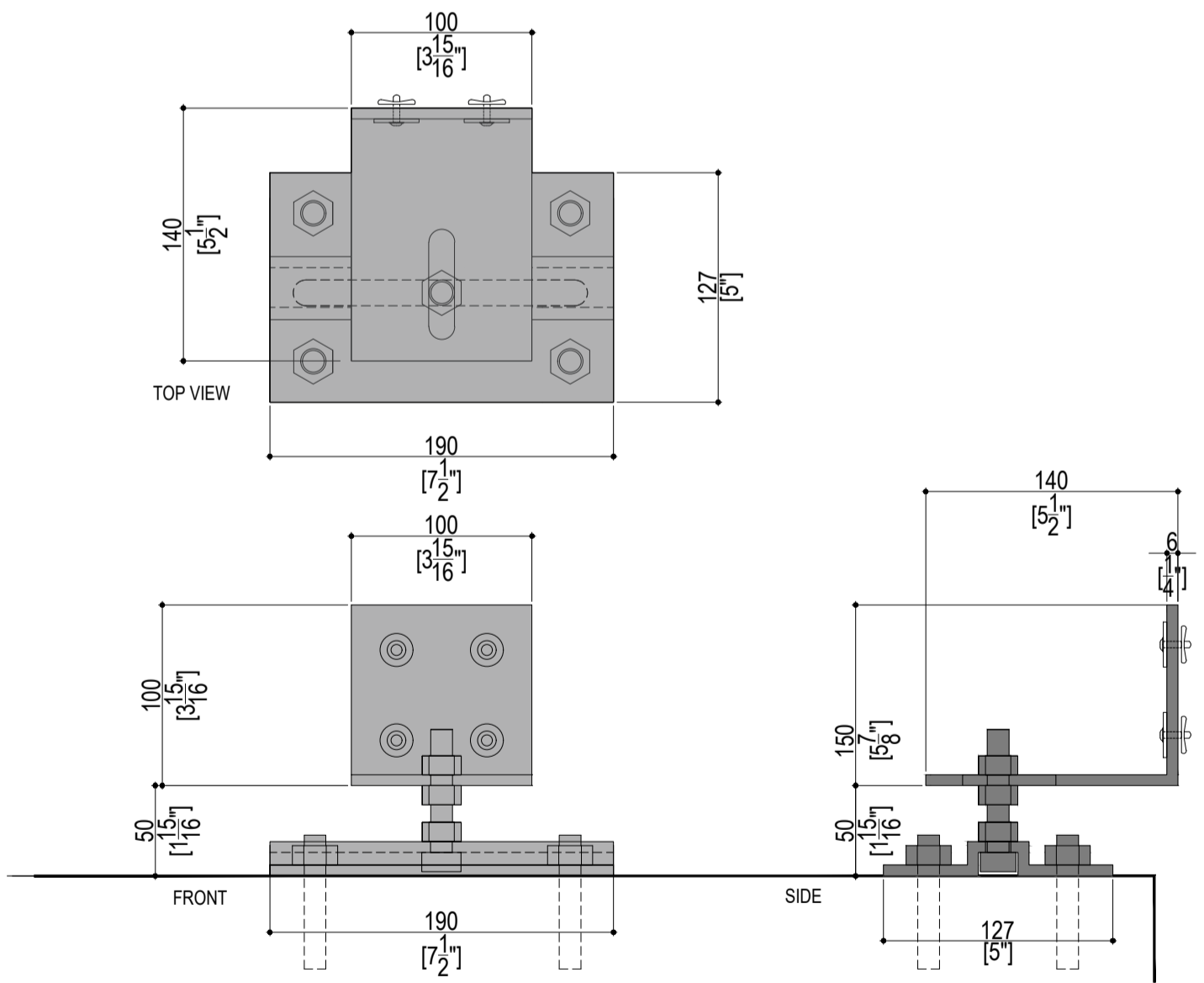

CONNECTOR TYPE - 01 (T1) (SINGLE)

TYPE 01 - TOP MOUNT BASE CONNECTORS

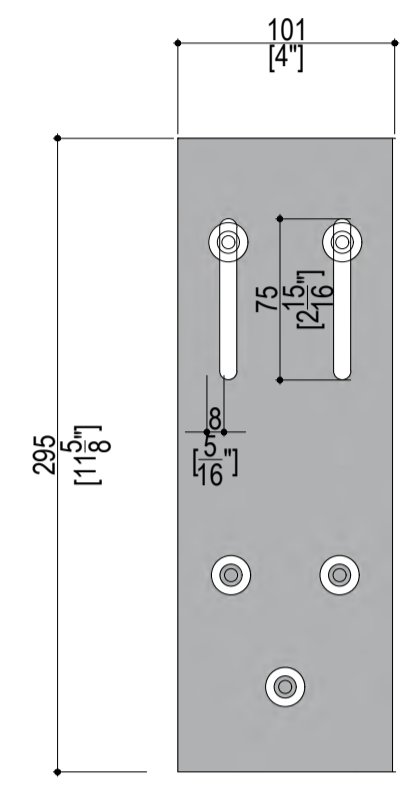
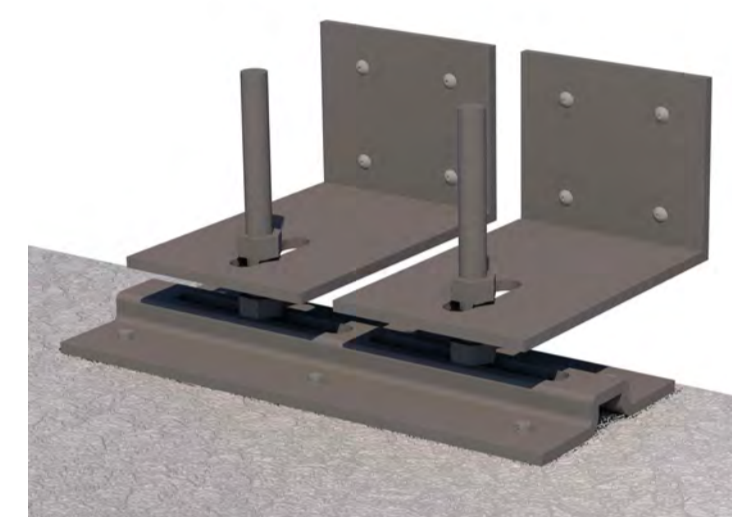

CONNECTOR TYPE - 02

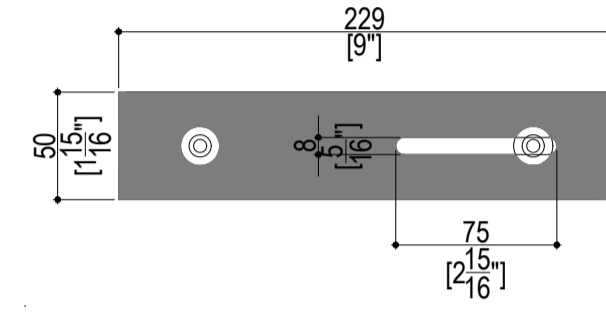

CONNECTOR TYPE - 03

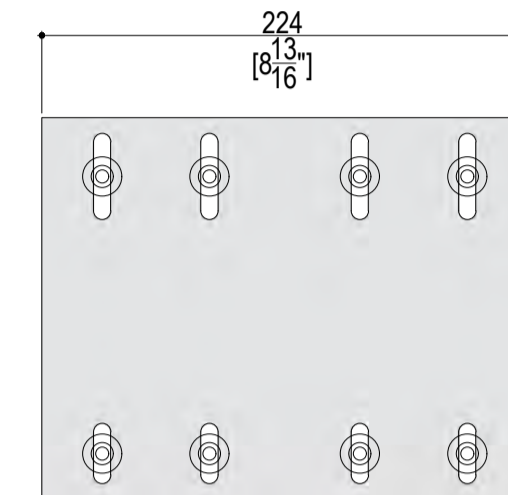

CONNECTOR TYPE - AP

PANEL CONNECTORS (2 mm THICKNESS)

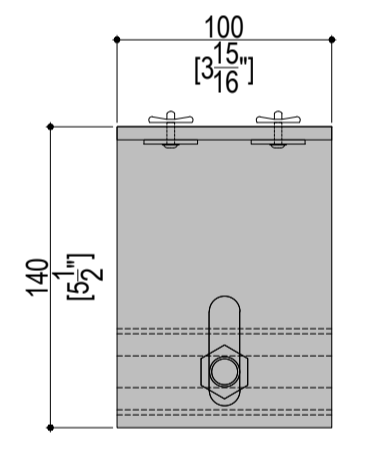

T1B-SINGLE - PLAN

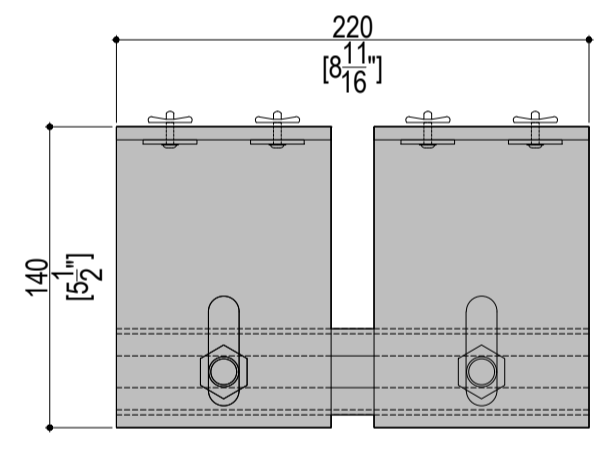

T1B-DOUBLE - PLAN

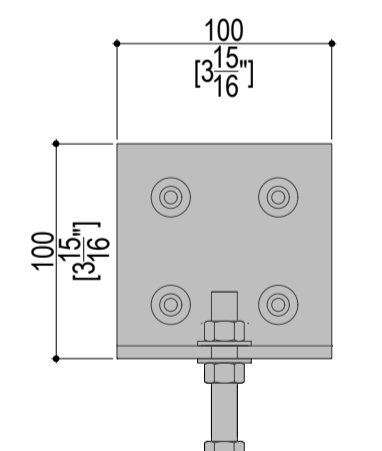

T1B-SINGLE - FRONT

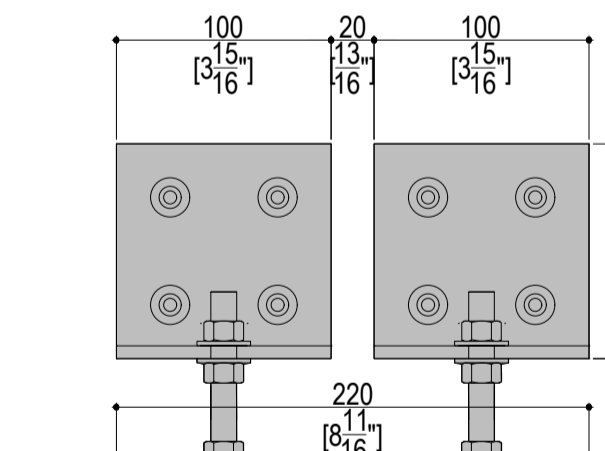

T1B-DOUBLE - FRONT

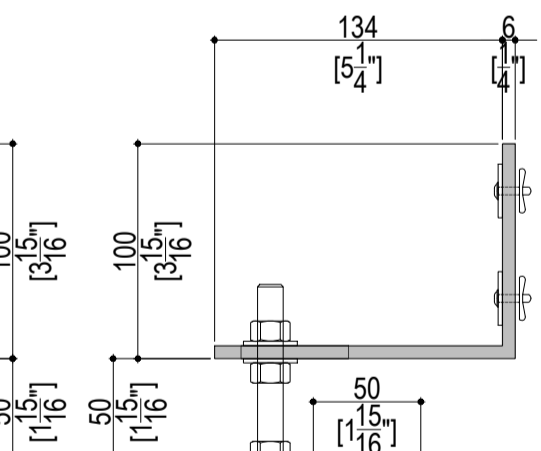

T1B-TYPICAL SECTION

CONNECTOR TYPE - 01 (T1B)



TYPE 01 - CAST-IN PLACE (EMBEDDED) BASE CONNECTOR

CONFIDENTIAL: ALL DRAWINGS ARE COPYRIGHT PROPERTY AND OWNED BY CLADIFY. ANY USE OR REPRODUCTION OF THESE DRAWINGS OR THE INFORMATION CONTAINED THEREIN WITHOUT THE EXPRESS WRITTEN PERMISSION OF CLADIFY, IS STRICTLY PROHIBITED.

GENERAL NOTES:

- ALL DIMENSIONS, LEVELS, AND DETAILS WILL BE BASED ON ARCHITECTURAL DRAWINGS ISSUED BY DESIGNER.
 - ALL PANEL SIZES ARE BASED ON THE ARCHITECTURAL DRAWINGS, APPROVED SHOP DRAWINGS, AND SLAB EDGE MEASUREMENTS ISSUED.
 - ALL CLADIFY PANELS ARE PORCELAIN FACING WITH ALUMINUM HONEY COMB BACKING.
- NOTE:
- DUE TO THE SIZE OF THE PANELS, THE PRODUCTION MANAGER MAY SUGGEST THICKER ALUMINUM BACKING SYSTEM.
 - DUE TO THE SIZE OF THE PANELS, THE REQUIRED TEMPERATURE FOR INSTALLATION IS +12 °C.
 - ALL HORIZONTAL AND VERTICAL JOINTS ARE 20mm UNLESS NOTED OTHERWISE. MAKE UP ALONG ENTIRE LENGTH TO ACCOUNT FOR DIMENSIONAL ROUNDING OF INDIVIDUAL STONE LENGTHS.
 - SITE CUT STONE TO SUIT CONDITIONS ARE REQUIRED.
 - DO NOT SCALE DRAWING.
 - PANEL SIZE TOLERANCE IS -1-2 INCHES.
 - DUE TO WALL ASSEMBLY DEPTH, CLADDING SYSTEM MAY VARY.
 - SYSTEM SIZE TO BE CONFIRMED.
 - PENETRATIONS TO BE SEALED.

ABBREVIATIONS:

CL = CLADIFY
T/O = TOP OF
B/O = BOTTOM OF
REF. = REFERENCE/REFER
M/E = MITERED EDGE

E/O = END OF
C/O = CORNER OF
TYP = TYPICAL
SIM = SIMILAR
F/O = FACE OF

SEAL

REV.	YY-MM-DD	DESCRIPTION
0	2023-08-22	INITIAL SHOP DRAWINGS

ARCHITECT

CLIENT

PROJECT TITLE

CladiCast
LIGHT WEIGHT PRECAST SOLUTION

SHEET TITLE

PANEL PLAN LAYOUT SCENARIOS

INFORMATION

DATE: 2023-08-22
SCALE: AS INDICATED
DRAWN BY: GC
MEASURED BY:
CHECKED BY: AR / AS

DRAWING NO:

PC-001

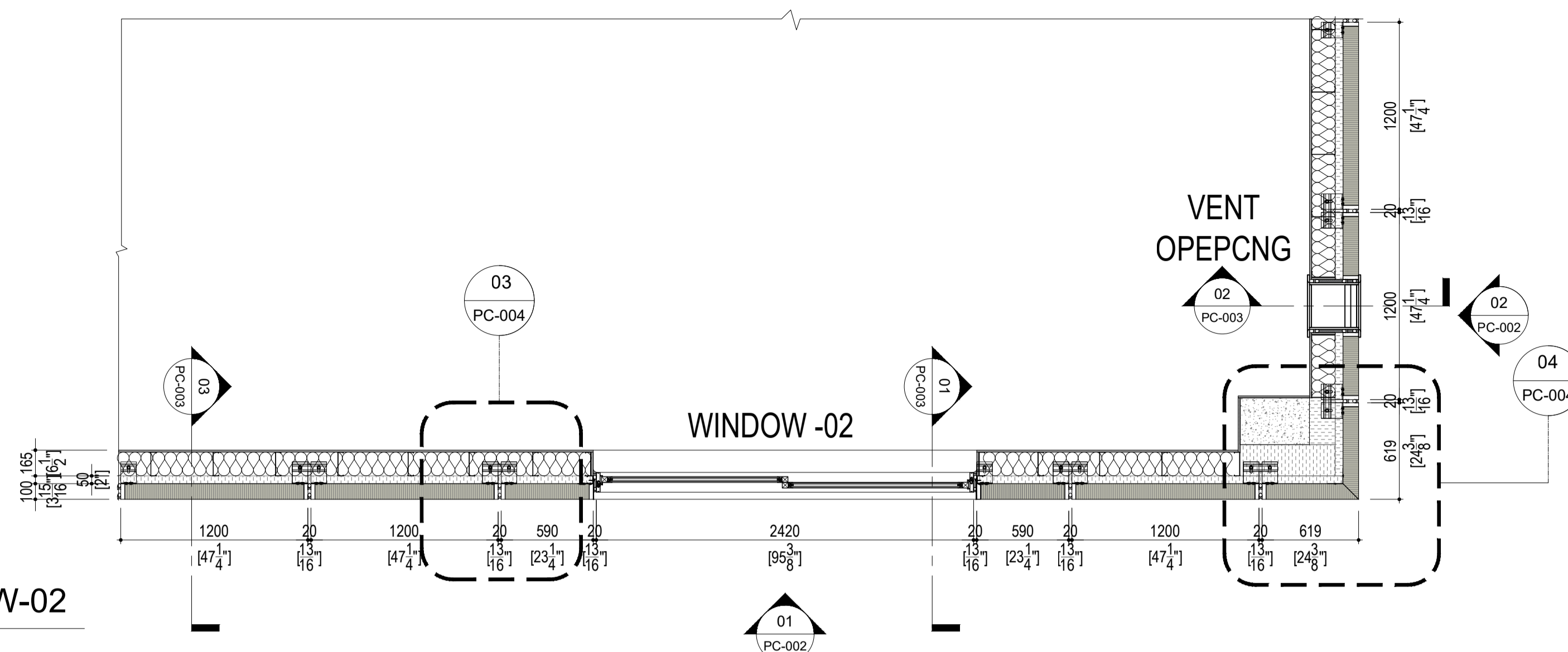

03
PC-001
PANEL LAYOUT @ WINDOW-02
SCALE: 1:40

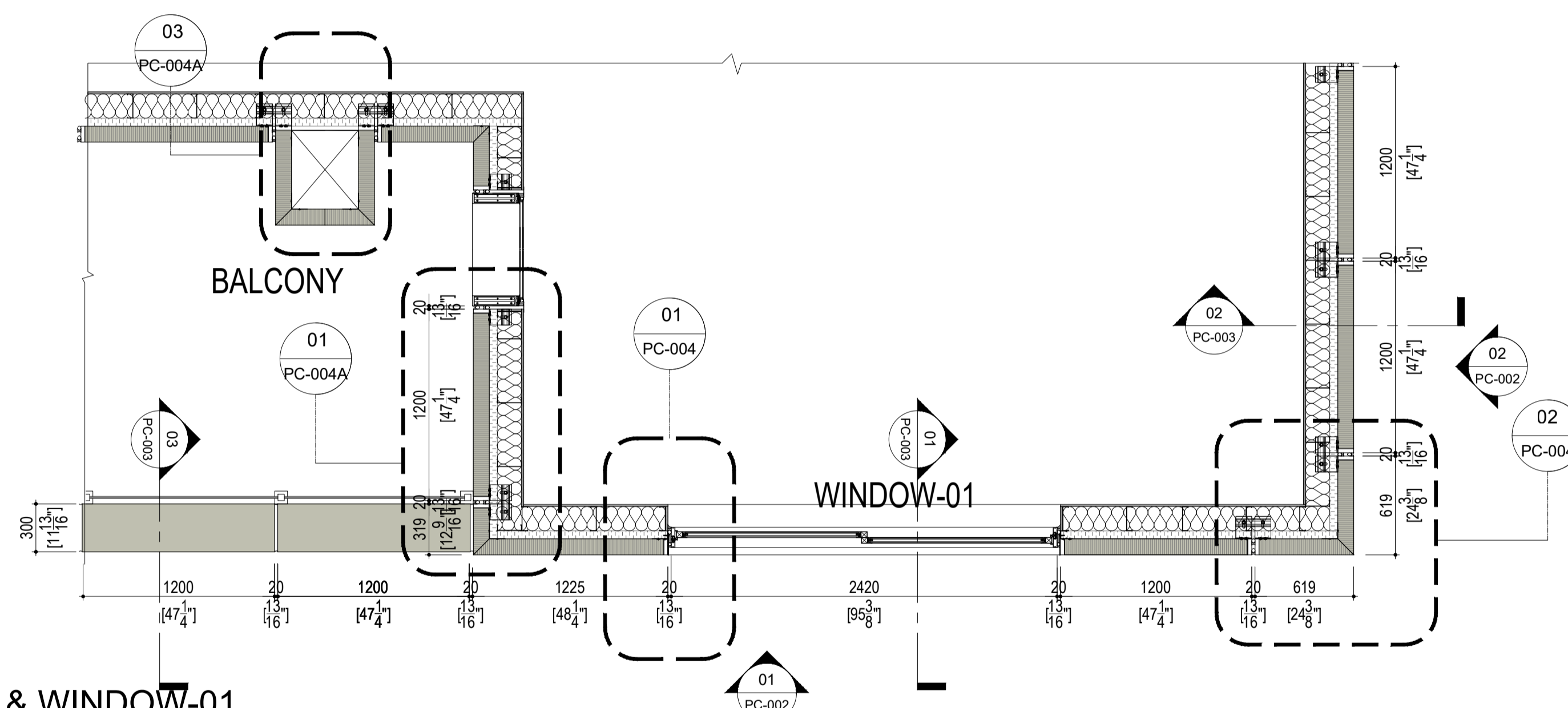

02
PC-001
PANEL LAYOUT @ BALCONY & WINDOW-01
SCALE: 1:40

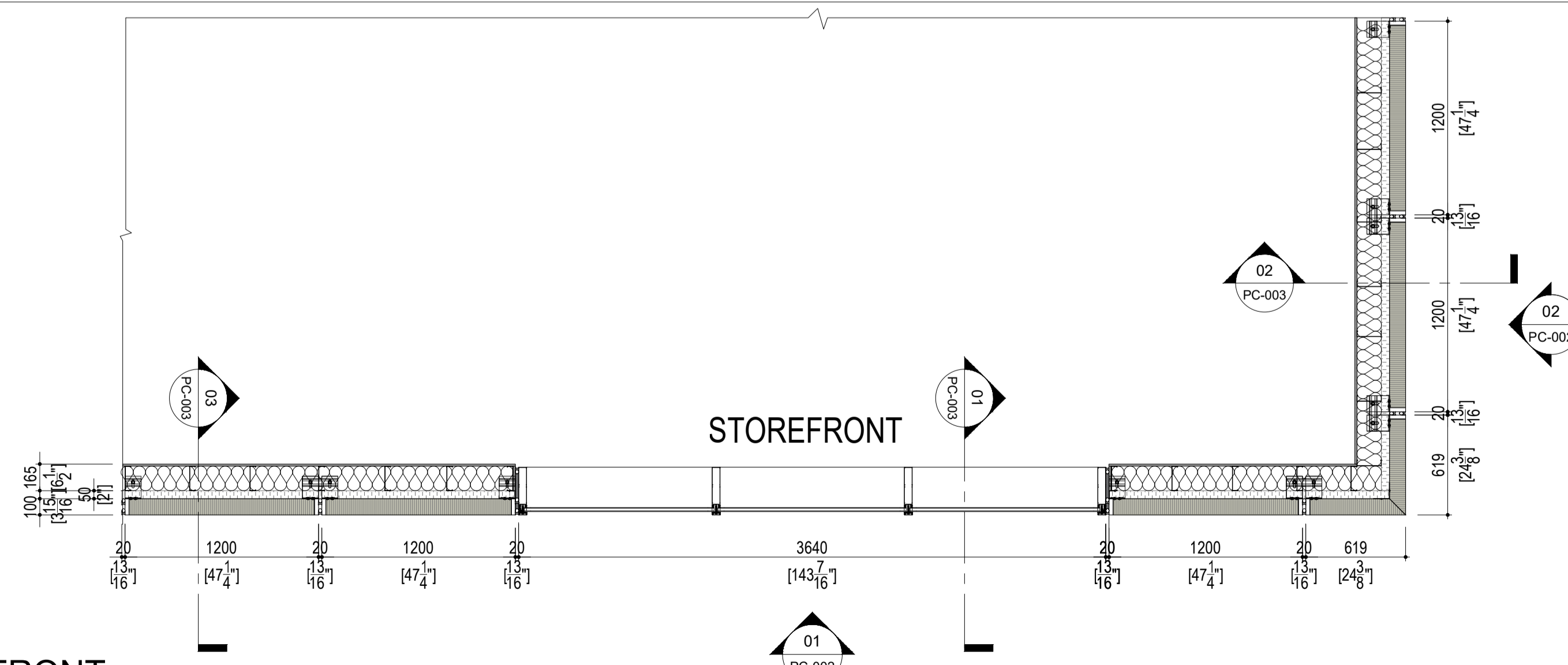

01
PC-001
PANEL LAYOUT @ STOREFRONT
SCALE: 1:40

CONFIDENTIAL: ALL DRAWINGS ARE COPYRIGHT PROPERTY AND OWNED BY CLADIFY. ANY USE OR REPRODUCTION OF THESE DRAWINGS OR THE INFORMATION CONTAINED THEREIN WITHOUT THE EXPRESS WRITTEN PERMISSION OF CLADIFY, IS STRICTLY PROHIBITED.

- GENERAL NOTES:
- ALL DIMENSIONS, LEVELS, AND DETAILS WILL BE BASED ON ARCHITECTURAL DRAWINGS ISSUED BY DESIGNER.
 - ALL PANEL SIZES ARE BASED ON THE ARCHITECTURAL DRAWINGS, APPROVED SHOP DRAWINGS, AND SLAB EDGE MEASUREMENTS ISSUED.
 - ALL CLADIFY PANELS ARE PORCELAIN FACING WITH ALUMINUM HONEY COMB BACKING.

- NOTE:
- DUE TO THE SIZE OF THE PANELS, THE PRODUCTION MANAGER MAY SUGGEST THICKER ALUMINUM BACKING SYSTEM.
 - DUE TO THE SIZE OF THE PANELS, THE REQUIRED TEMPERATURE FOR INSTALLATION IS +12 °C.
 - ALL HORIZONTAL AND VERTICAL JOINTS ARE 20mm UNLESS NOTED OTHERWISE. MAKE UP ALONG ENTIRE LENGTH TO ACCOUNT FOR DIMENSIONAL ROUNDING OF INDIVIDUAL STONE LENGTHS.
 - SITE CUT STONE TO SUIT CONDITIONS ARE REQUIRED.
 - DO NOT SCALE DRAWING.
 - PANEL SIZE TOLERANCE IS -1-2 INCHES
 - DUE TO WALL ASSEMBLY DEPTH, CLADDING SYSTEM MAY VARY.
 - SYSTEM SIZE TO BE CONFIRMED.
 - PENETRATIONS TO BE SEALED

ABBREVIATIONS:

CL = CLADIFY
T/O = TOP OF
B/O = BOTTOM OF
REF. = REFERENCE/REFER
M/E = MITERED EDGE

E/O = END OF
C/O = CORNER OF
TYP. = TYPICAL
SIM. = SIMILAR
F/O = FACE OF

SEAL

0	2023-08-22	INITIAL SHOP DRAWINGS
---	------------	-----------------------

REV. YY-MM-DD DESCRIPTION

ARCHITECT

CLIENT

PROJECT TITLE

CladiCast
LIGHT WEIGHT PRECAST SOLUTION

SHEET TITLE

PLAN DETAILS

INFORMATION

DATE: 2023-08-22
SCALE: AS INDICATED
DRAWN BY: GC
MEASURED BY:
CHECKED BY: AR / AS

DRAWING NO:

PC-004

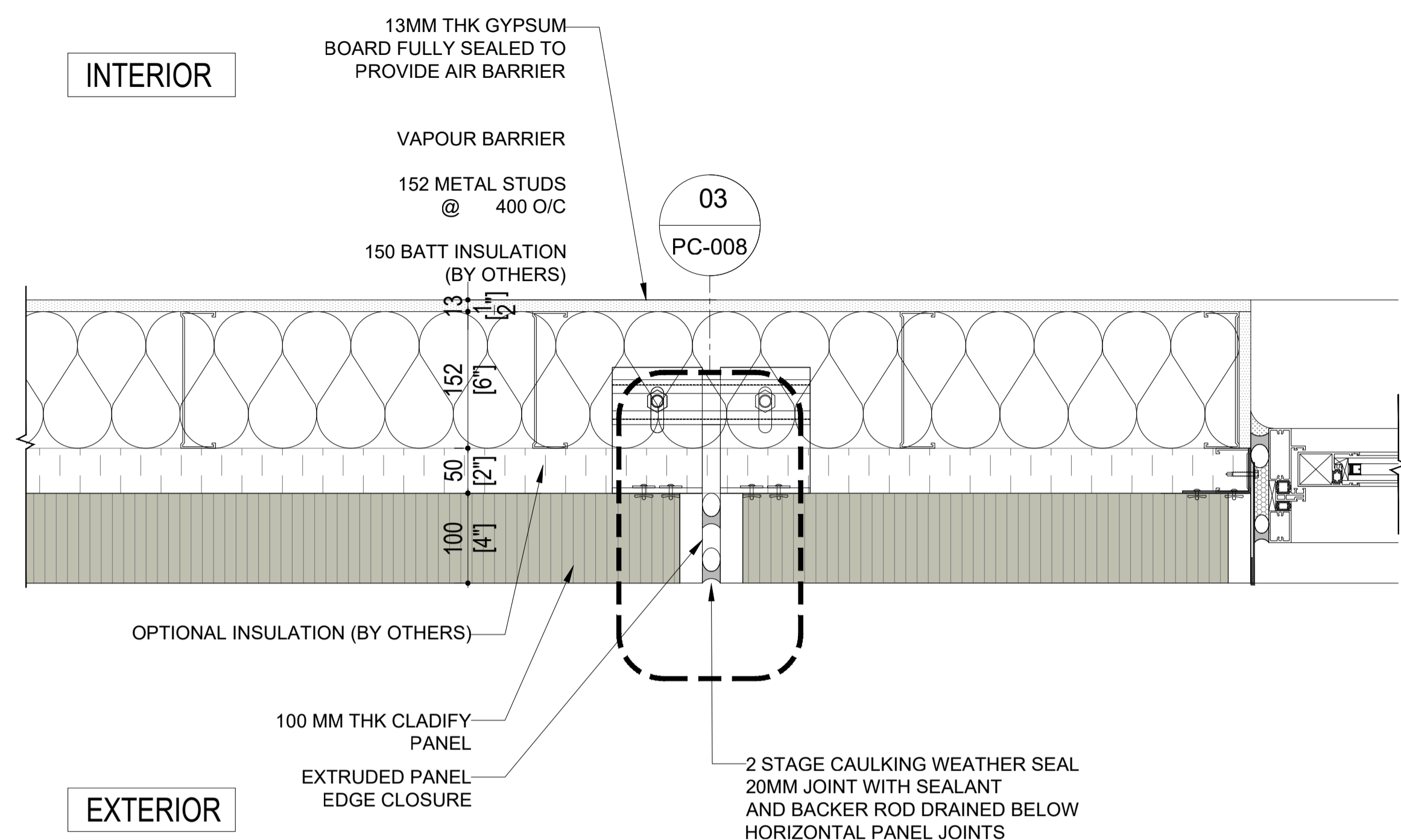

03 PANEL TO PANEL DETAIL
PC-004 SCALE: 1:7.5

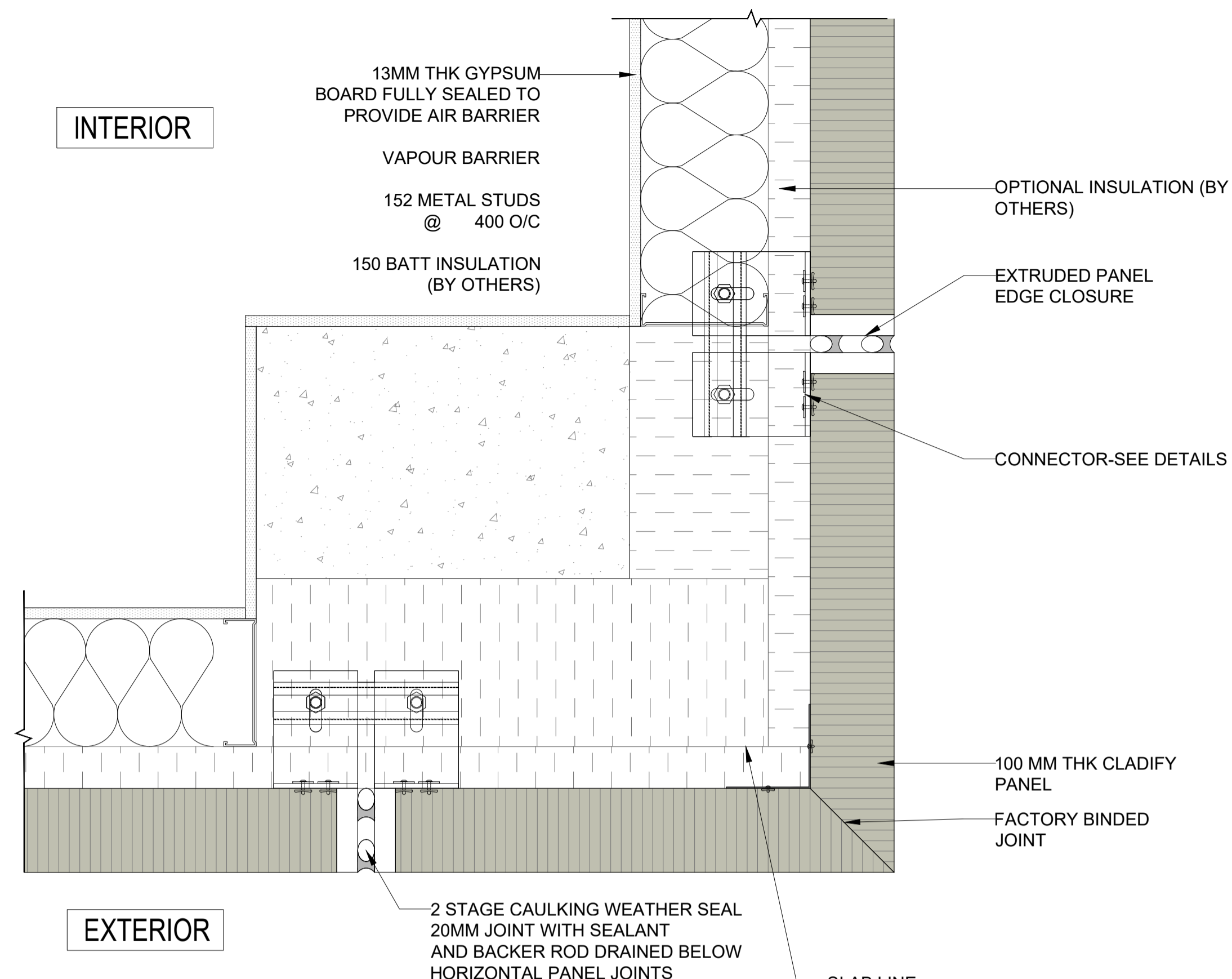

04 CORNER PANEL DETAIL (WITH RECESSED COLUMN)
PC-004 SCALE: 1:7.5

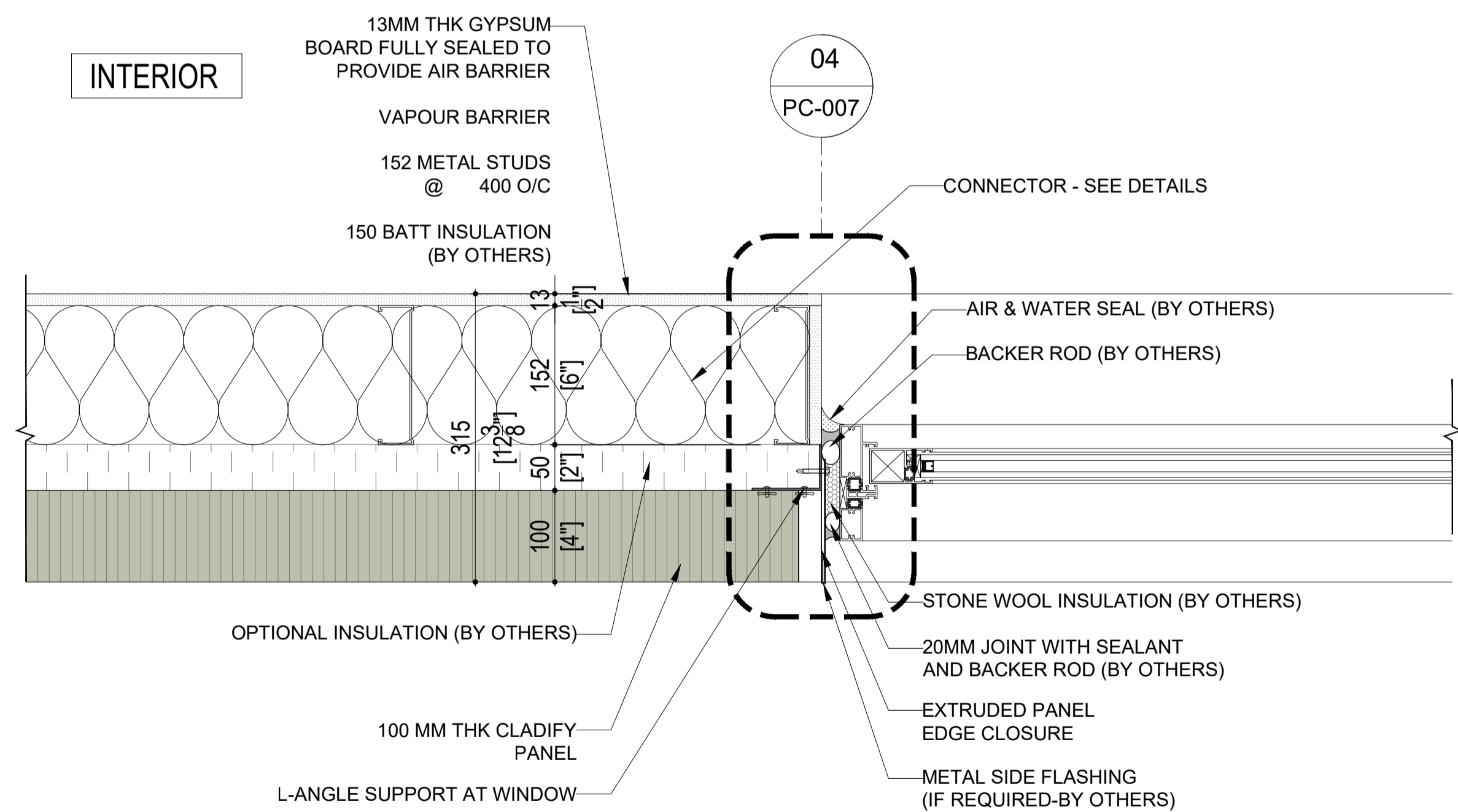

01 WINDOW JAMB DETAIL
PC-004 SCALE: 1:7.5

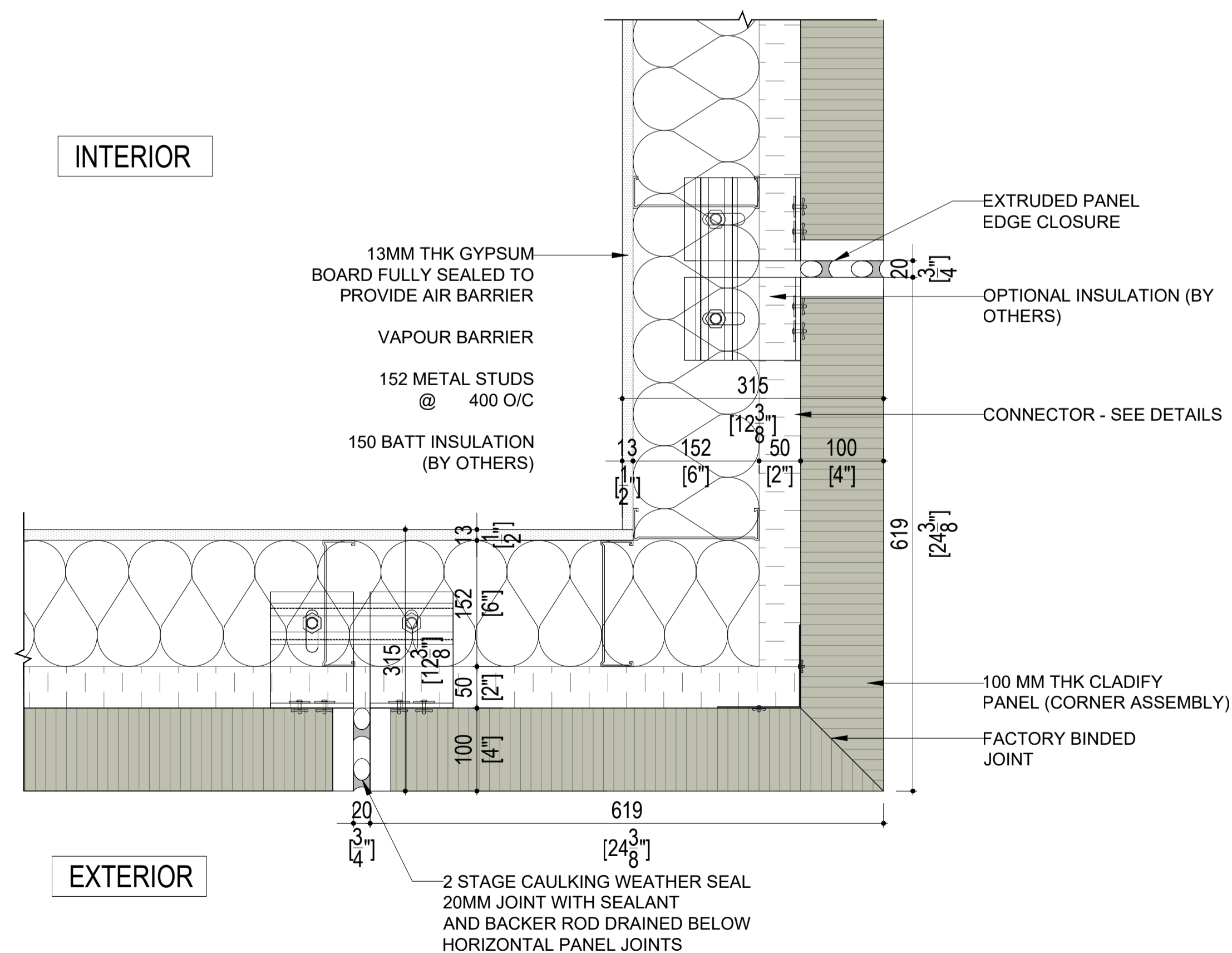

02 CORNER PANEL DETAIL (NO COLUMN)
PC-004 SCALE: 1:7.5

CONFIDENTIAL: ALL DRAWINGS ARE COPYRIGHT PROPERTY AND OWNED BY CLADIFY. ANY USE OR REPRODUCTION OF THESE DRAWINGS OR THE INFORMATION CONTAINED THEREIN WITHOUT THE EXPRESS WRITTEN PERMISSION OF CLADIFY, IS STRICTLY PROHIBITED.

- GENERAL NOTES:
- ALL DIMENSIONS, LEVELS, AND DETAILS WILL BE BASED ON ARCHITECTURAL DRAWINGS ISSUED BY DESIGNER.
 - ALL PANEL SIZES ARE BASED ON THE ARCHITECTURAL DRAWINGS, APPROVED SHOP DRAWINGS, AND SLAB EDGE MEASUREMENTS ISSUED.
 - ALL CLADIFY PANELS ARE PORCELAIN FACING WITH ALUMINUM HONEY COMB BACKING.

- NOTE:
- DUE TO THE SIZE OF THE PANELS, THE PRODUCTION MANAGER MAY SUGGEST THICKER ALUMINUM BACKING SYSTEM.
 - DUE TO THE SIZE OF THE PANELS, THE REQUIRED TEMPERATURE FOR INSTALLATION IS +12 °C.
 - ALL HORIZONTAL AND VERTICAL JOINTS ARE 20mm UNLESS NOTED OTHERWISE. MAKE UP ALONG ENTIRE LENGTH TO ACCOUNT FOR DIMENSIONAL ROUNDING OF INDIVIDUAL STONE LENGTHS.
 - SITE CUT STONE TO SUIT CONDITIONS ARE REQUIRED.
 - DO NOT SCALE DRAWING.
 - PANEL SIZE TOLERANCE IS -1-2 INCHES.
 - DUE TO WALL ASSEMBLY DEPTH, CLADDING SYSTEM MAY VARY.
 - SYSTEM SIZE TO BE CONFIRMED.
 - PENETRATIONS TO BE SEALED.

ABBREVIATIONS:

CL = CLADIFY	E/O = END OF
T/O = TOP OF	C/O = CORNER OF
B/O = BOTTOM OF	TYP = TYPICAL
REF. = REFERENCE/REFER	SIM. = SIMILAR
M/E = MITERED EDGE	F/O = FACE OF

SEAL

REV.	YY-MM-DD	DESCRIPTION
0	2023-08-22	INITIAL SHOP DRAWINGS

ARCHITECT

CLIENT

PROJECT TITLE
CladiCast
LIGHT WEIGHT PRECAST SOLUTION

SHEET TITLE
PLAN DETAILS

INFORMATION
DATE: 2023-08-22
SCALE: AS INDICATED
DRAWN BY: GC
MEASURED BY:
CHECKED BY: AR / AS

DRAWING NO:
PC-004-A

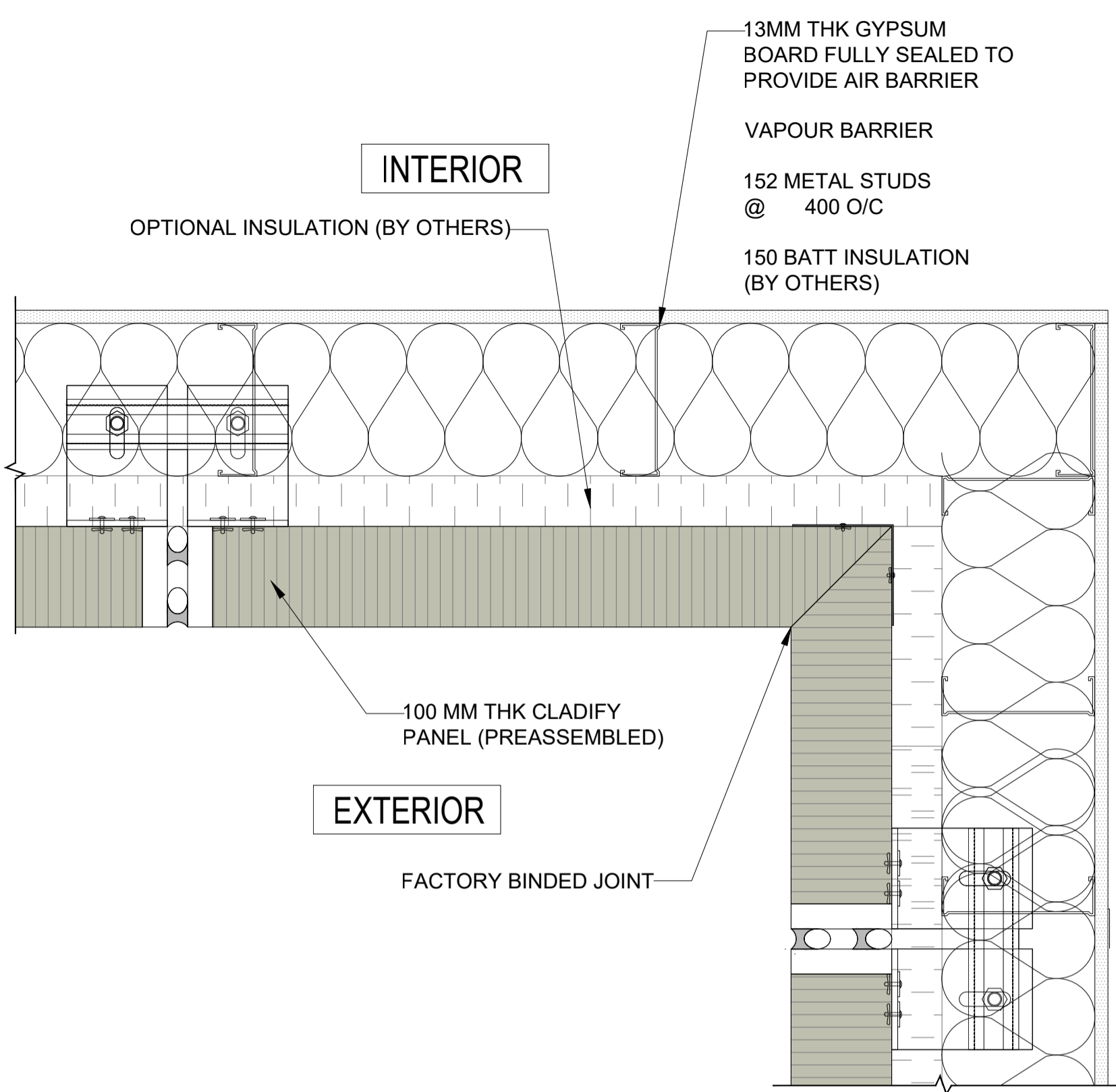

03 INNER CORNER PANEL AT BALCONY (1)
PC-004-A SCALE: 1:7.5

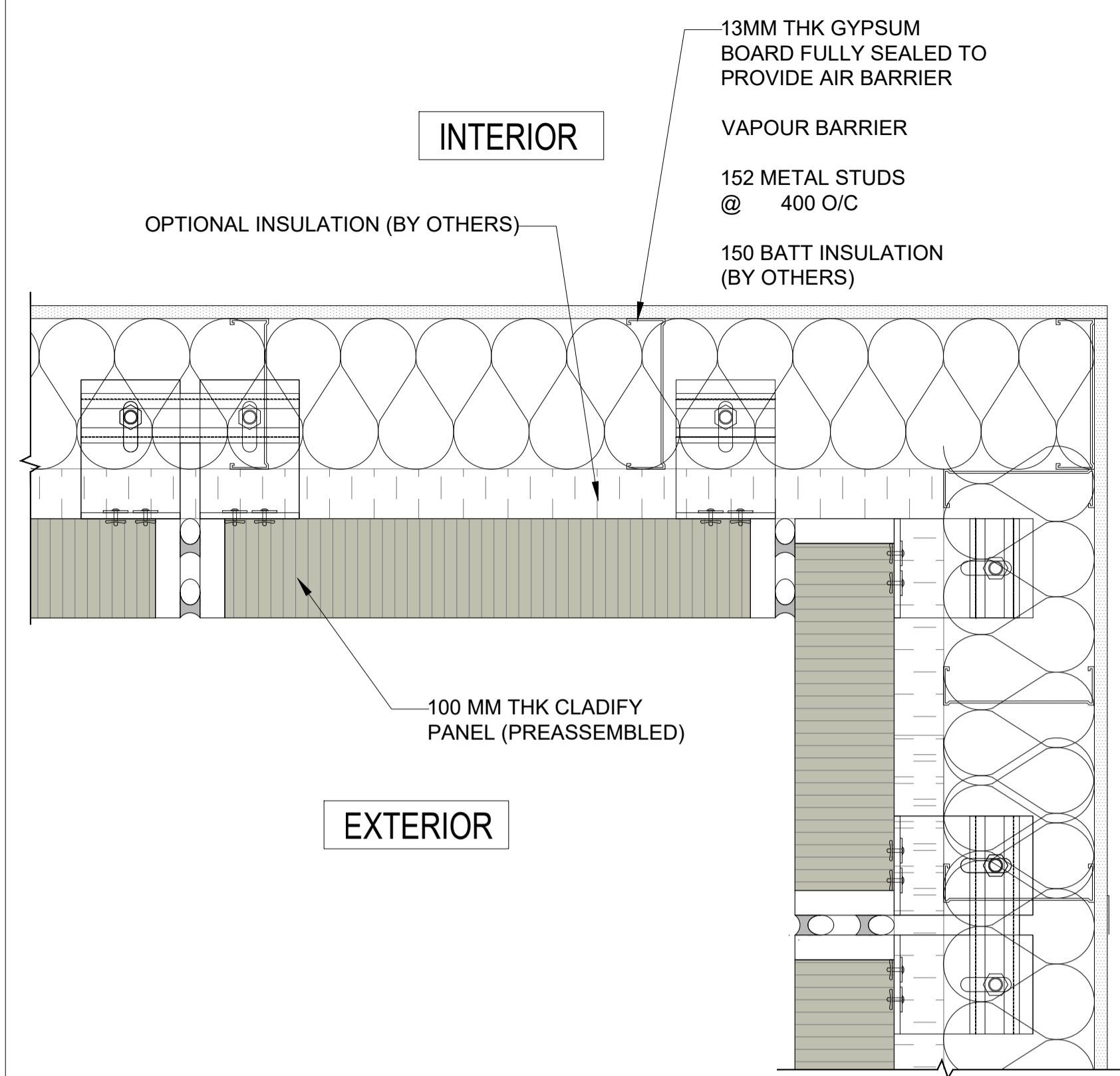

04 INNER CORNER PANEL AT BALCONY (2)
PC-004-A SCALE: 1:7.5

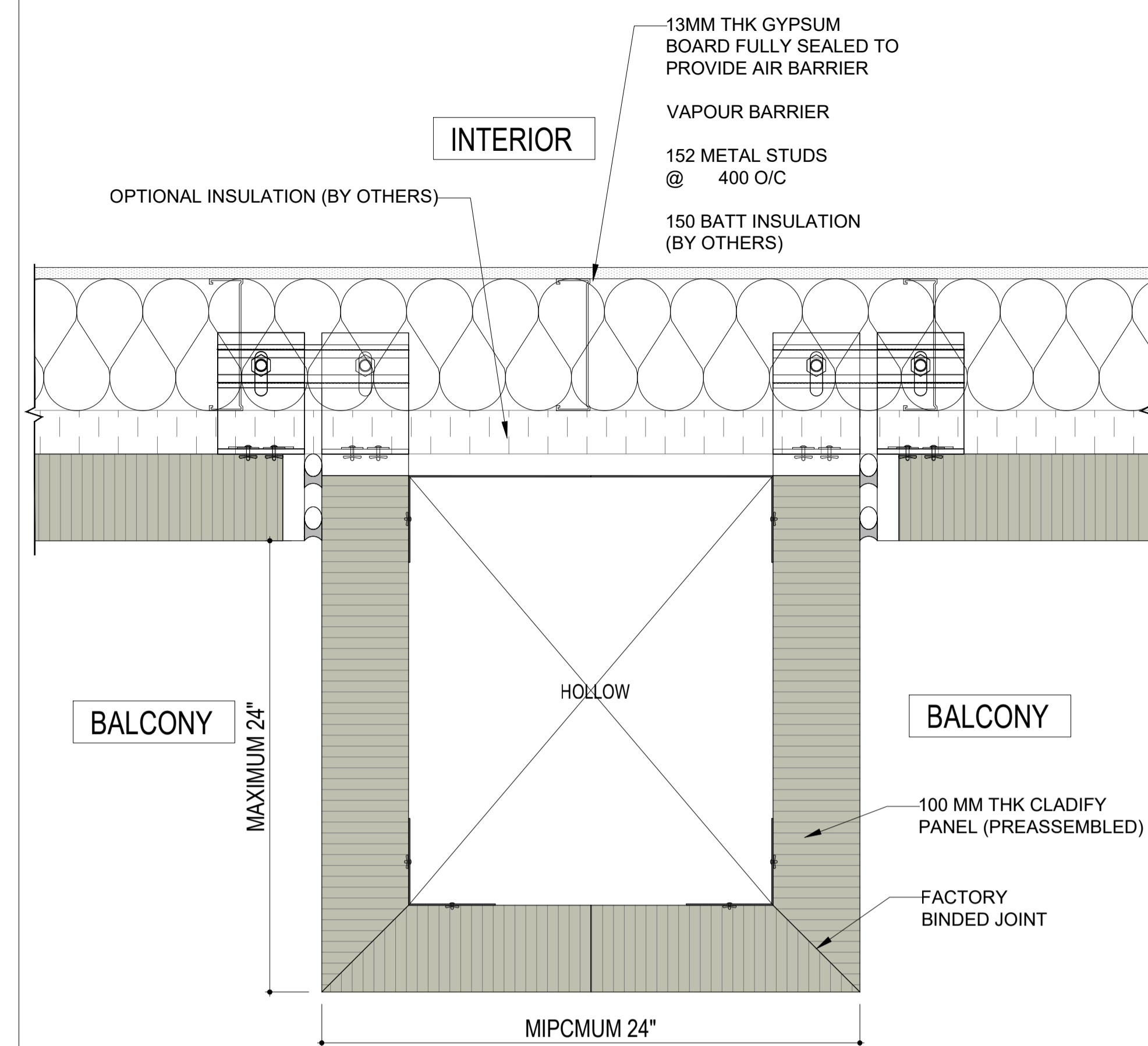

05 WALL PROTRUSION DETAIL
PC-004-A SCALE: 1:7.5

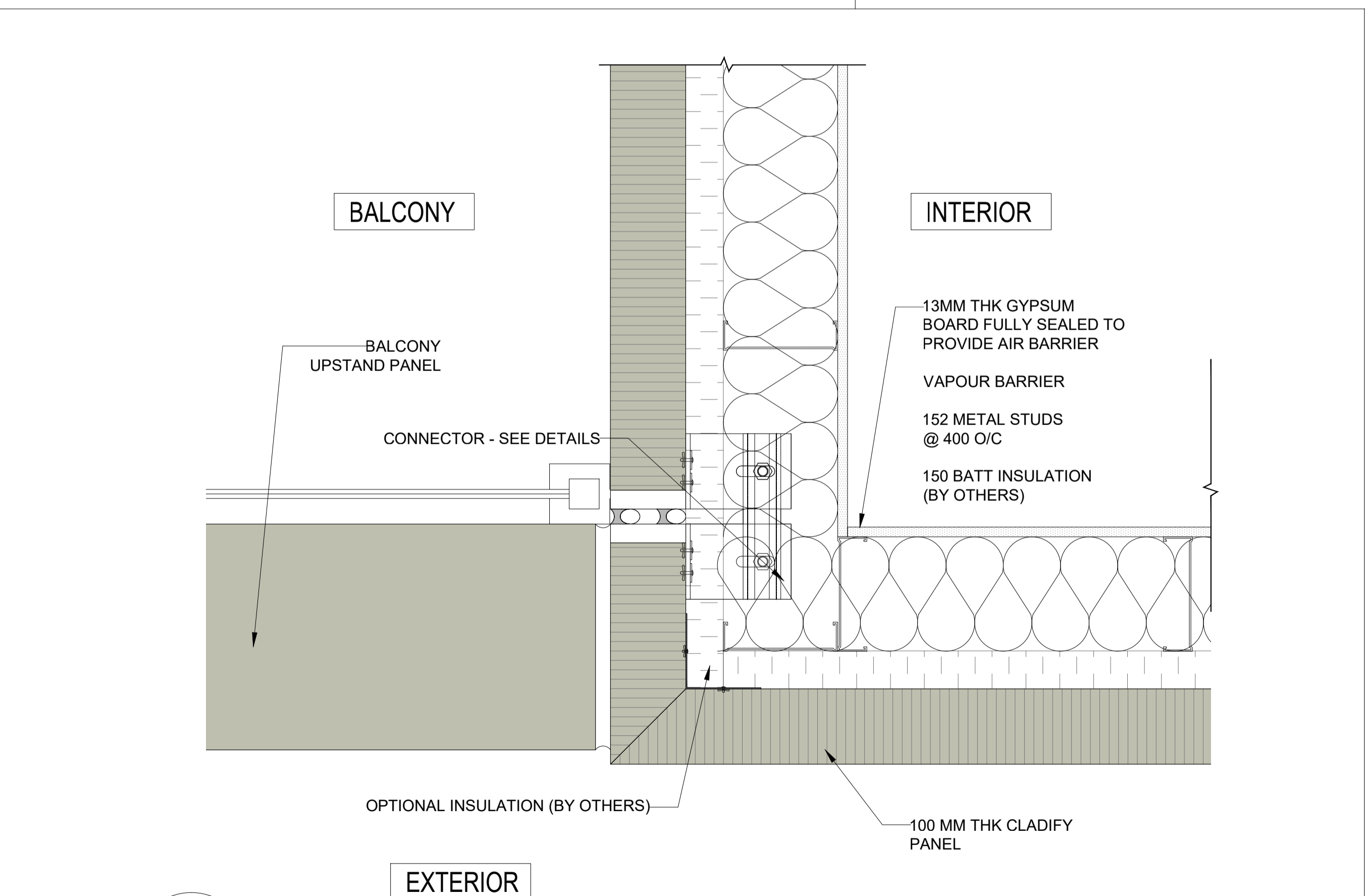

01 CORNER PANEL AT BALCONY
PC-004-A SCALE: 1:7.5

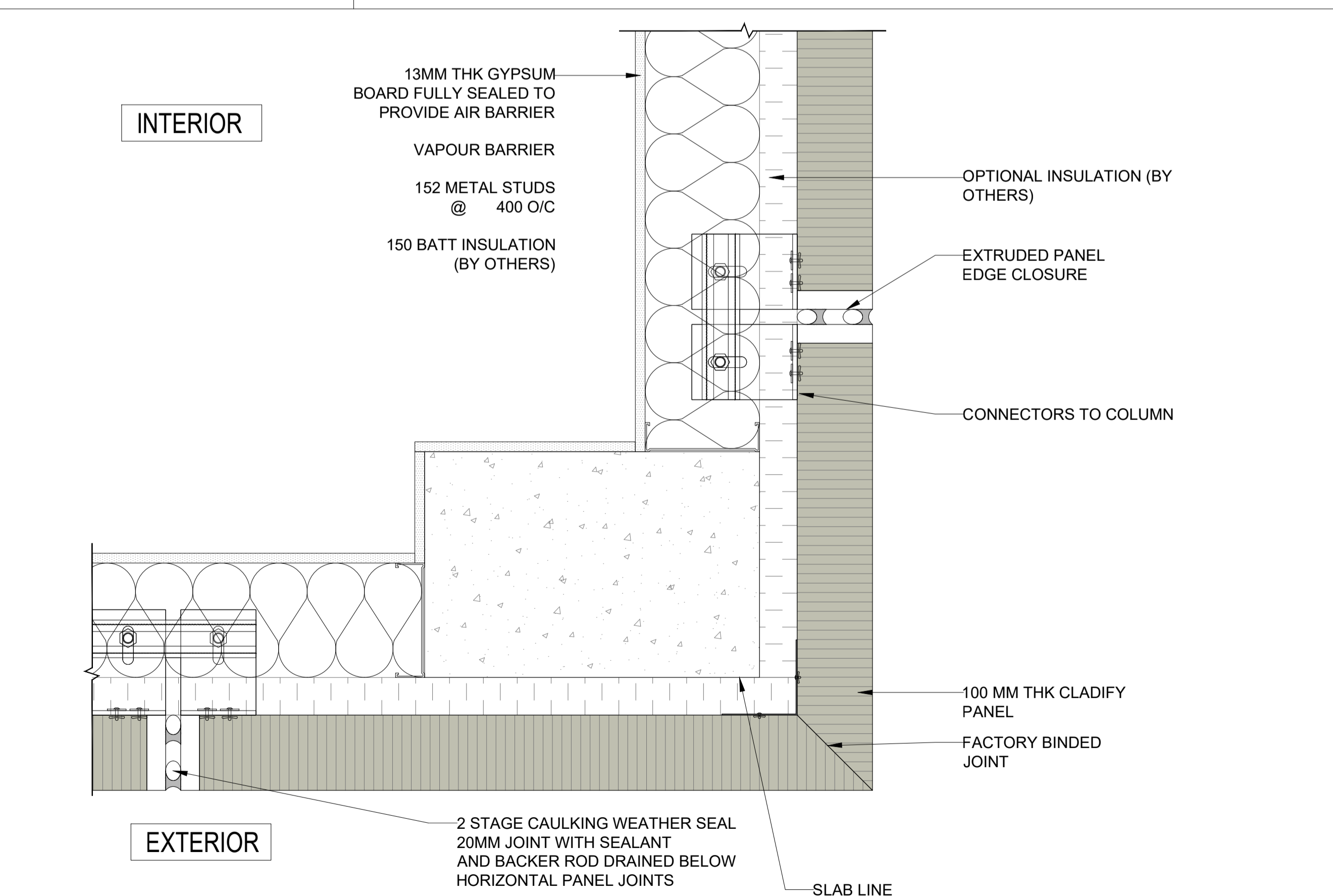

02 CORNER PANEL DETAIL (WITH FLUSHED COLUMN)
PC-004-A SCALE: 1:7.5

CONFIDENTIAL: ALL DRAWINGS ARE COPYRIGHT PROPERTY AND OWNED BY CLADIFY. ANY USE OR REPRODUCTION OF THESE DRAWINGS OR THE INFORMATION CONTAINED THEREIN WITHOUT THE EXPRESS WRITTEN PERMISSION OF CLADIFY, IS STRICTLY PROHIBITED.

- GENERAL NOTES:
- ALL DIMENSIONS, LEVELS, AND DETAILS WILL BE BASED ON ARCHITECTURAL DRAWINGS ISSUED BY DESIGNER.
 - ALL PANEL SIZES ARE BASED ON THE ARCHITECTURAL DRAWINGS, APPROVED SHOP DRAWINGS, AND SLAB EDGE MEASUREMENTS ISSUED.
 - ALL CLADIFY PANELS ARE PORCELAIN FACING WITH ALUMINUM HONEY COMB BACKING.
- NOTE:
- DUE TO THE SIZE OF THE PANELS, THE PRODUCTION MANAGER MAY SUGGEST THICKER ALUMINUM BACKING SYSTEM.
 - DUE TO THE SIZE OF THE PANELS, THE REQUIRED TEMPERATURE FOR INSTALLATION IS +12 °C.
 - ALL HORIZONTAL AND VERTICAL JOINTS ARE 20mm UNLESS NOTED OTHERWISE. MAKE UP ALONG ENTIRE LENGTH TO ACCOUNT FOR DIMENSIONAL ROUNDING OF INDIVIDUAL STONE LENGTHS.
 - SITE CUT STONE TO SUIT CONDITIONS ARE REQUIRED.
 - DO NOT SCALE DRAWING.
 - PANEL SIZE TOLERANCE IS -1-2 INCHES
 - DUE TO WALL ASSEMBLY DEPTH, CLADDING SYSTEM MAY VARY.
 - SYSTEM SIZE TO BE CONFIRMED.
 - PENETRATIONS TO BE SEALED

ABBREVIATIONS:

CL = CLADIFY
T/O = TOP OF
B/O = BOTTOM OF
REF. = REFERENCE/REFER
M/E = MITERED EDGE

E/O = END OF
C/O = CORNER OF
TYP = TYPICAL
SIM = SIMILAR
F/O = FACE OF

SEAL

0	2023-08-22	INITIAL SHOP DRAWINGS
---	------------	-----------------------

REV. YY-MM-DD DESCRIPTION

ARCHITECT

CLIENT

PROJECT TITLE

CladiCast
LIGHT WEIGHT PRECAST SOLUTION

SHEET TITLE

DETAILS

INFORMATION

DATE: 2023-08-22
SCALE: AS INDICATED
DRAWN BY: GC
MEASURED BY:
CHECKED BY: AR / AS

DRAWING NO:

PC-006

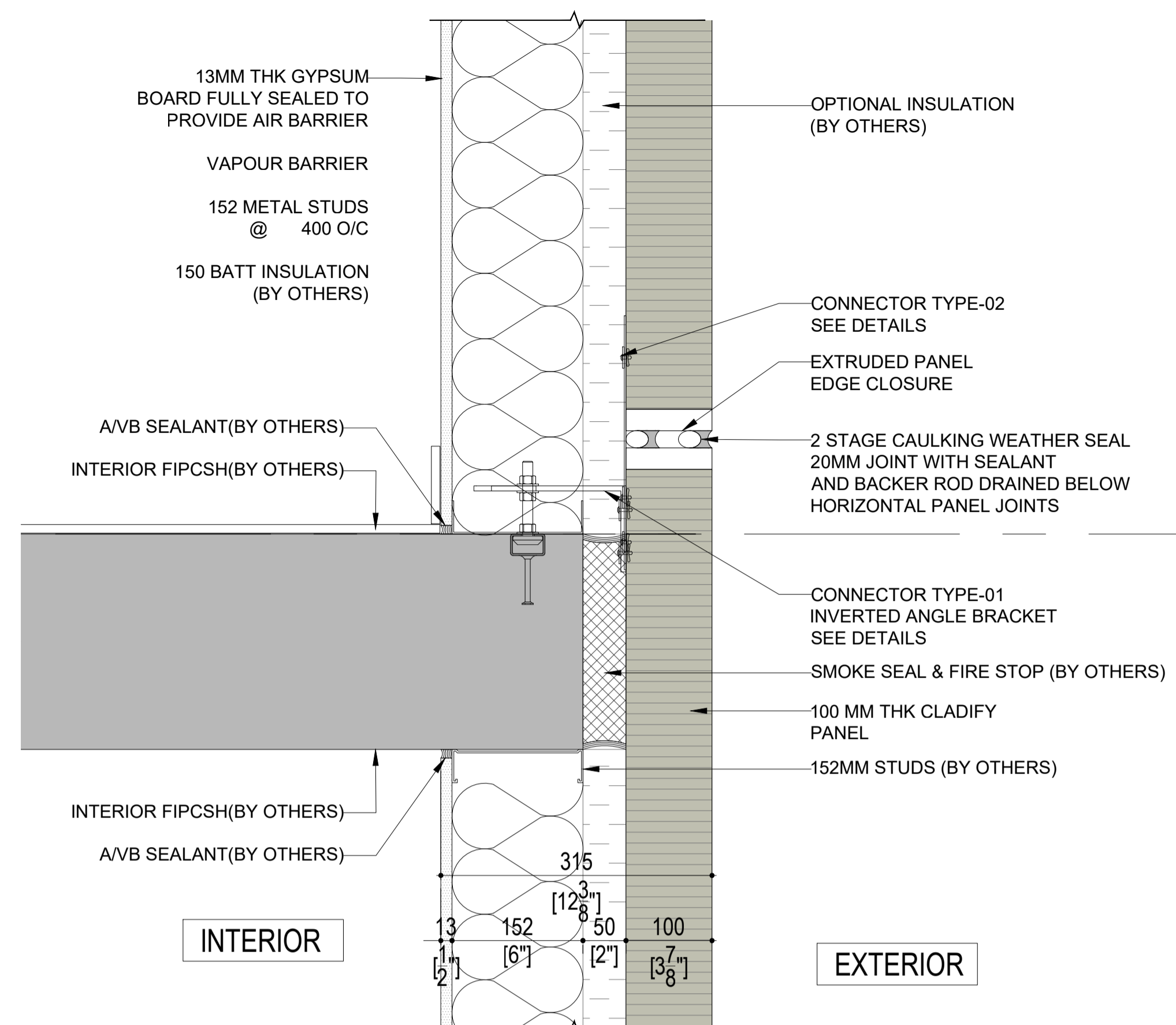

02 PANEL HORIZONTAL LOW JOINT DETAIL
PC-006 SCALE: 1:7.5

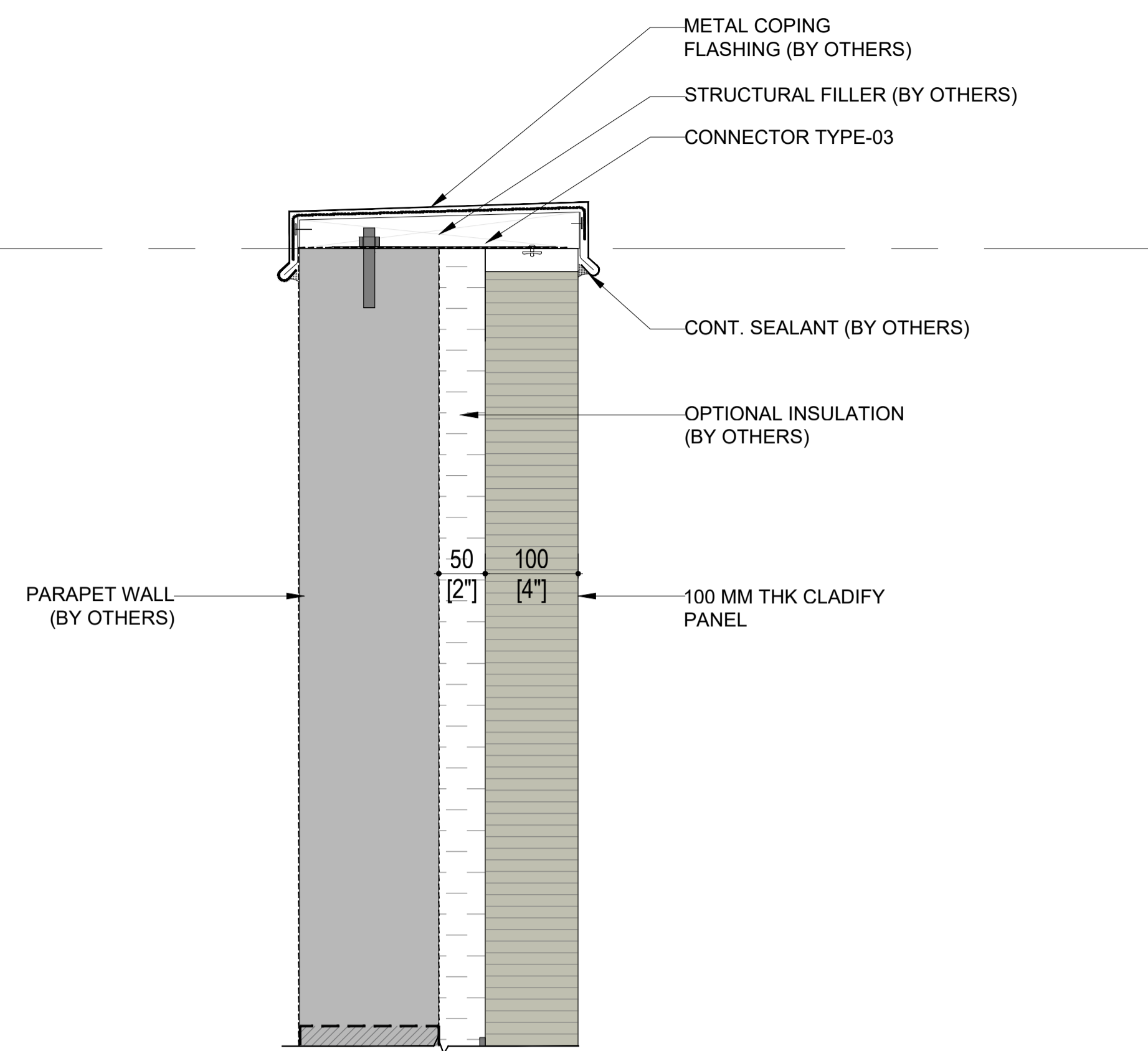

04 PANEL AT PARAPET DETAIL
PC-006 SCALE: 1:7.5

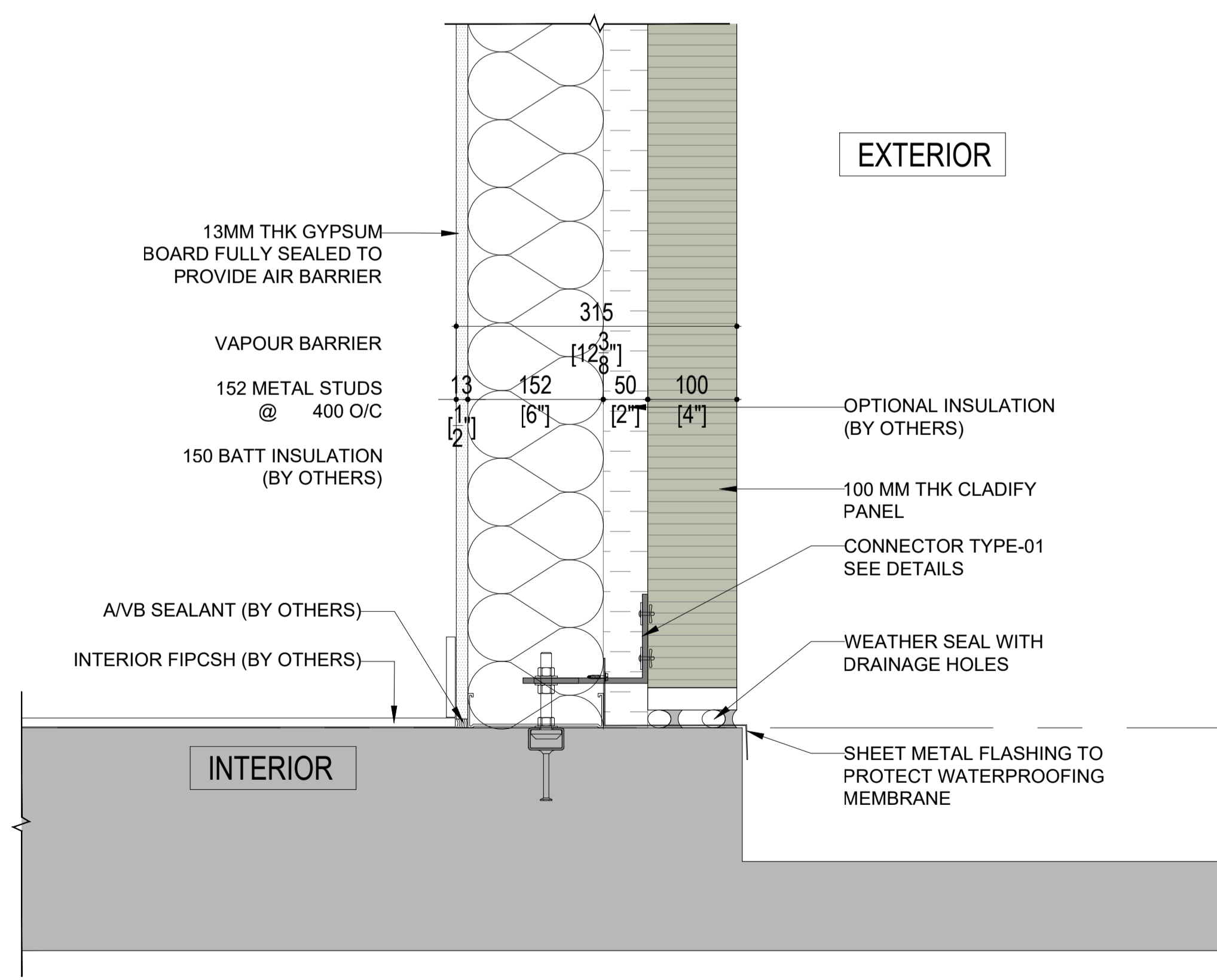

01 PANEL AT BASE DETAIL
PC-006 SCALE: 1:7.5

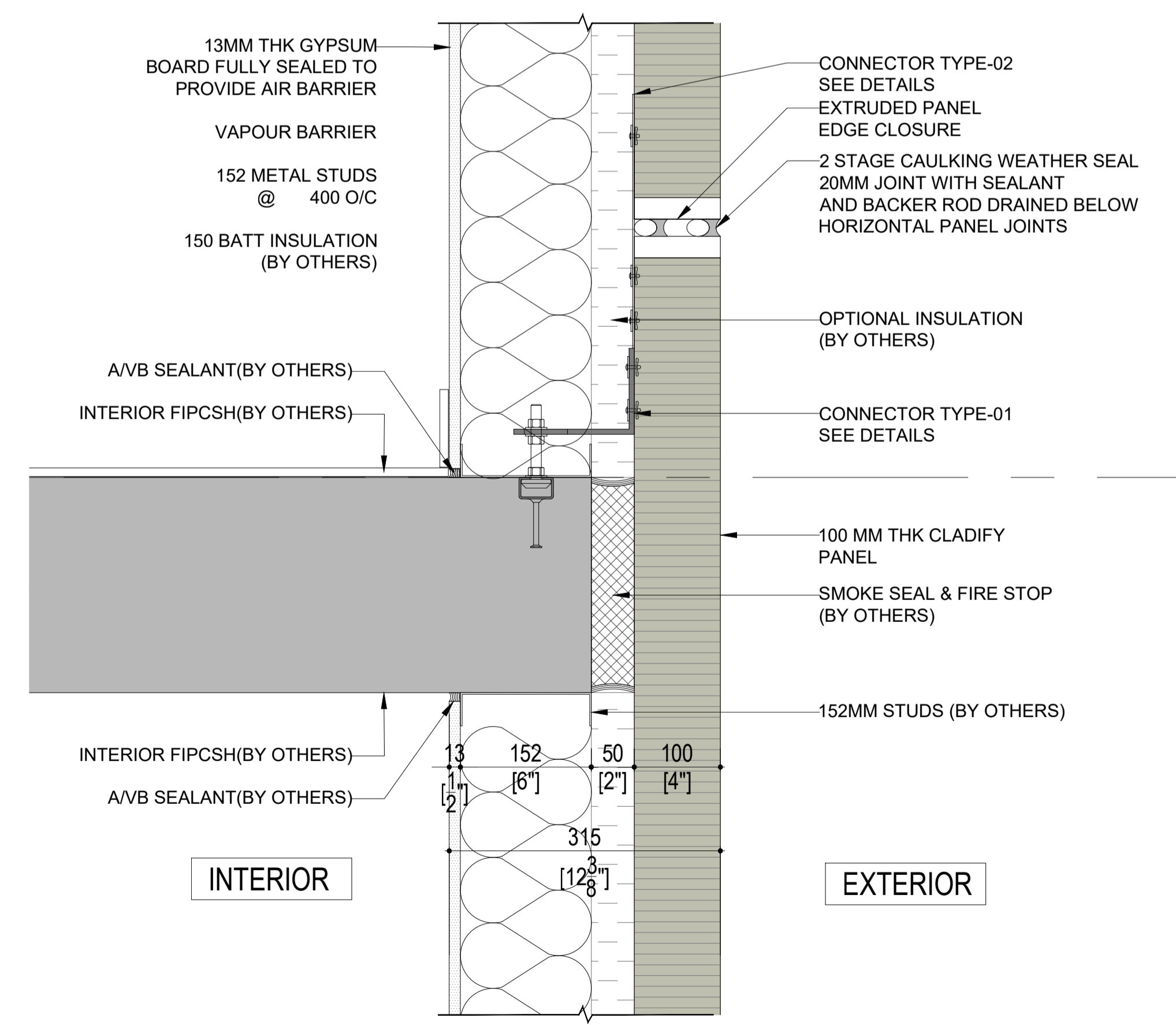

03 PAENL HORIZONTAL HIGH JOINT DETAIL
PC-006 SCALE: 1:7.5

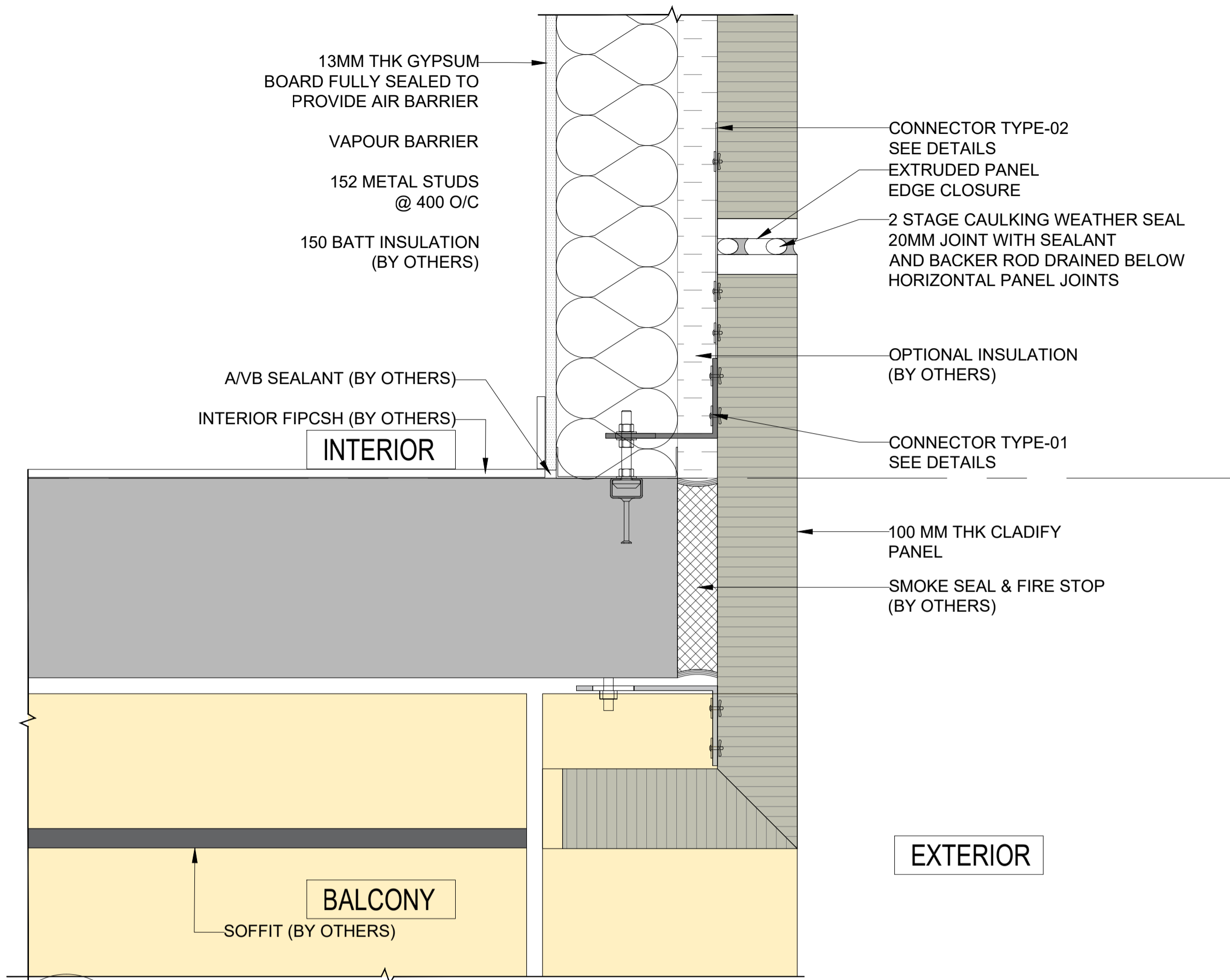

02 PANEL RETURN AT BALCONY SOFFIT DETAIL
 PC-007 SCALE: 1:7.5

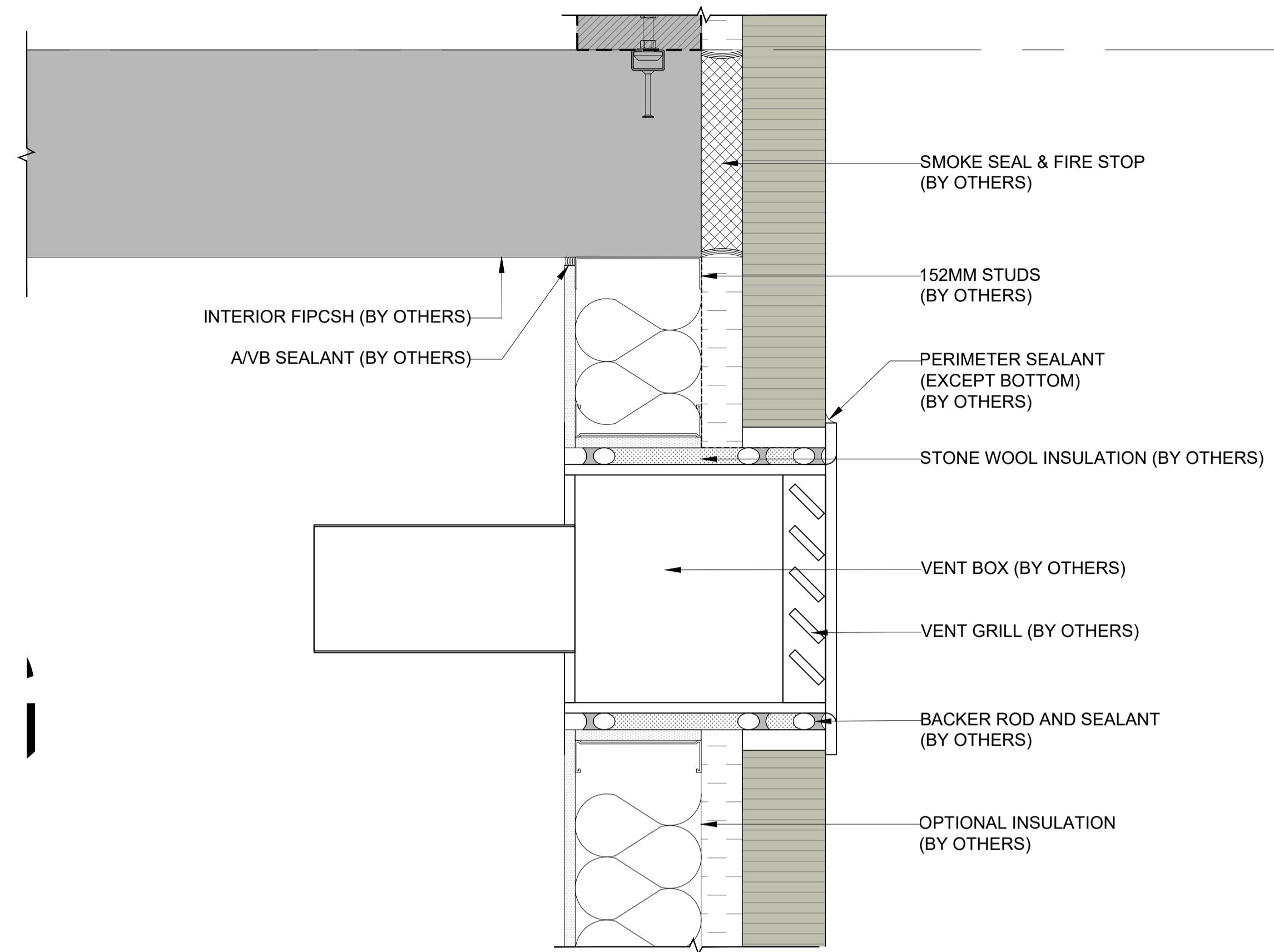

03 MECH'L. OPEPCNG AT PANEL DETAIL
 PC-007 SCALE: 1:7.5

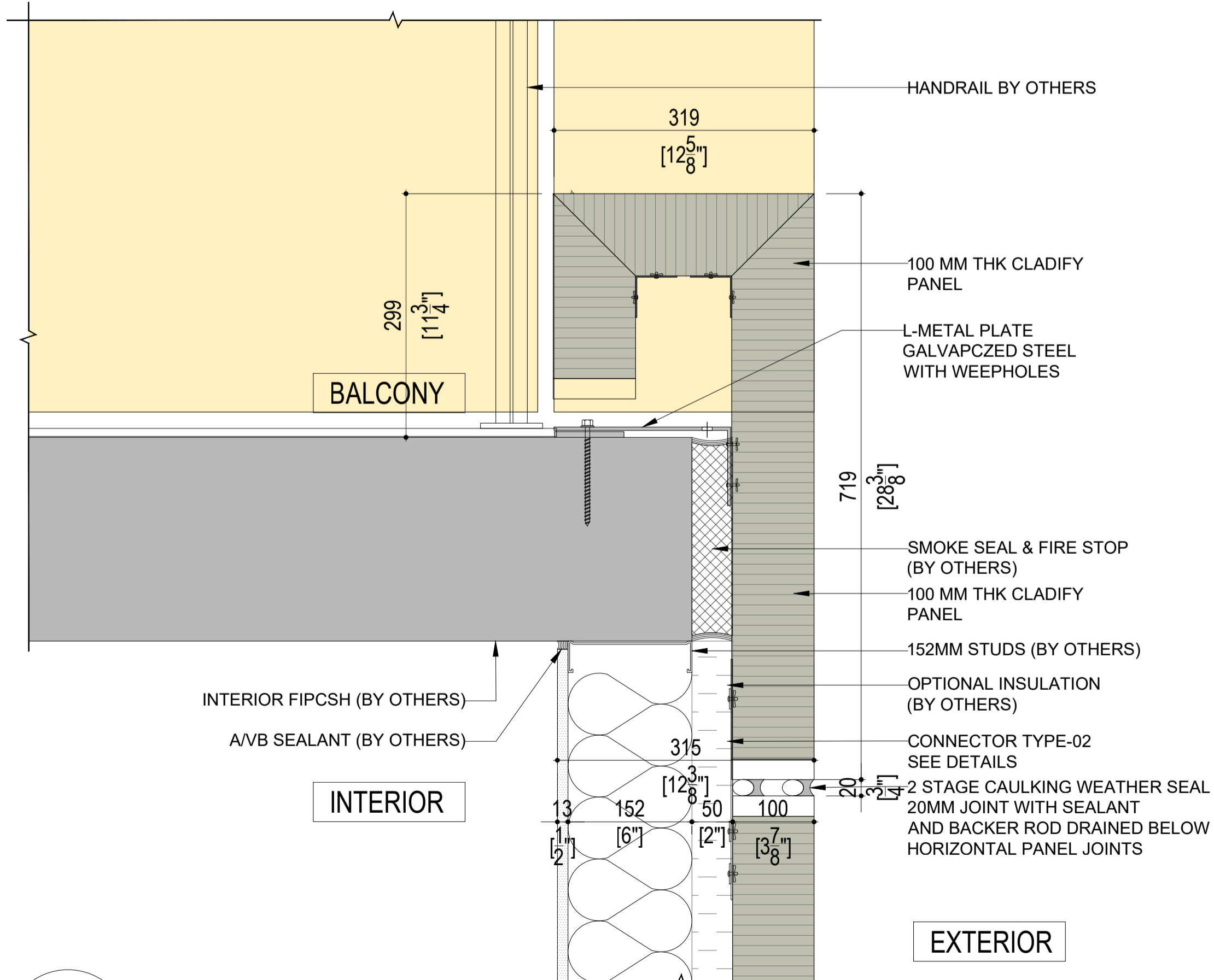

01 PANEL AT BALCONY UPSTAND DETAIL
 PC-007 SCALE: 1:7.5

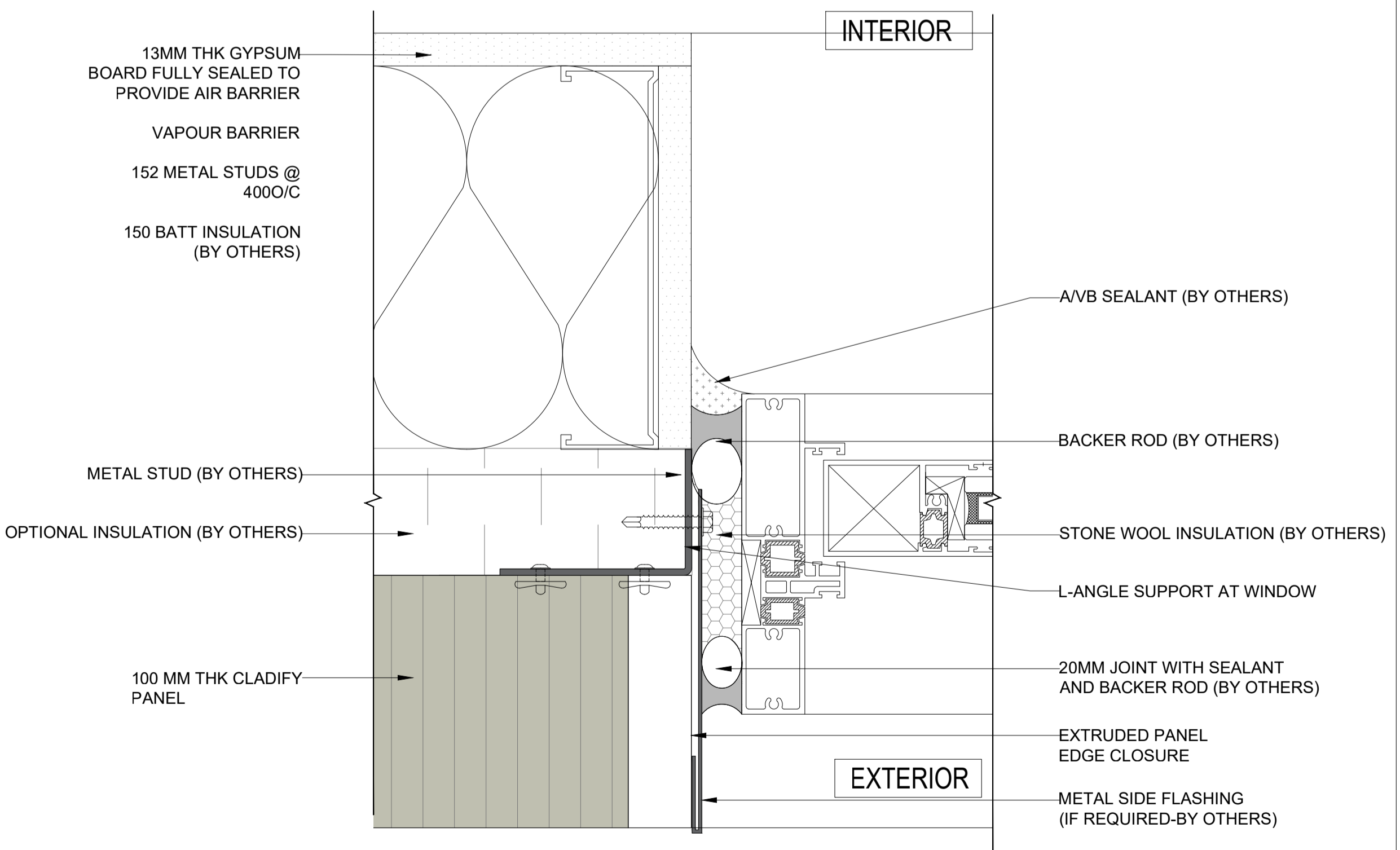

04 WINDOW SIDE ENLARGED DETAIL
 PC-007 SCALE: 1:2.5

CONFIDENTIAL: ALL DRAWINGS ARE COPYRIGHT PROPERTY AND OWNED BY CLADIFY. ANY USE OR REPRODUCTION OF THESE DRAWINGS OR THE INFORMATION CONTAINED THEREIN WITHOUT THE EXPRESS WRITTEN PERMISSION OF CLADIFY, IS STRICTLY PROHIBITED.

- GENERAL NOTES:
- ALL DIMENSIONS, LEVELS, AND DETAILS WILL BE BASED ON ARCHITECTURAL DRAWINGS ISSUED BY DESIGNER.
 - ALL PANEL SIZES ARE BASED ON THE ARCHITECTURAL DRAWINGS, APPROVED SHOP DRAWINGS, AND SLAB EDGE MEASUREMENTS ISSUED.
 - ALL CLADIFY PANELS ARE PORCELAIN FACING WITH ALUMINUM HONEY COMB BACKING.
- NOTE:
- DUE TO THE SIZE OF THE PANELS, THE PRODUCTION MANAGER MAY SUGGEST THICKER ALUMINUM BACKING SYSTEM.
 - DUE TO THE SIZE OF THE PANELS, THE REQUIRED TEMPERATURE FOR INSTALLATION IS +12 °C.
 - ALL HORIZONTAL AND VERTICAL JOINTS ARE 20mm UNLESS NOTED OTHERWISE. MAKE UP ALONG ENTIRE LENGTH TO ACCOUNT FOR DIMENSIONAL ROUNDING OF INDIVIDUAL STONE LENGTHS.
 - SITE CUT STONE TO SUIT CONDITIONS ARE REQUIRED.
 - DO NOT SCALE DRAWING.
 - PANEL SIZE TOLERANCE IS -1-2 INCHES
 - DUE TO WALL ASSEMBLY DEPTH, CLADDING SYSTEM MAY VARY.
 - SYSTEM SIZE TO BE CONFIRMED.
 - PENETRATIONS TO BE SEALED

ABBREVIATIONS:

CL = CLADIFY	E/O = END OF
T/O = TOP OF	C/O = CORNER OF
B/O = BOTTOM OF	TYP = TYPICAL
REF. = REFERENCE/REFER	SIM. = SIMILAR
M/E = MITERED EDGE	F/O = FACE OF

SEAL

REV.	YY-MM-DD	DESCRIPTION
0	2023-08-22	INITIAL SHOP DRAWINGS

ARCHITECT

CLIENT

PROJECT TITLE
CladiCast
 LIGHT WEIGHT PRECAST SOLUTION

SHEET TITLE
 DETAILS

INFORMATION
 DATE: 2023-08-22
 SCALE: AS INDICATED
 DRAWN BY: GC
 MEASURED BY:
 CHECKED BY: AR / AS

DRAWING NO:
PC-007

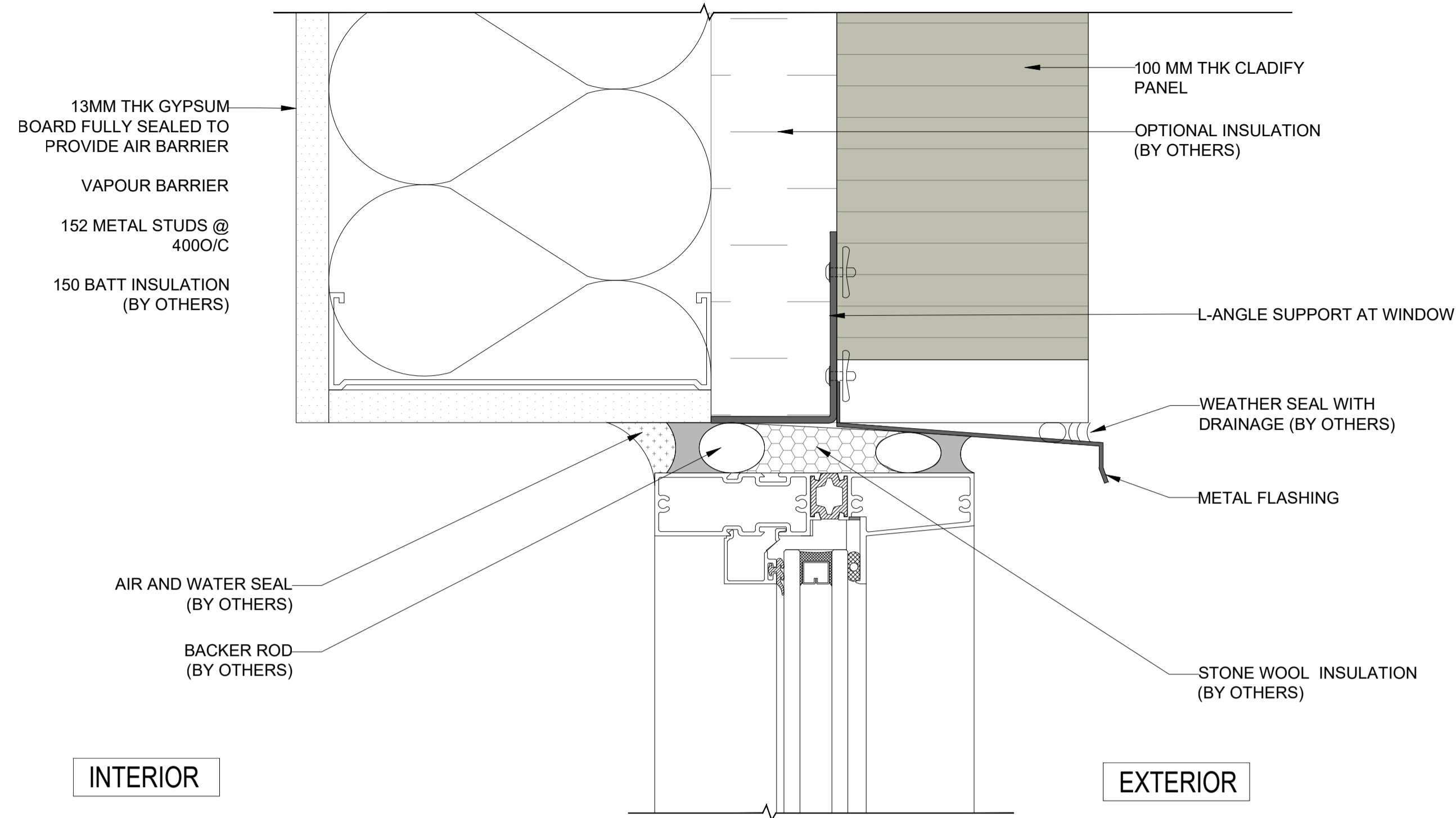

INTERIOR

EXTERIOR

02 WINDOW HEADER DETAIL
PC-008 SCALE: 1:2.5

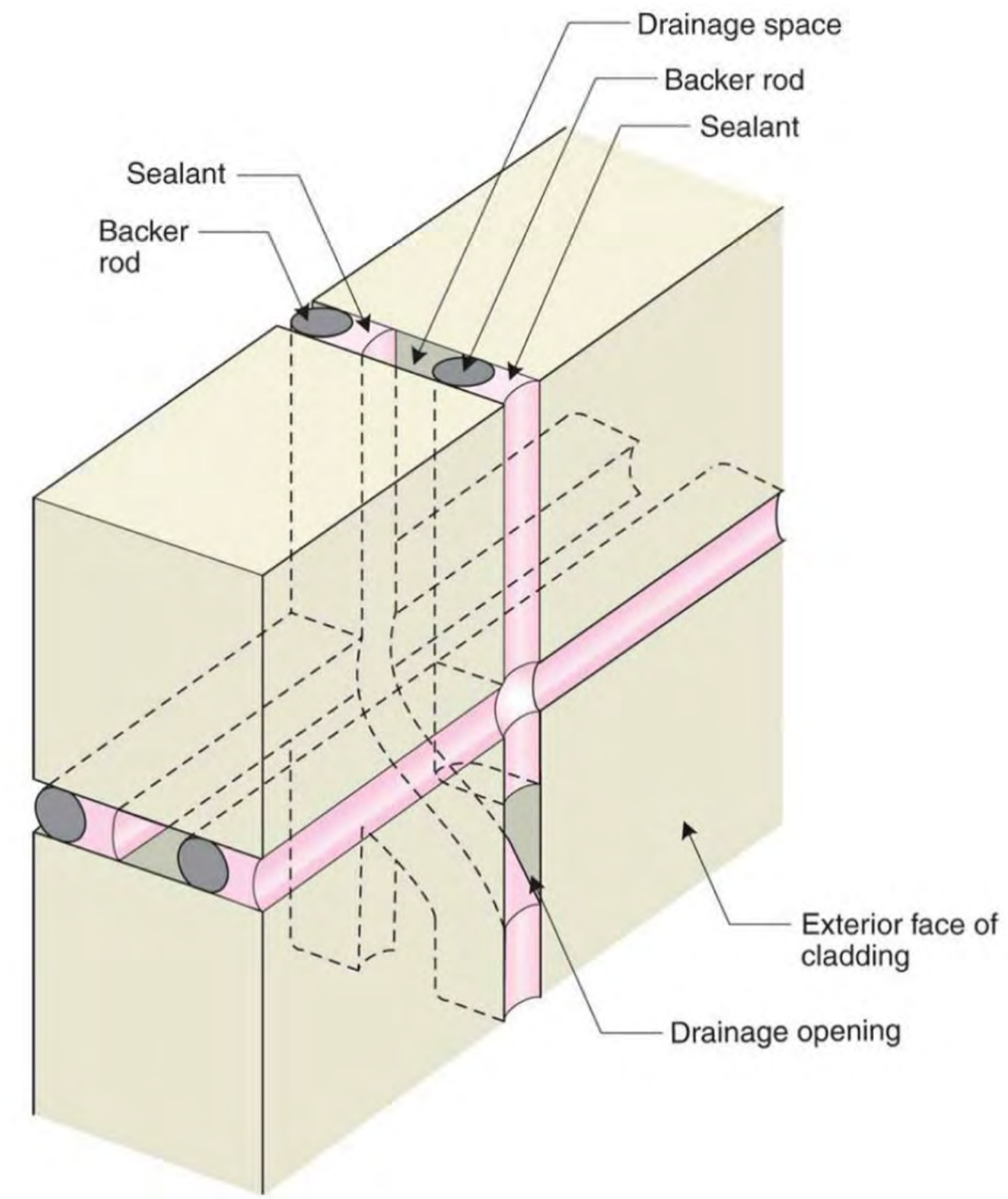

04 CONCEPT OF 2 STAGE CAULKING OF CLADIFY PANELS
PC-008 NDTs

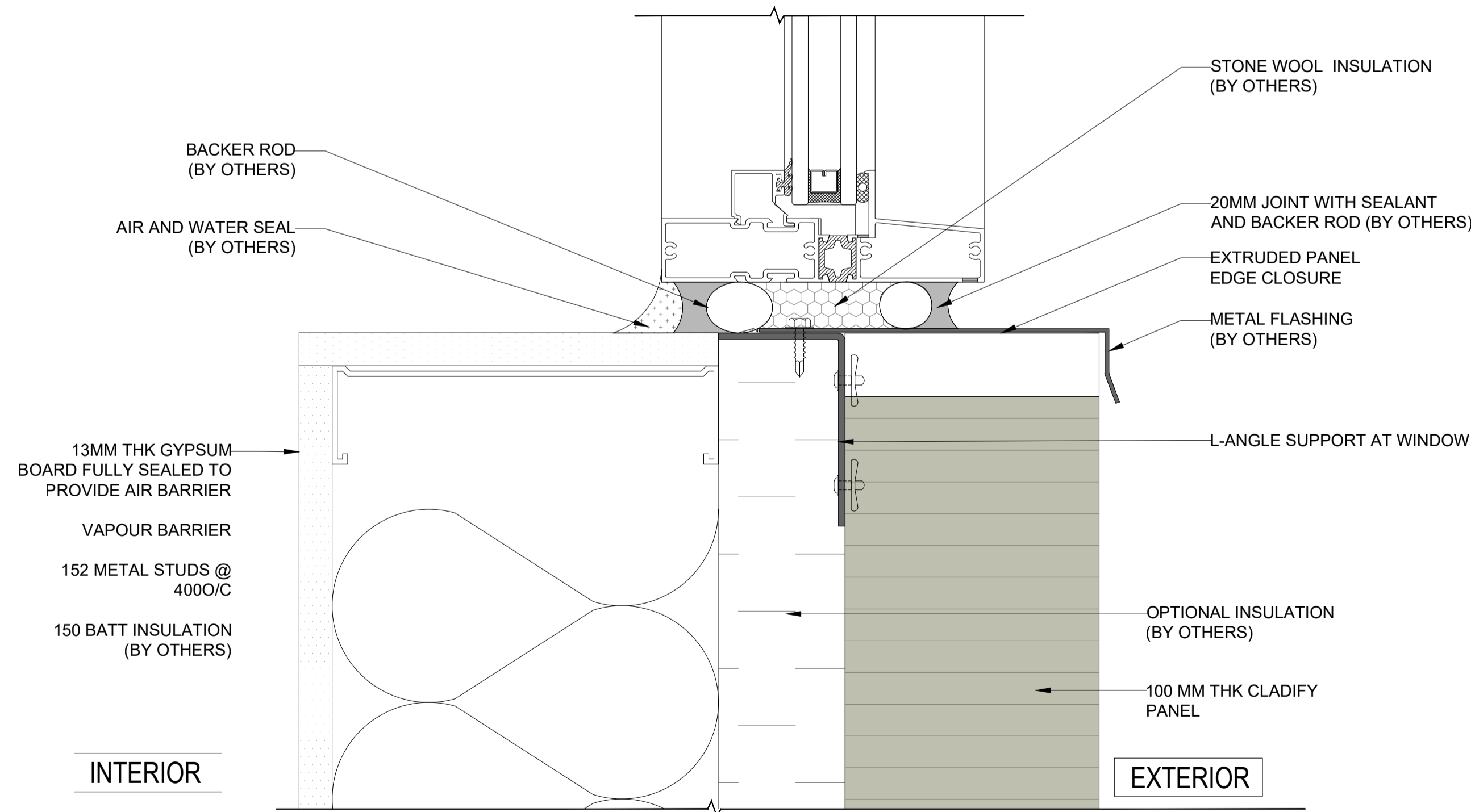

INTERIOR

EXTERIOR

01 WINDOW SILL DETAIL
PC-008 SCALE: 1:2.5

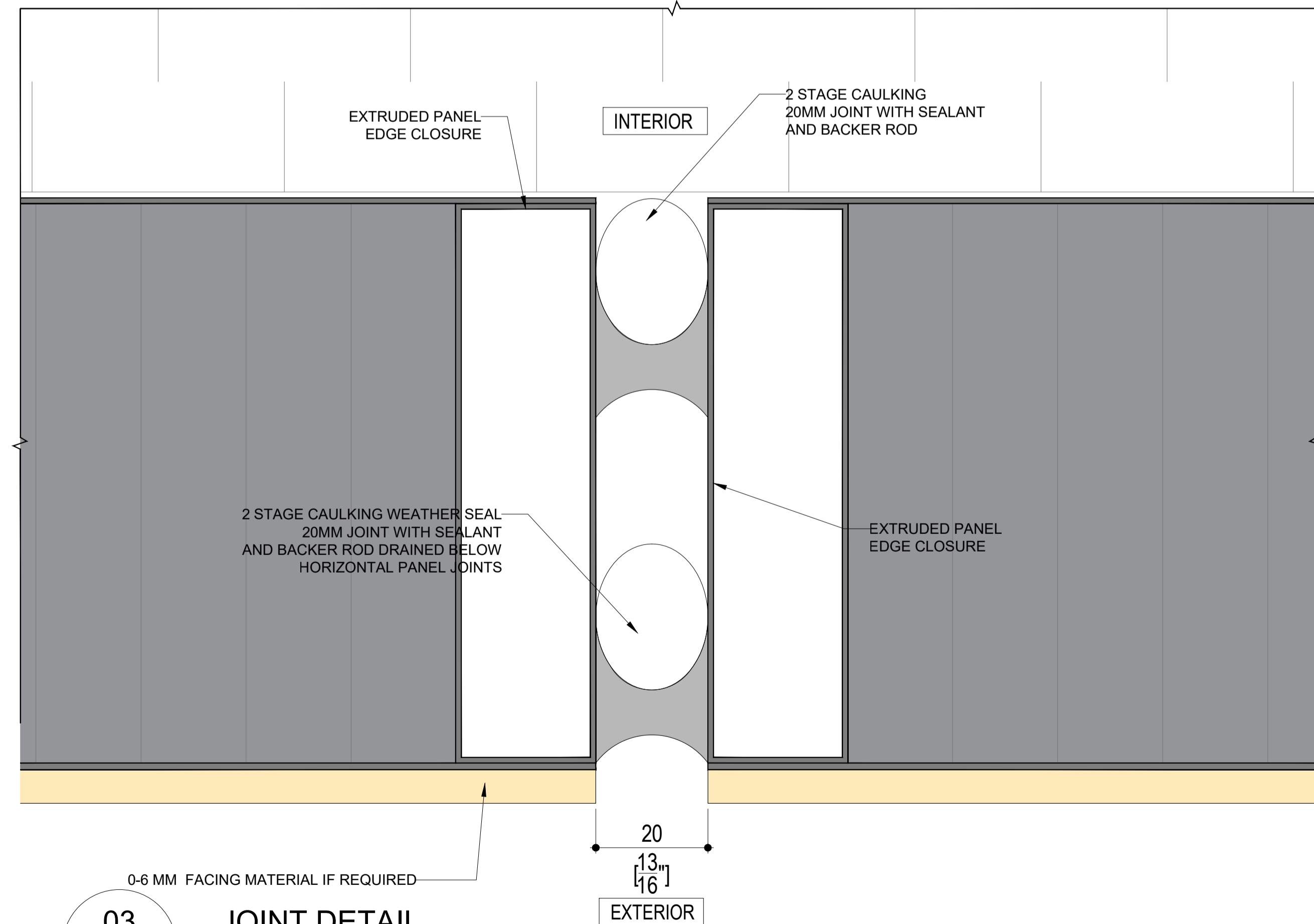

03 JOINT DETAIL
PC-008 SCALE: 1:1

CONFIDENTIAL: ALL DRAWINGS ARE COPYRIGHT PROPERTY AND OWNED BY CLADIFY. ANY USE OR REPRODUCTION OF THESE DRAWINGS OR THE INFORMATION CONTAINED THEREIN WITHOUT THE EXPRESS WRITTEN PERMISSION OF CLADIFY, IS STRICTLY PROHIBITED.

- GENERAL NOTES:
- ALL DIMENSIONS, LEVELS, AND DETAILS WILL BE BASED ON ARCHITECTURAL DRAWINGS ISSUED BY DESIGNER.
 - ALL PANEL SIZES ARE BASED ON THE ARCHITECTURAL DRAWINGS, APPROVED SHOP DRAWINGS, AND SLAB EDGE MEASUREMENTS ISSUED.
 - ALL CLADIFY PANELS ARE PORCELAIN FACING WITH ALUMINUM HONEY COMB BACKING.

- NOTE:
- DUE TO THE SIZE OF THE PANELS, THE PRODUCTION MANAGER MAY SUGGEST THICKER ALUMINUM BACKING SYSTEM.
 - DUE TO THE SIZE OF THE PANELS, THE REQUIRED TEMPERATURE FOR INSTALLATION IS +12 °C.
 - ALL HORIZONTAL AND VERTICAL JOINTS ARE 20mm UNLESS NOTED OTHERWISE. MAKE UP ALONG ENTIRE LENGTH TO ACCOUNT FOR DIMENSIONAL ROUNDING OF INDIVIDUAL STONE LENGTHS.
 - SITE CUT STONE TO SUIT CONDITIONS ARE REQUIRED.
 - DO NOT SCALE DRAWING.
 - PANEL SIZE TOLERANCE IS -1-2 INCHES.
 - DUE TO WALL ASSEMBLY DEPTH, CLADDING SYSTEM MAY VARY.
 - SYSTEM SIZE TO BE CONFIRMED.
 - PENETRATIONS TO BE SEALED.

ABBREVIATIONS:

CL = CLADIFY	E/O = END OF
T/O = TOP OF	C/O = CORNER OF
B/O = BOTTOM OF	TYP = TYPICAL
REF. = REFERENCE/REFER	SIM. = SIMILAR
M/E = MITERED EDGE	F/O = FACE OF

SEAL

REV.	YY-MM-DD	DESCRIPTION
0	2023-08-22	INITIAL SHOP DRAWINGS

ARCHITECT

CLIENT

PROJECT TITLE
CladiCast
LIGHT WEIGHT PRECAST SOLUTION

SHEET TITLE
DETAILS

INFORMATION
DATE: 2023-08-22
SCALE: AS INDICATED
DRAWN BY: GC
MEASURED BY:
CHECKED BY: AR / AS

DRAWING NO:
PC-008

CONFIDENTIAL: ALL DRAWINGS ARE COPYRIGHT PROPERTY AND OWNED BY CLADIFY. ANY USE OR REPRODUCTION OF THESE DRAWINGS OR THE INFORMATION CONTAINED THEREIN WITHOUT THE EXPRESS WRITTEN PERMISSION OF CLADIFY, IS STRICTLY PROHIBITED.

- GENERAL NOTES:
- ALL DIMENSIONS, LEVELS, AND DETAILS WILL BE BASED ON ARCHITECTURAL DRAWINGS ISSUED BY DESIGNER.
 - ALL PANEL SIZES ARE BASED ON THE ARCHITECTURAL DRAWINGS, APPROVED SHOP DRAWINGS, AND SLAB EDGE MEASUREMENTS ISSUED.
 - ALL CLADIFY PANELS ARE PORCELAIN FACING WITH ALUMINUM HONEY COMB BACKING.
- NOTE:
- DUE TO THE SIZE OF THE PANELS, THE PRODUCTION MANAGER MAY SUGGEST THICKER ALUMINUM BACKING SYSTEM.
 - DUE TO THE SIZE OF THE PANELS, THE REQUIRED TEMPERATURE FOR INSTALLATION IS +12 °C.
 - ALL HORIZONTAL AND VERTICAL JOINTS ARE 20mm UNLESS NOTED OTHERWISE. MAKE UP ALONG ENTIRE LENGTH TO ACCOUNT FOR DIMENSIONAL ROUNDING OF INDIVIDUAL STONE LENGTHS.
 - SITE CUT STONE TO SUIT CONDITIONS ARE REQUIRED.
 - DO NOT SCALE DRAWING.
 - PANEL SIZE TOLERANCE IS -1-2 INCHES
 - DUE TO WALL ASSEMBLY DEPTH, CLADDING SYSTEM MAY VARY.
 - SYSTEM SIZE TO BE CONFIRMED.
 - PENETRATIONS TO BE SEALED

ABBREVIATIONS:

CL = CLADIFY	E/O = END OF
T/O = TOP OF	C/O = CORNER OF
B/O = BOTTOM OF	TYP = TYPICAL
REF. = REFERENCE/REFER	SIM. = SIMILAR
M/E = MITERED EDGE	F/O = FACE OF

SEAL

REV.	YY-MM-DD	DESCRIPTION
0	2023-08-22	INITIAL SHOP DRAWINGS

ARCHITECT

CLIENT

PROJECT TITLE
CladiCast
 LIGHT WEIGHT PRECAST SOLUTION

SHEET TITLE
 DETAILS

INFORMATION
 DATE: 2023-08-22
 SCALE: AS INDICATED
 DRAWN BY: GC
 MEASURED BY:
 CHECKED BY: AR / AS

DRAWING NO:

PC-009

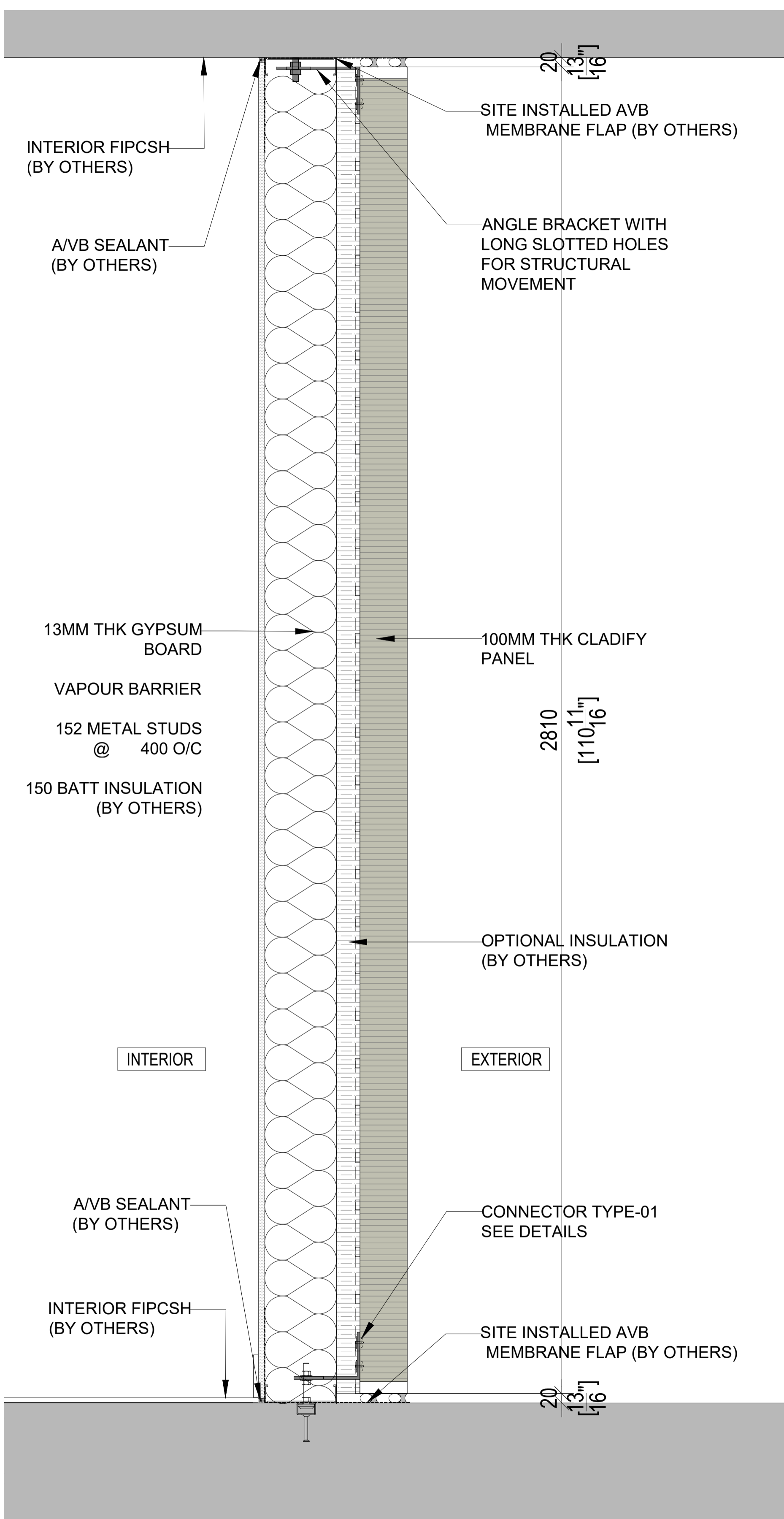

01 PANEL SECTION @ BALCONY
 PC-009 SCALE: 1:10

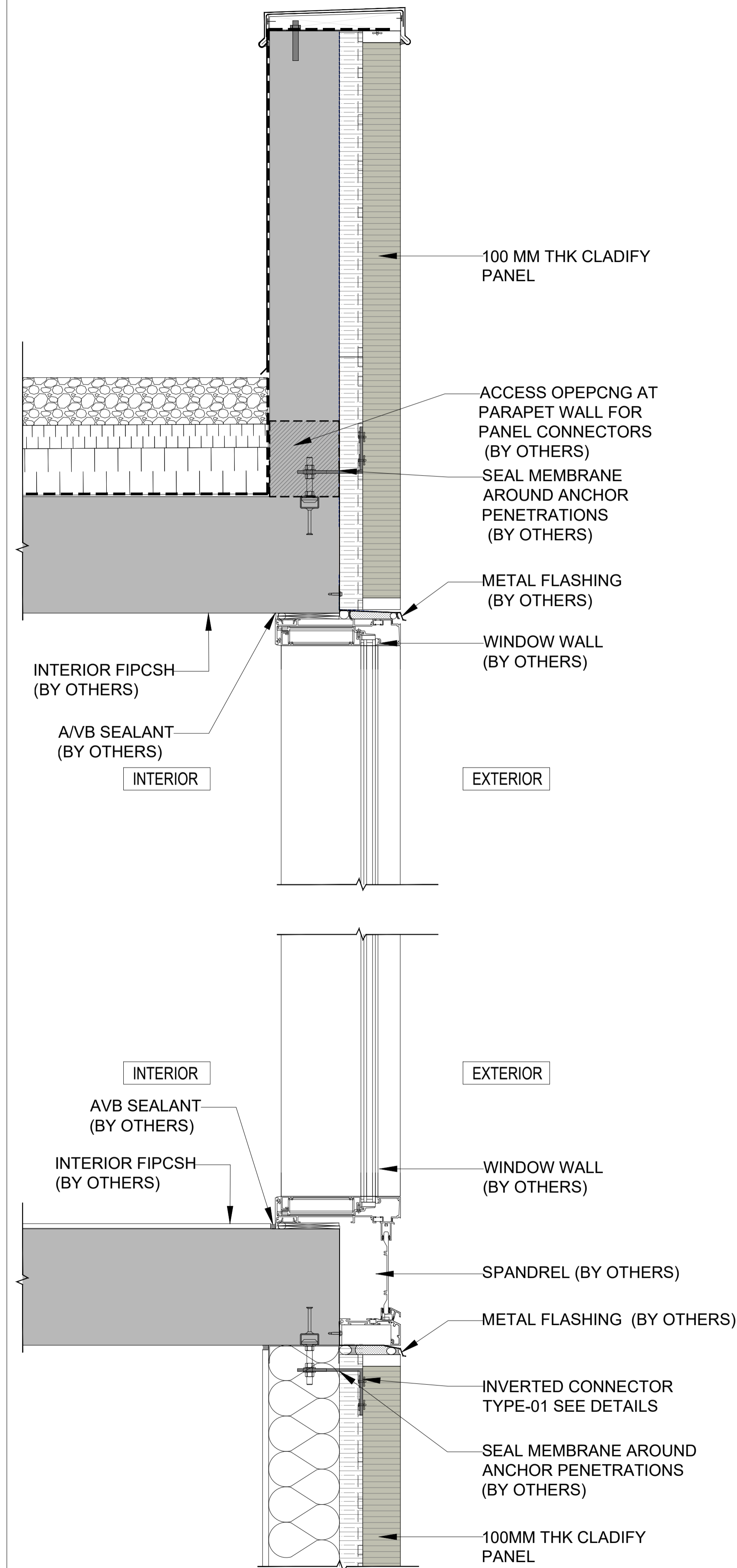

02 WALL SECTION @ WINDOW WALL
 PC-009 SCALE: 1:10

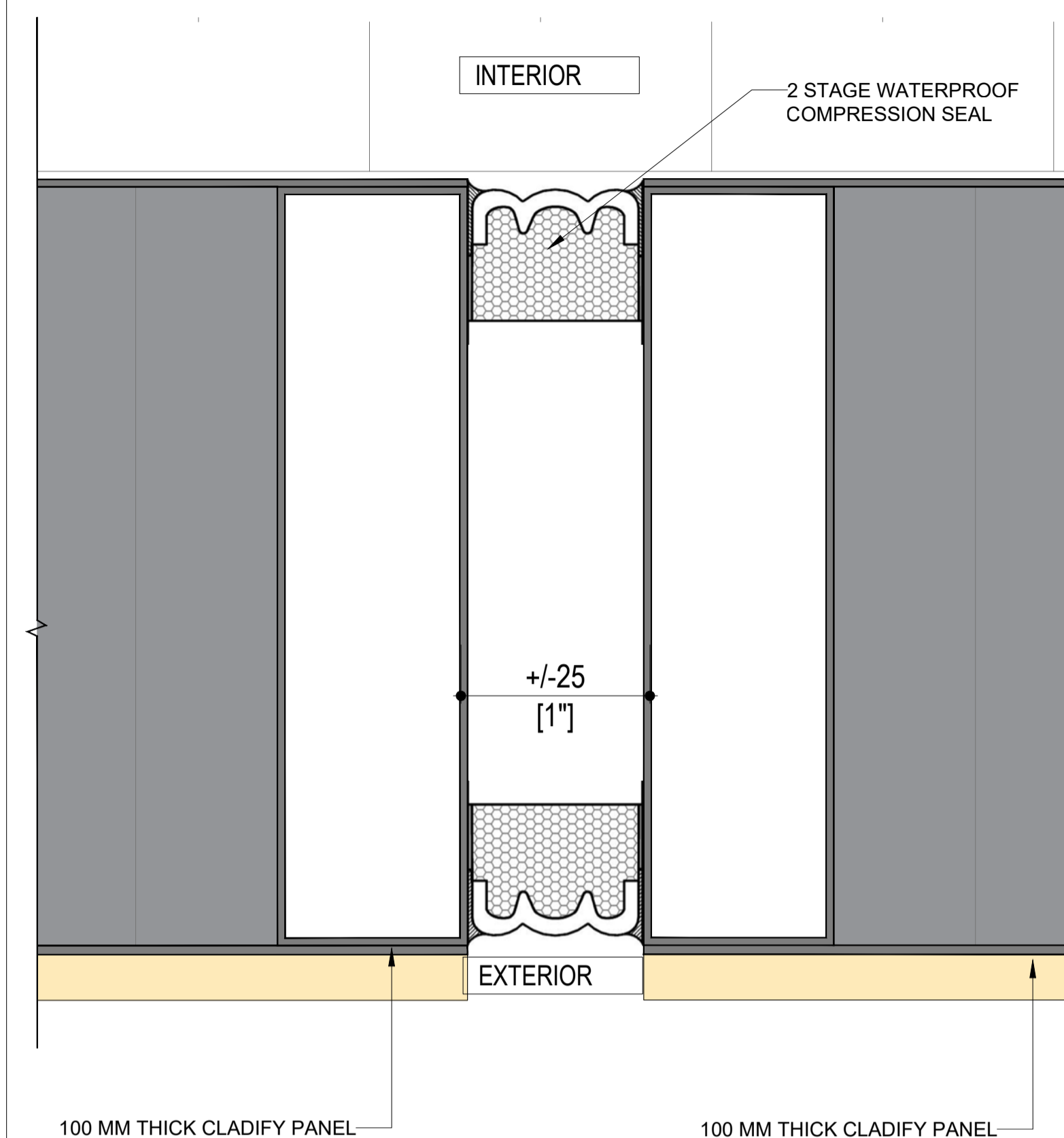

04 PANEL EXPANSION JOINT DETAIL
 PC-009 NDTs

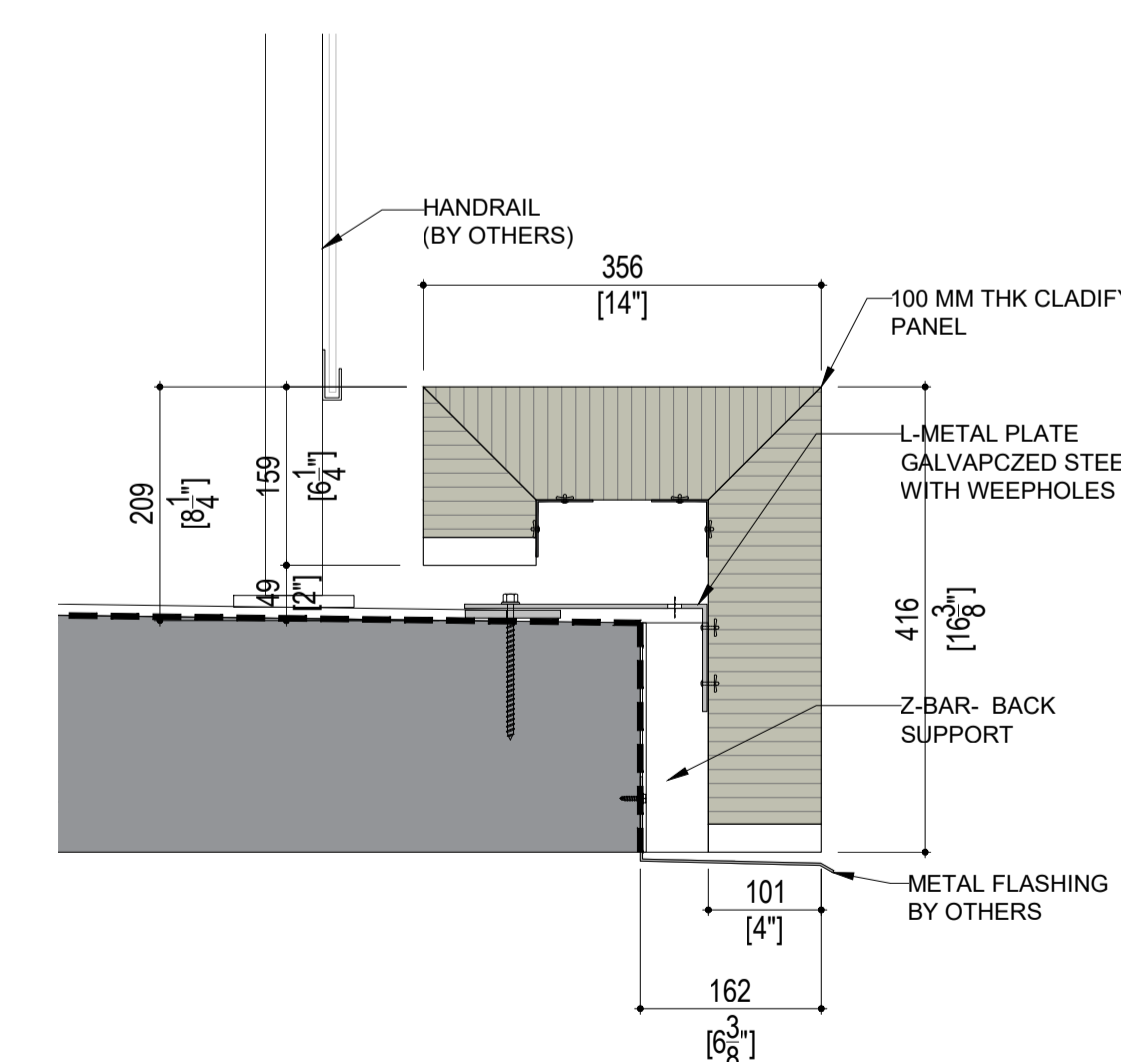

03 PANEL @ SLAB EDGE
 PC-009 SCALE: 1:10

