



MITREX™

BUILDING-INTEGRATED SOLAR TECHNOLOGY

INSTALLATION MANUAL

FRAME SOLAR MODULES

Mxxx-A1F - Mxxx-B1F - Mxxx-yyyy1F

Rev.2

TABLE OF CONTENT

1. SAFETY PRECAUTIONS & HANDLING OF MODULES	03
1.1 Manual Disclaimer	
1.2 Limitation Of Liability	
1.3 General Information	
1.4 General Warning	
2. PRODUCT INFORMATION	04
2.1 Product Certifications	
2.2 Limited Warranty	
2.3 Technical Specifications	
3. ELECTRICAL INSTALLATION	04
3.1 General Information	
3.2 Wiring Requirements	
3.3 Series Connection	
3.4 Parallel Connection	
3.5 Electrical Grounding	
4. MECHANICAL INSTALLATION	06
4.1 General Information	
4.2 Site Considerations	
4.3 Module Mounting	
4.4 Mounting Via Clamps	
5. APPENDIX	08
5.1 Electrical Specifications	
5.2 Mechanical Specifications	
5.3 Temperature Specifications	
5.4 Clamping Position	

1. SAFETY PRECAUTIONS & HANDLING OF MODULES

1.1 MANUAL DISCLAIMER

The information presented in this manual is subject to change by Mitrex without prior notice. Mitrex gives no warranty of any kind whatsoever, either explicitly or implicitly, with respect to the information herein. In the case of any inconsistency between different language versions, the English version shall overcome and take control in all respects.

1.2 LIMITATION OF LIABILITY

Mitrex shall not be held responsible for damages of any kind, including – without limitation – bodily harm, injury or damage to property, in connection with handling PV modules, system installation, or compliance or non-compliance with the instructions set forth in this manual.

1.3 GENERAL INFORMATION

The following instructions relate to the safety and intended use of PV modules. Failure to comply with any instructions below may result in product damage, physical injury and/or death.

This installation manual contains essential information for the electrical and mechanical installation that you must know before installing modules. All information described in this manual are intellectual property and based on technologies and experiences that have been acquired and accumulated throughout years.

The installation of PV modules requires a great degree of skill and should only be performed by a qualified licensed professional, including licensed contractors and licensed electrifications. Please be aware that there is a serious risk of various types of injury occurring during the installation including the risk of electric shock. All modules are equipped with a permanently attached junction box that will accept variety of wiring applications or with a special cable assembly for ease of installation, and they do not require special assembly.

1.4 GENERAL WARNING

- ⚠ All modules must be installed by licensed electricians in accordance with the applicable geographic electrical codes and standards.
- ⚠ Do not connect or disconnect modules when current from the modules or an external source is present.
- ⚠ Always use appropriate Personal Protective Equipment when installing PV modules.
- ⚠ Modules should be stored in a dry and ventilated environment to avoid direct sunlight and moisture.
- ⚠ Always use electrically insulated tools to reduce the risk of electric shock.
- ⚠ The PV module does not contain any serviceable parts. Do not attempt to modify or repair any part of the module.



If modules are stored in an uncontrolled environment, the storage time should be less than 3 months and extra precautions should be taken to prevent connectors from being exposed to moisture or sunlight, like using connector endcaps.

- ⚠ Perform all work in safe and dry conditions.
- ⚠ External or artificially concentrated sunlight shall not be directed onto the PV module.
- ⚠ Do not use or install damaged modules.
- ⚠ Modules must always be handled and installed by two people.
- ⚠ Do not carry the module by its cables.
- ⚠ Do not stand, step, walk and / or jump on modules under any circumstances.
- ⚠ Handle the module in a way that avoids breakage, scratching, bending of the glass and backsheet.
- ⚠ Do not drop or place objects (such as tools) on the modules.
- ⚠ Always handle the modules by the frame.
- ⚠ Do not use sharp instruments on the modules.
- ⚠ Do not lift modules by their wires or junction box, lift them by the frame.
- ⚠ Keep all connectors clean and dry at all times.
- ⚠ Do not place excessive loads on the module or twist the module frame.

- Do not expose the modules and its connectors to any unauthorized chemical substance (e.g. oil, lubricant, pesticide, etc.).
- Do not leave modules unsupported or unsecured.
- Particular care should be taken to avoid module backsheets being damaged by sharp objects, as scratches may directly affect product safety.

2. PRODUCT INFORMATION

2.1 PRODUCT CERTIFICATIONS

Mitrex products meet and/or exceed the requirements set forth by UL 61730, UL 61215, CSA C22.2 NO. 61730, CSA C22.2 NO. 61215, IEC 61730 and IEC 61215 for PV modules. These UL, CSA and IEC are freestanding. To satisfy the listing for this product the modules must be mounted with a rack or standoff structure. The module is considered to be in compliance with UL 61215/61730, CSA 61215/61730 and/or IEC 61215/61730 only when the module is mounted in the manner specified by the mounting instructions contained in this document.

2.2 LIMITED WARRANTY

Mitrex provides a 25-year hardware warranty, and we guarantee that after 25 years, the efficiency of the panel will be no less than 80% of the original energy generation. For more information on the details covered within the warranty and the claim process, scan the QR code below.



2.3 TECHNICAL SPECIFICATIONS

A full list of mechanical and electrical technical specifications for the PV modules can be found in the Appendix section. Electrical test data is according to standard test conditions (IEC 60904-3).

Under normal conditions, a photovoltaic module is likely to experience conditions that produce higher current and/or voltage than reported at

standard test conditions. Accordingly, the values of Isc and Voc marked on the PV module should be multiplied by a factor of 1.25 when determining component voltage ratings, conductor current ratings, and size of controls (e.g. inverter) connected to the PV output.

3. ELECTRICAL INSTALLATION

3.1 GENERAL INFORMATION

 Ensure correct polarity when connecting PV modules.

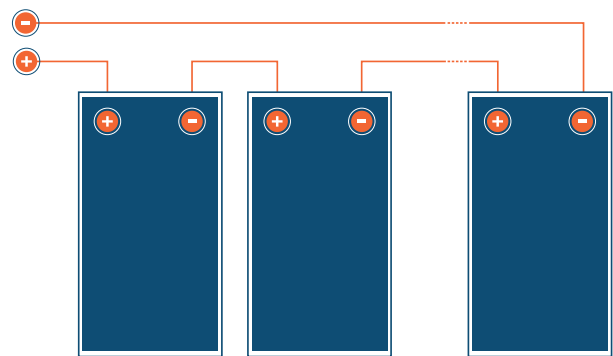



Connectors are not waterproof when unmated. When installing modules, connector should be connected to each other as soon as possible or appropriate measures should be taken to avoid moisture and dust penetrating into the connector.

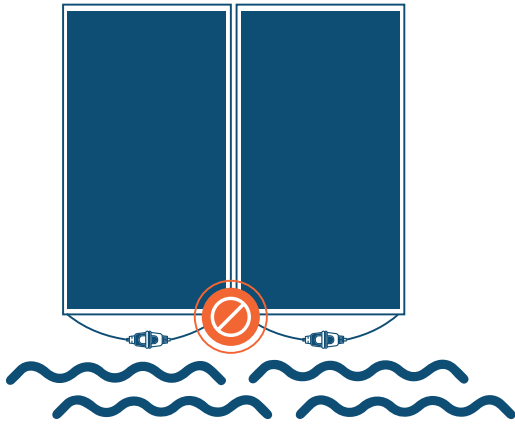

Make sure that all connections are safe and properly mated. An audible click should be heard when mating connectors. The PV connector should not be subjected to stress from the exterior. Connectors should only be used to

connect the circuit. They should never be used to turn the circuit on and off.



 Ensure cabling is adequately protected from direct sunlight, dirt, debris, moisture, and mechanical friction.

- Ensure that plug connections are secured away from any water-accumulating surfaces. Use UV-resistant cable ties to secure cables to the mounting system. Cables should avoid exposure to direct sunlight.

- Only use dedicated solar cable and suitable connectors (wiring should be sheathed in a sunlight-resistant conduit or, if exposed, should be sunlight-resistant itself) that meet local fire, building and electrical regulations. Please ensure that all wiring is in perfect electrical and mechanical condition.

3.2 WIRING REQUIREMENTS

- Mitrex recommends that all wiring be double insulated with a minimum rating of 90°C (194°F).
- All wiring should use a flexible copper conductor.
- Minimum size should be determined by applicable codes.
- Mitrex recommends a minimum size of 10AWG.
- All Mitrex solar modules are connected via MC4 connectors.

3.3 SERIES CONNECTION

- The solar modules may be wired in series to

produce the desired voltage output.

- The current of each module connected in series should be the same.
- The maximum PV system voltage for that circuit shall be calculated as the sum of the rated open-circuit voltage of the series-connected PV modules corrected for the lowest expected ambient temperature.

3.4 PARALLEL CONNECTION

- The solar modules may be combined in parallel to produce the desired current output.
- When modules are combined in parallel, the total current is equal to the sum of currents from each module.
- The voltage of each module connected in parallel should be the same.
- When connecting plural strings of modules in parallel every series string or solar module must be fused prior to combining with other strings.
- Abide with all applicable federal, state, and local codes for additional fusing requirements and limitations on the maximum number of solar modules in parallel.
- Depending on national directives, additional safety factors might be applicable for over current protection.

 A multiplying factor is required for increased output of the PV modules. Under normal conditions, a PV module is likely to experience conditions that produce more current and/or voltage than reported at standard test conditions.

The requirements of the National Electrical Code (NEC) in Article 690 shall be followed to address these increased outputs. In installations not under the requirements of the NEC, the values of I_{sc} and V_{oc} marked on this PV module should be multiplied by a factor of 125% when determining component voltage ratings, conductor ampacities, fuse sizes, and size of controls to the PV output.

3.5 ELECTRICAL GROUNDING

- All work must be conducted in conformance with all Federal, State, and local codes and

standards.

- Do not drill any extra ground holes for convenience this will void the modules warranty.
- Grounding connections should be performed by a qualified electrician for the safety and maintenance of the system in accordance with all national, state and local electrical codes and regulations and standards.
- Connect module frames together using adequate grounding cables: Mitrex recommends using 4-14 mm² (AWG 12-6) copper wire.
- All bolts, nuts, flat washers, lock washers and other relevant hardware should be made of stainless steel, unless otherwise specified.



In most of frames, holes provided for this purpose are identified with a grounding symbol (IEC 61730-1). Otherwise the location is in the middle of long frame on both side of the module. All conductive connection junctions must be firmly fixed.

Where common grounding hardware (nut, bolts, washers) is used to attach a listed grounding device, the attachment must be made in conformance with the grounding device manufacturer's instructions.

- A module with exposed conductive parts is considered to be in compliance with UL only when is electrically grounded in accordance with the instructions presented below and the requirements of the National Electrical Code.

4. MECHANICAL INSTALLATION

4.1 GENERAL INFORMATION

The module is considered to be in compliance with applicable standards only when the module is either mounted in the manner specified by the mounting instructions, or when the mounting means has been evaluated with this PV module to UL 2703. A module with exposed conductive parts is considered to be in compliance with applicable standards only when it is either electrically grounded in accordance with the manufacturer's instructions and the requirements of the National

Electrical Code, ANSI/NFPA 70 (2014-2017), or when the bonding means has been evaluated with this PV module to UL 2703.

4.2 SITE CONSIDERATIONS

Mitrex Solar Modules should be mounted in a location that meets the following requirements.

- The module is intended for use in general open-air climates, as defined in IEC 60721-2-1 Classification of environmental conditions Part-2-1: Environmental conditions appearing in nature - Temperature and humidity.
- Note the operating temperature listed in the Appendix.
- Please consult the Mitrex technical support department for more information on the use of modules in special climates, such as an altitude greater than 2000m.
- Exposing modules to salt (i.e. marine environments) or sulfur (i.e. sulfur sources, volcanoes) incurs the risk of module corrosion. Special considerations should be made for installations with increased salt content in the air.
- Do not operate solar modules near highly flammable substances.
- Do not expose modules and their connectors to any unauthorized chemical substances (e.g. oil, lubricant, pesticide, etc.), as modules may incur damages.
- Modules should be installed as to minimize shading.
- Do not install modules in an enclosed space.
- Failure to comply with these instructions will void Mitrex limited warranty.

4.3 MODULE MOUNTING

- The mounting design must be certified by a registered professional engineer. The mounting design and procedures must comply with all applicable local codes and requirements from all relevant authorities.
- PV modules should be oriented to maximize sunlight exposure.
- A slope less than 5" / ft is required to maintain a fire class rating.
- The fire rating of this module is valid only when mounted as specified in the mechanical mounting instructions.

- When installed on a roof, solar modules must be mounted over a fire-resistant roof covering rated for the application. The fire resistance of the solar module is class C after ANSI/UL790 Edition 2004.

- The PV module is considered to be in compliance with UL61730 only when the module is mounted in the manner specified by the mounting instructions below.

4.4 MOUNTING VIA CLAMPS

- Ensure the mounting clamps are compatible with the racking system (mounting frame) being used.
- Clamp material should be anodized aluminum alloy or stainless steel.
- The module may be fastened to a support by using clamps on a minimum of four points on two opposite sides.
- Clamps should be positioned according to the authorized position ranges as defined in the Appendix.
- Clamps should be positioned symmetrically.

- 80 mm (3.15 in) when $2400 \text{ Pa} < \text{uplift load} \leq 54000 \text{ Pa}$ is required.
- 40 mm (1.57 in) when uplift load $\leq 2400 \text{ Pa}$ is required.

- Clamps are not in contact or cast shadows on the front glass.
- Clamps do not damage, deform, or bend the module frame.
- Clamps that satisfy the structural requirements of the installation site.
- Long-term stable clamps that securely affix the module to the mounting frame.

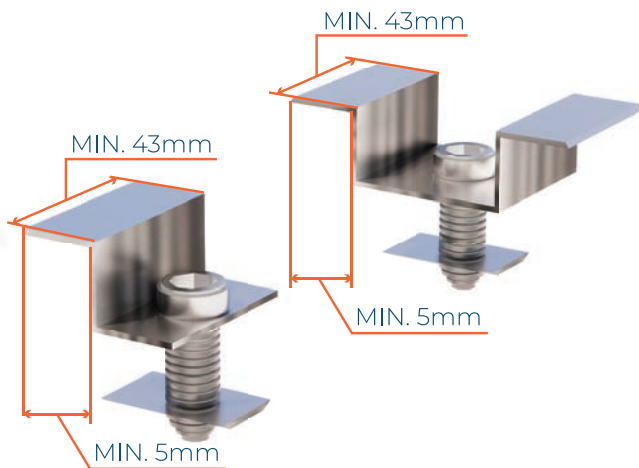

CLAMP SPECS:

- Clamp width: $\geq 43 \text{ mm}$ (1.69in).
- Clamp height compliant with a 40mm (1.57in) frame height.
- Clamp depth: 5 – 12mm (0.2in – 0.47in).
- Clamp thickness: $\geq 3 \text{ mm}$ (0.12in).
- Overlap in length by at least;

5. APPENDIX

5.1 ELECTRICAL SPECIFICATIONS

SOLAR PANEL - Mxxx-A1F - Mxxx-B1F

Model Name	Pmax [W]	I _{max} [A]	V _{max} [V]	I _{sc} [A]	V _{oc} [V]	MSV [V]	Fuse Rating
M390-A1F	390	9.31	41.9	9.97	48.2	1000	20
M395-B1F	395	9.38	42.1	9.81	48.3	1000	20

SOLAR ROOF - Mxxx-RF041F

Model Name	Pmax [W]	I _{max} [A]	V _{max} [V]	I _{sc} [A]	V _{oc} [V]	MSV [V]	Fuse Rating
M345-RF041F	345	8.41	41.0	8.94	48.9	1000	20
M330-RF041F	330	8.09	40.8	8.55	48.7	1000	20
M320-RF041F	320	7.86	40.7	8.29	48.6	1000	20
M310-RF041F	310	7.64	40.6	8.03	48.5	1000	20

Electrical characteristics have tolerance of +/- 5% under STC conditions.

5.2 MECHANICAL SPECIFICATIONS

SPECIFICATIONS	PV MODULE
Cell Type	Mono-crystalline
Cell Arrangement	72 [12x6]
Dimensions	2036x996x40mm
Front Cover	3.2 mm tempered glass
Frame	Anodized aluminum alloy frame
Weight	22kg
J-Box Protection Class	≥ IP67
Cable	4mm ² , 12 AWG (UL)
Connector Protection Class	IP68
Fire Protection Class	Type II

C: Correction factor
T (°C): Ambient temperature

α (%/°C): Temperature coefficient of the selected module.

Electrical sizing and design must be performed by a competent engineer.

5.4 CLAMPING POSITION

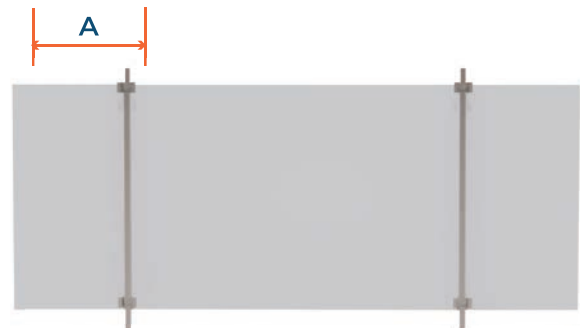

A = (250 – 450) mm
Uplift Load ≤ 5400 Pa
Downforce Load ≤ 5400 Pa

5.3 TEMPERATURE SPECIFICATIONS

TEMPERATURE COEFFICIENT	ALL ABOVE MODULES
αV_{oc}	-0.27 %/°C
αI_{sc}	+0.036 %/°C
αP_{max}	-0.36 %/°C

A more accurate correction factor can be calculated using the equation below:

$$C = 1 - \alpha \times (25 - T)$$

Clamp configuration CL1 – 4 point installation, rails perpendicular to long edge of PV module.

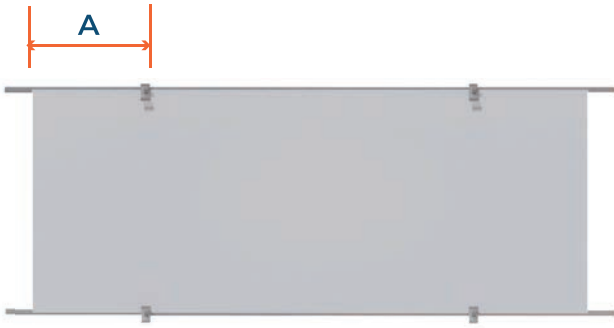

A = (250 – 450) mm
Uplift Load \leq 5400 Pa
Downforce Load \leq 5400 Pa

Clamp configuration CL2 – 4 point installation,
mounting rails parallel to long edge of PV module.



MITREX™

INTEGRATED SOLAR TECHNOLOGY

Learn More:

 mitrex.com

 info@mitrex.com

 +1-855-254-0214 (Toll Free)

Headquarters:

 41 Racine Rd., Toronto,
ON M9W 2Z4, Canada

 +1 (416) 497 7120

USA:

 10880 Wilshire Blvd Suite 1101,
Los Angeles, CA 90024, USA

 +1 (323) 301 7978

 1 Rockefeller Plaza Fl 11,
New York, NY 10020, USA

 +1 (646) 583 4486