

BIPV - DESIGN WITH SOLAR CELLS

DIFFERENT SOLAR CELLS
LAYOUTS

GLASS TYPES

LAMINATED SOLAR GLASS

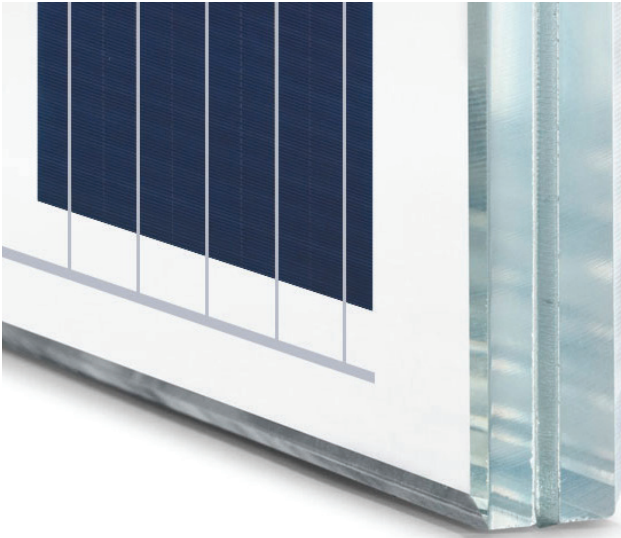

Laminated glass raises the bar for contemporary building and is a symbol of refinement and safety. This novel material redefines architectural possibilities with its unmatched strength, impact resistance, and smooth, exquisite finish. It is made of layers linked together. In today's architectural world, laminated glass is the cornerstone of current architecture, seamlessly fusing safety and style. Its benefits range from improving structural integrity to offering soundproofing and security.

These Laminated Glass layers can exhibit various configurations such as the following:

LAMINATED SOLAR GLASS LAYERS		
	IMPERIAL	METRIC
a./e. Low Iron Glass	0.11in (Opaque only), 0.15in, & 0.23in	3mm (Opaque only), 4mm, & 6mm
b./d./x. Encapsulant	Ethylene Vinyl Acetate: Good radiation transmission and low degradability to sunlight as an encapsulating agent or other interlayer specified.	
c. Solar Cells	Mono-crystalline (6.25in X 6.25in)	Mono-crystalline (158.75mm X 158.75mm)
z. Backsheet (Optional)	High durability, UV resistant, PV backsheet	

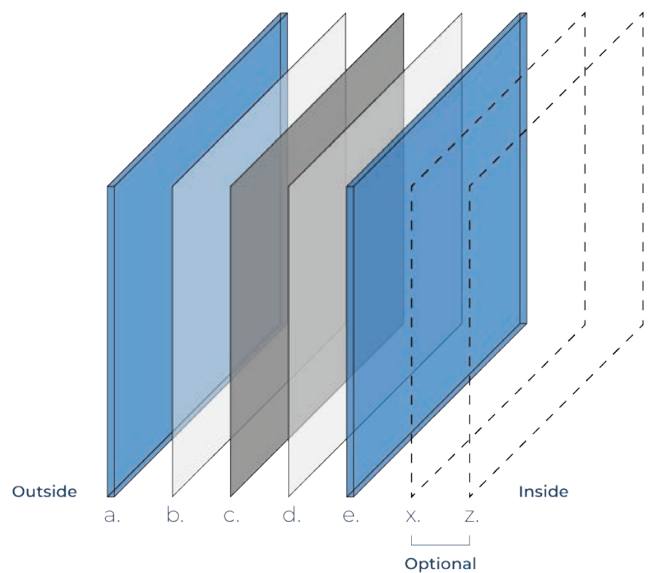

GLASS TYPES

DOUBLE LAYER INSULATED GLASS UNIT (IGU)

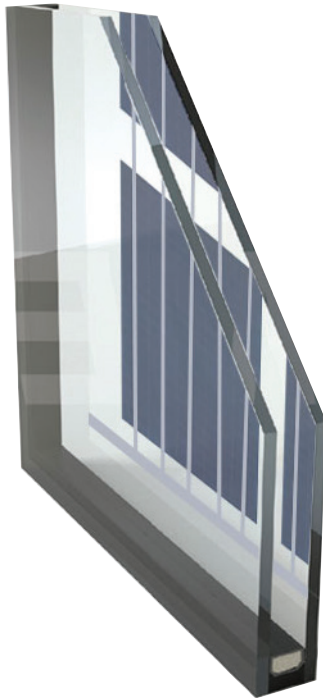

As architectural solutions progress, Insulated Glass Units (IGUs) become a revolutionary invention that redefines the purpose of windows and facades. These state-of-the-art units, made of several glass panes divided by an insulating gas-filled gap, transform buildings with their increased comfort, noise reduction, and greater thermal efficiency. IGUs are a crucial component of sustainable and cozy living spaces since they improve energy efficiency while also adding a contemporary aesthetic touch.

This Insulated Glass Units features a Laminated Solar Glass as a first layer plus a spacer and a second Laminated Solar Glass layer. These layers can exhibit various configurations, such as the following:

DOUBLE LAYER INSULATED GLASS UNIT (IGU)		
	IMPERIAL	METRIC
a./e./g. Low Iron Glass	0.11in (Opaque only), 0.15in, & 0.23in	3mm (Opaque only), 4mm, & 6mm
b./d./x. Encapsulant	Ethylene Vinyl Acetate: Good radiation transmission and low degradability to sunlight as an encapsulating agent or other interlayer specified.	
c. Solar Cells	Mono-crystalline (6.25in X 6.25in)	Mono-crystalline (158.75mm X 158.75mm)
z. Backsheet (Optional)	High durability, UV resistant, PV backsheet	
f. Spacer	0.47in, (0.23in to 0.98in)	12mm, (6mm to 25mm)

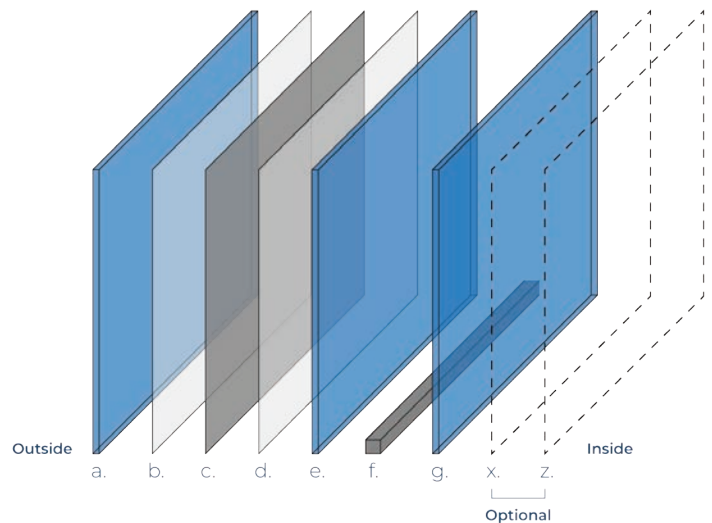

GLASS TYPES

TRIPLE LAYER INSULATED GLASS UNIT (IGU)



This innovative development raises the bar for comfort and energy efficiency to never-before-seen heights. This technique, which consists of three layers of glass divided by insulating voids, raises the bar for environmental sustainability, soundproofing, and thermal insulation. For the most demanding architectural designs and ecologically sensitive settings, the triple-layer IGU is more than just a window—it's a testament to excellent performance, providing enhanced comfort, noise reduction, and exceptional energy efficiency.

This Insulated Glass Units features a Laminated Solar Glass as a first layer, a spacer, a second Laminated Solar Glass layer and a third laminated glass layer. These layers can exhibit various configurations, such as the following:

TRIPLE LAYER INSULATED GLASS UNIT (IGU)		
	IMPERIAL	METRIC
a./e./g./i. Low Iron Glass	0.11in (Opaque only), 0.15in, & 0.23in	3mm (Opaque only), 4mm, & 6mm
b./d./x. Encapsulant	Ethylene Vinyl Acetate: Good radiation transmission and low degradability to sunlight as an encapsulating agent or other interlayer specified.	
c. Solar Cells	Mono-crystalline (6.25in X 6.25in)	Mono-crystalline (158.75mm X 158.75mm)
z. Backsheet (Optional)	High durability, UV resistant, PV backsheet	
f./h. Spacer	0.47in, (0.23in to 0.98in)	12mm, (6mm to 25mm)

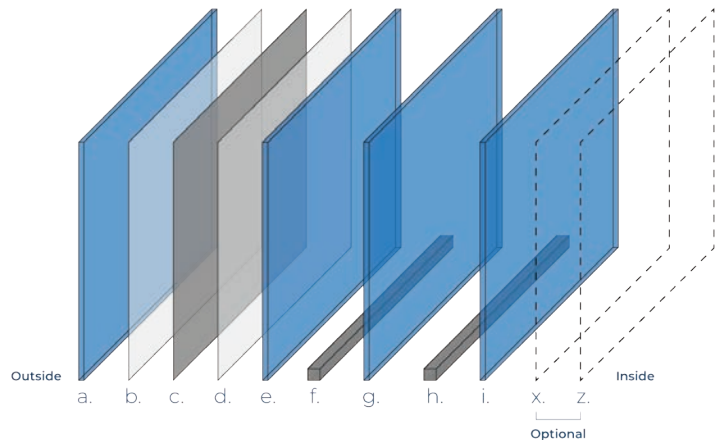

MITREX SOLAR GLASS

STANDARD AND CUSTOM SIZES

RECTANGULAR SHAPE

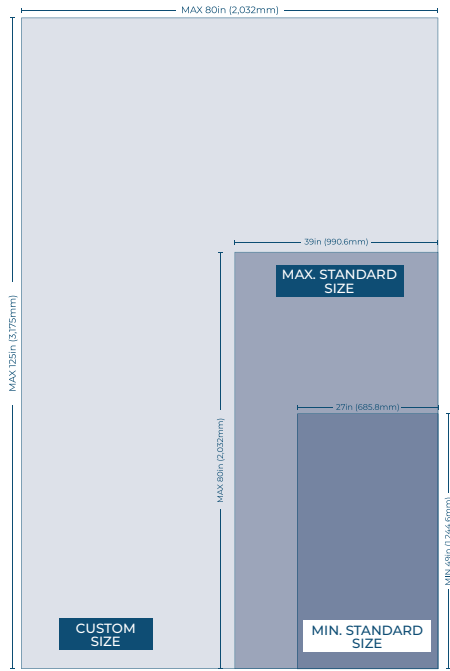

SQUARE SHAPE

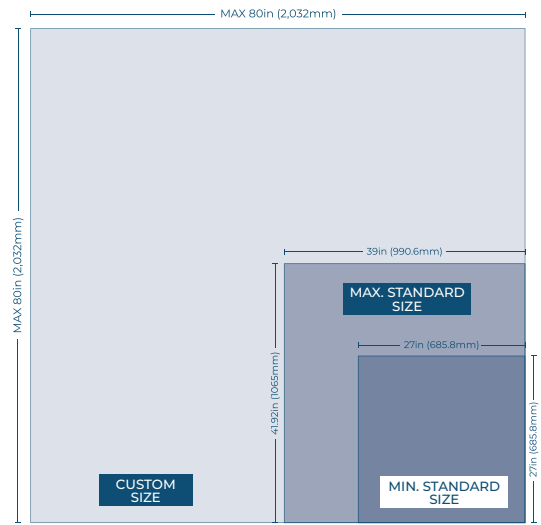

CIRCULAR SHAPE

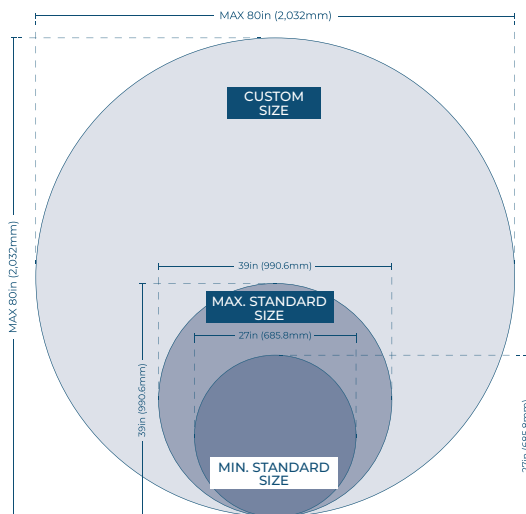

EQUILATERAL TRIANGLE SHAPE

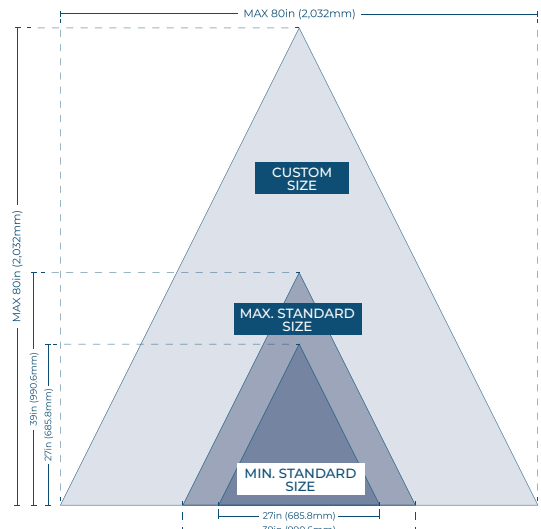

MITREX SOLAR GLASS

STANDARD AND CUSTOM SIZES

ISOSCELES TRIANGLE SHAPE

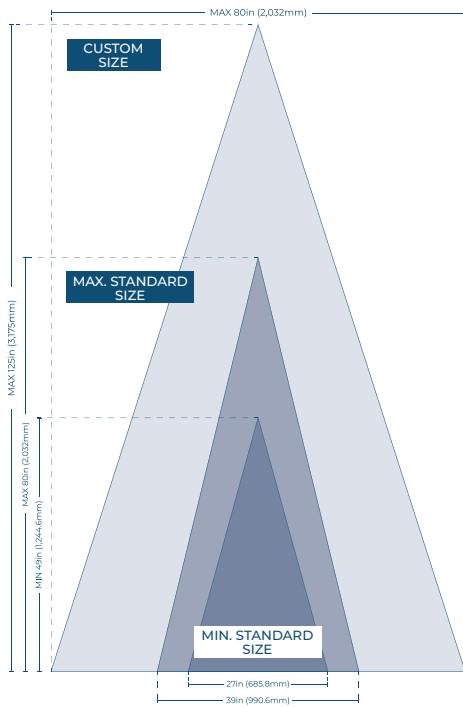

HEXAGONAL SHAPE

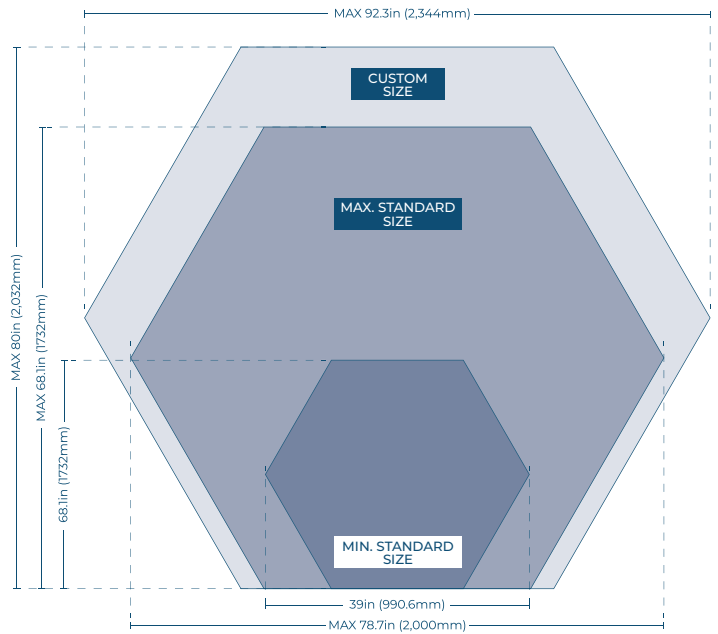

PARALLELOGRAM SHAPE

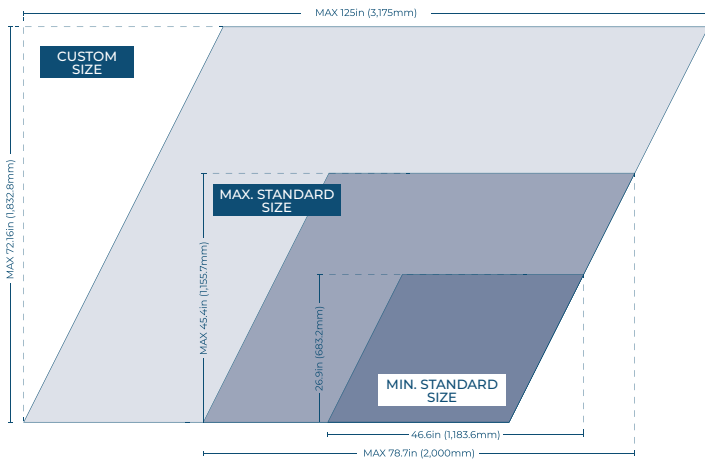

GLASS SHAPES

RECTANGULAR

FLAT STANDARD SIZE

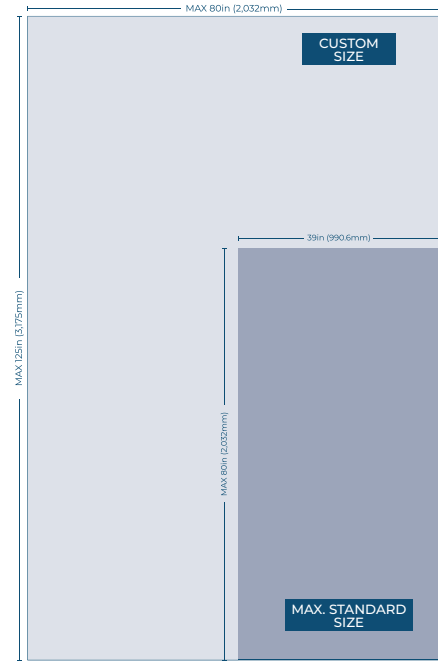
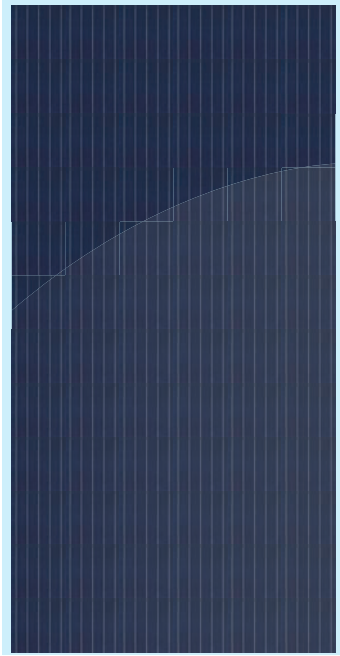

Mitrex standard flat glass panels serve as versatile canvases for integrating various solar cell arrangements, providing a spectrum of options for harnessing solar energy.

CURVED STANDARD SIZE

Mitrex standard curved glass panel, set at a subtle 20-degree angle, offers a sleek and contemporary aesthetic while also providing a unique platform for solar cell arrangements. Different solar cell configurations can be strategically placed across the glass surface, maximizing sunlight absorption throughout the day.

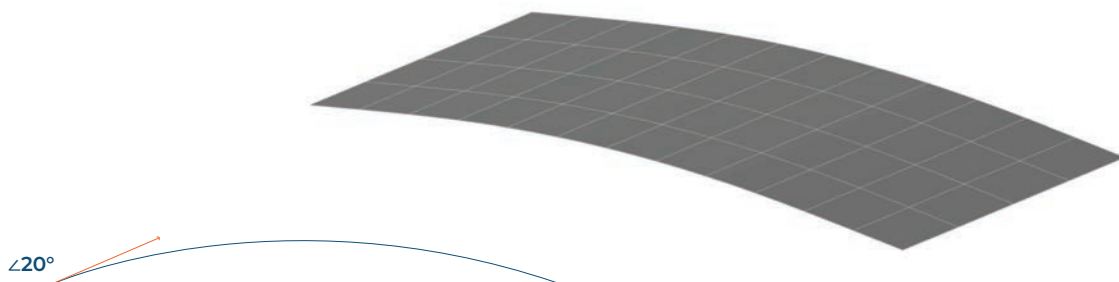

GLASS SHAPES

SQUARE

FLAT STANDARD SIZE

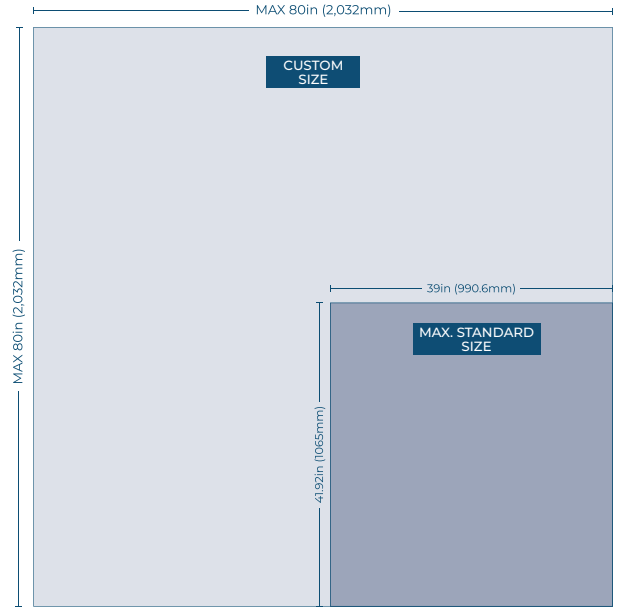
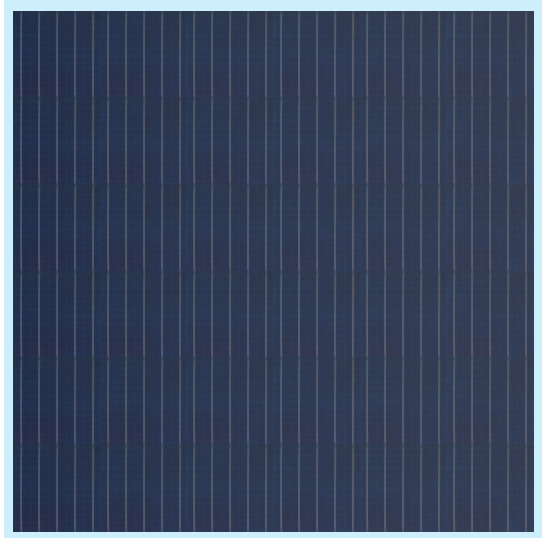

Mitrex's square-shaped flat glass panels offer a flexible platform for incorporating different configurations of solar cells, presenting a wide range of possibilities for capturing solar energy.

CURVED STANDARD SIZE

Mitrex's square-shaped curved glass panels, angled at 20 degrees, offer a sleek design and a unique platform for placing solar cells strategically, maximizing sunlight absorption.

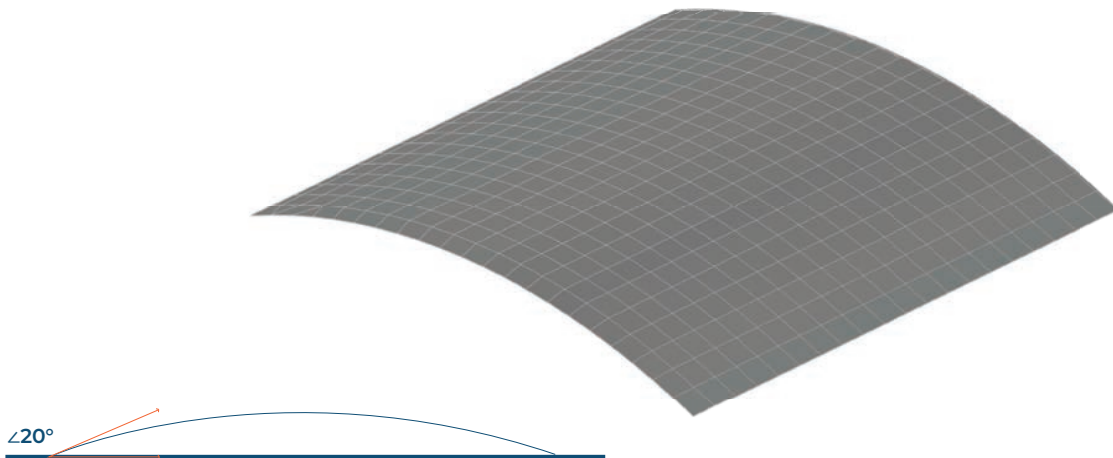

GLASS SHAPES

CIRCULAR

FLAT STANDARD SIZE

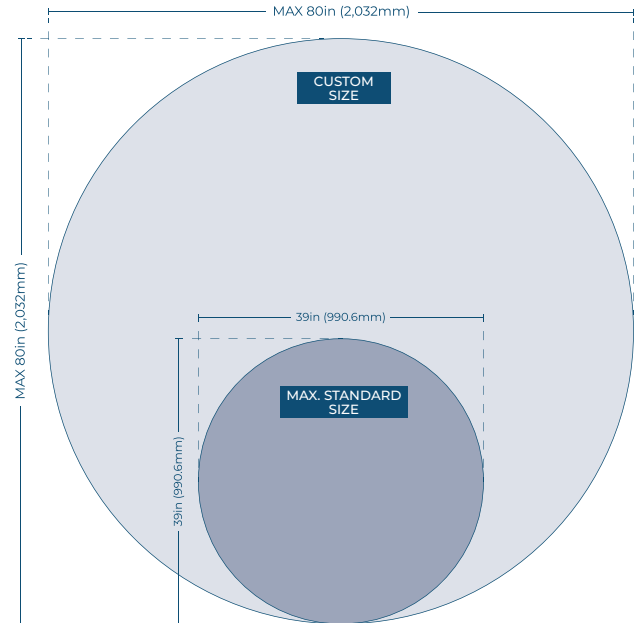
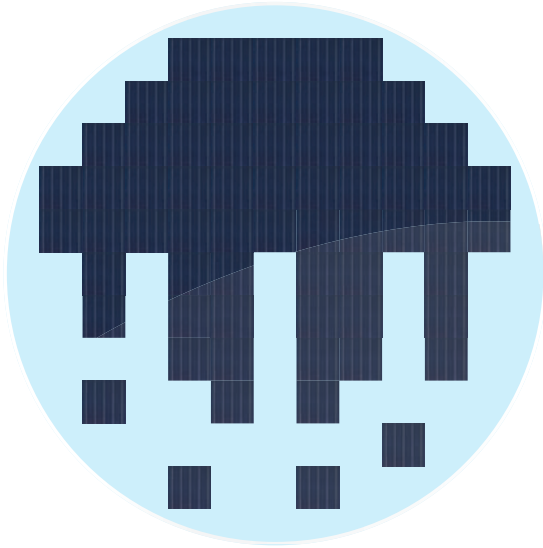

Mitrex's circular-shaped flat glass panels provide versatility for integrating various arrangements of solar cells, offering numerous opportunities to capture solar energy.

CURVED STANDARD SIZE

Mitrex circular-shaped curved glass panel, set at a subtle 20-degree angle, offers a sleek and contemporary aesthetic while also providing a unique platform for solar cell arrangements. Different solar cell configurations can be strategically placed across the glass surface, maximizing sunlight absorption throughout the day.

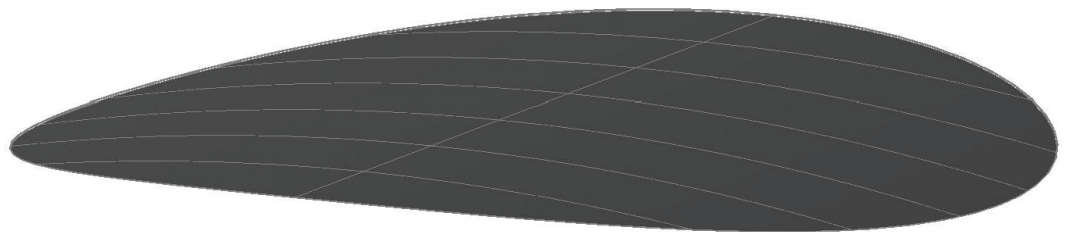

GLASS SHAPES

ISOSCELES TRIANGLE

FLAT STANDARD SIZE

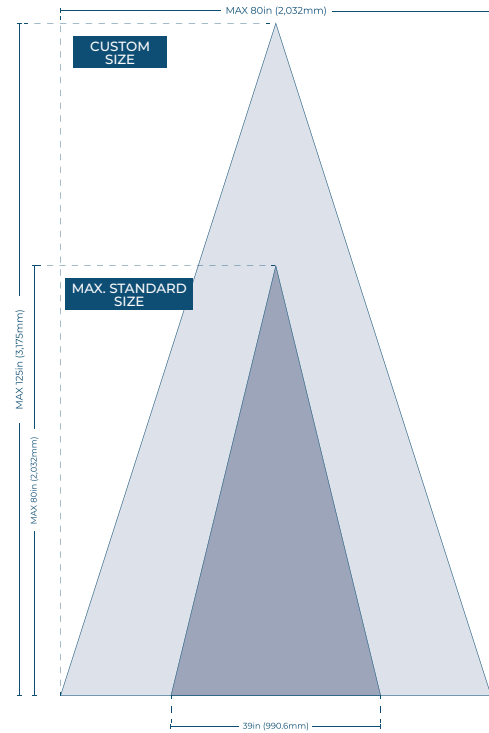
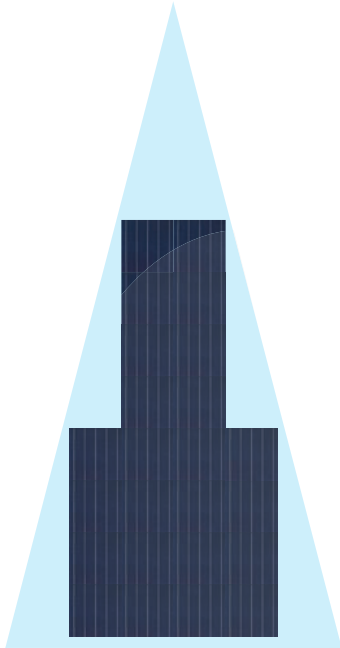

Mitrex Isosceles flat glass panels offer distinct design possibilities for integrating diverse solar cell arrangements, catering to both aesthetic appeal and power optimization. The isosceles panels, with their asymmetrical shape, enable creative placements of solar cells, allowing for unique and unconventional configurations that can enhance the visual appeal of structures.

CURVED STANDARD SIZE

Mitrex's triangular-shaped curved glass panels, angled at 20 degrees, offer a sleek design and a unique platform for placing solar cells strategically, maximizing sunlight absorption.

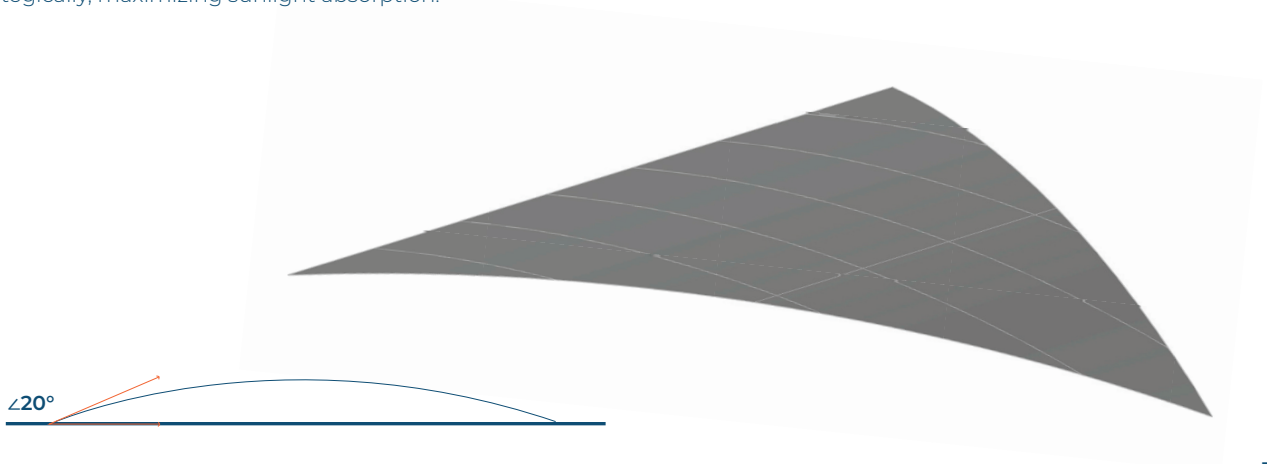

GLASS SHAPES

EQUILATERAL TRIANGLE

FLAT STANDARD SIZE

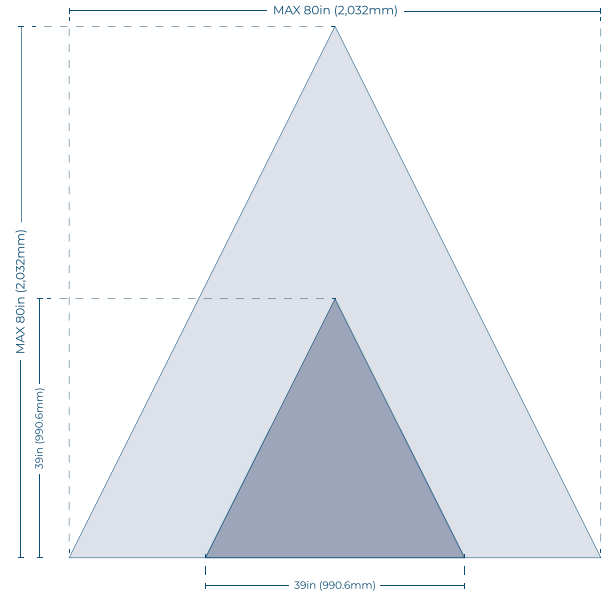
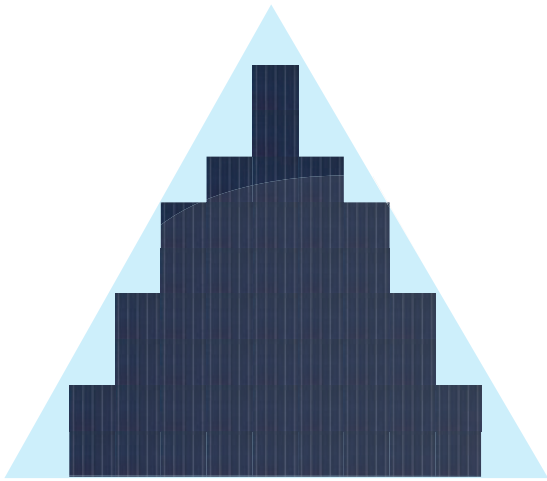

Mitrex equilateral flat glass panels offer distinct design possibilities for integrating diverse solar cell arrangements, catering to both aesthetic appeal and power optimization. Equilateral panels, on the other hand, provide a symmetrical and uniform canvas for arranging solar cells in standard or tailored patterns, maximizing power generation while maintaining a clean and consistent design.

CURVED STANDARD SIZE

Mitrex's triangular-shaped curved glass panels, angled at 20 degrees, offer a sleek design and a unique platform for placing solar cells strategically, maximizing sunlight absorption.

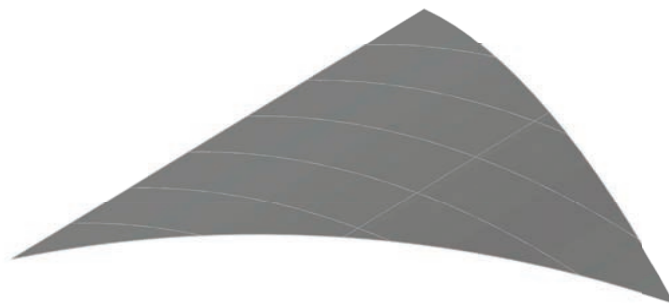

GLASS SHAPES

HEXAGONAL

FLAT STANDARD SIZE

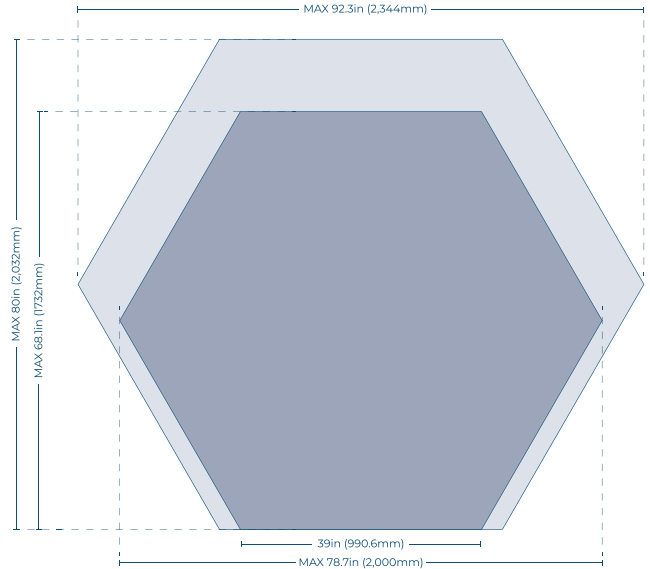
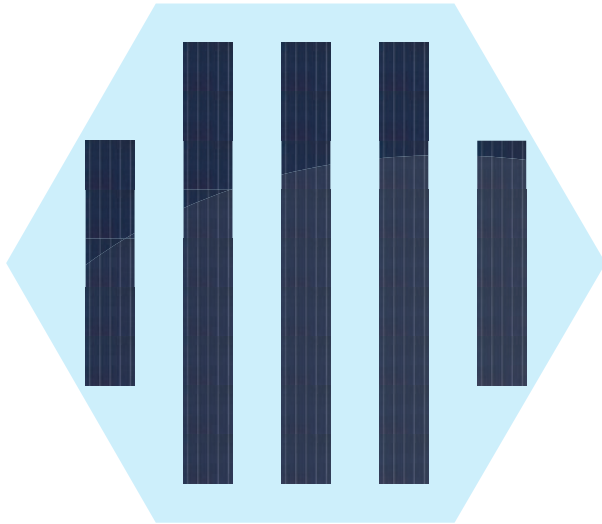

Mitrex hexagonal glass shapes represent a dynamic canvas for integrating diverse solar cell arrangements, offering an innovative blend of design flexibility and enhanced power generation. The unique geometry of hexagonal panels allows for creative configurations of solar cells, adapting seamlessly to unconventional patterns that augment both the aesthetics and functionality of installations.

CURVED STANDARD SIZE

Mitrex's hexagonal-shaped curved glass panels, angled at 20 degrees, offer a sleek design and a unique platform for placing solar cells strategically, maximizing sunlight absorption.

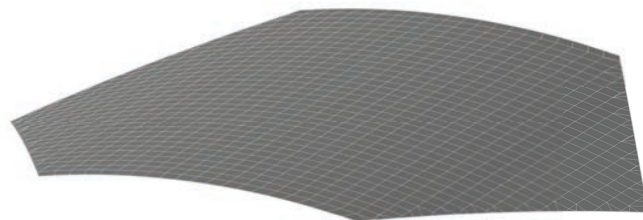

GLASS SHAPES

PARALLELOGRAM

FLAT STANDARD SIZE

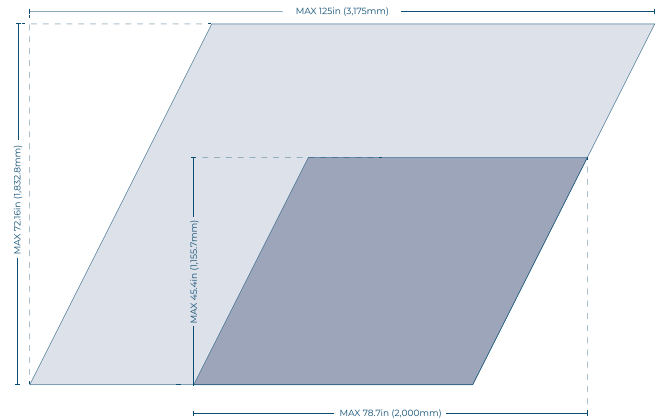
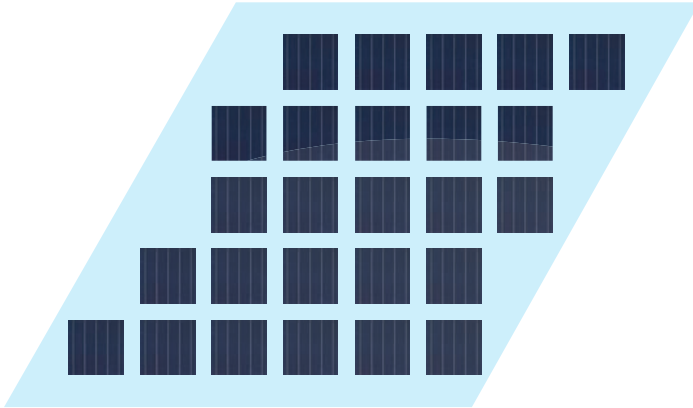

Mitrex parallelogram-shaped glass panels introduce a new dimension of design versatility, offering a canvas for diverse solar cell arrangements that amplify both the aesthetic allure and energy efficiency of structures. The unique angles and lines of parallelogram panels provide an unconventional yet adaptable space for creative configurations of solar cells. This shape allows for tailored arrangements, maximizing exposure to sunlight and optimizing energy generation.

CURVED STANDARD SIZE

Mitrex's parallelogram-shaped curved glass panels, angled at 20 degrees, offer a sleek design and a unique platform for placing solar cells strategically, maximizing sunlight absorption.

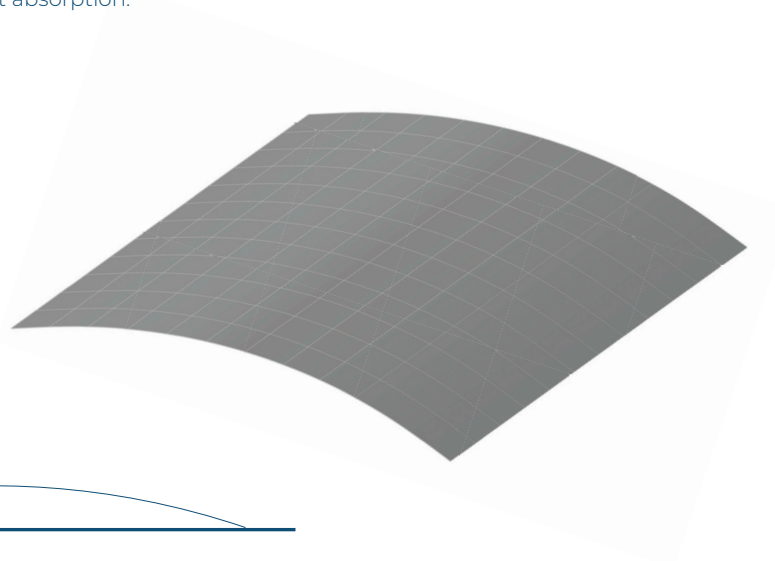

CELL ARRANGEMENTS

RECTANGULAR SHAPE

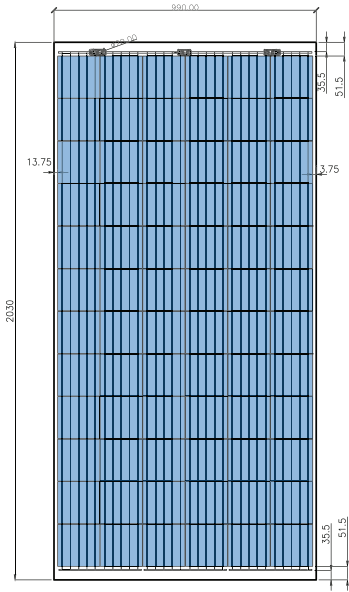

A1

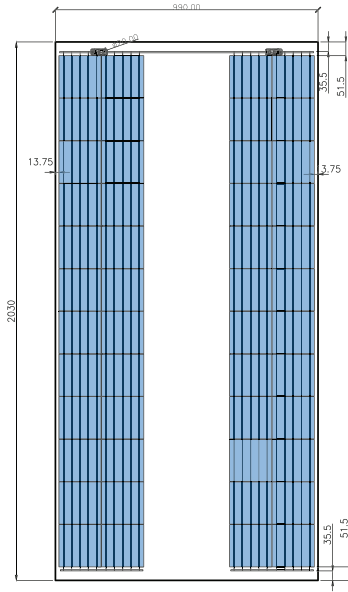

A2

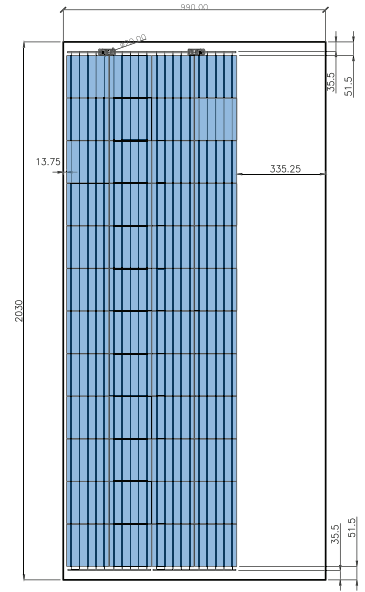

A3

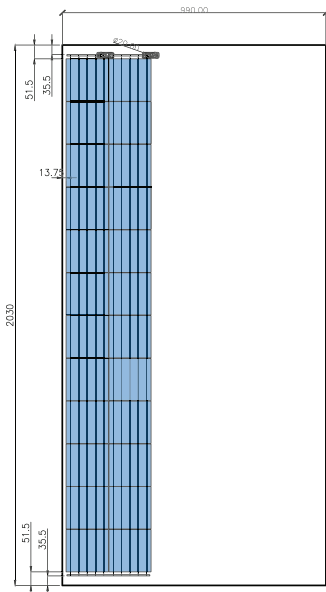

A4

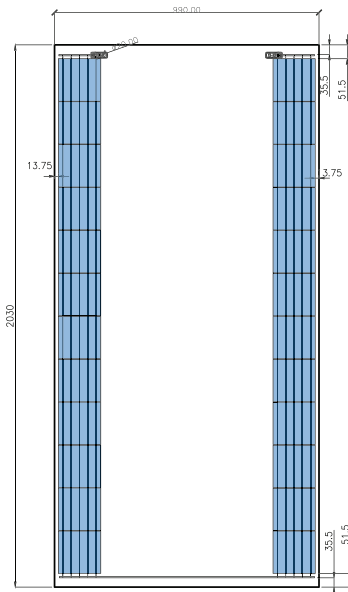

A5

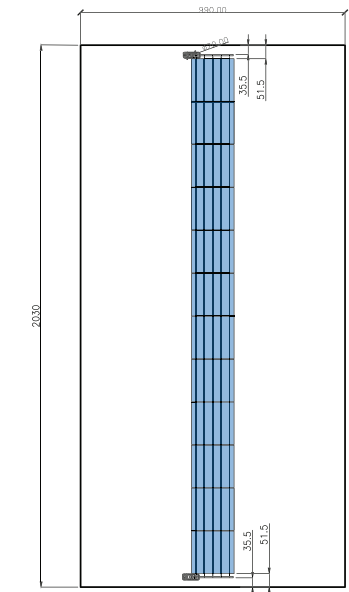

A6

CELL ARRANGEMENTS

RECTANGULAR SHAPE

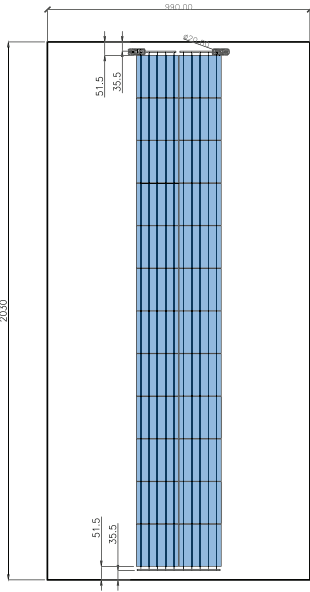

A7

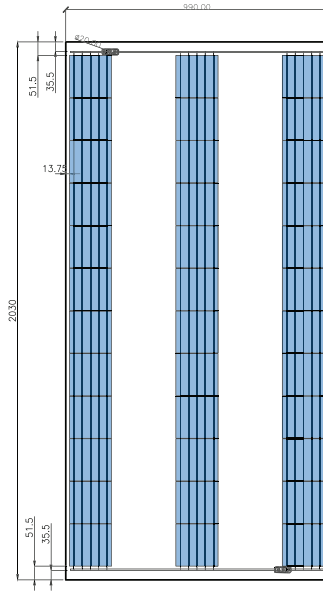

A8

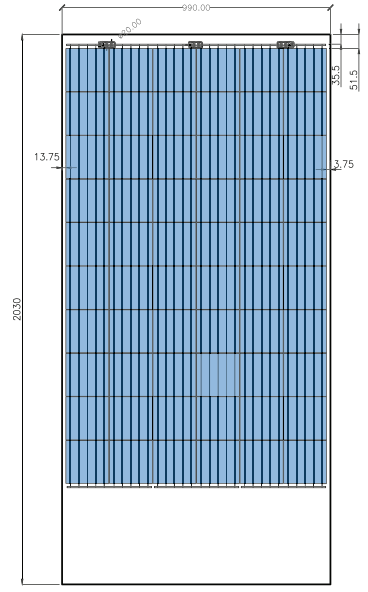

A21

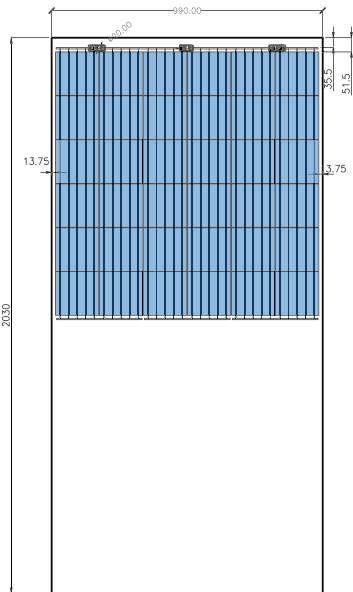

A22

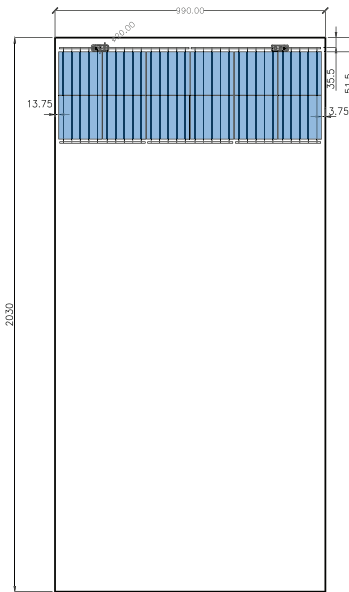

A23

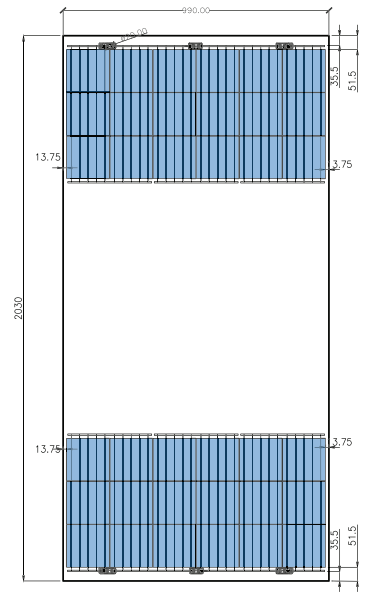

A24

CELL ARRANGEMENTS

RECTANGULAR SHAPE

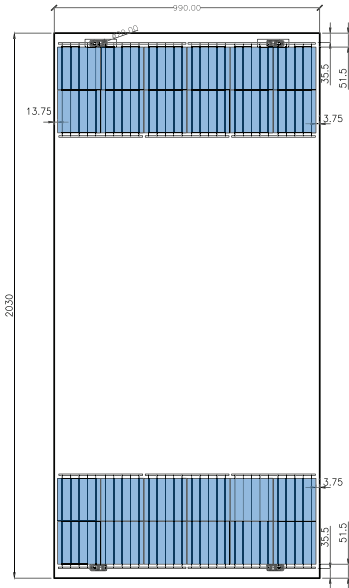

A25

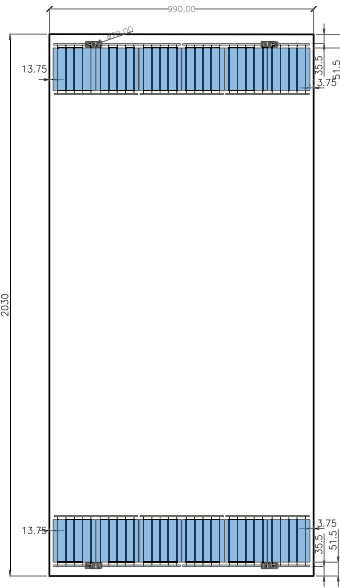

A26

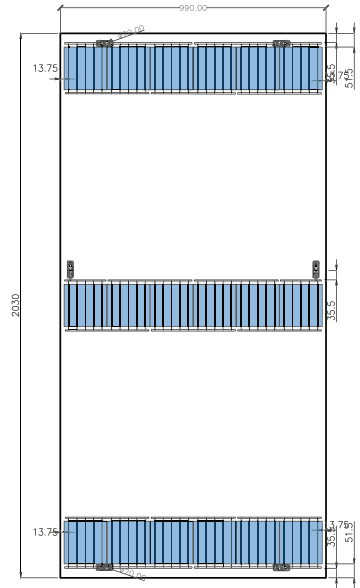

A27

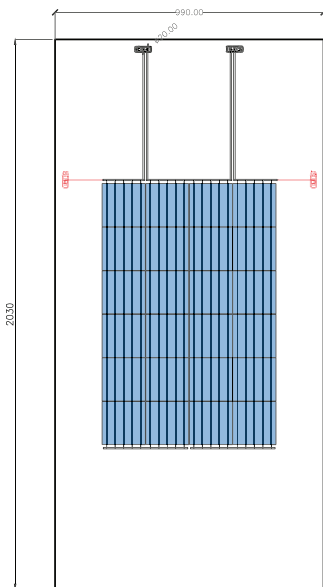

A31

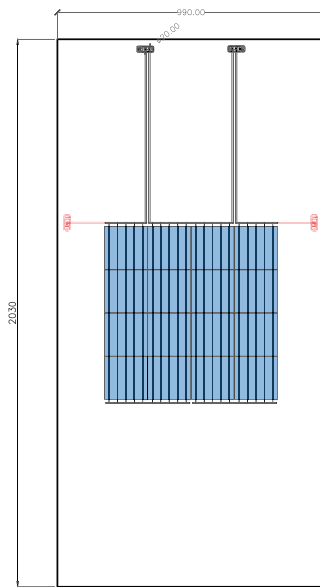

A32

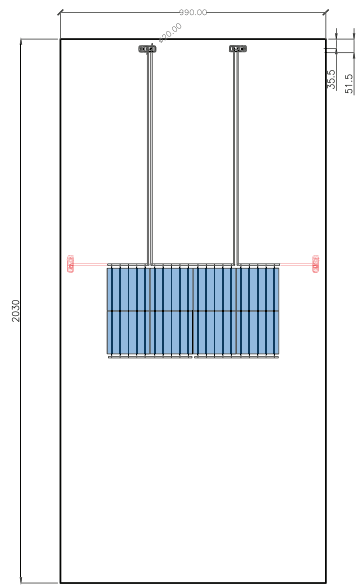

A33

CELL ARRANGEMENTS

RECTANGULAR SHAPE

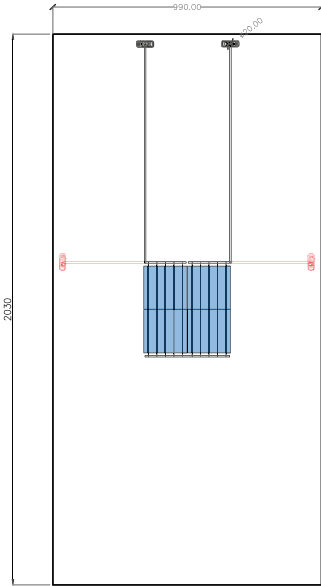

A34

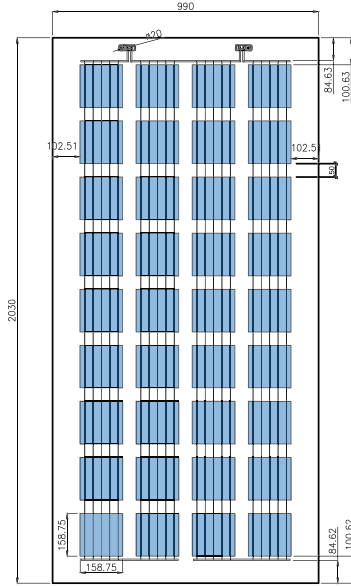

A111

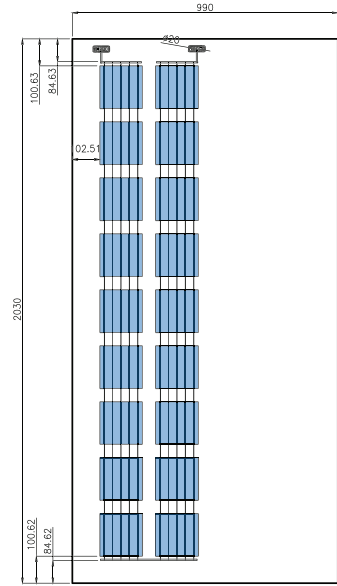

A112

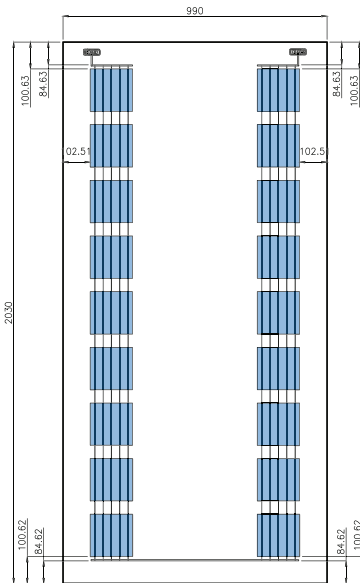

A113

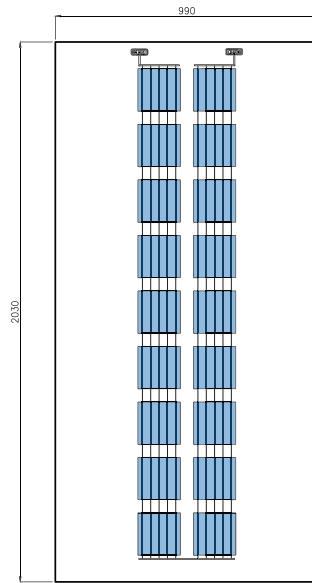

A114

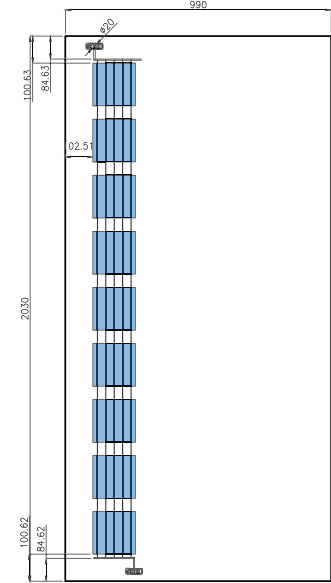

A115

CELL ARRANGEMENTS

RECTANGULAR SHAPE

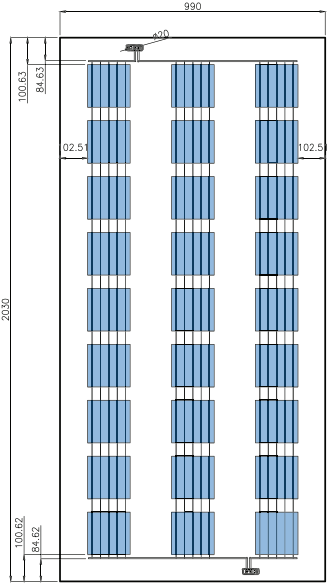

A116

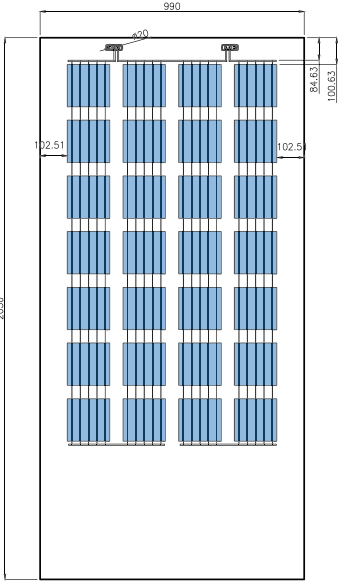

A121

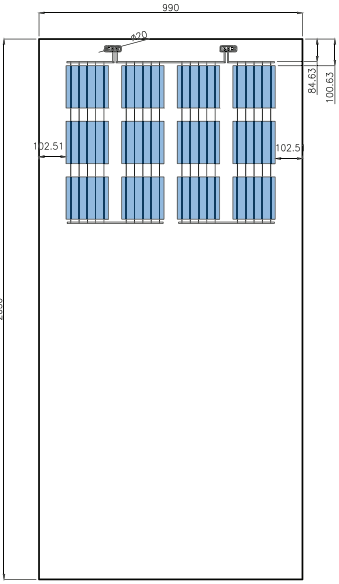

A122

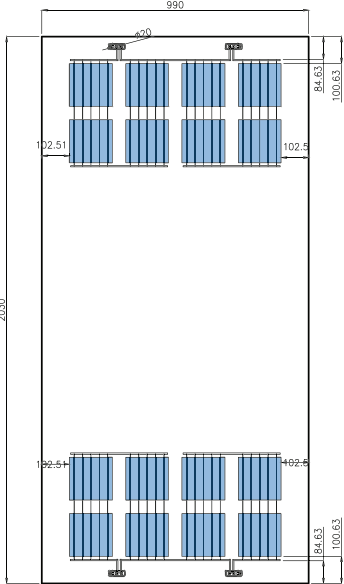

A123

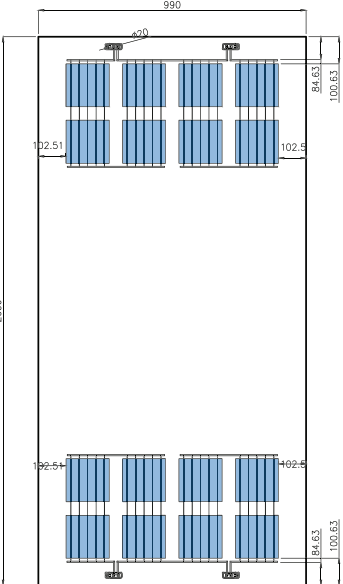

A124

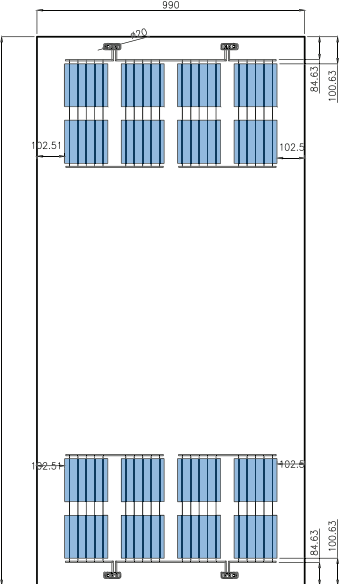

A125

CELL ARRANGEMENTS

RECTANGULAR SHAPE

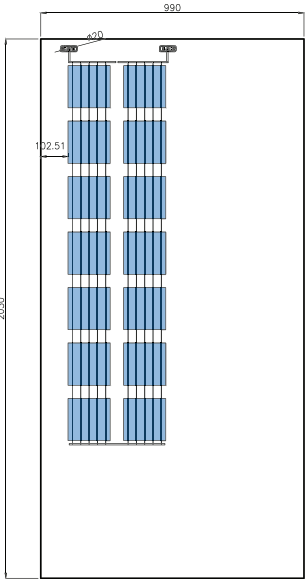

A126

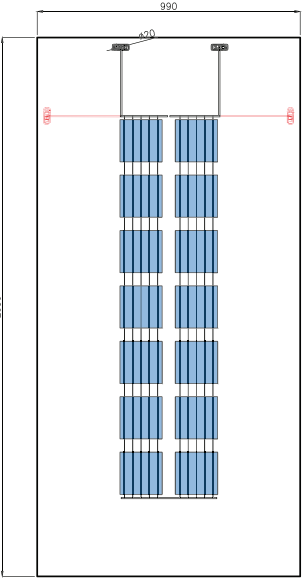

A127

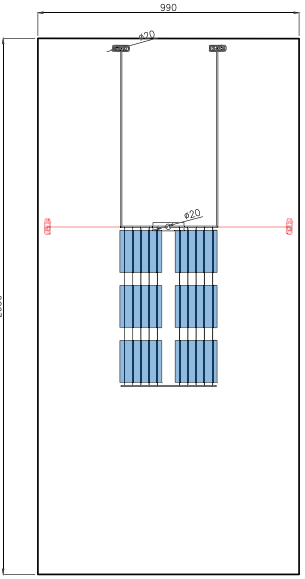

A128

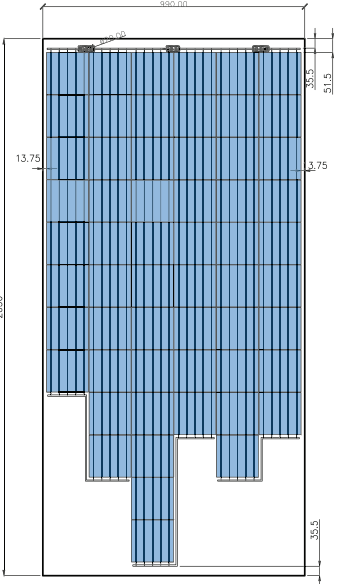

A41

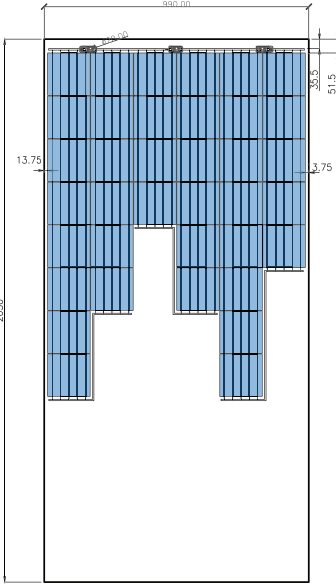

A42

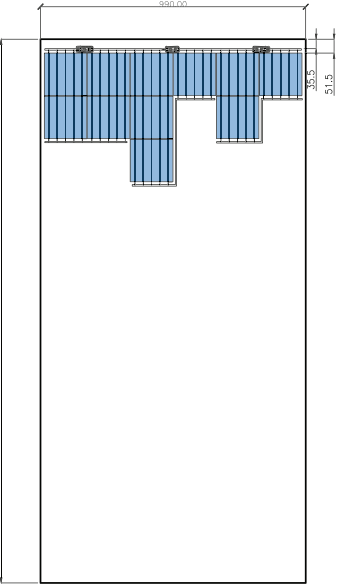

A43

CELL ARRANGEMENTS

RECTANGULAR SHAPE

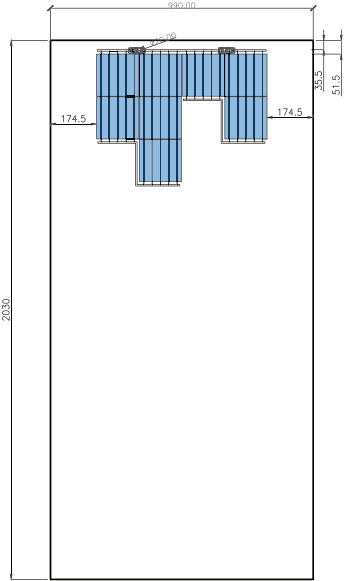

A44

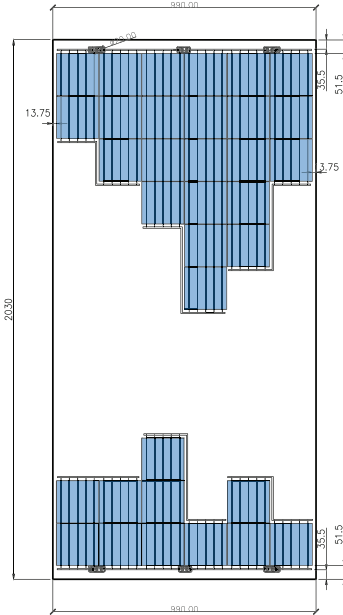

A45

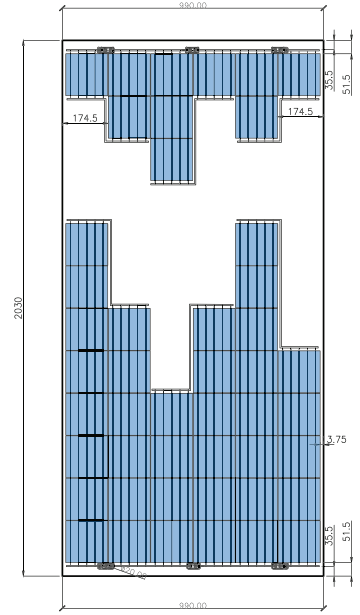

A46

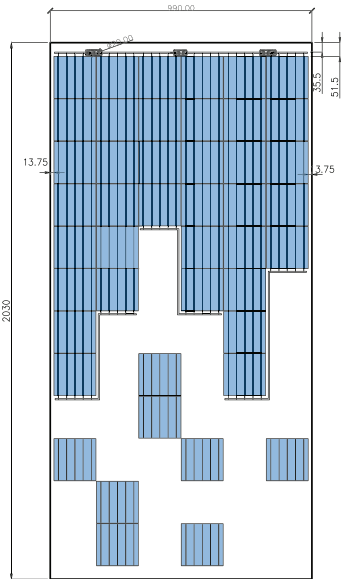

A51

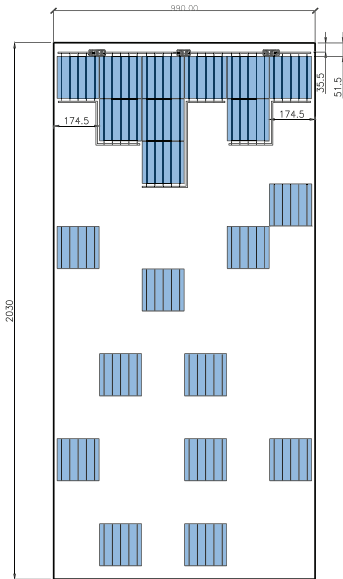

A52

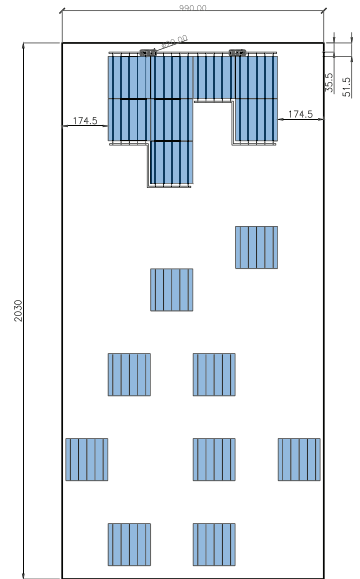

A53

CELL ARRANGEMENTS

RECTANGULAR SHAPE

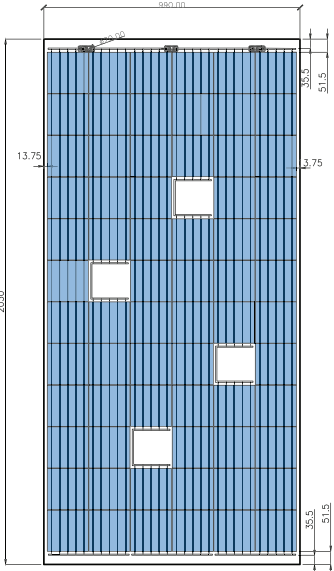

A54

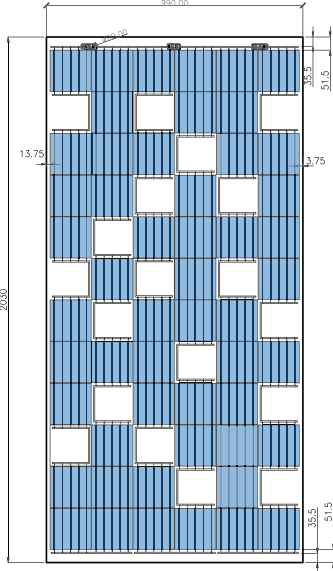

A55

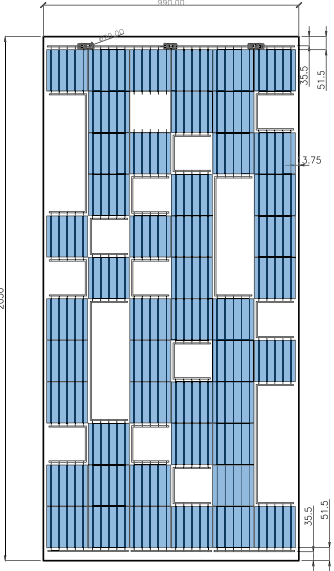

A56

CELL ARRANGEMENTS

SQUARE SHAPE

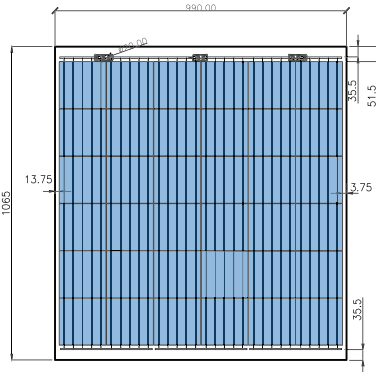

B1

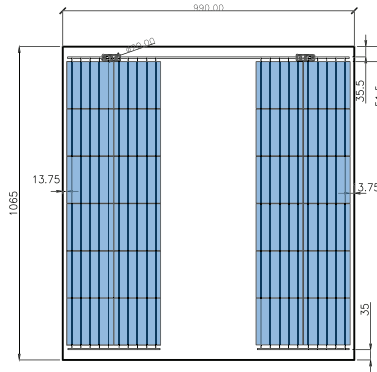

B2

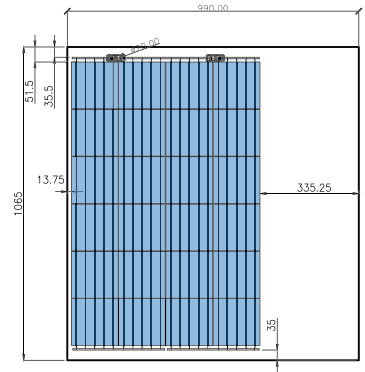

B3

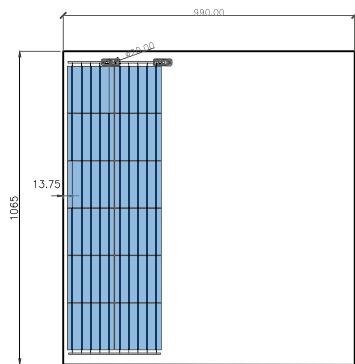

B4

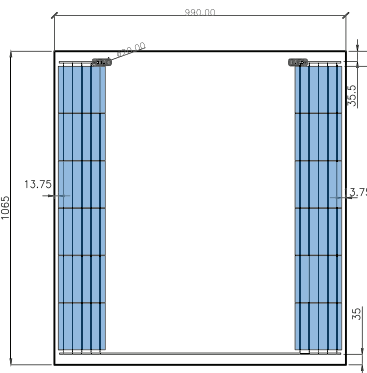

B5

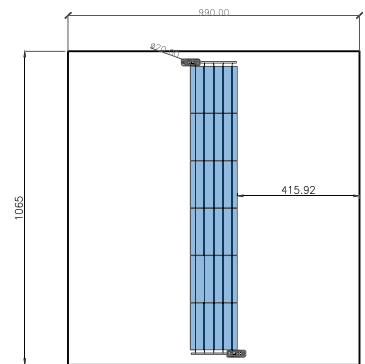

B6

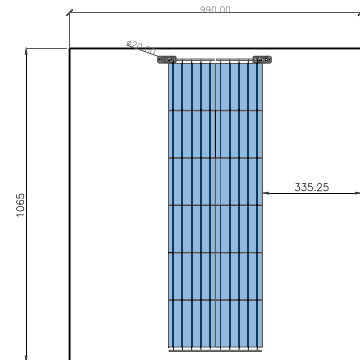

B7

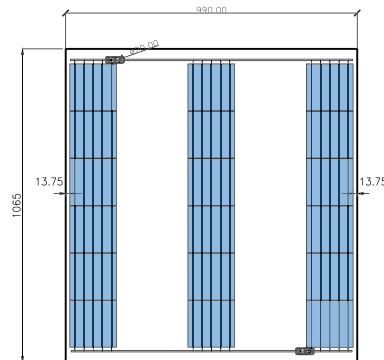

B8

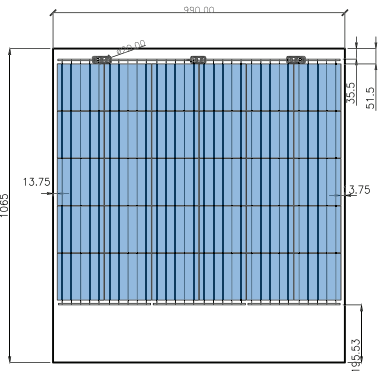

B21

CELL ARRANGEMENTS

SQUARE SHAPE

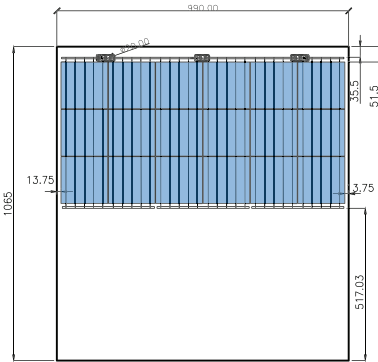

B22

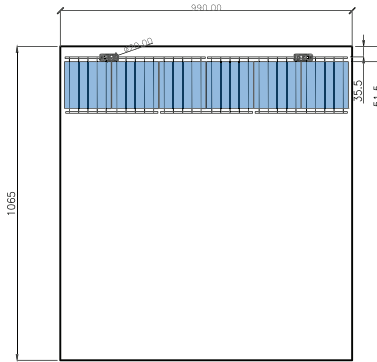

B23

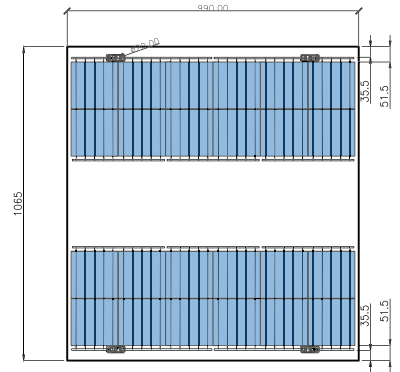

B24

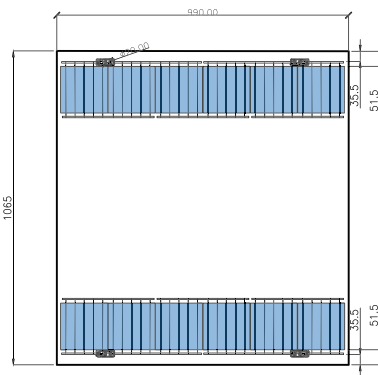

B25

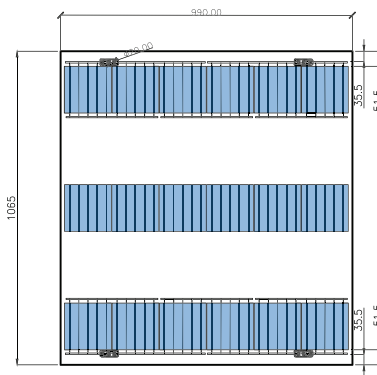

B26

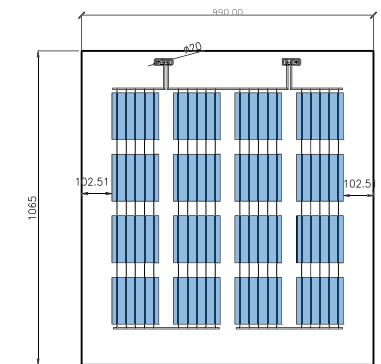

B31

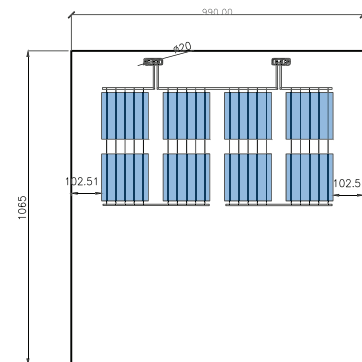

B32

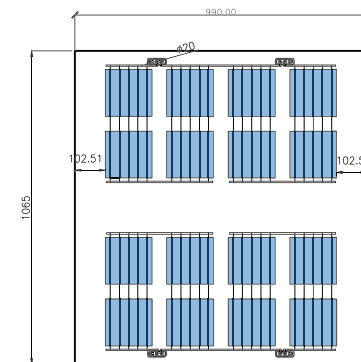

B33

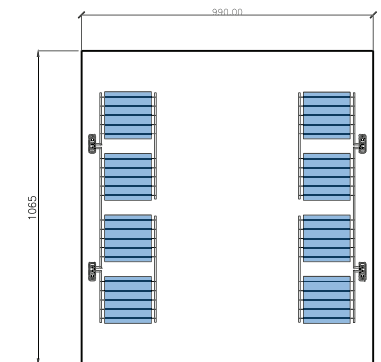

B34

CELL ARRANGEMENTS

SQUARE SHAPE

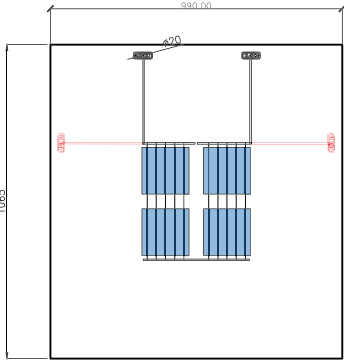

B35

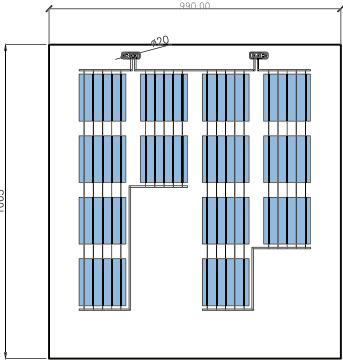

B36

CELL ARRANGEMENTS

CIRCULAR SHAPE

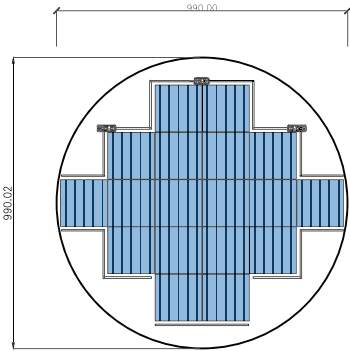

C11

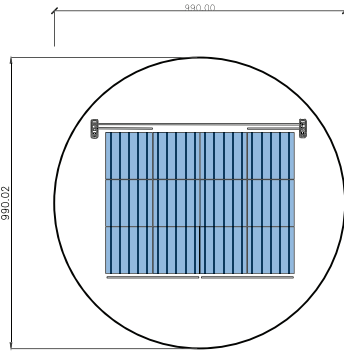

C12

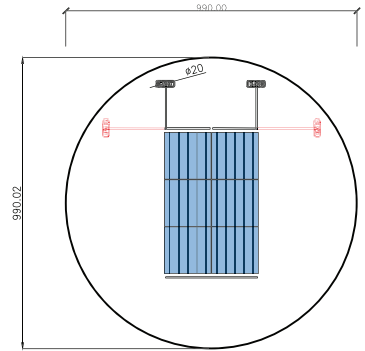

C13

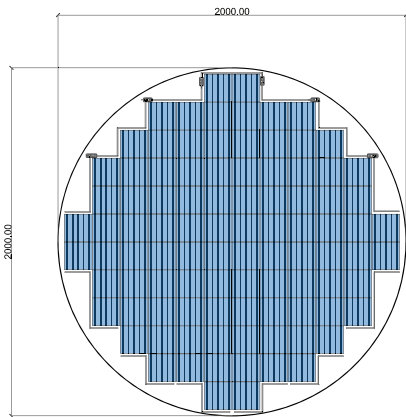

C21

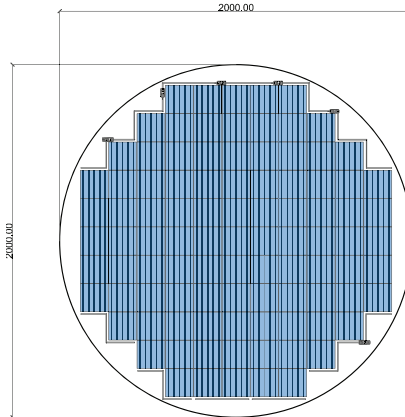

C22

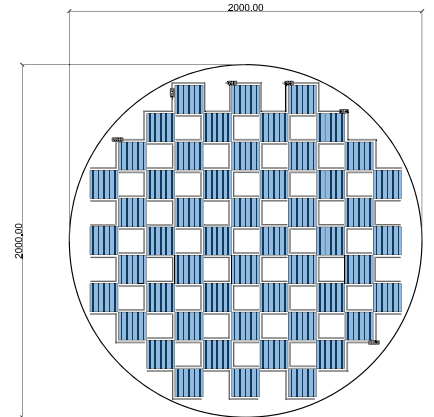

C23

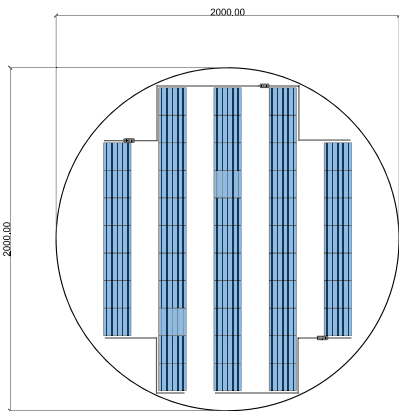

C24

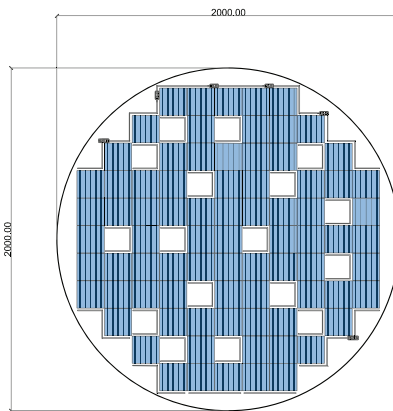

C25

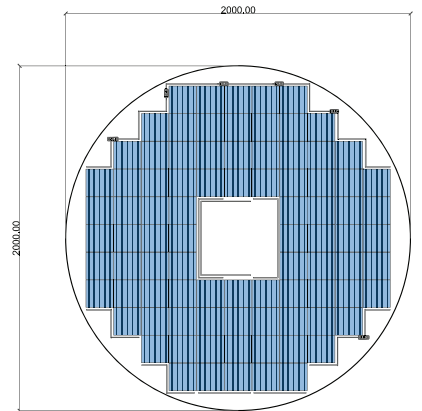

C31

CELL ARRANGEMENTS

CIRCULAR SHAPE

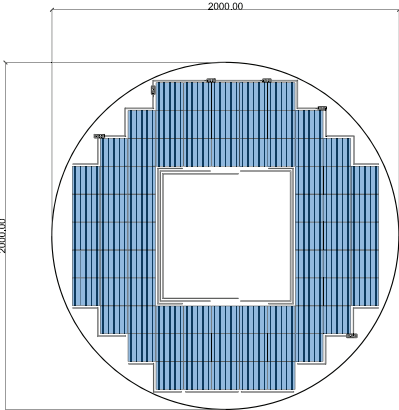

C32

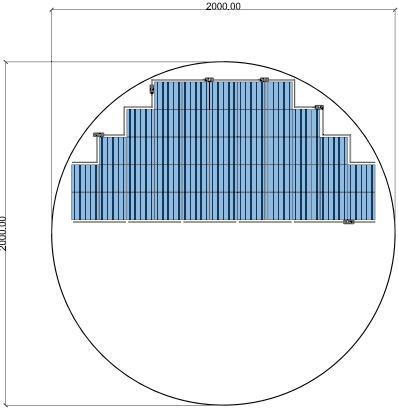

C33

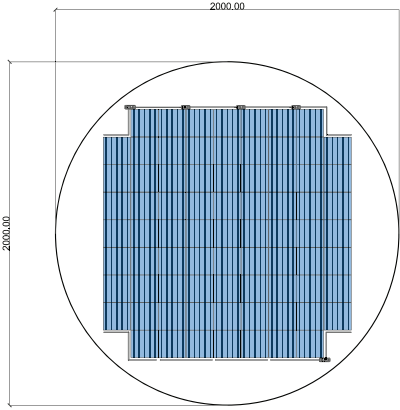

C34

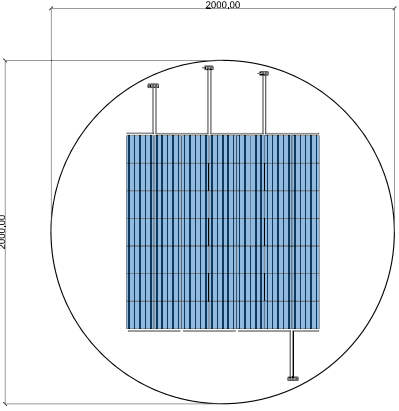

C35

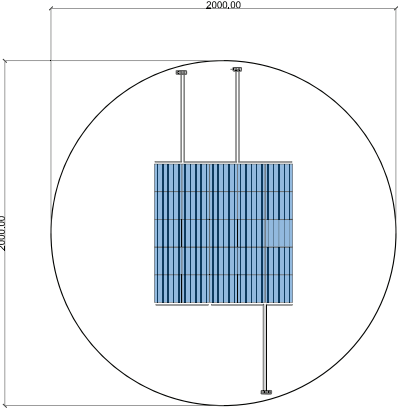

C36

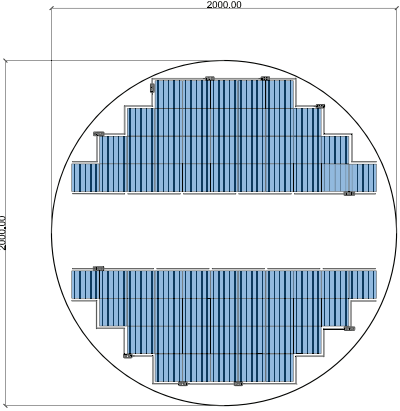

C41

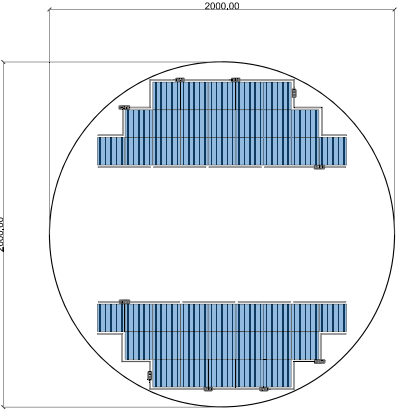

C42

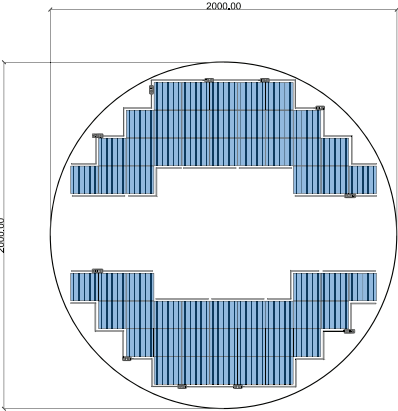

C43

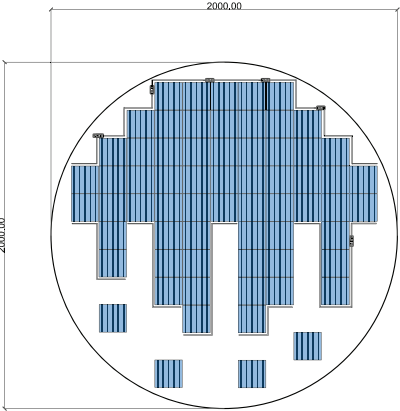

C51

CELL ARRANGEMENTS

CIRCULAR SHAPE

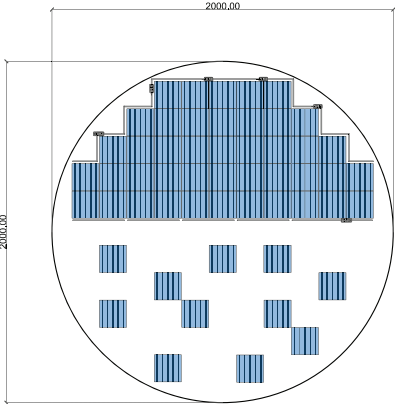

C52

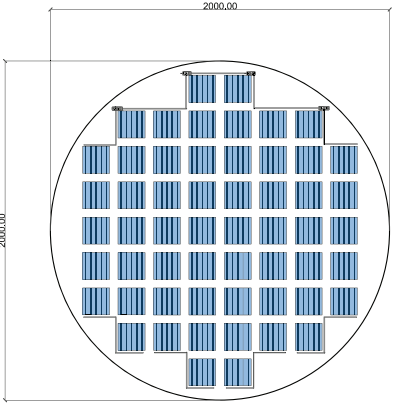

C53

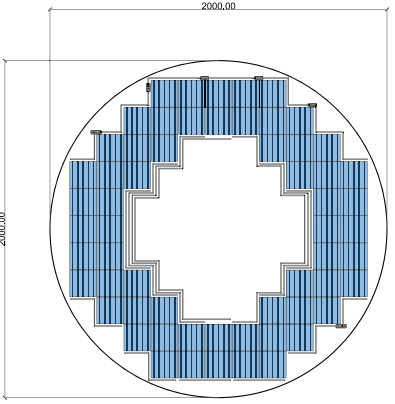

C54

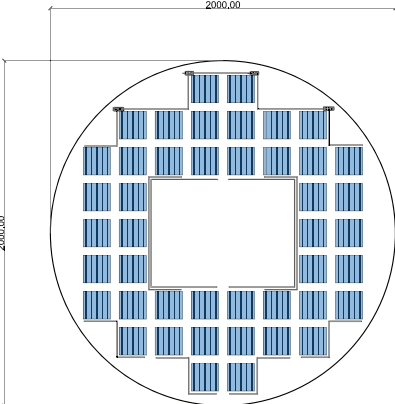

C55

CELL ARRANGEMENTS

ISOSCELES TRIANGULE SHAPE

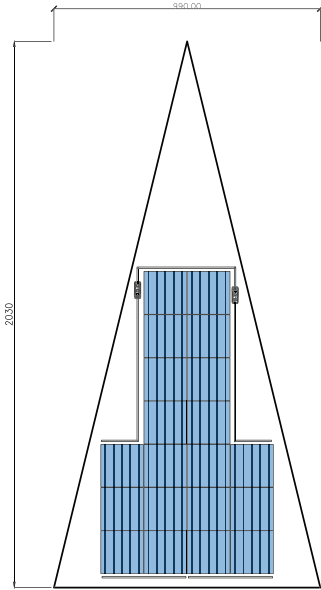

C14

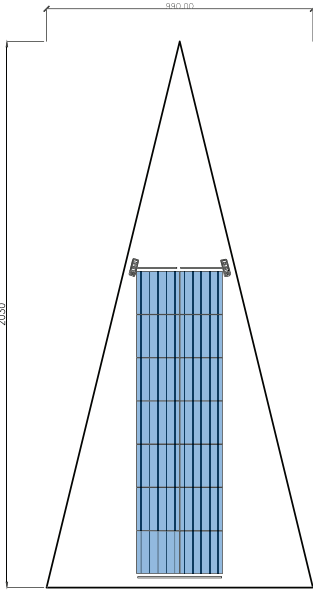

C15

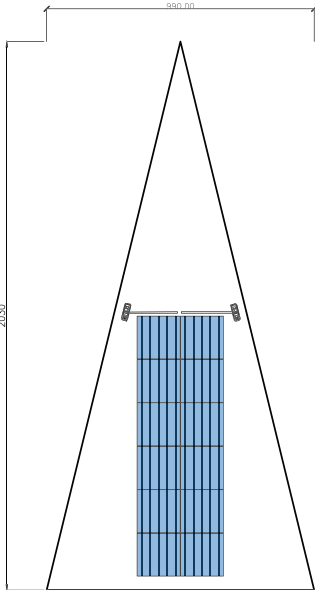

C16

CELL ARRANGEMENTS

EQUILATERAL TRIANGLE SHAPE

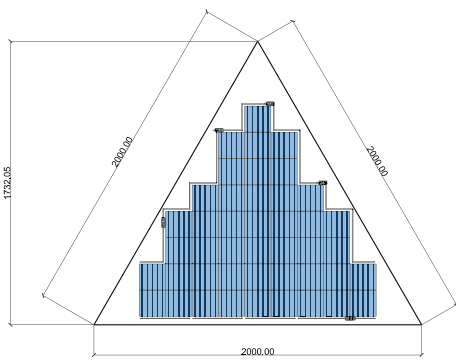

C61

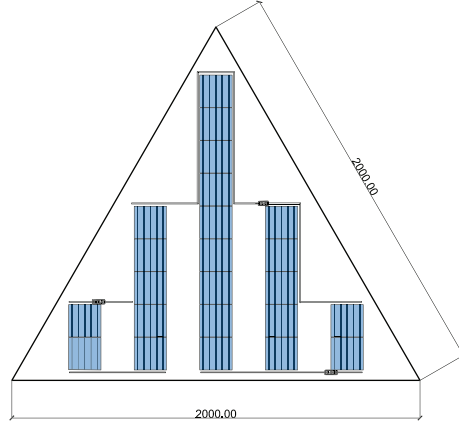

C62

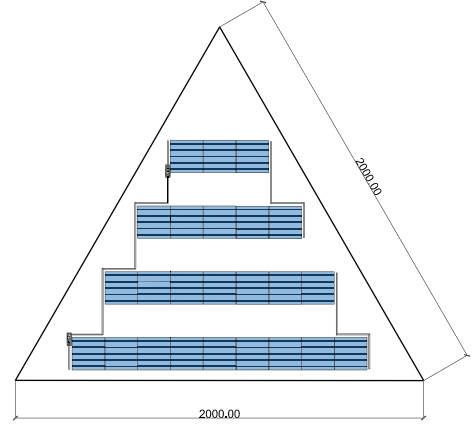

C63

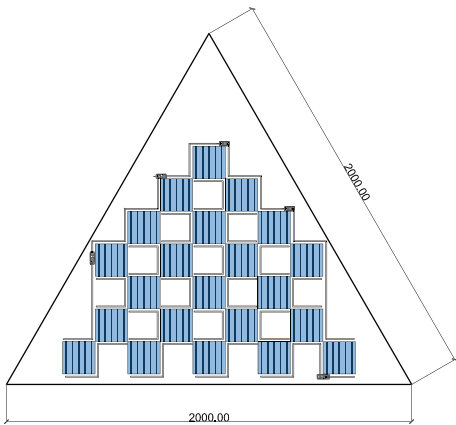

C64

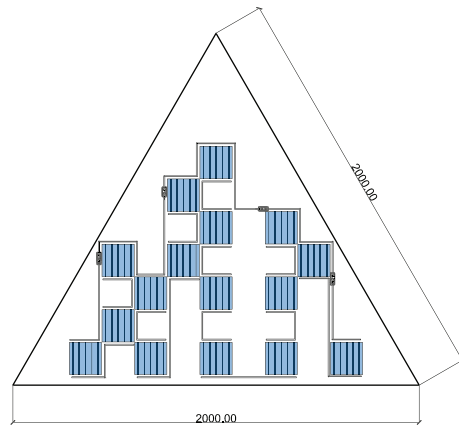

C65

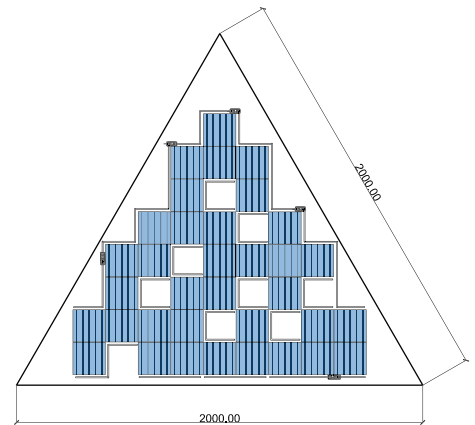

C66

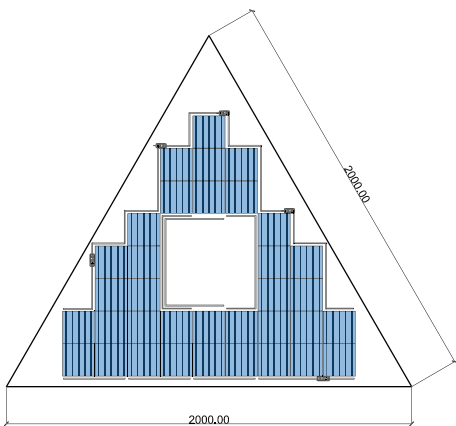

C71

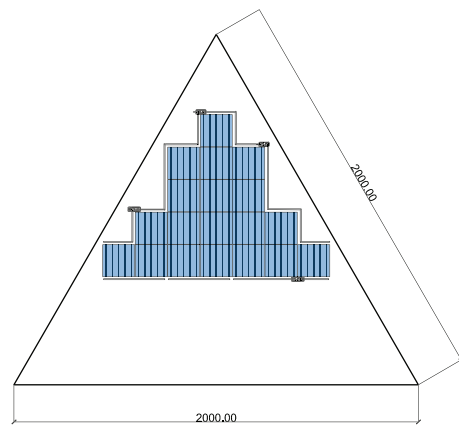

C72

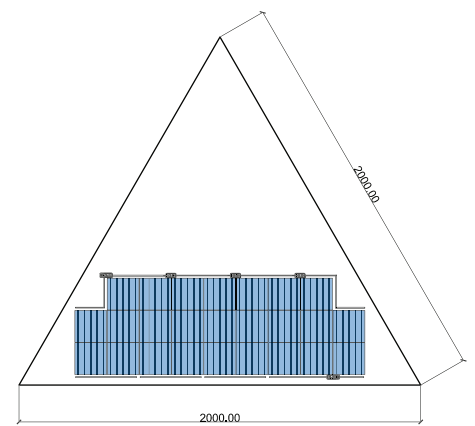

C73

CELL ARRANGEMENTS

EQUILATERAL TRIANGLE SHAPE

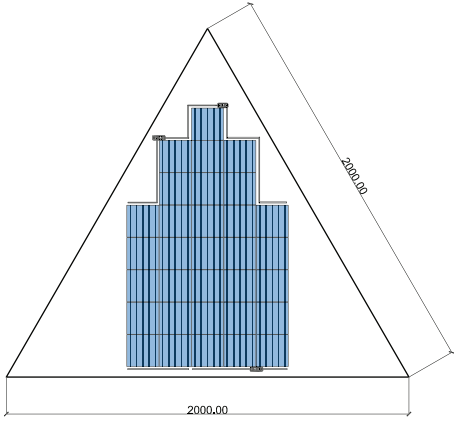

C74

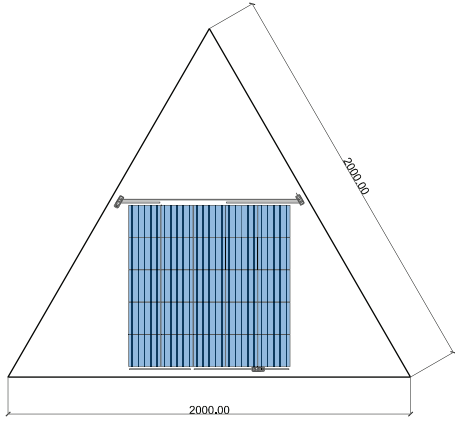

C75

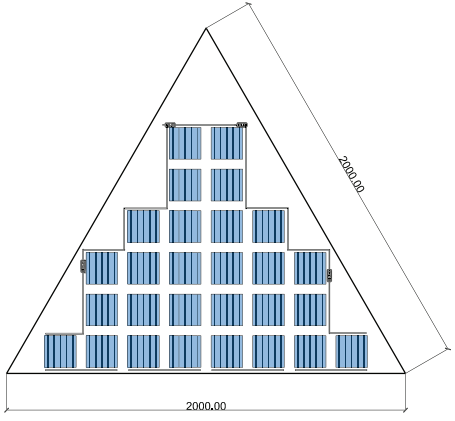

C76

CELL ARRANGEMENTS

HEXAGONAL SHAPE

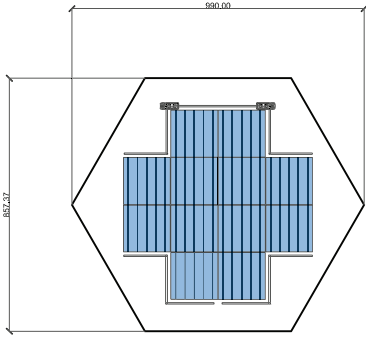

C17

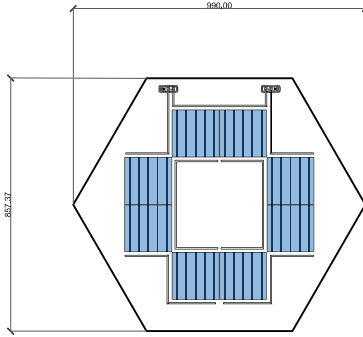

C18

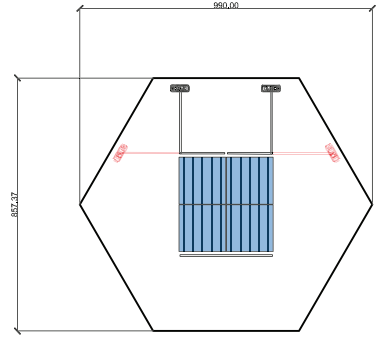

C19

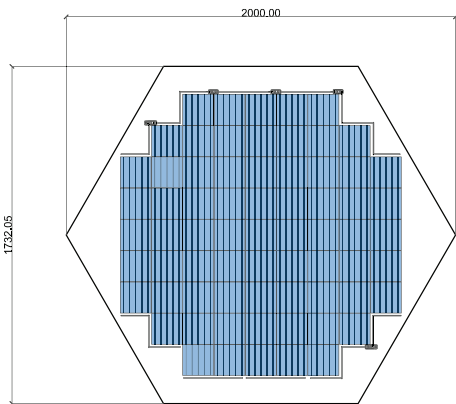

C81

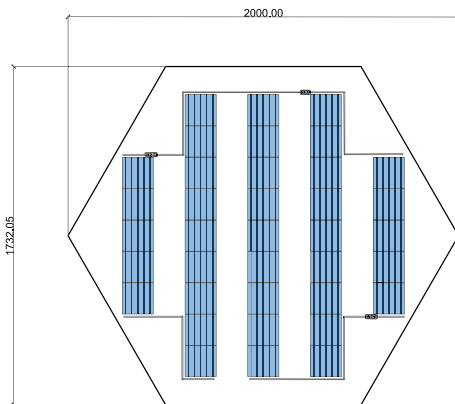

C82

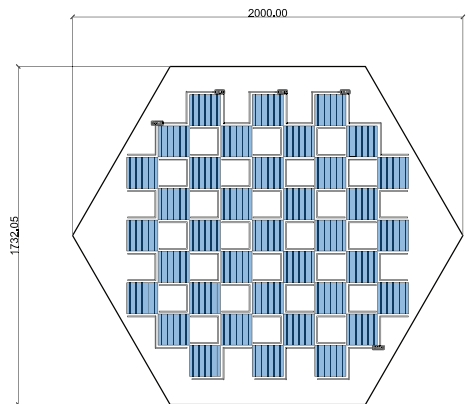

C83

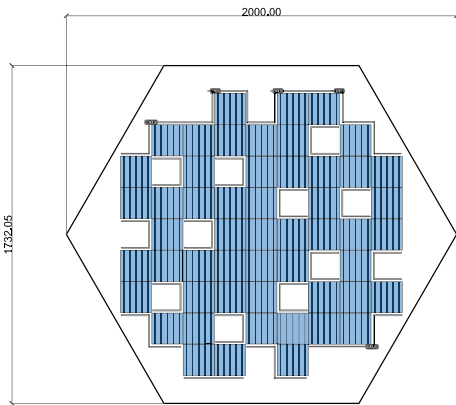

C84

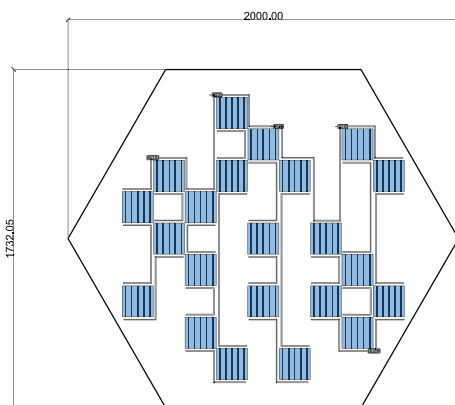

C85

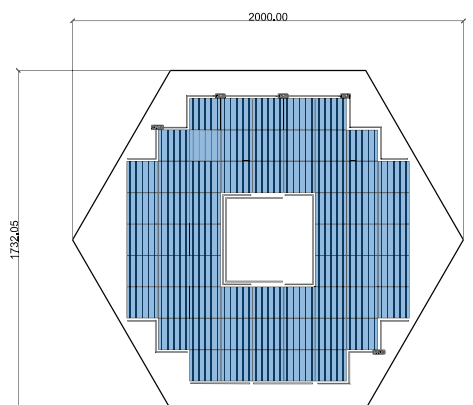

C91

CELL ARRANGEMENTS

HEXAGONAL SHAPE

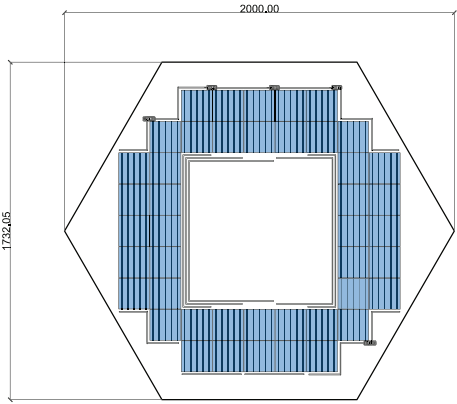

C92

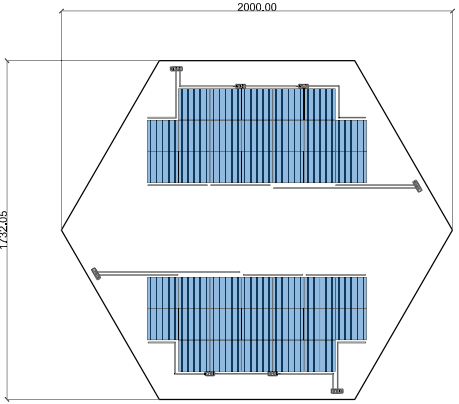

C93

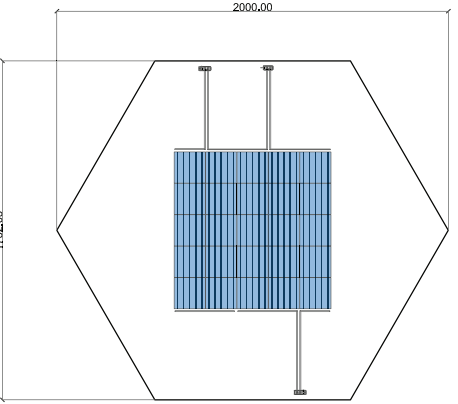

C94

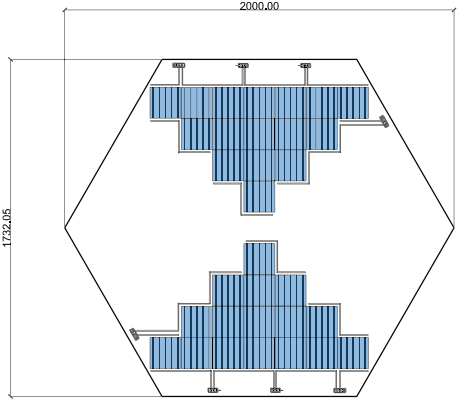

C95

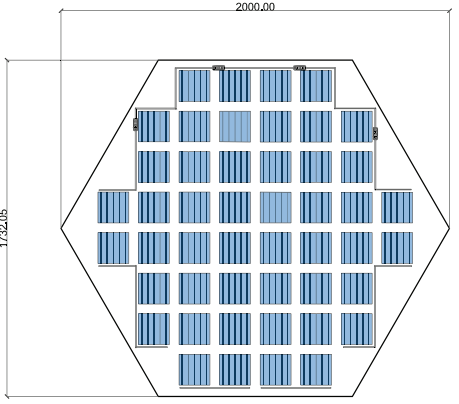

C96

CELL ARRANGEMENTS

PARALLELOGRAM SHAPE

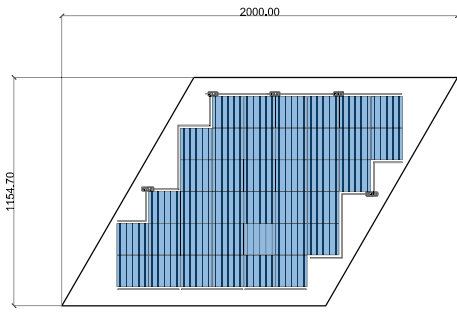

C101

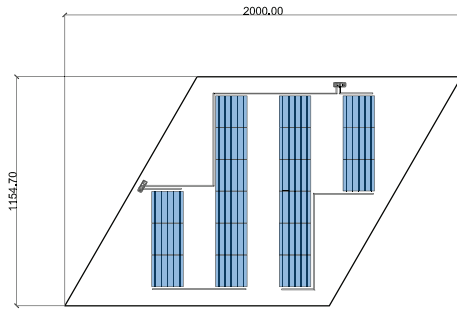

C102

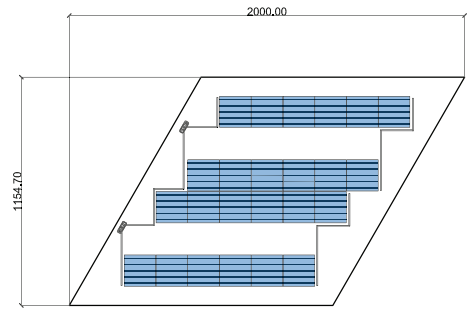

C103

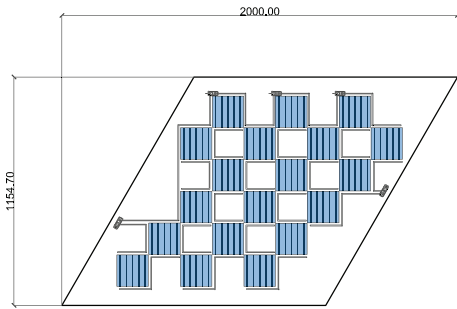

C104

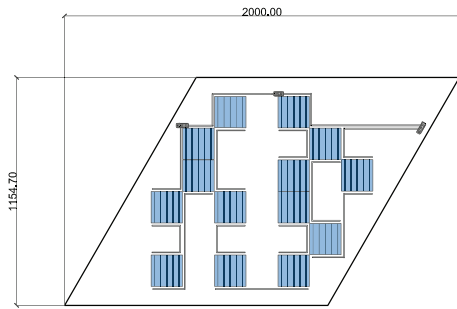

C105

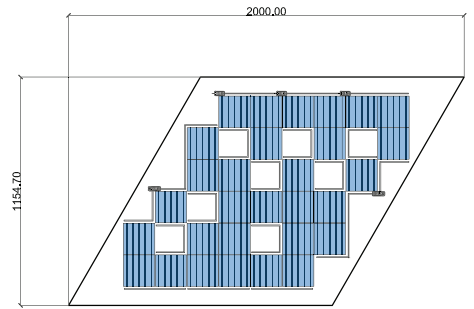

C106

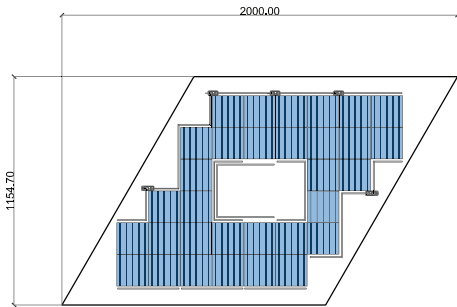

C111

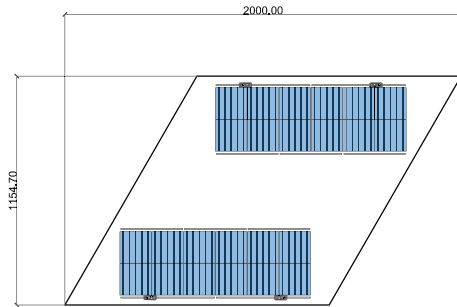

C112

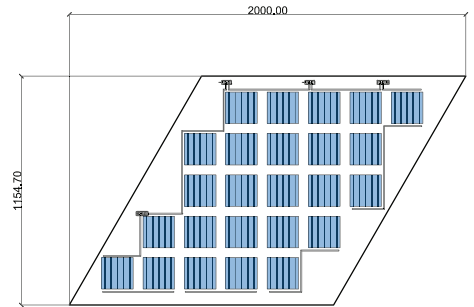

C113

CELL ARRANGEMENTS

PARALLELOGRAM SHAPE

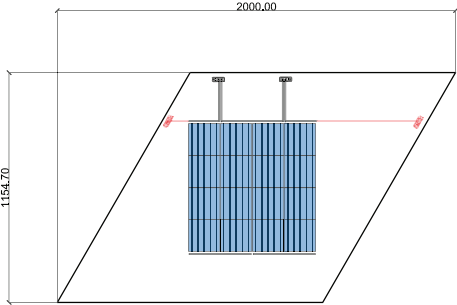

C114

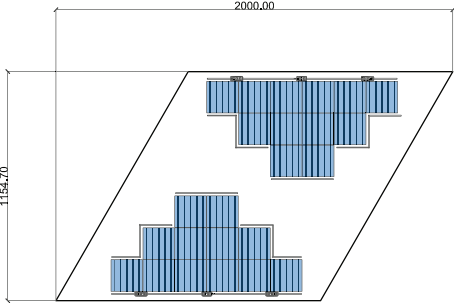

C115

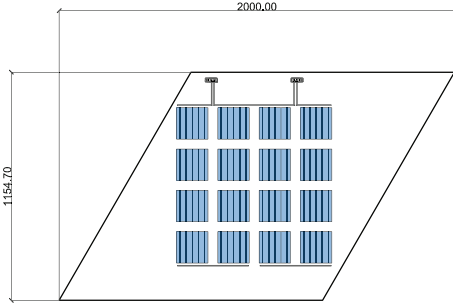

C116

SOLAR GLASS & JUNCTION BOX

LAMINATED SOLAR GLASS

In the Mitrex solar glass, the position of the junction box can be at the front, top or back of the glass depending on the project needs.

Placing the junction box on the top surface ensures easy accessibility for maintenance and inspection, simplifying wiring and connections while preserving the clean appearance of the glass front.

On the other hand, a front-mounted junction box allows for convenient access while maintaining a sleek and integrated look. However, it might be more visible, impacting the overall aesthetics.

Additionally, positioning the junction box at the back conceals wiring and connections, providing a streamlined and unobstructed front surface, enhancing the visual appeal of the structure. The choice of placement involves a careful balance between accessibility, aesthetics, and functionality, each position influencing the efficiency and visual impact of the solar setup.

JUNCTION BOX ON TOP

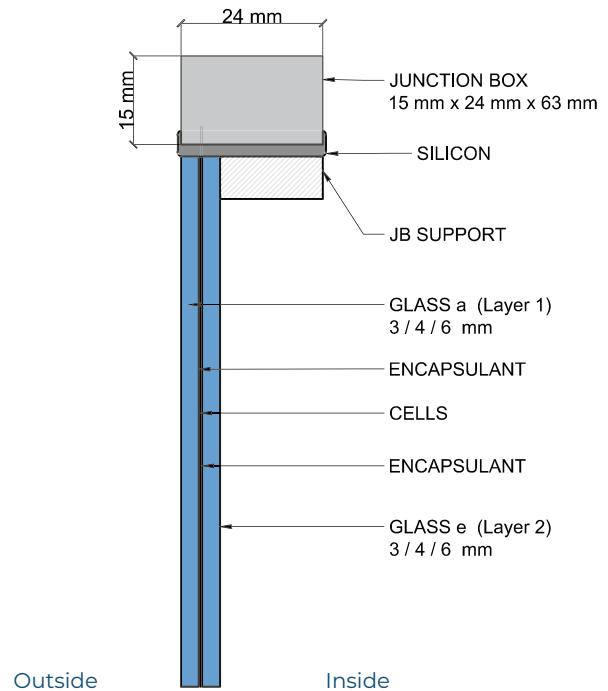

SOLAR GLASS & JUNCTION BOX

LAMINATED SOLAR GLASS

JUNCTION BOX ON THE FACE

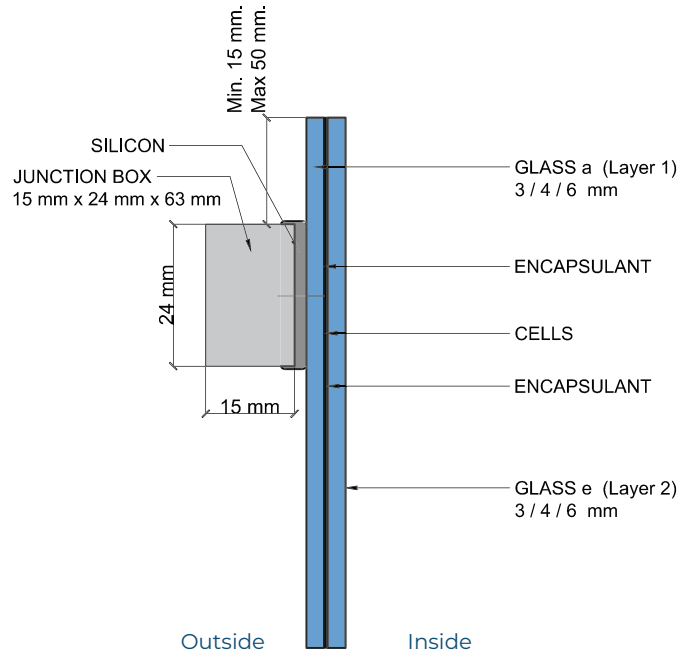

JUNCTION BOX AT THE BACK

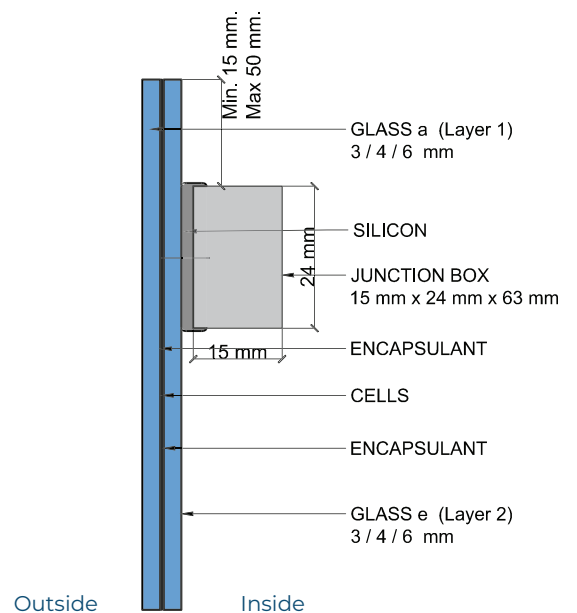

SOLAR GLASS & JUNCTION BOX

IGU SOLAR GLASS DOUBLE LAYER

JUNCTION BOX ON TOP

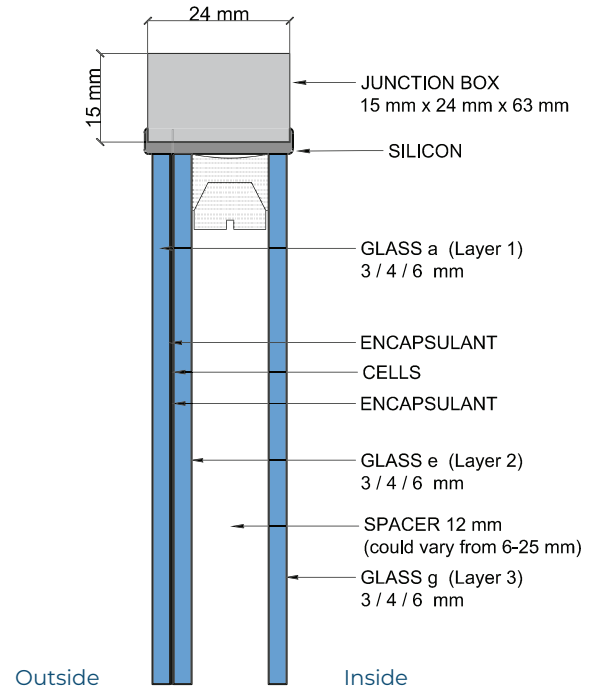

JUNCTION BOX ON THE FACE

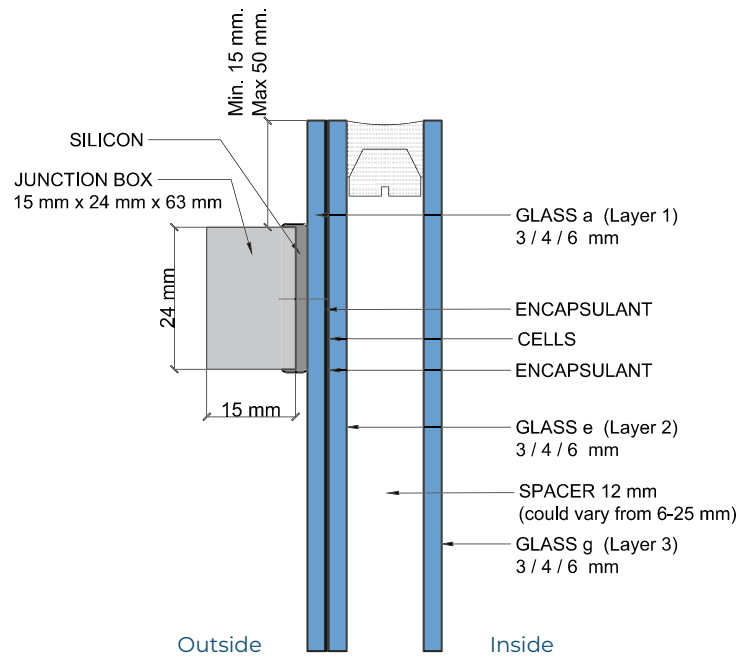

SOLAR GLASS & JUNCTION BOX

IGU SOLAR GLASS TRIPLE LAYER

JUNCTION BOX ON TOP

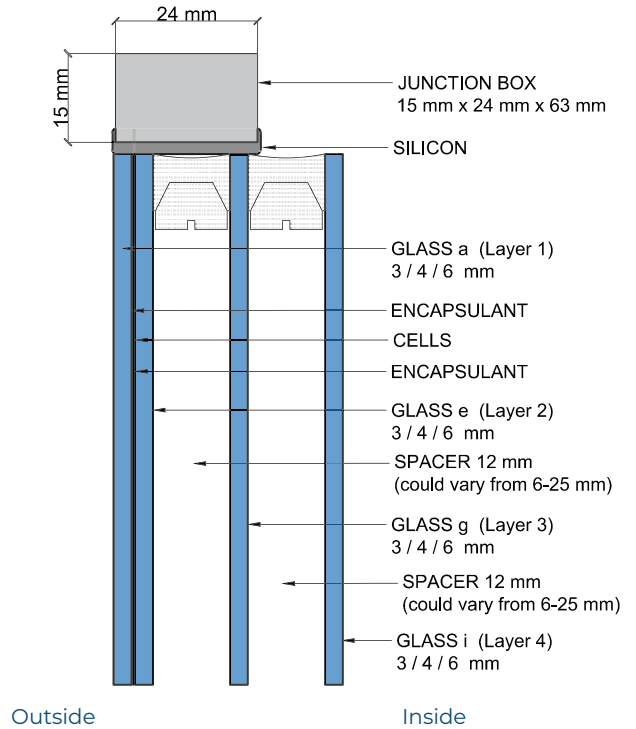

JUNCTION BOX ON THE FACE

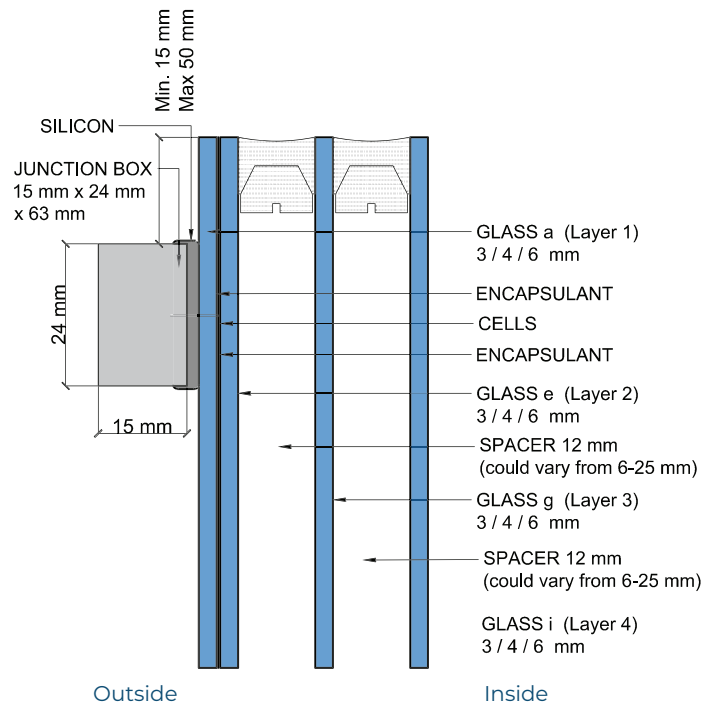

TECHNICAL DATA

GLASS DATASHEET

Non-Active Models

Panel Type	Layers						UV %	Visible Light Transmittance	Total Solar Transmittance	Visible		Solar Heat Gain Coefficient	U-Value (BTU/hrft2F)			Light to Solar Gain
	Class L1	Class L2	Spacer	Class L3	Spacer	Class L4				Exterior	Interior		Gain	Winter	Summer	
	Thickness	Thickness	Size	Thickness	Size	Thickness							Nighttime	Daytime		
LowIron-LowIron	3	3	N/A	N/A	N/A	N/A	0%	91%	83%	8%	8%	86%	1.00	0.90	1.06	
LowIron-LowIron	4	4	N/A	N/A	N/A	N/A	1%	91%	82%	8%	8%	85%	0.99	0.90	1.07	
LowIron-LowIron	6	6	N/A	N/A	N/A	N/A	0%	90%	81%	8%	8%	85%	0.97	0.88	1.06	
LowIron-LowIronLowE	3	3	N/A	N/A	N/A	N/A	0%	76%	38%	10%	9%	45%	1.00	0.90	1.69	
LowIron-LowIronLowE	4	4	N/A	N/A	N/A	N/A	0%	76%	38%	10%	9%	45%	0.99	0.90	1.69	
LowIron-LowIronLowE	6	6	N/A	N/A	N/A	N/A	0%	76%	38%	10%	9%	46%	0.97	0.88	1.65	
LowIron-LowIron-Spacer-Clear	3	3	12	3	N/A	N/A	0%	82%	70%	15%	15%	76%	0.45	0.47	1.08	
LowIron-LowIron-Spacer-Clear	4	4	12	4	N/A	N/A	1%	82%	68%	15%	15%	75%	0.44	0.47	1.09	
LowIron-LowIron-Spacer-Clear	6	6	12	6	N/A	N/A	0%	81%	63%	15%	15%	73%	0.44	0.46	1.11	
LowIron-LowIron-Spacer-LowIron	3	3	12	3	N/A	N/A	0%	84%	76%	15%	15%	78%	0.45	0.47	1.08	
LowIron-LowIron-Spacer-LowIron	4	4	12	4	N/A	N/A	1%	83%	75%	15%	15%	77%	0.44	0.47	1.08	
LowIron-LowIron-Spacer-LowIron	6	6	12	6	N/A	N/A	0%	83%	73%	15%	15%	76%	0.44	0.46	1.09	
LowIron-LowIron-Spacer-LowEClear	3	3	12	3	N/A	N/A	0%	73%	37%	12%	11%	48%	0.24	0.22	1.52	
LowIron-LowIron-Spacer-LowEClear	4	4	12	4	N/A	N/A	0%	73%	36%	12%	11%	48%	0.24	0.22	1.52	
LowIron-LowIron-Spacer-LowEClear	6	6	12	6	N/A	N/A	0%	72%	35%	12%	11%	48%	0.24	0.22	1.50	
LowIron-LowIron-Spacer-LowELowIron	3	3	12	3	N/A	N/A	0%	75%	38%	12%	11%	48%	0.29	0.27	1.56	
LowIron-LowIron-Spacer-LowELowIron	4	4	12	4	N/A	N/A	0%	75%	38%	12%	11%	48%	0.28	0.26	1.56	
LowIron-LowIron-Spacer-LowELowIron	6	6	12	6	N/A	N/A	0%	74%	38%	12%	11%	48%	0.24	0.22	1.54	
LowIron-LowIron-Spacer-Clear-Spacer-Clear	3	3	12	3	12	3	0%	75%	59%	21%	21%	68%	0.29	0.32	1.10	
LowIron-LowIron-Spacer-Clear-Spacer-Clear	4	4	12	4	12	4	1%	74%	56%	21%	21%	67%	0.28	0.32	1.10	
LowIron-LowIron-Spacer-Clear-Spacer-Clear	6	6	12	6	12	6	0%	72%	50%	21%	20%	64%	0.28	0.32	1.13	
LowIron-LowIron-Spacer-LowIron-Spacer-LowIron	3	3	12	3	12	3	0%	77%	69%	21%	21%	72%	0.29	0.32	1.07	
LowIron-LowIron-Spacer-LowIron-Spacer-LowIron	4	4	12	4	12	4	1%	77%	68%	21%	21%	71%	0.28	0.32	1.08	
LowIron-LowIron-Spacer-LowIron-Spacer-LowIron	6	6	12	6	12	6	0%	77%	66%	21%	21%	70%	0.28	0.32	1.10	
LowIron-LowIron-Spacer-LowEClear-Spacer-LowEClear	3	3	12	3	12	3	0%	59%	25%	15%	13%	39%	0.12	0.12	1.51	
LowIron-LowIron-Spacer-LowEClear-Spacer-LowEClear	4	4	12	4	12	4	0%	58%	25%	14%	12%	39%	0.12	0.12	1.49	
LowIron-LowIron-Spacer-LowEClear-Spacer-LowEClear	6	6	12	6	12	6	0%	57%	24%	14%	12%	38%	0.12	0.12	1.50	
LowIron-LowIron-Spacer-LowELowIron-Spacer-LowELowIron	3	3	12	3	12	3	0%	61%	27%	15%	13%	40%	0.12	0.12	1.53	
LowIron-LowIron-Spacer-LowELowIron-Spacer-LowELowIron	4	4	12	4	12	4	0%	61%	27%	15%	13%	40%	0.12	0.12	1.53	
LowIron-LowIron-Spacer-LowELowIron-Spacer-LowELowIron	6	6	12	6	12	6	0%	60%	27%	15%	13%	39%	0.12	0.12	1.54	

Panel Layers LowIron-LowIron			Layers						UV %	Visible Light Transmittance	Total Solar Transmittance	Visible Reflectance		Solar Heat Gain Coefficient	U-Value (BTU/hrft2F)		Light to Solar Gain
Panel Type	Shape	Cell Coverage Area	Glass L1 Thickness	Glass L2 Thickness	Spacer Size	Glass L3 Thickness	Spacer Size	Glass L4 Thickness				Exterior	Interior		Winter Nighttime	Summer Daytime	
C74	Triangle	47%	3	3	N/A	N/A	N/A	N/A	0%	48%	44%	18%	18%	45%	1.00	0.90	1.06
C75	Triangle	37%	3	3	N/A	N/A	N/A	N/A	0%	57%	52%	16%	16%	54%	1.00	0.90	1.06
C76	Triangle	41%	3	3	N/A	N/A	N/A	N/A	0%	53%	49%	17%	17%	50%	1.00	0.90	1.06
C17	Hexagon	48%	3	3	N/A	N/A	N/A	N/A	0%	47%	43%	19%	19%	44%	1.00	0.90	1.06
C18	Hexagon	32%	3	3	N/A	N/A	N/A	N/A	0%	62%	56%	15%	15%	58%	1.00	0.90	1.06
C19	Hexagon	16%	3	3	N/A	N/A	N/A	N/A	0%	76%	70%	12%	12%	72%	1.00	0.90	1.06
C81	Hexagon	68%	3	3	N/A	N/A	N/A	N/A	0%	29%	27%	23%	23%	28%	1.00	0.90	1.06
C82	Hexagon	36%	3	3	N/A	N/A	N/A	N/A	0%	58%	53%	16%	16%	55%	1.00	0.90	1.06
C83	Hexagon	36%	3	3	N/A	N/A	N/A	N/A	0%	58%	53%	16%	16%	55%	1.00	0.90	1.06
C84	Hexagon	52%	3	3	N/A	N/A	N/A	N/A	0%	43%	40%	19%	19%	41%	1.00	0.90	1.06
C85	Hexagon	22%	3	3	N/A	N/A	N/A	N/A	0%	71%	65%	13%	13%	67%	1.00	0.90	1.06
C91	Hexagon	69%	3	3	N/A	N/A	N/A	N/A	0%	28%	26%	23%	23%	27%	1.00	0.90	1.06
C92	Hexagon	53%	3	3	N/A	N/A	N/A	N/A	0%	43%	39%	20%	20%	40%	1.00	0.90	1.06
C93	Hexagon	37%	3	3	N/A	N/A	N/A	N/A	0%	57%	52%	16%	16%	54%	1.00	0.90	1.06
C94	Hexagon	10%	3	3	N/A	N/A	N/A	N/A	0%	82%	75%	10%	10%	78%	1.00	0.90	1.06
C95	Hexagon	32%	3	3	N/A	N/A	N/A	N/A	0%	62%	57%	15%	15%	59%	1.00	0.90	1.06
C96	Hexagon	47%	3	3	N/A	N/A	N/A	N/A	0%	48%	44%	18%	18%	45%	1.00	0.90	1.06
C101	Parallelogram	63%	3	3	N/A	N/A	N/A	N/A	0%	34%	31%	22%	22%	32%	1.00	0.90	1.06
C102	Parallelogram	30%	3	3	N/A	N/A	N/A	N/A	0%	64%	58%	15%	15%	60%	1.00	0.90	1.06
C103	Parallelogram	37%	3	3	N/A	N/A	N/A	N/A	0%	58%	53%	16%	16%	55%	1.00	0.90	1.06
C104	Parallelogram	32%	3	3	N/A	N/A	N/A	N/A	0%	62%	57%	15%	15%	59%	1.00	0.90	1.06
C105	Parallelogram	23%	3	3	N/A	N/A	N/A	N/A	0%	70%	64%	13%	13%	66%	1.00	0.90	1.06
C106	Parallelogram	50%	3	3	N/A	N/A	N/A	N/A	0%	46%	42%	19%	19%	43%	1.00	0.90	1.06
C111	Parallelogram	53%	3	3	N/A	N/A	N/A	N/A	0%	43%	39%	20%	20%	40%	1.00	0.90	1.06
C112	Parallelogram	40%	3	3	N/A	N/A	N/A	N/A	0%	55%	50%	17%	17%	52%	1.00	0.90	1.06
C113	Parallelogram	43%	3	3	N/A	N/A	N/A	N/A	0%	52%	47%	18%	18%	49%	1.00	0.90	1.06
C114	Parallelogram	27%	3	3	N/A	N/A	N/A	N/A	0%	67%	61%	14%	14%	63%	1.00	0.90	1.06
C115	Parallelogram	40%	3	3	N/A	N/A	N/A	N/A	0%	55%	50%	17%	17%	52%	1.00	0.90	1.06
C116	Parallelogram	27%	3	3	N/A	N/A	N/A	N/A	0%	67%	61%	14%	14%	63%	1.00	0.90	1.06

Panel Layers			Layers						UV %	Visible Light Transmittance	Total Solar Transmittance	Visible Reflectance		Solar Heat Gain Coefficient	U-Value (BTU/hrft2F)		Light to Solar Gain
LowIron-LowIron			Class L1	Class L2	Spacer	Class L3	Spacer	Class L4				Exterior	Interior		Winter Nighttime	Summer Daytime	
Panel Type	Shape	Cell Coverage Area	Thickness	Thickness	Size	Thickness	Size	Thickness									
C74	Triangle	47%	4	4	N/A	N/A	N/A	N/A	1%	48%	43%	18%	18%	45%	0.99	0.90	1.07
C75	Triangle	37%	4	4	N/A	N/A	N/A	N/A	1%	57%	52%	16%	16%	54%	0.99	0.90	1.07
C76	Triangle	41%	4	4	N/A	N/A	N/A	N/A	1%	53%	48%	17%	17%	50%	0.99	0.90	1.07
C17	Hexagon	48%	4	4	N/A	N/A	N/A	N/A	1%	47%	42%	19%	19%	44%	0.99	0.90	1.07
C18	Hexagon	32%	4	4	N/A	N/A	N/A	N/A	1%	62%	56%	15%	15%	58%	0.99	0.90	1.07
C19	Hexagon	16%	4	4	N/A	N/A	N/A	N/A	1%	76%	69%	12%	12%	71%	0.99	0.90	1.07
C81	Hexagon	68%	4	4	N/A	N/A	N/A	N/A	0%	29%	26%	23%	23%	27%	0.99	0.90	1.07
C82	Hexagon	36%	4	4	N/A	N/A	N/A	N/A	1%	58%	52%	16%	16%	54%	0.99	0.90	1.07
C83	Hexagon	36%	4	4	N/A	N/A	N/A	N/A	1%	58%	52%	16%	16%	54%	0.99	0.90	1.07
C84	Hexagon	52%	4	4	N/A	N/A	N/A	N/A	0%	43%	39%	19%	19%	41%	0.99	0.90	1.07
C85	Hexagon	22%	4	4	N/A	N/A	N/A	N/A	1%	71%	64%	13%	13%	67%	0.99	0.90	1.07
C91	Hexagon	69%	4	4	N/A	N/A	N/A	N/A	0%	28%	25%	23%	23%	26%	0.99	0.90	1.07
C92	Hexagon	53%	4	4	N/A	N/A	N/A	N/A	0%	43%	38%	20%	20%	40%	0.99	0.90	1.07
C93	Hexagon	37%	4	4	N/A	N/A	N/A	N/A	1%	57%	51%	16%	16%	53%	0.99	0.90	1.07
C94	Hexagon	10%	4	4	N/A	N/A	N/A	N/A	1%	82%	74%	10%	10%	77%	0.99	0.90	1.07
C95	Hexagon	32%	4	4	N/A	N/A	N/A	N/A	1%	62%	56%	15%	15%	58%	0.99	0.90	1.07
C96	Hexagon	47%	4	4	N/A	N/A	N/A	N/A	1%	48%	43%	18%	18%	45%	0.99	0.90	1.07
C101	Parallelogram	63%	4	4	N/A	N/A	N/A	N/A	0%	34%	30%	22%	22%	31%	0.99	0.90	1.07
C102	Parallelogram	30%	4	4	N/A	N/A	N/A	N/A	1%	64%	57%	15%	15%	60%	0.99	0.90	1.07
C103	Parallelogram	37%	4	4	N/A	N/A	N/A	N/A	1%	58%	52%	16%	16%	54%	0.99	0.90	1.07
C104	Parallelogram	32%	4	4	N/A	N/A	N/A	N/A	1%	62%	56%	15%	15%	58%	0.99	0.90	1.07
C105	Parallelogram	23%	4	4	N/A	N/A	N/A	N/A	1%	70%	63%	13%	13%	65%	0.99	0.90	1.07
C106	Parallelogram	50%	4	4	N/A	N/A	N/A	N/A	1%	46%	41%	19%	19%	43%	0.99	0.90	1.07
C111	Parallelogram	53%	4	4	N/A	N/A	N/A	N/A	0%	43%	38%	20%	20%	40%	0.99	0.90	1.07
C112	Parallelogram	40%	4	4	N/A	N/A	N/A	N/A	1%	55%	49%	17%	17%	51%	0.99	0.90	1.07
C113	Parallelogram	43%	4	4	N/A	N/A	N/A	N/A	1%	52%	47%	18%	18%	48%	0.99	0.90	1.07
C114	Parallelogram	27%	4	4	N/A	N/A	N/A	N/A	1%	67%	60%	14%	14%	62%	0.99	0.90	1.07
C115	Parallelogram	40%	4	4	N/A	N/A	N/A	N/A	1%	55%	49%	17%	17%	51%	0.99	0.90	1.07
C116	Parallelogram	27%	4	4	N/A	N/A	N/A	N/A	1%	67%	60%	14%	14%	62%	0.99	0.90	1.07

Panel Layers LowIron-LowIron			Layers							UV %	Visible Light Transmittance	Total Solar Transmittance	Visible Reflectance		Solar Heat Gain Coefficient	U-Value (BTU/hrft2F)		Light to Solar Gain
Panel Type	Shape	Cell Coverage Area	Glass L1 Thickness	Glass L2 Thickness	Spacer Size	Glass L3 Thickness	Spacer Size	Glass L4 Thickness	Exterior				Interior	Winter Nighttime		Summer Daytime		
C74	Triangle	47%	6	6	N/A	N/A	N/A	N/A	0%	47%	43%	18%	18%	45%	0.97	0.88	1.06	
C75	Triangle	37%	6	6	N/A	N/A	N/A	N/A	0%	57%	51%	16%	16%	54%	0.97	0.88	1.06	
C76	Triangle	41%	6	6	N/A	N/A	N/A	N/A	0%	53%	47%	17%	17%	50%	0.97	0.88	1.06	
C17	Hexagon	48%	6	6	N/A	N/A	N/A	N/A	0%	47%	42%	19%	19%	44%	0.97	0.88	1.06	
C18	Hexagon	32%	6	6	N/A	N/A	N/A	N/A	0%	61%	55%	15%	15%	58%	0.97	0.88	1.06	
C19	Hexagon	16%	6	6	N/A	N/A	N/A	N/A	0%	76%	68%	12%	12%	71%	0.97	0.88	1.06	
C81	Hexagon	68%	6	6	N/A	N/A	N/A	N/A	0%	29%	26%	23%	23%	27%	0.97	0.88	1.06	
C82	Hexagon	36%	6	6	N/A	N/A	N/A	N/A	0%	57%	51%	16%	16%	54%	0.97	0.88	1.06	
C83	Hexagon	36%	6	6	N/A	N/A	N/A	N/A	0%	57%	51%	16%	16%	54%	0.97	0.88	1.06	
C84	Hexagon	52%	6	6	N/A	N/A	N/A	N/A	0%	43%	39%	19%	19%	41%	0.97	0.88	1.06	
C85	Hexagon	22%	6	6	N/A	N/A	N/A	N/A	0%	70%	63%	13%	13%	67%	0.97	0.88	1.06	
C91	Hexagon	69%	6	6	N/A	N/A	N/A	N/A	0%	28%	25%	23%	23%	26%	0.97	0.88	1.06	
C92	Hexagon	53%	6	6	N/A	N/A	N/A	N/A	0%	42%	38%	20%	20%	40%	0.97	0.88	1.06	
C93	Hexagon	37%	6	6	N/A	N/A	N/A	N/A	0%	56%	51%	16%	16%	53%	0.97	0.88	1.06	
C94	Hexagon	10%	6	6	N/A	N/A	N/A	N/A	0%	81%	73%	10%	10%	77%	0.97	0.88	1.06	
C95	Hexagon	32%	6	6	N/A	N/A	N/A	N/A	0%	62%	55%	15%	15%	58%	0.97	0.88	1.06	
C96	Hexagon	47%	6	6	N/A	N/A	N/A	N/A	0%	47%	43%	18%	18%	45%	0.97	0.88	1.06	
C101	Parallelogram	63%	6	6	N/A	N/A	N/A	N/A	0%	33%	30%	22%	22%	31%	0.97	0.88	1.06	
C102	Parallelogram	30%	6	6	N/A	N/A	N/A	N/A	0%	63%	57%	15%	15%	60%	0.97	0.88	1.06	
C103	Parallelogram	37%	6	6	N/A	N/A	N/A	N/A	0%	57%	51%	16%	16%	54%	0.97	0.88	1.06	
C104	Parallelogram	32%	6	6	N/A	N/A	N/A	N/A	0%	62%	55%	15%	15%	58%	0.97	0.88	1.06	
C105	Parallelogram	23%	6	6	N/A	N/A	N/A	N/A	0%	69%	62%	13%	13%	65%	0.97	0.88	1.06	
C106	Parallelogram	50%	6	6	N/A	N/A	N/A	N/A	0%	45%	41%	19%	19%	43%	0.97	0.88	1.06	
C111	Parallelogram	53%	6	6	N/A	N/A	N/A	N/A	0%	42%	38%	20%	20%	40%	0.97	0.88	1.06	
C112	Parallelogram	40%	6	6	N/A	N/A	N/A	N/A	0%	54%	49%	17%	17%	51%	0.97	0.88	1.06	
C113	Parallelogram	43%	6	6	N/A	N/A	N/A	N/A	0%	51%	46%	18%	18%	48%	0.97	0.88	1.06	
C114	Parallelogram	27%	6	6	N/A	N/A	N/A	N/A	0%	66%	59%	14%	14%	62%	0.97	0.88	1.06	
C115	Parallelogram	40%	6	6	N/A	N/A	N/A	N/A	0%	54%	49%	17%	17%	51%	0.97	0.88	1.06	
C116	Parallelogram	27%	6	6	N/A	N/A	N/A	N/A	0%	66%	59%	14%	14%	62%	0.97	0.88	1.06	

Panel Layers			Layers							UV %	Visible Light Transmittance	Total Solar Transmittance	Visible Reflectance		Solar Heat Gain Coefficient	U-Value (BTU/hrft ² F)		Light to Solar Gain
LowIron-LowIronLowE			Class L1	Class L2	Spacer	Class L3	Spacer	Class L4	Exterior				Interior	Winter Nighttime		Summer Daytime		
Panel Type	Shape	Cell Coverage Area	Thickness	Thickness	Size	Thickness	Size	Thickness										
C74	Triangle	47%	3	3	N/A	N/A	N/A	N/A	0%	40%	20%	19%	19%	24%	1.00	0.90	1.69	
C75	Triangle	37%	3	3	N/A	N/A	N/A	N/A	0%	48%	24%	17%	17%	28%	1.00	0.90	1.69	
C76	Triangle	41%	3	3	N/A	N/A	N/A	N/A	0%	45%	22%	18%	18%	26%	1.00	0.90	1.69	
C17	Hexagon	48%	3	3	N/A	N/A	N/A	N/A	0%	39%	20%	20%	19%	23%	1.00	0.90	1.69	
C18	Hexagon	32%	3	3	N/A	N/A	N/A	N/A	0%	52%	26%	16%	16%	31%	1.00	0.90	1.69	
C19	Hexagon	16%	3	3	N/A	N/A	N/A	N/A	0%	64%	32%	13%	12%	38%	1.00	0.90	1.69	
C81	Hexagon	68%	3	3	N/A	N/A	N/A	N/A	0%	24%	12%	24%	23%	14%	1.00	0.90	1.69	
C82	Hexagon	36%	3	3	N/A	N/A	N/A	N/A	0%	48%	24%	17%	17%	29%	1.00	0.90	1.69	
C83	Hexagon	36%	3	3	N/A	N/A	N/A	N/A	0%	48%	24%	17%	17%	29%	1.00	0.90	1.69	
C84	Hexagon	52%	3	3	N/A	N/A	N/A	N/A	0%	36%	18%	20%	20%	21%	1.00	0.90	1.69	
C85	Hexagon	22%	3	3	N/A	N/A	N/A	N/A	0%	60%	30%	14%	14%	35%	1.00	0.90	1.69	
C91	Hexagon	69%	3	3	N/A	N/A	N/A	N/A	0%	24%	12%	24%	23%	14%	1.00	0.90	1.69	
C92	Hexagon	53%	3	3	N/A	N/A	N/A	N/A	0%	36%	18%	21%	20%	21%	1.00	0.90	1.69	
C93	Hexagon	37%	3	3	N/A	N/A	N/A	N/A	0%	48%	24%	17%	17%	28%	1.00	0.90	1.69	
C94	Hexagon	10%	3	3	N/A	N/A	N/A	N/A	0%	69%	34%	12%	11%	41%	1.00	0.90	1.69	
C95	Hexagon	32%	3	3	N/A	N/A	N/A	N/A	0%	52%	26%	16%	16%	31%	1.00	0.90	1.69	
C96	Hexagon	47%	3	3	N/A	N/A	N/A	N/A	0%	40%	20%	19%	19%	24%	1.00	0.90	1.69	
C101	Parallelogram	63%	3	3	N/A	N/A	N/A	N/A	0%	28%	14%	23%	22%	17%	1.00	0.90	1.69	
C102	Parallelogram	30%	3	3	N/A	N/A	N/A	N/A	0%	53%	27%	16%	15%	32%	1.00	0.90	1.69	
C103	Parallelogram	37%	3	3	N/A	N/A	N/A	N/A	0%	48%	24%	17%	17%	29%	1.00	0.90	1.69	
C104	Parallelogram	32%	3	3	N/A	N/A	N/A	N/A	0%	52%	26%	16%	16%	31%	1.00	0.90	1.69	
C105	Parallelogram	23%	3	3	N/A	N/A	N/A	N/A	0%	58%	29%	15%	14%	35%	1.00	0.90	1.69	
C106	Parallelogram	50%	3	3	N/A	N/A	N/A	N/A	0%	38%	19%	20%	19%	23%	1.00	0.90	1.69	
C111	Parallelogram	53%	3	3	N/A	N/A	N/A	N/A	0%	36%	18%	21%	20%	21%	1.00	0.90	1.69	
C112	Parallelogram	40%	3	3	N/A	N/A	N/A	N/A	0%	46%	23%	18%	17%	27%	1.00	0.90	1.69	
C113	Parallelogram	43%	3	3	N/A	N/A	N/A	N/A	0%	43%	22%	19%	18%	26%	1.00	0.90	1.69	
C114	Parallelogram	27%	3	3	N/A	N/A	N/A	N/A	0%	56%	28%	15%	15%	33%	1.00	0.90	1.69	
C115	Parallelogram	40%	3	3	N/A	N/A	N/A	N/A	0%	46%	23%	18%	17%	27%	1.00	0.90	1.69	
C116	Parallelogram	27%	3	3	N/A	N/A	N/A	N/A	0%	56%	28%	15%	15%	33%	1.00	0.90	1.69	

Panel Layers			Layers							UV %	Visible Light Transmittance	Total Solar Transmittance	Visible Reflectance		Solar Heat Gain Coefficient	U-Value (BTU/hrft2F)		Light to Solar Gain
LowIron-LowIronLowE			Class L1	Class L2	Spacer	Class L3	Spacer	Class L4	Exterior				Interior	Winter Nighttime		Summer Daytime		
Panel Type	Shape	Cell Coverage Area	Thickness	Thickness	Size	Thickness	Size	Thickness										
C74	Triangle	47%	4	4	N/A	N/A	N/A	N/A	0%	40%	20%	19%	19%	24%	0.99	0.90	1.69	
C75	Triangle	37%	4	4	N/A	N/A	N/A	N/A	0%	48%	24%	17%	17%	28%	0.99	0.90	1.69	
C76	Triangle	41%	4	4	N/A	N/A	N/A	N/A	0%	45%	22%	18%	18%	26%	0.99	0.90	1.69	
C17	Hexagon	48%	4	4	N/A	N/A	N/A	N/A	0%	39%	20%	20%	19%	23%	0.99	0.90	1.69	
C18	Hexagon	32%	4	4	N/A	N/A	N/A	N/A	0%	52%	26%	16%	16%	31%	0.99	0.90	1.69	
C19	Hexagon	16%	4	4	N/A	N/A	N/A	N/A	0%	64%	32%	13%	12%	38%	0.99	0.90	1.69	
C81	Hexagon	68%	4	4	N/A	N/A	N/A	N/A	0%	24%	12%	24%	23%	14%	0.99	0.90	1.69	
C82	Hexagon	36%	4	4	N/A	N/A	N/A	N/A	0%	48%	24%	17%	17%	29%	0.99	0.90	1.69	
C83	Hexagon	36%	4	4	N/A	N/A	N/A	N/A	0%	48%	24%	17%	17%	29%	0.99	0.90	1.69	
C84	Hexagon	52%	4	4	N/A	N/A	N/A	N/A	0%	36%	18%	20%	20%	21%	0.99	0.90	1.69	
C85	Hexagon	22%	4	4	N/A	N/A	N/A	N/A	0%	60%	30%	14%	14%	35%	0.99	0.90	1.69	
C91	Hexagon	69%	4	4	N/A	N/A	N/A	N/A	0%	24%	12%	24%	23%	14%	0.99	0.90	1.69	
C92	Hexagon	53%	4	4	N/A	N/A	N/A	N/A	0%	36%	18%	21%	20%	21%	0.99	0.90	1.69	
C93	Hexagon	37%	4	4	N/A	N/A	N/A	N/A	0%	48%	24%	17%	17%	28%	0.99	0.90	1.69	
C94	Hexagon	10%	4	4	N/A	N/A	N/A	N/A	0%	69%	34%	12%	11%	41%	0.99	0.90	1.69	
C95	Hexagon	32%	4	4	N/A	N/A	N/A	N/A	0%	52%	26%	16%	16%	31%	0.99	0.90	1.69	
C96	Hexagon	47%	4	4	N/A	N/A	N/A	N/A	0%	40%	20%	19%	19%	24%	0.99	0.90	1.69	
C101	Parallelogram	63%	4	4	N/A	N/A	N/A	N/A	0%	28%	14%	23%	22%	17%	0.99	0.90	1.69	
C102	Parallelogram	30%	4	4	N/A	N/A	N/A	N/A	0%	53%	27%	16%	15%	32%	0.99	0.90	1.69	
C103	Parallelogram	37%	4	4	N/A	N/A	N/A	N/A	0%	48%	24%	17%	17%	29%	0.99	0.90	1.69	
C104	Parallelogram	32%	4	4	N/A	N/A	N/A	N/A	0%	52%	26%	16%	16%	31%	0.99	0.90	1.69	
C105	Parallelogram	23%	4	4	N/A	N/A	N/A	N/A	0%	58%	29%	15%	14%	35%	0.99	0.90	1.69	
C106	Parallelogram	50%	4	4	N/A	N/A	N/A	N/A	0%	38%	19%	20%	19%	23%	0.99	0.90	1.69	
C111	Parallelogram	53%	4	4	N/A	N/A	N/A	N/A	0%	36%	18%	21%	20%	21%	0.99	0.90	1.69	
C112	Parallelogram	40%	4	4	N/A	N/A	N/A	N/A	0%	46%	23%	18%	17%	27%	0.99	0.90	1.69	
C113	Parallelogram	43%	4	4	N/A	N/A	N/A	N/A	0%	43%	22%	19%	18%	26%	0.99	0.90	1.69	
C114	Parallelogram	27%	4	4	N/A	N/A	N/A	N/A	0%	56%	28%	15%	15%	33%	0.99	0.90	1.69	
C115	Parallelogram	40%	4	4	N/A	N/A	N/A	N/A	0%	46%	23%	18%	17%	27%	0.99	0.90	1.69	
C116	Parallelogram	27%	4	4	N/A	N/A	N/A	N/A	0%	56%	28%	15%	15%	33%	0.99	0.90	1.69	

Panel Layers			Layers						UV %	Visible Light Transmittance	Total Solar Transmittance	Visible Reflectance		Solar Heat Gain Coefficient	U-Value (BTU/hrft2F)		Light to Solar Gain
LowIron-LowIronLowE			Class L1	Class L2	Spacer	Class L3	Spacer	Class L4				Exterior	Interior		Winter Nighttime	Summer Daytime	
Panel Type	Shape	Cell Coverage Area	Thickness	Thickness	Size	Thickness	Size	Thickness									
C74	Triangle	47%	6	6	N/A	N/A	N/A	N/A	0%	40%	20%	19%	19%	24%	0.97	0.88	1.65
C75	Triangle	37%	6	6	N/A	N/A	N/A	N/A	0%	48%	24%	17%	17%	29%	0.97	0.88	1.65
C76	Triangle	41%	6	6	N/A	N/A	N/A	N/A	0%	45%	22%	18%	18%	27%	0.97	0.88	1.65
C17	Hexagon	48%	6	6	N/A	N/A	N/A	N/A	0%	39%	20%	20%	19%	24%	0.97	0.88	1.65
C18	Hexagon	32%	6	6	N/A	N/A	N/A	N/A	0%	52%	26%	16%	16%	31%	0.97	0.88	1.65
C19	Hexagon	16%	6	6	N/A	N/A	N/A	N/A	0%	64%	32%	13%	12%	39%	0.97	0.88	1.65
C81	Hexagon	68%	6	6	N/A	N/A	N/A	N/A	0%	24%	12%	24%	23%	15%	0.97	0.88	1.65
C82	Hexagon	36%	6	6	N/A	N/A	N/A	N/A	0%	48%	24%	17%	17%	29%	0.97	0.88	1.65
C83	Hexagon	36%	6	6	N/A	N/A	N/A	N/A	0%	48%	24%	17%	17%	29%	0.97	0.88	1.65
C84	Hexagon	52%	6	6	N/A	N/A	N/A	N/A	0%	36%	18%	20%	20%	22%	0.97	0.88	1.65
C85	Hexagon	22%	6	6	N/A	N/A	N/A	N/A	0%	60%	30%	14%	14%	36%	0.97	0.88	1.65
C91	Hexagon	69%	6	6	N/A	N/A	N/A	N/A	0%	24%	12%	24%	23%	14%	0.97	0.88	1.65
C92	Hexagon	53%	6	6	N/A	N/A	N/A	N/A	0%	36%	18%	21%	20%	22%	0.97	0.88	1.65
C93	Hexagon	37%	6	6	N/A	N/A	N/A	N/A	0%	48%	24%	17%	17%	29%	0.97	0.88	1.65
C94	Hexagon	10%	6	6	N/A	N/A	N/A	N/A	0%	69%	34%	12%	11%	41%	0.97	0.88	1.65
C95	Hexagon	32%	6	6	N/A	N/A	N/A	N/A	0%	52%	26%	16%	16%	31%	0.97	0.88	1.65
C96	Hexagon	47%	6	6	N/A	N/A	N/A	N/A	0%	40%	20%	19%	19%	24%	0.97	0.88	1.65
C101	Parallelogram	63%	6	6	N/A	N/A	N/A	N/A	0%	28%	14%	23%	22%	17%	0.97	0.88	1.65
C102	Parallelogram	30%	6	6	N/A	N/A	N/A	N/A	0%	53%	27%	16%	15%	32%	0.97	0.88	1.65
C103	Parallelogram	37%	6	6	N/A	N/A	N/A	N/A	0%	48%	24%	17%	17%	29%	0.97	0.88	1.65
C104	Parallelogram	32%	6	6	N/A	N/A	N/A	N/A	0%	52%	26%	16%	16%	31%	0.97	0.88	1.65
C105	Parallelogram	23%	6	6	N/A	N/A	N/A	N/A	0%	58%	29%	15%	14%	35%	0.97	0.88	1.65
C106	Parallelogram	50%	6	6	N/A	N/A	N/A	N/A	0%	38%	19%	20%	19%	23%	0.97	0.88	1.65
C111	Parallelogram	53%	6	6	N/A	N/A	N/A	N/A	0%	36%	18%	21%	20%	22%	0.97	0.88	1.65
C112	Parallelogram	40%	6	6	N/A	N/A	N/A	N/A	0%	46%	23%	18%	17%	28%	0.97	0.88	1.65
C113	Parallelogram	43%	6	6	N/A	N/A	N/A	N/A	0%	43%	22%	19%	18%	26%	0.97	0.88	1.65
C114	Parallelogram	27%	6	6	N/A	N/A	N/A	N/A	0%	56%	28%	15%	15%	34%	0.97	0.88	1.65
C115	Parallelogram	40%	6	6	N/A	N/A	N/A	N/A	0%	46%	23%	18%	17%	28%	0.97	0.88	1.65
C116	Parallelogram	27%	6	6	N/A	N/A	N/A	N/A	0%	56%	28%	15%	15%	34%	0.97	0.88	1.65

Panel Layers			Layers							UV %	Visible Light Transmittance	Total Solar Transmittance	Visible Reflectance		Solar Heat Gain Coefficient	U-Value (BTU/hrft2F)		Light to Solar Gain
LowIron-LowIron-Spacer-Clear			Class L1 Thickness	Class L2 Thickness	Spacer Size	Class L3 Thickness	Spacer Size	Class L4 Thickness	Exterior				Interior	Winter Nighttime		Summer Daytime		
Panel Type	Shape	Cell Coverage Area																
C74	Triangle	47%	3	3	12	3	N/A	N/A	0%	43%	37%	22%	22%	40%	0.45	0.47	1.08	
C75	Triangle	37%	3	3	12	3	N/A	N/A	0%	52%	44%	21%	21%	48%	0.45	0.47	1.08	
C76	Triangle	41%	3	3	12	3	N/A	N/A	0%	48%	41%	21%	21%	45%	0.45	0.47	1.08	
C17	Hexagon	48%	3	3	12	3	N/A	N/A	0%	42%	36%	22%	22%	39%	0.45	0.47	1.08	
C18	Hexagon	32%	3	3	12	3	N/A	N/A	0%	56%	47%	20%	20%	52%	0.45	0.47	1.08	
C19	Hexagon	16%	3	3	12	3	N/A	N/A	0%	69%	59%	17%	17%	64%	0.45	0.47	1.08	
C81	Hexagon	68%	3	3	12	3	N/A	N/A	0%	26%	22%	25%	25%	24%	0.45	0.47	1.08	
C82	Hexagon	36%	3	3	12	3	N/A	N/A	0%	52%	44%	20%	20%	48%	0.45	0.47	1.08	
C83	Hexagon	36%	3	3	12	3	N/A	N/A	0%	52%	44%	20%	20%	48%	0.45	0.47	1.08	
C84	Hexagon	52%	3	3	12	3	N/A	N/A	0%	39%	33%	23%	23%	36%	0.45	0.47	1.08	
C85	Hexagon	22%	3	3	12	3	N/A	N/A	0%	64%	55%	18%	18%	60%	0.45	0.47	1.08	
C91	Hexagon	69%	3	3	12	3	N/A	N/A	0%	25%	22%	25%	25%	24%	0.45	0.47	1.08	
C92	Hexagon	53%	3	3	12	3	N/A	N/A	0%	38%	33%	23%	23%	36%	0.45	0.47	1.08	
C93	Hexagon	37%	3	3	12	3	N/A	N/A	0%	51%	44%	21%	21%	48%	0.45	0.47	1.08	
C94	Hexagon	10%	3	3	12	3	N/A	N/A	0%	74%	63%	16%	16%	69%	0.45	0.47	1.08	
C95	Hexagon	32%	3	3	12	3	N/A	N/A	0%	56%	48%	20%	20%	52%	0.45	0.47	1.08	
C96	Hexagon	47%	3	3	12	3	N/A	N/A	0%	43%	37%	22%	22%	40%	0.45	0.47	1.08	
C101	Parallelogram	63%	3	3	12	3	N/A	N/A	0%	30%	26%	24%	24%	28%	0.45	0.47	1.08	
C102	Parallelogram	30%	3	3	12	3	N/A	N/A	0%	57%	49%	19%	19%	53%	0.45	0.47	1.08	
C103	Parallelogram	37%	3	3	12	3	N/A	N/A	0%	52%	44%	20%	20%	48%	0.45	0.47	1.08	
C104	Parallelogram	32%	3	3	12	3	N/A	N/A	0%	56%	48%	20%	20%	52%	0.45	0.47	1.08	
C105	Parallelogram	23%	3	3	12	3	N/A	N/A	0%	63%	54%	18%	18%	58%	0.45	0.47	1.08	
C106	Parallelogram	50%	3	3	12	3	N/A	N/A	0%	41%	35%	22%	22%	38%	0.45	0.47	1.08	
C111	Parallelogram	53%	3	3	12	3	N/A	N/A	0%	38%	33%	23%	23%	36%	0.45	0.47	1.08	
C112	Parallelogram	40%	3	3	12	3	N/A	N/A	0%	49%	42%	21%	21%	46%	0.45	0.47	1.08	
C113	Parallelogram	43%	3	3	12	3	N/A	N/A	0%	47%	40%	21%	21%	43%	0.45	0.47	1.08	
C114	Parallelogram	27%	3	3	12	3	N/A	N/A	0%	60%	51%	19%	19%	56%	0.45	0.47	1.08	
C115	Parallelogram	40%	3	3	12	3	N/A	N/A	0%	49%	42%	21%	21%	46%	0.45	0.47	1.08	
C116	Parallelogram	27%	3	3	12	3	N/A	N/A	0%	60%	51%	19%	19%	56%	0.45	0.47	1.08	

Panel Layers			Layers							UV %	Visible Light Transmittance	Total Solar Transmittance	Visible Reflectance		Solar Heat Gain Coefficient	U-Value (BTU/hrft2F)		Light to Solar Gain
LowIron-LowIron-Spacer-Clear			Class L1	Class L2	Spacer	Class L3	Spacer	Class L4	Exterior				Interior	Winter Nighttime		Summer Daytime		
Panel Type	Shape	Cell Coverage Area	Thickness	Thickness	Size	Thickness	Size	Thickness										
C74	Triangle	47%	4	4	12	4	N/A	N/A	1%	43%	36%	22%	22%	40%	0.44	0.47	1.09	
C75	Triangle	37%	4	4	12	4	N/A	N/A	1%	52%	43%	21%	21%	47%	0.44	0.47	1.09	
C76	Triangle	41%	4	4	12	4	N/A	N/A	1%	48%	40%	21%	21%	44%	0.44	0.47	1.09	
C17	Hexagon	48%	4	4	12	4	N/A	N/A	1%	42%	35%	22%	22%	39%	0.44	0.47	1.09	
C18	Hexagon	32%	4	4	12	4	N/A	N/A	1%	56%	46%	20%	20%	51%	0.44	0.47	1.09	
C19	Hexagon	16%	4	4	12	4	N/A	N/A	1%	69%	57%	17%	17%	63%	0.44	0.47	1.09	
C81	Hexagon	68%	4	4	12	4	N/A	N/A	0%	26%	22%	25%	25%	24%	0.44	0.47	1.09	
C82	Hexagon	36%	4	4	12	4	N/A	N/A	1%	52%	43%	20%	20%	48%	0.44	0.47	1.09	
C83	Hexagon	36%	4	4	12	4	N/A	N/A	1%	52%	43%	20%	20%	48%	0.44	0.47	1.09	
C84	Hexagon	52%	4	4	12	4	N/A	N/A	0%	39%	32%	23%	23%	36%	0.44	0.47	1.09	
C85	Hexagon	22%	4	4	12	4	N/A	N/A	1%	64%	53%	18%	18%	59%	0.44	0.47	1.09	
C91	Hexagon	69%	4	4	12	4	N/A	N/A	0%	25%	21%	25%	25%	23%	0.44	0.47	1.09	
C92	Hexagon	53%	4	4	12	4	N/A	N/A	0%	38%	32%	23%	23%	35%	0.44	0.47	1.09	
C93	Hexagon	37%	4	4	12	4	N/A	N/A	1%	51%	43%	21%	21%	47%	0.44	0.47	1.09	
C94	Hexagon	10%	4	4	12	4	N/A	N/A	1%	74%	61%	16%	16%	68%	0.44	0.47	1.09	
C95	Hexagon	32%	4	4	12	4	N/A	N/A	1%	56%	47%	20%	20%	51%	0.44	0.47	1.09	
C96	Hexagon	47%	4	4	12	4	N/A	N/A	1%	43%	36%	22%	22%	40%	0.44	0.47	1.09	
C101	Parallelogram	63%	4	4	12	4	N/A	N/A	0%	30%	25%	24%	24%	28%	0.44	0.47	1.09	
C102	Parallelogram	30%	4	4	12	4	N/A	N/A	1%	57%	48%	19%	19%	53%	0.44	0.47	1.09	
C103	Parallelogram	37%	4	4	12	4	N/A	N/A	1%	52%	43%	20%	20%	48%	0.44	0.47	1.09	
C104	Parallelogram	32%	4	4	12	4	N/A	N/A	1%	56%	47%	20%	20%	51%	0.44	0.47	1.09	
C105	Parallelogram	23%	4	4	12	4	N/A	N/A	1%	63%	52%	18%	18%	58%	0.44	0.47	1.09	
C106	Parallelogram	50%	4	4	12	4	N/A	N/A	1%	41%	34%	22%	22%	38%	0.44	0.47	1.09	
C111	Parallelogram	53%	4	4	12	4	N/A	N/A	0%	38%	32%	23%	23%	35%	0.44	0.47	1.09	
C112	Parallelogram	40%	4	4	12	4	N/A	N/A	1%	49%	41%	21%	21%	45%	0.44	0.47	1.09	
C113	Parallelogram	43%	4	4	12	4	N/A	N/A	1%	47%	39%	21%	21%	43%	0.44	0.47	1.09	
C114	Parallelogram	27%	4	4	12	4	N/A	N/A	1%	60%	50%	19%	19%	55%	0.44	0.47	1.09	
C115	Parallelogram	40%	4	4	12	4	N/A	N/A	1%	49%	41%	21%	21%	45%	0.44	0.47	1.09	
C116	Parallelogram	27%	4	4	12	4	N/A	N/A	1%	60%	50%	19%	19%	55%	0.44	0.47	1.09	

Panel Layers			Layers						UV %	Visible Light Transmittance	Total Solar Transmittance	Visible Reflectance		Solar Heat Gain Coefficient	U-Value (BTU/hrft2F)		Light to Solar Gain
LowIron-LowIron-Spacer-Clear			Class L1 Thickness	Class L2 Thickness	Spacer Size	Class L3 Thickness	Spacer Size	Class L4 Thickness				Exterior	Interior		Winter Nighttime	Summer Daytime	
Panel Type	Shape	Cell Coverage Area															
C74	Triangle	47%	6	6	12	6	N/A	N/A	0%	43%	33%	22%	22%	38%	0.44	0.46	1.11
C75	Triangle	37%	6	6	12	6	N/A	N/A	0%	51%	40%	21%	21%	46%	0.44	0.46	1.11
C76	Triangle	41%	6	6	12	6	N/A	N/A	0%	47%	37%	21%	21%	43%	0.44	0.46	1.11
C17	Hexagon	48%	6	6	12	6	N/A	N/A	0%	42%	33%	22%	22%	38%	0.44	0.46	1.11
C18	Hexagon	32%	6	6	12	6	N/A	N/A	0%	58%	43%	20%	20%	50%	0.44	0.46	1.11
C19	Hexagon	16%	6	6	12	6	N/A	N/A	0%	68%	53%	17%	17%	61%	0.44	0.46	1.11
C81	Hexagon	68%	6	6	12	6	N/A	N/A	0%	26%	20%	25%	25%	23%	0.44	0.46	1.11
C82	Hexagon	36%	6	6	12	6	N/A	N/A	0%	51%	40%	20%	20%	46%	0.44	0.46	1.11
C83	Hexagon	36%	6	6	12	6	N/A	N/A	0%	51%	40%	20%	20%	46%	0.44	0.46	1.11
C84	Hexagon	52%	6	6	12	6	N/A	N/A	0%	39%	30%	23%	23%	35%	0.44	0.46	1.11
C85	Hexagon	22%	6	6	12	6	N/A	N/A	0%	63%	49%	18%	18%	57%	0.44	0.46	1.11
C91	Hexagon	69%	6	6	12	6	N/A	N/A	0%	25%	20%	25%	25%	23%	0.44	0.46	1.11
C92	Hexagon	53%	6	6	12	6	N/A	N/A	0%	38%	29%	23%	23%	34%	0.44	0.46	1.11
C93	Hexagon	37%	6	6	12	6	N/A	N/A	0%	51%	39%	21%	21%	46%	0.44	0.46	1.11
C94	Hexagon	10%	6	6	12	6	N/A	N/A	0%	73%	57%	16%	16%	66%	0.44	0.46	1.11
C95	Hexagon	32%	6	6	12	6	N/A	N/A	0%	55%	43%	20%	20%	50%	0.44	0.46	1.11
C96	Hexagon	47%	6	6	12	6	N/A	N/A	0%	43%	33%	22%	22%	38%	0.44	0.46	1.11
C101	Parallelogram	63%	6	6	12	6	N/A	N/A	0%	30%	23%	24%	24%	27%	0.44	0.46	1.11
C102	Parallelogram	30%	6	6	12	6	N/A	N/A	0%	57%	44%	19%	19%	51%	0.44	0.46	1.11
C103	Parallelogram	37%	6	6	12	6	N/A	N/A	0%	51%	40%	20%	20%	46%	0.44	0.46	1.11
C104	Parallelogram	32%	6	6	12	6	N/A	N/A	0%	55%	43%	20%	20%	50%	0.44	0.46	1.11
C105	Parallelogram	23%	6	6	12	6	N/A	N/A	0%	62%	48%	18%	18%	56%	0.44	0.46	1.11
C106	Parallelogram	50%	6	6	12	6	N/A	N/A	0%	41%	32%	22%	22%	37%	0.44	0.46	1.11
C111	Parallelogram	53%	6	6	12	6	N/A	N/A	0%	38%	29%	23%	23%	34%	0.44	0.46	1.11
C112	Parallelogram	40%	6	6	12	6	N/A	N/A	0%	49%	38%	21%	21%	44%	0.44	0.46	1.11
C113	Parallelogram	43%	6	6	12	6	N/A	N/A	0%	46%	36%	21%	21%	41%	0.44	0.46	1.11
C114	Parallelogram	27%	6	6	12	6	N/A	N/A	0%	59%	46%	19%	19%	54%	0.44	0.46	1.11
C115	Parallelogram	40%	6	6	12	6	N/A	N/A	0%	49%	38%	21%	21%	44%	0.44	0.46	1.11
C116	Parallelogram	27%	6	6	12	6	N/A	N/A	0%	59%	46%	19%	19%	54%	0.44	0.46	1.11

Panel Layers			Layers							UV %	Visible Light Transmittance	Total Solar Transmittance	Visible Reflectance		Solar Heat Gain Coefficient	U-Value (BTU/hrft2F)		Light to Solar Gain
LowIron-LowIron-Spacer-LowIron			Class L1 Thickness	Class L2 Thickness	Spacer Size	Class L3 Thickness	Spacer Size	Class L4 Thickness	Exterior				Interior	Winter Nighttime		Summer Daytime		
Panel Type	Shape	Cell Coverage Area																
C74	Triangle	47%	3	3	12	3	N/A	N/A	0%	44%	40%	22%	22%	41%	0.45	0.47	1.08	
C75	Triangle	37%	3	3	12	3	N/A	N/A	0%	53%	48%	21%	21%	49%	0.45	0.47	1.08	
C76	Triangle	41%	3	3	12	3	N/A	N/A	0%	49%	45%	21%	21%	46%	0.45	0.47	1.08	
C17	Hexagon	48%	3	3	12	3	N/A	N/A	0%	43%	39%	22%	22%	40%	0.45	0.47	1.08	
C18	Hexagon	32%	3	3	12	3	N/A	N/A	0%	57%	52%	20%	20%	53%	0.45	0.47	1.08	
C19	Hexagon	16%	3	3	12	3	N/A	N/A	0%	70%	64%	17%	17%	65%	0.45	0.47	1.08	
C81	Hexagon	68%	3	3	12	3	N/A	N/A	0%	27%	24%	25%	25%	25%	0.45	0.47	1.08	
C82	Hexagon	36%	3	3	12	3	N/A	N/A	0%	53%	48%	20%	20%	50%	0.45	0.47	1.08	
C83	Hexagon	36%	3	3	12	3	N/A	N/A	0%	53%	48%	20%	20%	50%	0.45	0.47	1.08	
C84	Hexagon	52%	3	3	12	3	N/A	N/A	0%	40%	36%	23%	23%	37%	0.45	0.47	1.08	
C85	Hexagon	22%	3	3	12	3	N/A	N/A	0%	66%	60%	18%	18%	61%	0.45	0.47	1.08	
C91	Hexagon	69%	3	3	12	3	N/A	N/A	0%	26%	24%	25%	25%	24%	0.45	0.47	1.08	
C92	Hexagon	53%	3	3	12	3	N/A	N/A	0%	39%	36%	23%	23%	36%	0.45	0.47	1.08	
C93	Hexagon	37%	3	3	12	3	N/A	N/A	0%	53%	48%	21%	21%	49%	0.45	0.47	1.08	
C94	Hexagon	10%	3	3	12	3	N/A	N/A	0%	76%	69%	16%	16%	70%	0.45	0.47	1.08	
C95	Hexagon	32%	3	3	12	3	N/A	N/A	0%	58%	52%	20%	20%	53%	0.45	0.47	1.08	
C96	Hexagon	47%	3	3	12	3	N/A	N/A	0%	44%	40%	22%	22%	41%	0.45	0.47	1.08	
C101	Parallelogram	63%	3	3	12	3	N/A	N/A	0%	31%	28%	24%	24%	29%	0.45	0.47	1.08	
C102	Parallelogram	30%	3	3	12	3	N/A	N/A	0%	59%	53%	19%	19%	55%	0.45	0.47	1.08	
C103	Parallelogram	37%	3	3	12	3	N/A	N/A	0%	53%	48%	20%	20%	49%	0.45	0.47	1.08	
C104	Parallelogram	32%	3	3	12	3	N/A	N/A	0%	57%	52%	20%	20%	53%	0.45	0.47	1.08	
C105	Parallelogram	23%	3	3	12	3	N/A	N/A	0%	64%	58%	18%	18%	60%	0.45	0.47	1.08	
C106	Parallelogram	50%	3	3	12	3	N/A	N/A	0%	42%	38%	22%	22%	39%	0.45	0.47	1.08	
C111	Parallelogram	53%	3	3	12	3	N/A	N/A	0%	39%	36%	23%	23%	36%	0.45	0.47	1.08	
C112	Parallelogram	40%	3	3	12	3	N/A	N/A	0%	50%	46%	21%	21%	47%	0.45	0.47	1.08	
C113	Parallelogram	43%	3	3	12	3	N/A	N/A	0%	48%	43%	21%	21%	44%	0.45	0.47	1.08	
C114	Parallelogram	27%	3	3	12	3	N/A	N/A	0%	62%	56%	19%	19%	57%	0.45	0.47	1.08	
C115	Parallelogram	40%	3	3	12	3	N/A	N/A	0%	50%	46%	21%	21%	47%	0.45	0.47	1.08	
C116	Parallelogram	27%	3	3	12	3	N/A	N/A	0%	62%	56%	19%	19%	57%	0.45	0.47	1.08	

Panel Layers			Layers							UV %	Visible Light Transmittance	Total Solar Transmittance	Visible Reflectance		Solar Heat Gain Coefficient	U-Value (BTU/hrft2F)		Light to Solar Gain
LowIron-LowIron-Spacer-LowIron			Class L1 Thickness	Class L2 Thickness	Spacer Size	Class L3 Thickness	Spacer Size	Class L4 Thickness	Exterior				Interior	Winter Nighttime		Summer Daytime		
Panel Type	Shape	Cell Coverage Area																
C74	Triangle	47%	4	4	12	4	N/A	N/A	1%	44%	40%	22%	22%	41%	0.44	0.47	1.08	
C75	Triangle	37%	4	4	12	4	N/A	N/A	1%	52%	47%	21%	21%	49%	0.44	0.47	1.08	
C76	Triangle	41%	4	4	12	4	N/A	N/A	1%	49%	44%	21%	21%	45%	0.44	0.47	1.08	
C17	Hexagon	48%	4	4	12	4	N/A	N/A	1%	43%	39%	22%	22%	40%	0.44	0.47	1.08	
C18	Hexagon	32%	4	4	12	4	N/A	N/A	1%	56%	51%	20%	20%	52%	0.44	0.47	1.08	
C19	Hexagon	16%	4	4	12	4	N/A	N/A	1%	70%	63%	17%	17%	65%	0.44	0.47	1.08	
C81	Hexagon	68%	4	4	12	4	N/A	N/A	0%	27%	24%	25%	25%	25%	0.44	0.47	1.08	
C82	Hexagon	36%	4	4	12	4	N/A	N/A	1%	53%	48%	20%	20%	49%	0.44	0.47	1.08	
C83	Hexagon	36%	4	4	12	4	N/A	N/A	1%	53%	48%	20%	20%	49%	0.44	0.47	1.08	
C84	Hexagon	52%	4	4	12	4	N/A	N/A	0%	40%	36%	23%	23%	37%	0.44	0.47	1.08	
C85	Hexagon	22%	4	4	12	4	N/A	N/A	1%	65%	59%	18%	18%	60%	0.44	0.47	1.08	
C91	Hexagon	69%	4	4	12	4	N/A	N/A	0%	26%	23%	25%	25%	24%	0.44	0.47	1.08	
C92	Hexagon	53%	4	4	12	4	N/A	N/A	0%	39%	35%	23%	23%	36%	0.44	0.47	1.08	
C93	Hexagon	37%	4	4	12	4	N/A	N/A	1%	52%	47%	21%	21%	48%	0.44	0.47	1.08	
C94	Hexagon	10%	4	4	12	4	N/A	N/A	1%	75%	68%	16%	16%	69%	0.44	0.47	1.08	
C95	Hexagon	32%	4	4	12	4	N/A	N/A	1%	57%	51%	20%	20%	53%	0.44	0.47	1.08	
C96	Hexagon	47%	4	4	12	4	N/A	N/A	1%	44%	40%	22%	22%	41%	0.44	0.47	1.08	
C101	Parallelogram	63%	4	4	12	4	N/A	N/A	0%	31%	28%	24%	24%	28%	0.44	0.47	1.08	
C102	Parallelogram	30%	4	4	12	4	N/A	N/A	1%	58%	53%	19%	19%	54%	0.44	0.47	1.08	
C103	Parallelogram	37%	4	4	12	4	N/A	N/A	1%	53%	48%	20%	20%	49%	0.44	0.47	1.08	
C104	Parallelogram	32%	4	4	12	4	N/A	N/A	1%	57%	51%	20%	20%	53%	0.44	0.47	1.08	
C105	Parallelogram	23%	4	4	12	4	N/A	N/A	1%	64%	58%	18%	18%	59%	0.44	0.47	1.08	
C106	Parallelogram	50%	4	4	12	4	N/A	N/A	1%	42%	38%	22%	22%	39%	0.44	0.47	1.08	
C111	Parallelogram	53%	4	4	12	4	N/A	N/A	0%	39%	35%	23%	23%	36%	0.44	0.47	1.08	
C112	Parallelogram	40%	4	4	12	4	N/A	N/A	1%	50%	45%	21%	21%	46%	0.44	0.47	1.08	
C113	Parallelogram	43%	4	4	12	4	N/A	N/A	1%	47%	43%	21%	21%	44%	0.44	0.47	1.08	
C114	Parallelogram	27%	4	4	12	4	N/A	N/A	1%	61%	55%	19%	19%	57%	0.44	0.47	1.08	
C115	Parallelogram	40%	4	4	12	4	N/A	N/A	1%	50%	45%	21%	21%	46%	0.44	0.47	1.08	
C116	Parallelogram	27%	4	4	12	4	N/A	N/A	1%	61%	55%	19%	19%	57%	0.44	0.47	1.08	

Panel Layers			Layers							UV %	Visible Light Transmittance	Total Solar Transmittance	Visible Reflectance		Solar Heat Gain Coefficient	U-Value (BTU/hrft2F)		Light to Solar Gain
LowIron-LowIron-Spacer-LowIron			Glass L1 Thickness	Glass L2 Thickness	Spacer Size	Glass L3 Thickness	Spacer Size	Glass L4 Thickness	Exterior				Interior	Winter Nighttime		Summer Daytime		
Panel Type	Shape	Cell Coverage Area																
C74	Triangle	47%	6	6	12	6	N/A	N/A	0%	44%	38%	22%	22%	40%	0.44	0.46	1.09	
C75	Triangle	37%	6	6	12	6	N/A	N/A	0%	52%	46%	21%	21%	48%	0.44	0.46	1.09	
C76	Triangle	41%	6	6	12	6	N/A	N/A	0%	49%	43%	21%	21%	45%	0.44	0.46	1.09	
C17	Hexagon	48%	6	6	12	6	N/A	N/A	0%	43%	38%	22%	22%	39%	0.44	0.46	1.09	
C18	Hexagon	32%	6	6	12	6	N/A	N/A	0%	56%	50%	20%	20%	52%	0.44	0.46	1.09	
C19	Hexagon	16%	6	6	12	6	N/A	N/A	0%	70%	61%	17%	17%	64%	0.44	0.46	1.09	
C81	Hexagon	68%	6	6	12	6	N/A	N/A	0%	27%	23%	25%	25%	24%	0.44	0.46	1.09	
C82	Hexagon	36%	6	6	12	6	N/A	N/A	0%	53%	46%	20%	20%	48%	0.44	0.46	1.09	
C83	Hexagon	36%	6	6	12	6	N/A	N/A	0%	53%	46%	20%	20%	48%	0.44	0.46	1.09	
C84	Hexagon	52%	6	6	12	6	N/A	N/A	0%	40%	35%	23%	23%	36%	0.44	0.46	1.09	
C85	Hexagon	22%	6	6	12	6	N/A	N/A	0%	65%	57%	18%	18%	60%	0.44	0.46	1.09	
C91	Hexagon	69%	6	6	12	6	N/A	N/A	0%	26%	23%	25%	25%	24%	0.44	0.46	1.09	
C92	Hexagon	53%	6	6	12	6	N/A	N/A	0%	39%	34%	23%	23%	36%	0.44	0.46	1.09	
C93	Hexagon	37%	6	6	12	6	N/A	N/A	0%	52%	46%	21%	21%	48%	0.44	0.46	1.09	
C94	Hexagon	10%	6	6	12	6	N/A	N/A	0%	75%	66%	16%	16%	69%	0.44	0.46	1.09	
C95	Hexagon	32%	6	6	12	6	N/A	N/A	0%	57%	50%	20%	20%	52%	0.44	0.46	1.09	
C96	Hexagon	47%	6	6	12	6	N/A	N/A	0%	44%	38%	22%	22%	40%	0.44	0.46	1.09	
C101	Parallelogram	63%	6	6	12	6	N/A	N/A	0%	31%	27%	24%	24%	28%	0.44	0.46	1.09	
C102	Parallelogram	30%	6	6	12	6	N/A	N/A	0%	58%	51%	19%	19%	53%	0.44	0.46	1.09	
C103	Parallelogram	37%	6	6	12	6	N/A	N/A	0%	53%	46%	20%	20%	48%	0.44	0.46	1.09	
C104	Parallelogram	32%	6	6	12	6	N/A	N/A	0%	57%	50%	20%	20%	52%	0.44	0.46	1.09	
C105	Parallelogram	23%	6	6	12	6	N/A	N/A	0%	64%	56%	18%	18%	58%	0.44	0.46	1.09	
C106	Parallelogram	50%	6	6	12	6	N/A	N/A	0%	42%	37%	22%	22%	38%	0.44	0.46	1.09	
C111	Parallelogram	53%	6	6	12	6	N/A	N/A	0%	39%	34%	23%	23%	36%	0.44	0.46	1.09	
C112	Parallelogram	40%	6	6	12	6	N/A	N/A	0%	50%	44%	21%	21%	46%	0.44	0.46	1.09	
C113	Parallelogram	43%	6	6	12	6	N/A	N/A	0%	47%	41%	21%	21%	43%	0.44	0.46	1.09	
C114	Parallelogram	27%	6	6	12	6	N/A	N/A	0%	61%	54%	19%	19%	56%	0.44	0.46	1.09	
C115	Parallelogram	40%	6	6	12	6	N/A	N/A	0%	50%	44%	21%	21%	46%	0.44	0.46	1.09	
C116	Parallelogram	27%	6	6	12	6	N/A	N/A	0%	61%	54%	19%	19%	56%	0.44	0.46	1.09	

Panel Layers			Layers						UV %	Visible Light Transmittance	Total Solar Transmittance	Visible Reflectance		Solar Heat Gain Coefficient	U-Value (BTU/hrft2F)		Light to Solar Gain
Panel Type	Shape	Cell Coverage Area	Glass L1 Thickness	Glass L2 Thickness	Spacer Size	Glass L3 Thickness	Spacer Size	Glass L4 Thickness				Exterior	Interior		Winter Nighttime	Summer Daytime	
C74	Triangle	47%	3	3	12	3	N/A	N/A	0%	38%	19%	21%	20%	25%	0.24	0.22	1.52
C75	Triangle	37%	3	3	12	3	N/A	N/A	0%	46%	23%	19%	18%	30%	0.24	0.22	1.52
C76	Triangle	41%	3	3	12	3	N/A	N/A	0%	43%	22%	19%	19%	28%	0.24	0.22	1.52
C17	Hexagon	48%	3	3	12	3	N/A	N/A	0%	38%	19%	21%	20%	25%	0.24	0.22	1.52
C18	Hexagon	32%	3	3	12	3	N/A	N/A	0%	50%	25%	18%	17%	33%	0.24	0.22	1.52
C19	Hexagon	16%	3	3	12	3	N/A	N/A	0%	61%	31%	15%	14%	40%	0.24	0.22	1.52
C81	Hexagon	68%	3	3	12	3	N/A	N/A	0%	23%	12%	24%	24%	15%	0.24	0.22	1.52
C82	Hexagon	36%	3	3	12	3	N/A	N/A	0%	46%	24%	19%	18%	31%	0.24	0.22	1.52
C83	Hexagon	36%	3	3	12	3	N/A	N/A	0%	46%	24%	19%	18%	31%	0.24	0.22	1.52
C84	Hexagon	52%	3	3	12	3	N/A	N/A	0%	35%	18%	21%	21%	23%	0.24	0.22	1.52
C85	Hexagon	22%	3	3	12	3	N/A	N/A	0%	57%	29%	16%	15%	38%	0.24	0.22	1.52
C91	Hexagon	69%	3	3	12	3	N/A	N/A	0%	23%	11%	24%	24%	15%	0.24	0.22	1.52
C92	Hexagon	53%	3	3	12	3	N/A	N/A	0%	34%	17%	22%	21%	22%	0.24	0.22	1.52
C93	Hexagon	37%	3	3	12	3	N/A	N/A	0%	46%	23%	19%	18%	30%	0.24	0.22	1.52
C94	Hexagon	10%	3	3	12	3	N/A	N/A	0%	66%	33%	14%	13%	43%	0.24	0.22	1.52
C95	Hexagon	32%	3	3	12	3	N/A	N/A	0%	50%	25%	18%	17%	33%	0.24	0.22	1.52
C96	Hexagon	47%	3	3	12	3	N/A	N/A	0%	38%	20%	21%	20%	25%	0.24	0.22	1.52
C101	Parallelogram	63%	3	3	12	3	N/A	N/A	0%	27%	14%	23%	23%	18%	0.24	0.22	1.52
C102	Parallelogram	30%	3	3	12	3	N/A	N/A	0%	51%	26%	17%	17%	34%	0.24	0.22	1.52
C103	Parallelogram	37%	3	3	12	3	N/A	N/A	0%	46%	23%	19%	18%	30%	0.24	0.22	1.52
C104	Parallelogram	32%	3	3	12	3	N/A	N/A	0%	50%	25%	18%	17%	33%	0.24	0.22	1.52
C105	Parallelogram	23%	3	3	12	3	N/A	N/A	0%	56%	28%	16%	15%	37%	0.24	0.22	1.52
C106	Parallelogram	50%	3	3	12	3	N/A	N/A	0%	37%	19%	21%	20%	24%	0.24	0.22	1.52
C111	Parallelogram	53%	3	3	12	3	N/A	N/A	0%	34%	17%	22%	21%	22%	0.24	0.22	1.52
C112	Parallelogram	40%	3	3	12	3	N/A	N/A	0%	44%	22%	19%	19%	29%	0.24	0.22	1.52
C113	Parallelogram	43%	3	3	12	3	N/A	N/A	0%	41%	21%	20%	19%	27%	0.24	0.22	1.52
C114	Parallelogram	27%	3	3	12	3	N/A	N/A	0%	54%	27%	17%	16%	35%	0.24	0.22	1.52
C115	Parallelogram	40%	3	3	12	3	N/A	N/A	0%	44%	22%	19%	19%	29%	0.24	0.22	1.52
C116	Parallelogram	27%	3	3	12	3	N/A	N/A	0%	54%	27%	17%	16%	35%	0.24	0.22	1.52

Panel Layers			Layers							UV %	Visible Light Transmittance	Total Solar Transmittance	Visible Reflectance		Solar Heat Gain Coefficient	U-Value (BTU/hrft2F)		Light to Solar Gain
Panel Type	Shape	Cell Coverage Area	Glass L1 Thickness	Glass L2 Thickness	Spacer Size	Glass L3 Thickness	Spacer Size	Glass L4 Thickness	Exterior				Interior	Winter Nighttime		Summer Daytime		
C74	Triangle	47%	4	4	12	4	N/A	N/A	0%	38%	19%	21%	20%	25%	0.24	0.22	1.52	
C75	Triangle	37%	4	4	12	4	N/A	N/A	0%	46%	23%	19%	18%	30%	0.24	0.22	1.52	
C76	Triangle	41%	4	4	12	4	N/A	N/A	0%	43%	21%	19%	19%	28%	0.24	0.22	1.52	
C17	Hexagon	48%	4	4	12	4	N/A	N/A	0%	38%	19%	21%	20%	25%	0.24	0.22	1.52	
C18	Hexagon	32%	4	4	12	4	N/A	N/A	0%	50%	24%	18%	17%	33%	0.24	0.22	1.52	
C19	Hexagon	16%	4	4	12	4	N/A	N/A	0%	61%	30%	15%	14%	40%	0.24	0.22	1.52	
C81	Hexagon	68%	4	4	12	4	N/A	N/A	0%	23%	12%	24%	24%	15%	0.24	0.22	1.52	
C82	Hexagon	36%	4	4	12	4	N/A	N/A	0%	46%	23%	19%	18%	31%	0.24	0.22	1.52	
C83	Hexagon	36%	4	4	12	4	N/A	N/A	0%	46%	23%	19%	18%	31%	0.24	0.22	1.52	
C84	Hexagon	52%	4	4	12	4	N/A	N/A	0%	35%	17%	21%	21%	23%	0.24	0.22	1.52	
C85	Hexagon	22%	4	4	12	4	N/A	N/A	0%	57%	28%	16%	15%	38%	0.24	0.22	1.52	
C91	Hexagon	69%	4	4	12	4	N/A	N/A	0%	23%	11%	24%	24%	15%	0.24	0.22	1.52	
C92	Hexagon	53%	4	4	12	4	N/A	N/A	0%	34%	17%	22%	21%	22%	0.24	0.22	1.52	
C93	Hexagon	37%	4	4	12	4	N/A	N/A	0%	46%	23%	19%	18%	30%	0.24	0.22	1.52	
C94	Hexagon	10%	4	4	12	4	N/A	N/A	0%	66%	32%	14%	13%	43%	0.24	0.22	1.52	
C95	Hexagon	32%	4	4	12	4	N/A	N/A	0%	50%	25%	18%	17%	33%	0.24	0.22	1.52	
C96	Hexagon	47%	4	4	12	4	N/A	N/A	0%	38%	19%	21%	20%	25%	0.24	0.22	1.52	
C101	Parallelogram	63%	4	4	12	4	N/A	N/A	0%	27%	13%	23%	23%	18%	0.24	0.22	1.52	
C102	Parallelogram	30%	4	4	12	4	N/A	N/A	0%	51%	25%	17%	17%	34%	0.24	0.22	1.52	
C103	Parallelogram	37%	4	4	12	4	N/A	N/A	0%	46%	23%	19%	18%	30%	0.24	0.22	1.52	
C104	Parallelogram	32%	4	4	12	4	N/A	N/A	0%	50%	25%	18%	17%	33%	0.24	0.22	1.52	
C105	Parallelogram	23%	4	4	12	4	N/A	N/A	0%	56%	28%	16%	15%	37%	0.24	0.22	1.52	
C106	Parallelogram	50%	4	4	12	4	N/A	N/A	0%	37%	18%	21%	20%	24%	0.24	0.22	1.52	
C111	Parallelogram	53%	4	4	12	4	N/A	N/A	0%	34%	17%	22%	21%	22%	0.24	0.22	1.52	
C112	Parallelogram	40%	4	4	12	4	N/A	N/A	0%	44%	22%	19%	19%	29%	0.24	0.22	1.52	
C113	Parallelogram	43%	4	4	12	4	N/A	N/A	0%	41%	20%	20%	19%	27%	0.24	0.22	1.52	
C114	Parallelogram	27%	4	4	12	4	N/A	N/A	0%	54%	26%	17%	16%	35%	0.24	0.22	1.52	
C115	Parallelogram	40%	4	4	12	4	N/A	N/A	0%	44%	22%	19%	19%	29%	0.24	0.22	1.52	
C116	Parallelogram	27%	4	4	12	4	N/A	N/A	0%	54%	26%	17%	16%	35%	0.24	0.22	1.52	

Panel Layers			Layers						UV %	Visible Light Transmittance	Total Solar Transmittance	Visible Reflectance		Solar Heat Gain Coefficient	U-Value (BTU/hrft2F)		Light to Solar Gain
LowIron-LowIron-Spacer-LowEclear			Class L1	Class L2	Spacer	Class L3	Spacer	Class L4				Exterior	Interior		Winter Nighttime	Summer Daytime	
Panel Type	Shape	Cell Coverage Area	Thickness	Thickness	Size	Thickness	Size	Thickness									
C74	Triangle	47%	6	6	12	6	N/A	N/A	0%	38%	18%	21%	20%	25%	0.24	0.22	1.50
C75	Triangle	37%	6	6	12	6	N/A	N/A	0%	45%	22%	19%	18%	30%	0.24	0.22	1.50
C76	Triangle	41%	6	6	12	6	N/A	N/A	0%	42%	21%	19%	19%	28%	0.24	0.22	1.50
C17	Hexagon	48%	6	6	12	6	N/A	N/A	0%	37%	18%	21%	20%	25%	0.24	0.22	1.50
C18	Hexagon	32%	6	6	12	6	N/A	N/A	0%	49%	24%	18%	17%	33%	0.24	0.22	1.50
C19	Hexagon	16%	6	6	12	6	N/A	N/A	0%	60%	29%	15%	14%	40%	0.24	0.22	1.50
C81	Hexagon	68%	6	6	12	6	N/A	N/A	0%	23%	11%	24%	24%	15%	0.24	0.22	1.50
C82	Hexagon	36%	6	6	12	6	N/A	N/A	0%	46%	22%	19%	18%	31%	0.24	0.22	1.50
C83	Hexagon	36%	6	6	12	6	N/A	N/A	0%	46%	22%	19%	18%	31%	0.24	0.22	1.50
C84	Hexagon	52%	6	6	12	6	N/A	N/A	0%	34%	17%	21%	21%	23%	0.24	0.22	1.50
C85	Hexagon	22%	6	6	12	6	N/A	N/A	0%	56%	27%	16%	15%	38%	0.24	0.22	1.50
C91	Hexagon	69%	6	6	12	6	N/A	N/A	0%	22%	11%	24%	24%	15%	0.24	0.22	1.50
C92	Hexagon	53%	6	6	12	6	N/A	N/A	0%	34%	16%	22%	21%	22%	0.24	0.22	1.50
C93	Hexagon	37%	6	6	12	6	N/A	N/A	0%	45%	22%	19%	18%	30%	0.24	0.22	1.50
C94	Hexagon	10%	6	6	12	6	N/A	N/A	0%	65%	32%	14%	13%	43%	0.24	0.22	1.50
C95	Hexagon	32%	6	6	12	6	N/A	N/A	0%	49%	24%	18%	17%	33%	0.24	0.22	1.50
C96	Hexagon	47%	6	6	12	6	N/A	N/A	0%	38%	18%	21%	20%	25%	0.24	0.22	1.50
C101	Parallelogram	63%	6	6	12	6	N/A	N/A	0%	27%	13%	23%	23%	18%	0.24	0.22	1.50
C102	Parallelogram	30%	6	6	12	6	N/A	N/A	0%	50%	25%	17%	17%	34%	0.24	0.22	1.50
C103	Parallelogram	37%	6	6	12	6	N/A	N/A	0%	46%	22%	19%	18%	30%	0.24	0.22	1.50
C104	Parallelogram	32%	6	6	12	6	N/A	N/A	0%	49%	24%	18%	17%	33%	0.24	0.22	1.50
C105	Parallelogram	23%	6	6	12	6	N/A	N/A	0%	55%	27%	16%	15%	37%	0.24	0.22	1.50
C106	Parallelogram	50%	6	6	12	6	N/A	N/A	0%	36%	18%	21%	20%	24%	0.24	0.22	1.50
C111	Parallelogram	53%	6	6	12	6	N/A	N/A	0%	34%	16%	22%	21%	22%	0.24	0.22	1.50
C112	Parallelogram	40%	6	6	12	6	N/A	N/A	0%	43%	21%	19%	19%	29%	0.24	0.22	1.50
C113	Parallelogram	43%	6	6	12	6	N/A	N/A	0%	41%	20%	20%	19%	27%	0.24	0.22	1.50
C114	Parallelogram	27%	6	6	12	6	N/A	N/A	0%	53%	26%	17%	16%	35%	0.24	0.22	1.50
C115	Parallelogram	40%	6	6	12	6	N/A	N/A	0%	43%	21%	19%	19%	29%	0.24	0.22	1.50
C116	Parallelogram	27%	6	6	12	6	N/A	N/A	0%	53%	26%	17%	16%	35%	0.24	0.22	1.50

Panel Layers			Layers							UV %	Visible Light Transmittance	Total Solar Transmittance	Visible Reflectance		Solar Heat Gain Coefficient	U-Value (BTU/hrft2F)		Light to Solar Gain
Panel Type	Shape	Cell Coverage Area	Glass L1 Thickness	Glass L2 Thickness	Spacer Size	Glass L3 Thickness	Spacer Size	Glass L4 Thickness	Exterior				Interior	Winter Nighttime		Summer Daytime		
C74	Triangle	47%	3	3	12	3	N/A	N/A	0%	40%	20%	21%	20%	25%	0.29	0.27	1.56	
C75	Triangle	37%	3	3	12	3	N/A	N/A	0%	47%	24%	19%	18%	30%	0.29	0.27	1.56	
C76	Triangle	41%	3	3	12	3	N/A	N/A	0%	44%	22%	19%	19%	28%	0.29	0.27	1.56	
C17	Hexagon	48%	3	3	12	3	N/A	N/A	0%	39%	20%	21%	20%	25%	0.29	0.27	1.56	
C18	Hexagon	32%	3	3	12	3	N/A	N/A	0%	51%	26%	18%	17%	33%	0.29	0.27	1.56	
C19	Hexagon	16%	3	3	12	3	N/A	N/A	0%	63%	32%	15%	14%	40%	0.29	0.27	1.56	
C81	Hexagon	68%	3	3	12	3	N/A	N/A	0%	24%	12%	24%	24%	15%	0.29	0.27	1.56	
C82	Hexagon	36%	3	3	12	3	N/A	N/A	0%	48%	24%	19%	18%	31%	0.29	0.27	1.56	
C83	Hexagon	36%	3	3	12	3	N/A	N/A	0%	48%	24%	19%	18%	31%	0.29	0.27	1.56	
C84	Hexagon	52%	3	3	12	3	N/A	N/A	0%	36%	18%	21%	21%	23%	0.29	0.27	1.56	
C85	Hexagon	22%	3	3	12	3	N/A	N/A	0%	59%	30%	16%	15%	38%	0.29	0.27	1.56	
C91	Hexagon	69%	3	3	12	3	N/A	N/A	0%	23%	12%	24%	24%	15%	0.29	0.27	1.56	
C92	Hexagon	53%	3	3	12	3	N/A	N/A	0%	35%	18%	22%	21%	22%	0.29	0.27	1.56	
C93	Hexagon	37%	3	3	12	3	N/A	N/A	0%	47%	24%	19%	18%	30%	0.29	0.27	1.56	
C94	Hexagon	10%	3	3	12	3	N/A	N/A	0%	68%	34%	14%	13%	43%	0.29	0.27	1.56	
C95	Hexagon	32%	3	3	12	3	N/A	N/A	0%	51%	26%	18%	17%	33%	0.29	0.27	1.56	
C96	Hexagon	47%	3	3	12	3	N/A	N/A	0%	40%	20%	21%	20%	25%	0.29	0.27	1.56	
C101	Parallelogram	63%	3	3	12	3	N/A	N/A	0%	28%	14%	23%	23%	18%	0.29	0.27	1.56	
C102	Parallelogram	30%	3	3	12	3	N/A	N/A	0%	53%	27%	17%	17%	34%	0.29	0.27	1.56	
C103	Parallelogram	37%	3	3	12	3	N/A	N/A	0%	48%	24%	19%	18%	30%	0.29	0.27	1.56	
C104	Parallelogram	32%	3	3	12	3	N/A	N/A	0%	51%	26%	18%	17%	33%	0.29	0.27	1.56	
C105	Parallelogram	23%	3	3	12	3	N/A	N/A	0%	58%	29%	16%	15%	37%	0.29	0.27	1.56	
C106	Parallelogram	50%	3	3	12	3	N/A	N/A	0%	38%	19%	21%	20%	24%	0.29	0.27	1.56	
C111	Parallelogram	53%	3	3	12	3	N/A	N/A	0%	35%	18%	22%	21%	22%	0.29	0.27	1.56	
C112	Parallelogram	40%	3	3	12	3	N/A	N/A	0%	45%	23%	19%	19%	29%	0.29	0.27	1.56	
C113	Parallelogram	43%	3	3	12	3	N/A	N/A	0%	43%	22%	20%	19%	27%	0.29	0.27	1.56	
C114	Parallelogram	27%	3	3	12	3	N/A	N/A	0%	55%	28%	17%	16%	35%	0.29	0.27	1.56	
C115	Parallelogram	40%	3	3	12	3	N/A	N/A	0%	45%	23%	19%	19%	29%	0.29	0.27	1.56	
C116	Parallelogram	27%	3	3	12	3	N/A	N/A	0%	55%	28%	17%	16%	35%	0.29	0.27	1.56	

Panel Layers			Layers							UV %	Visible Light Transmittance	Total Solar Transmittance	Visible Reflectance		Solar Heat Gain Coefficient	U-Value (BTU/hrft ² F)		Light to Solar Gain
Panel Type	Shape	Cell Coverage Area	Glass L1 Thickness	Glass L2 Thickness	Spacer Size	Glass L3 Thickness	Spacer Size	Glass L4 Thickness	Exterior				Interior	Winter Nighttime		Summer Daytime		
C74	Triangle	47%	4	4	12	4	N/A	N/A	0%	40%	20%	21%	20%	25%	0.28	0.26	1.56	
C75	Triangle	37%	4	4	12	4	N/A	N/A	0%	47%	24%	19%	18%	30%	0.28	0.26	1.56	
C76	Triangle	41%	4	4	12	4	N/A	N/A	0%	44%	22%	19%	19%	28%	0.28	0.26	1.56	
C17	Hexagon	48%	4	4	12	4	N/A	N/A	0%	39%	20%	21%	20%	25%	0.28	0.26	1.56	
C18	Hexagon	32%	4	4	12	4	N/A	N/A	0%	51%	26%	18%	17%	33%	0.28	0.26	1.56	
C19	Hexagon	16%	4	4	12	4	N/A	N/A	0%	63%	32%	15%	14%	40%	0.28	0.26	1.56	
C81	Hexagon	68%	4	4	12	4	N/A	N/A	0%	24%	12%	24%	24%	15%	0.28	0.26	1.56	
C82	Hexagon	36%	4	4	12	4	N/A	N/A	0%	48%	24%	19%	18%	31%	0.28	0.26	1.56	
C83	Hexagon	36%	4	4	12	4	N/A	N/A	0%	48%	24%	19%	18%	31%	0.28	0.26	1.56	
C84	Hexagon	52%	4	4	12	4	N/A	N/A	0%	36%	18%	21%	21%	23%	0.28	0.26	1.56	
C85	Hexagon	22%	4	4	12	4	N/A	N/A	0%	59%	30%	16%	15%	38%	0.28	0.26	1.56	
C91	Hexagon	69%	4	4	12	4	N/A	N/A	0%	23%	12%	24%	24%	15%	0.28	0.26	1.56	
C92	Hexagon	53%	4	4	12	4	N/A	N/A	0%	35%	18%	22%	21%	22%	0.28	0.26	1.56	
C93	Hexagon	37%	4	4	12	4	N/A	N/A	0%	47%	24%	19%	18%	30%	0.28	0.26	1.56	
C94	Hexagon	10%	4	4	12	4	N/A	N/A	0%	68%	34%	14%	13%	43%	0.28	0.26	1.56	
C95	Hexagon	32%	4	4	12	4	N/A	N/A	0%	51%	26%	18%	17%	33%	0.28	0.26	1.56	
C96	Hexagon	47%	4	4	12	4	N/A	N/A	0%	40%	20%	21%	20%	25%	0.28	0.26	1.56	
C101	Parallelogram	63%	4	4	12	4	N/A	N/A	0%	28%	14%	23%	23%	18%	0.28	0.26	1.56	
C102	Parallelogram	30%	4	4	12	4	N/A	N/A	0%	53%	27%	17%	17%	34%	0.28	0.26	1.56	
C103	Parallelogram	37%	4	4	12	4	N/A	N/A	0%	48%	24%	19%	18%	30%	0.28	0.26	1.56	
C104	Parallelogram	32%	4	4	12	4	N/A	N/A	0%	51%	26%	18%	17%	33%	0.28	0.26	1.56	
C105	Parallelogram	23%	4	4	12	4	N/A	N/A	0%	58%	29%	16%	15%	37%	0.28	0.26	1.56	
C106	Parallelogram	50%	4	4	12	4	N/A	N/A	0%	38%	19%	21%	20%	24%	0.28	0.26	1.56	
C111	Parallelogram	53%	4	4	12	4	N/A	N/A	0%	35%	18%	22%	21%	22%	0.28	0.26	1.56	
C112	Parallelogram	40%	4	4	12	4	N/A	N/A	0%	45%	23%	19%	19%	29%	0.28	0.26	1.56	
C113	Parallelogram	43%	4	4	12	4	N/A	N/A	0%	43%	22%	20%	19%	27%	0.28	0.26	1.56	
C114	Parallelogram	27%	4	4	12	4	N/A	N/A	0%	55%	28%	17%	16%	35%	0.28	0.26	1.56	
C115	Parallelogram	40%	4	4	12	4	N/A	N/A	0%	45%	23%	19%	19%	29%	0.28	0.26	1.56	
C116	Parallelogram	27%	4	4	12	4	N/A	N/A	0%	55%	28%	17%	16%	35%	0.28	0.26	1.56	

Panel Layers			Layers							UV %	Visible Light Transmittance	Total Solar Transmittance	Visible Reflectance		Solar Heat Gain Coefficient	U-Value (BTU/hrft2F)		Light to Solar Gain
Panel Type	Shape	Cell Coverage Area	Class L1 Thickness	Class L2 Thickness	Spacer Size	Class L3 Thickness	Spacer Size	Class L4 Thickness	Exterior				Interior	Winter Nighttime		Summer Daytime		
C74	Triangle	47%	6	6	12	6	N/A	N/A	0%	39%	20%	21%	20%	25%	0.24	0.22	1.54	
C75	Triangle	37%	6	6	12	6	N/A	N/A	0%	47%	24%	19%	18%	30%	0.24	0.22	1.54	
C76	Triangle	41%	6	6	12	6	N/A	N/A	0%	43%	22%	19%	19%	28%	0.24	0.22	1.54	
C17	Hexagon	48%	6	6	12	6	N/A	N/A	0%	38%	20%	21%	20%	25%	0.24	0.22	1.54	
C18	Hexagon	32%	6	6	12	6	N/A	N/A	0%	50%	26%	18%	17%	33%	0.24	0.22	1.54	
C19	Hexagon	16%	6	6	12	6	N/A	N/A	0%	62%	32%	15%	14%	40%	0.24	0.22	1.54	
C81	Hexagon	68%	6	6	12	6	N/A	N/A	0%	24%	12%	24%	24%	15%	0.24	0.22	1.54	
C82	Hexagon	36%	6	6	12	6	N/A	N/A	0%	47%	24%	19%	18%	31%	0.24	0.22	1.54	
C83	Hexagon	36%	6	6	12	6	N/A	N/A	0%	47%	24%	19%	18%	31%	0.24	0.22	1.54	
C84	Hexagon	52%	6	6	12	6	N/A	N/A	0%	35%	18%	21%	21%	23%	0.24	0.22	1.54	
C85	Hexagon	22%	6	6	12	6	N/A	N/A	0%	58%	30%	16%	15%	38%	0.24	0.22	1.54	
C91	Hexagon	69%	6	6	12	6	N/A	N/A	0%	23%	12%	24%	24%	15%	0.24	0.22	1.54	
C92	Hexagon	53%	6	6	12	6	N/A	N/A	0%	35%	18%	22%	21%	22%	0.24	0.22	1.54	
C93	Hexagon	37%	6	6	12	6	N/A	N/A	0%	46%	24%	19%	18%	30%	0.24	0.22	1.54	
C94	Hexagon	10%	6	6	12	6	N/A	N/A	0%	67%	34%	14%	13%	43%	0.24	0.22	1.54	
C95	Hexagon	32%	6	6	12	6	N/A	N/A	0%	51%	26%	18%	17%	33%	0.24	0.22	1.54	
C96	Hexagon	47%	6	6	12	6	N/A	N/A	0%	39%	20%	21%	20%	25%	0.24	0.22	1.54	
C101	Parallelogram	63%	6	6	12	6	N/A	N/A	0%	27%	14%	23%	23%	18%	0.24	0.22	1.54	
C102	Parallelogram	30%	6	6	12	6	N/A	N/A	0%	52%	27%	17%	17%	34%	0.24	0.22	1.54	
C103	Parallelogram	37%	6	6	12	6	N/A	N/A	0%	47%	24%	19%	18%	30%	0.24	0.22	1.54	
C104	Parallelogram	32%	6	6	12	6	N/A	N/A	0%	51%	26%	18%	17%	33%	0.24	0.22	1.54	
C105	Parallelogram	23%	6	6	12	6	N/A	N/A	0%	57%	29%	16%	15%	37%	0.24	0.22	1.54	
C106	Parallelogram	50%	6	6	12	6	N/A	N/A	0%	37%	19%	21%	20%	24%	0.24	0.22	1.54	
C111	Parallelogram	53%	6	6	12	6	N/A	N/A	0%	35%	18%	22%	21%	22%	0.24	0.22	1.54	
C112	Parallelogram	40%	6	6	12	6	N/A	N/A	0%	44%	23%	19%	19%	29%	0.24	0.22	1.54	
C113	Parallelogram	43%	6	6	12	6	N/A	N/A	0%	42%	22%	20%	19%	27%	0.24	0.22	1.54	
C114	Parallelogram	27%	6	6	12	6	N/A	N/A	0%	54%	28%	17%	16%	35%	0.24	0.22	1.54	
C115	Parallelogram	40%	6	6	12	6	N/A	N/A	0%	44%	23%	19%	19%	29%	0.24	0.22	1.54	
C116	Parallelogram	27%	6	6	12	6	N/A	N/A	0%	54%	28%	17%	16%	35%	0.24	0.22	1.54	

Panel Layers			Layers						UV %	Visible Light Transmittance	Total Solar Transmittance	Visible Reflectance		Solar Heat Gain Coefficient	U-Value (BTU/hrft2F)		Light to Solar Gain
LowIron-LowIron-Spacer-Clear-Spacer-Clear			Glass L1 Thickness	Glass L2 Thickness	Spacer Size	Glass L3 Thickness	Spacer Size	Glass L4 Thickness				Exterior	Interior		Winter Nighttime	Summer Daytime	
Panel Type	Shape	Cell Coverage Area															
C74	Triangle	47%	3	3	12	3	12	3	0%	40%	31%	25%	25%	36%	0.29	0.32	1.10
C75	Triangle	37%	3	3	12	3	12	3	0%	47%	37%	24%	24%	43%	0.29	0.32	1.10
C76	Triangle	41%	3	3	12	3	12	3	0%	44%	35%	25%	25%	40%	0.29	0.32	1.10
C17	Hexagon	48%	3	3	12	3	12	3	0%	39%	31%	25%	25%	35%	0.29	0.32	1.10
C18	Hexagon	32%	3	3	12	3	12	3	0%	51%	40%	24%	24%	46%	0.29	0.32	1.10
C19	Hexagon	16%	3	3	12	3	12	3	0%	63%	50%	22%	22%	57%	0.29	0.32	1.10
C81	Hexagon	68%	3	3	12	3	12	3	0%	24%	19%	27%	27%	22%	0.29	0.32	1.10
C82	Hexagon	36%	3	3	12	3	12	3	0%	48%	37%	24%	24%	43%	0.29	0.32	1.10
C83	Hexagon	36%	3	3	12	3	12	3	0%	48%	37%	24%	24%	43%	0.29	0.32	1.10
C84	Hexagon	52%	3	3	12	3	12	3	0%	36%	28%	26%	26%	32%	0.29	0.32	1.10
C85	Hexagon	22%	3	3	12	3	12	3	0%	59%	46%	23%	23%	53%	0.29	0.32	1.10
C91	Hexagon	69%	3	3	12	3	12	3	0%	23%	18%	27%	27%	21%	0.29	0.32	1.10
C92	Hexagon	53%	3	3	12	3	12	3	0%	35%	28%	26%	26%	32%	0.29	0.32	1.10
C93	Hexagon	37%	3	3	12	3	12	3	0%	47%	37%	24%	24%	43%	0.29	0.32	1.10
C94	Hexagon	10%	3	3	12	3	12	3	0%	68%	53%	22%	22%	61%	0.29	0.32	1.10
C95	Hexagon	32%	3	3	12	3	12	3	0%	51%	40%	24%	24%	47%	0.29	0.32	1.10
C96	Hexagon	47%	3	3	12	3	12	3	0%	40%	31%	25%	25%	36%	0.29	0.32	1.10
C101	Parallelogram	63%	3	3	12	3	12	3	0%	28%	22%	27%	27%	25%	0.29	0.32	1.10
C102	Parallelogram	30%	3	3	12	3	12	3	0%	53%	41%	24%	24%	48%	0.29	0.32	1.10
C103	Parallelogram	37%	3	3	12	3	12	3	0%	48%	37%	24%	24%	43%	0.29	0.32	1.10
C104	Parallelogram	32%	3	3	12	3	12	3	0%	51%	40%	24%	24%	47%	0.29	0.32	1.10
C105	Parallelogram	23%	3	3	12	3	12	3	0%	58%	45%	23%	23%	52%	0.29	0.32	1.10
C106	Parallelogram	50%	3	3	12	3	12	3	0%	38%	30%	25%	25%	34%	0.29	0.32	1.10
C111	Parallelogram	53%	3	3	12	3	12	3	0%	35%	28%	26%	26%	32%	0.29	0.32	1.10
C112	Parallelogram	40%	3	3	12	3	12	3	0%	45%	35%	25%	25%	41%	0.29	0.32	1.10
C113	Parallelogram	43%	3	3	12	3	12	3	0%	43%	33%	25%	25%	39%	0.29	0.32	1.10
C114	Parallelogram	27%	3	3	12	3	12	3	0%	55%	43%	23%	23%	50%	0.29	0.32	1.10
C115	Parallelogram	40%	3	3	12	3	12	3	0%	45%	35%	25%	25%	41%	0.29	0.32	1.10
C116	Parallelogram	27%	3	3	12	3	12	3	0%	55%	43%	23%	23%	50%	0.29	0.32	1.10

Panel Layers			Layers						UV %	Visible Light Transmittance	Total Solar Transmittance	Visible Reflectance		Solar Heat Gain Coefficient	U-Value (BTU/hrft2F)		Light to Solar Gain
LowIron-LowIron-Spacer-Clear-Spacer-Clear			Glass L1 Thickness	Glass L2 Thickness	Spacer Size	Glass L3 Thickness	Spacer Size	Glass L4 Thickness				Exterior	Interior		Winter Nighttime	Summer Daytime	
Panel Type	Shape	Cell Coverage Area															
C74	Triangle	47%	4	4	12	4	12	4	1%	39%	30%	25%	25%	35%	0.28	0.32	1.10
C75	Triangle	37%	4	4	12	4	12	4	1%	47%	35%	24%	24%	42%	0.28	0.32	1.10
C76	Triangle	41%	4	4	12	4	12	4	1%	43%	33%	25%	25%	39%	0.28	0.32	1.10
C17	Hexagon	48%	4	4	12	4	12	4	1%	38%	29%	25%	25%	35%	0.28	0.32	1.10
C18	Hexagon	32%	4	4	12	4	12	4	1%	50%	38%	24%	24%	45%	0.28	0.32	1.10
C19	Hexagon	16%	4	4	12	4	12	4	1%	62%	47%	22%	22%	56%	0.28	0.32	1.10
C81	Hexagon	68%	4	4	12	4	12	4	0%	24%	18%	27%	27%	21%	0.28	0.32	1.10
C82	Hexagon	36%	4	4	12	4	12	4	1%	47%	36%	24%	24%	43%	0.28	0.32	1.10
C83	Hexagon	36%	4	4	12	4	12	4	1%	47%	36%	24%	24%	43%	0.28	0.32	1.10
C84	Hexagon	52%	4	4	12	4	12	4	0%	35%	27%	26%	26%	32%	0.28	0.32	1.10
C85	Hexagon	22%	4	4	12	4	12	4	1%	58%	44%	23%	23%	52%	0.28	0.32	1.10
C91	Hexagon	69%	4	4	12	4	12	4	0%	23%	17%	27%	27%	21%	0.28	0.32	1.10
C92	Hexagon	53%	4	4	12	4	12	4	0%	35%	26%	26%	26%	31%	0.28	0.32	1.10
C93	Hexagon	37%	4	4	12	4	12	4	1%	46%	35%	24%	24%	42%	0.28	0.32	1.10
C94	Hexagon	10%	4	4	12	4	12	4	1%	67%	50%	22%	22%	60%	0.28	0.32	1.10
C95	Hexagon	32%	4	4	12	4	12	4	1%	51%	38%	24%	24%	46%	0.28	0.32	1.10
C96	Hexagon	47%	4	4	12	4	12	4	1%	39%	30%	25%	25%	35%	0.28	0.32	1.10
C101	Parallelogram	63%	4	4	12	4	12	4	0%	27%	21%	27%	27%	25%	0.28	0.32	1.10
C102	Parallelogram	30%	4	4	12	4	12	4	1%	52%	39%	24%	24%	47%	0.28	0.32	1.10
C103	Parallelogram	37%	4	4	12	4	12	4	1%	47%	36%	24%	24%	42%	0.28	0.32	1.10
C104	Parallelogram	32%	4	4	12	4	12	4	1%	51%	38%	24%	24%	46%	0.28	0.32	1.10
C105	Parallelogram	23%	4	4	12	4	12	4	1%	57%	43%	23%	23%	51%	0.28	0.32	1.10
C106	Parallelogram	50%	4	4	12	4	12	4	1%	37%	28%	25%	25%	34%	0.28	0.32	1.10
C111	Parallelogram	53%	4	4	12	4	12	4	0%	35%	26%	26%	26%	31%	0.28	0.32	1.10
C112	Parallelogram	40%	4	4	12	4	12	4	1%	44%	34%	25%	25%	40%	0.28	0.32	1.10
C113	Parallelogram	43%	4	4	12	4	12	4	1%	42%	32%	25%	25%	38%	0.28	0.32	1.10
C114	Parallelogram	27%	4	4	12	4	12	4	1%	54%	41%	23%	23%	49%	0.28	0.32	1.10
C115	Parallelogram	40%	4	4	12	4	12	4	1%	44%	34%	25%	25%	40%	0.28	0.32	1.10
C116	Parallelogram	27%	4	4	12	4	12	4	1%	54%	41%	23%	23%	49%	0.28	0.32	1.10

Panel Layers			Layers							UV %	Visible Light Transmittance	Total Solar Transmittance	Visible Reflectance		Solar Heat Gain Coefficient	U-Value (BTU/hrft2F)		Light to Solar Gain
Panel Type	Shape	Cell Coverage Area	Class L1 Thickness	Class L2 Thickness	Spacer Size	Class L3 Thickness	Spacer Size	Class L4 Thickness	Exterior				Interior	Winter Nighttime		Summer Daytime		
C74	Triangle	47%	6	6	12	6	12	6	0%	38%	26%	25%	25%	34%	0.28	0.32	1.13	
C75	Triangle	37%	6	6	12	6	12	6	0%	45%	32%	24%	24%	40%	0.28	0.32	1.13	
C76	Triangle	41%	6	6	12	6	12	6	0%	42%	29%	25%	24%	38%	0.28	0.32	1.13	
C17	Hexagon	48%	6	6	12	6	12	6	0%	37%	26%	25%	25%	33%	0.28	0.32	1.13	
C18	Hexagon	32%	6	6	12	6	12	6	0%	49%	34%	24%	23%	43%	0.28	0.32	1.13	
C19	Hexagon	16%	6	6	12	6	12	6	0%	60%	42%	22%	22%	54%	0.28	0.32	1.13	
C81	Hexagon	68%	6	6	12	6	12	6	0%	23%	16%	27%	27%	20%	0.28	0.32	1.13	
C82	Hexagon	36%	6	6	12	6	12	6	0%	46%	32%	24%	24%	41%	0.28	0.32	1.13	
C83	Hexagon	36%	6	6	12	6	12	6	0%	46%	32%	24%	24%	41%	0.28	0.32	1.13	
C84	Hexagon	52%	6	6	12	6	12	6	0%	34%	24%	26%	25%	31%	0.28	0.32	1.13	
C85	Hexagon	22%	6	6	12	6	12	6	0%	56%	39%	23%	22%	50%	0.28	0.32	1.13	
C91	Hexagon	69%	6	6	12	6	12	6	0%	22%	16%	27%	27%	20%	0.28	0.32	1.13	
C92	Hexagon	53%	6	6	12	6	12	6	0%	34%	23%	26%	25%	30%	0.28	0.32	1.13	
C93	Hexagon	37%	6	6	12	6	12	6	0%	45%	31%	24%	24%	40%	0.28	0.32	1.13	
C94	Hexagon	10%	6	6	12	6	12	6	0%	65%	45%	22%	21%	58%	0.28	0.32	1.13	
C95	Hexagon	32%	6	6	12	6	12	6	0%	49%	34%	24%	23%	44%	0.28	0.32	1.13	
C96	Hexagon	47%	6	6	12	6	12	6	0%	38%	26%	25%	25%	34%	0.28	0.32	1.13	
C101	Parallelogram	63%	6	6	12	6	12	6	0%	27%	18%	27%	26%	24%	0.28	0.32	1.13	
C102	Parallelogram	30%	6	6	12	6	12	6	0%	50%	35%	24%	23%	45%	0.28	0.32	1.13	
C103	Parallelogram	37%	6	6	12	6	12	6	0%	46%	32%	24%	24%	41%	0.28	0.32	1.13	
C104	Parallelogram	32%	6	6	12	6	12	6	0%	49%	34%	24%	23%	44%	0.28	0.32	1.13	
C105	Parallelogram	23%	6	6	12	6	12	6	0%	55%	38%	23%	22%	49%	0.28	0.32	1.13	
C106	Parallelogram	50%	6	6	12	6	12	6	0%	36%	25%	25%	25%	32%	0.28	0.32	1.13	
C111	Parallelogram	53%	6	6	12	6	12	6	0%	34%	23%	26%	25%	30%	0.28	0.32	1.13	
C112	Parallelogram	40%	6	6	12	6	12	6	0%	43%	30%	25%	24%	38%	0.28	0.32	1.13	
C113	Parallelogram	43%	6	6	12	6	12	6	0%	41%	28%	25%	24%	36%	0.28	0.32	1.13	
C114	Parallelogram	27%	6	6	12	6	12	6	0%	53%	37%	23%	23%	47%	0.28	0.32	1.13	
C115	Parallelogram	40%	6	6	12	6	12	6	0%	43%	30%	25%	24%	38%	0.28	0.32	1.13	
C116	Parallelogram	27%	6	6	12	6	12	6	0%	53%	37%	23%	23%	47%	0.28	0.32	1.13	

Panel Layers			Layers							UV %	Visible Light Transmittance	Total Solar Transmittance	Visible Reflectance		Solar Heat Gain Coefficient	U-Value (BTU/hrft2F)		Light to Solar Gain
LowIron-LowIron-Spacer-LowIron	LowIron-Spacer-LowIron	Cell Coverage Area	Class L1 Thickness	Class L2 Thickness	Spacer Size	Class L3 Thickness	Spacer Size	Class L4 Thickness	Exterior				Interior	Winter Nighttime		Summer Daytime		
Non-Active	Any Shape	0%	3	3	12	3	12	3	0%	77%	69%	21%	21%	72%	0.29	0.32	1.07	
A1	Rectangle	92%	3	3	12	3	12	3	0%	6%	29%	29%	6%	0.29	0.32	1.07		
A2	Rectangle	61%	3	3	12	3	12	3	0%	30%	27%	27%	28%	0.29	0.32	1.07		
A3	Rectangle	61%	3	3	12	3	12	3	0%	30%	27%	27%	28%	0.29	0.32	1.07		
A4	Rectangle	31%	3	3	12	3	12	3	0%	53%	48%	24%	24%	50%	0.29	0.32	1.07	
A5	Rectangle	31%	3	3	12	3	12	3	0%	53%	48%	24%	24%	50%	0.29	0.32	1.07	
A6	Rectangle	15%	3	3	12	3	12	3	0%	65%	58%	22%	22%	61%	0.29	0.32	1.07	
A7	Rectangle	31%	3	3	12	3	12	3	0%	53%	48%	24%	24%	50%	0.29	0.32	1.07	
A8	Rectangle	46%	3	3	12	3	12	3	0%	42%	37%	25%	25%	39%	0.29	0.32	1.07	
A21	Rectangle	76%	3	3	12	3	12	3	0%	18%	16%	28%	28%	17%	0.29	0.32	1.07	
A22	Rectangle	38%	3	3	12	3	12	3	0%	48%	43%	24%	24%	44%	0.29	0.32	1.07	
A23	Rectangle	15%	3	3	12	3	12	3	0%	65%	58%	22%	22%	61%	0.29	0.32	1.07	
A24	Rectangle	46%	3	3	12	3	12	3	0%	42%	37%	25%	25%	39%	0.29	0.32	1.07	
A25	Rectangle	31%	3	3	12	3	12	3	0%	53%	48%	24%	24%	50%	0.29	0.32	1.07	
A26	Rectangle	15%	3	3	12	3	12	3	0%	65%	58%	22%	22%	61%	0.29	0.32	1.07	
A27	Rectangle	23%	3	3	12	3	12	3	0%	59%	53%	23%	23%	55%	0.29	0.32	1.07	
A31	Rectangle	31%	3	3	12	3	12	3	0%	53%	48%	24%	24%	50%	0.29	0.32	1.07	
A32	Rectangle	20%	3	3	12	3	12	3	0%	61%	55%	23%	23%	57%	0.29	0.32	1.07	
A33	Rectangle	10%	3	3	12	3	12	3	0%	69%	62%	22%	22%	65%	0.29	0.32	1.07	
A34	Rectangle	5%	3	3	12	3	12	3	0%	73%	65%	21%	21%	68%	0.29	0.32	1.07	
A41	Rectangle	74%	3	3	12	3	12	3	0%	20%	18%	28%	28%	19%	0.29	0.32	1.07	
A42	Rectangle	47%	3	3	12	3	12	3	0%	41%	36%	25%	25%	38%	0.29	0.32	1.07	
A43	Rectangle	14%	3	3	12	3	12	3	0%	66%	59%	22%	22%	62%	0.29	0.32	1.07	
A44	Rectangle	10%	3	3	12	3	12	3	0%	69%	62%	22%	22%	65%	0.29	0.32	1.07	
A45	Rectangle	43%	3	3	12	3	12	3	0%	44%	39%	25%	25%	41%	0.29	0.32	1.07	
A46	Rectangle	60%	3	3	12	3	12	3	0%	31%	28%	26%	26%	29%	0.29	0.32	1.07	
A51	Rectangle	57%	3	3	12	3	12	3	0%	33%	29%	26%	26%	31%	0.29	0.32	1.07	
A52	Rectangle	27%	3	3	12	3	12	3	0%	56%	51%	23%	23%	53%	0.29	0.32	1.07	
A53	Rectangle	22%	3	3	12	3	12	3	0%	60%	54%	23%	23%	56%	0.29	0.32	1.07	
A54	Rectangle	87%	3	3	12	3	12	3	0%	10%	9%	29%	29%	10%	0.29	0.32	1.07	
A55	Rectangle	69%	3	3	12	3	12	3	0%	24%	22%	27%	27%	22%	0.29	0.32	1.07	
A56	Rectangle	61%	3	3	12	3	12	3	0%	30%	27%	27%	27%	28%	0.29	0.32	1.07	
A111	Rectangle	46%	3	3	12	3	12	3	0%	42%	37%	25%	25%	39%	0.29	0.32	1.07	
A112	Rectangle	23%	3	3	12	3	12	3	0%	59%	53%	23%	23%	55%	0.29	0.32	1.07	
A113	Rectangle	23%	3	3	12	3	12	3	0%	59%	53%	23%	23%	55%	0.29	0.32	1.07	
A114	Rectangle	23%	3	3	12	3	12	3	0%	59%	53%	23%	23%	55%	0.29	0.32	1.07	
A115	Rectangle	11%	3	3	12	3	12	3	0%	68%	61%	22%	22%	64%	0.29	0.32	1.07	
A116	Rectangle	34%	3	3	12	3	12	3	0%	51%	45%	24%	24%	47%	0.29	0.32	1.07	
A121	Rectangle	36%	3	3	12	3	12	3	0%	50%	44%	24%	24%	46%	0.29	0.32	1.07	
A122	Rectangle	15%	3	3	12	3	12	3	0%	65%	58%	22%	22%	61%	0.29	0.32	1.07	
A123	Rectangle	20%	3	3	12	3	12	3	0%	61%	55%	23%	23%	57%	0.29	0.32	1.07	
A124	Rectangle	36%	3	3	12	3	12	3	0%	50%	44%	24%	24%	46%	0.29	0.32	1.07	
A125	Rectangle	25%	3	3	12	3	12	3	0%	57%	51%	23%	23%	54%	0.29	0.32	1.07	
A126	Rectangle	18%	3	3	12	3	12	3	0%	63%	57%	23%	23%	59%	0.29	0.32	1.07	
A127	Rectangle	18%	3	3	12	3	12	3	0%	63%	57%	23%	23%	59%	0.29	0.32	1.07	
A128	Rectangle	8%	3	3	12	3	12	3	0%	71%	64%	22%	22%	66%	0.29	0.32	1.07	
B1	Rectangle-Half S	87%	3	3	12	3	12	3	0%	10%	9%	29%	29%	9%	0.29	0.32	1.07	
B2	Rectangle-Half S	58%	3	3	12	3	12	3	0%	32%	29%	26%	26%	30%	0.29	0.32	1.07	
B3	Rectangle-Half S	58%	3	3	12	3	12	3	0%	32%	29%	26%	26%	30%	0.29	0.32	1.07	
B4	Rectangle-Half S	29%	3	3	12	3	12	3	0%	55%	49%	24%	24%	51%	0.29	0.32	1.07	
B5	Rectangle-Half S	29%	3	3	12	3	12	3	0%	55%	49%	24%	24%	51%	0.29	0.32	1.07	
B6	Rectangle-Half S	15%	3	3	12	3	12	3	0%	66%	59%	22%	22%	62%	0.29	0.32	1.07	
B7	Rectangle-Half S	29%	3	3	12	3	12	3	0%	55%	49%	24%	24%	51%	0.29	0.32	1.07	
B8	Rectangle-Half S	44%	3	3	12	3	12	3	0%	43%	39%	25%	25%	41%	0.29	0.32	1.07	
B21	Rectangle-Half S	73%	3	3	12	3	12	3	0%	21%	19%	28%	28%	20%	0.29	0.32	1.07	
B22	Rectangle-Half S	44%	3	3	12	3	12	3	0%	43%	39%	25%	25%	41%	0.29	0.32	1.07	
B23	Rectangle-Half S	15%	3	3	12	3	12	3	0%	66%	59%	22%	22%	62%	0.29	0.32	1.07	
B24	Rectangle-Half S	58%	3	3	12	3	12	3	0%	32%	29%	26%	26%	30%	0.29	0.32	1.07	
B25	Rectangle-Half S	29%	3	3	12	3	12	3	0%	55%	49%	24%	24%	51%	0.29	0.32	1.07	
B26	Rectangle-Half S	44%	3	3	12	3	12	3	0%	43%	39%	25%	25%	41%	0.29	0.32	1.07	
B31	Rectangle-Half S	39%	3	3	12	3	12	3	0%	47%	42%	24%	24%	44%	0.29	0.32	1.07	
B32	Rectangle-Half S	19%	3	3	12	3	12	3	0%	62%	56%	23%	23%	58%	0.29	0.32	1.07	
B33	Rectangle-Half S	39%	3	3	12	3	12	3	0%	47%	42%	24%	24%	44%	0.29	0.32	1.07	
B34	Rectangle-Half S	19%	3	3	12	3	12	3	0%	62%	56%	23%	23%	58%	0.29	0.32	1.07	
B35	Rectangle-Half S	10%	3	3	12	3	12	3	0%	70%	62%	22%	22%	65%	0.29	0.32	1.07	
B36	Rectangle-Half S	32%	3	3	12	3	12	3	0%	53%	47%	24%	24%	49%	0.29	0.32	1.07	
C11	Circle	60%	3	3	12	3	12	3	0%	31%	28%	26%	26%	29%	0.29	0.32	1.07	
C12	Circle	40%	3	3	12	3	12	3	0%	46%	41%	25%	25%	43%	0.29	0.32	1.07	
C13	Circle	20%	3	3	12	3	12	3	0%	62%	55%	23%	23%	58%	0.29	0.32	1.07	
C21	Circle	78%	3	3	12	3	12	3	0%	17%	15%	28%	28%	16%	0.29	0.32	1.07	
C22	Circle	79%	3	3	12	3	12	3	0%	16%	14%	28%	28%	15%	0.29	0.32	1.07	
C23	Circle	42%	3	3	12	3	12	3	0%	44%	40%	25%	25%	41%	0.29	0.32	1.07	
C24	Circle	38%	3	3	12	3	12	3	0%	47%	43%	24%	24%	44%	0.29	0.32	1.07	
C25	Circle	65%	3	3	12	3	12	3	0%	27%	24%	27%	27%	25%	0.29	0.32	1.07	
C31	Circle	70%	3	3	12	3	12	3	0%	23%	21%	27%	27%	22%	0.29	0.32	1.07	
C32	Circle	57%	3	3	12	3	12	3	0%	33%	30%	26%	26%	31%	0.29	0.32	1.07	
C33	Circle	35%	3	3	12	3	12	3	0%	50%	45%	24%	24%	47%	0.29	0.32	1.07	
C34	Circle	63%	3	3	12	3	12	3	0%	29%	26%	27%	27%	27%	0.29	0.32	1.07	
C35	Circle	40%	3	3	12	3	12	3	0%	46%	41%	25%	25%	43%	0.29	0.32	1.07	
C36	Circle	20%	3	3	12	3	12	3	0%	61%	55%	23%	23%	57%	0.29	0.32	1.07	
C41	Circle	52%	3	3	12	3	12	3	0%	37%	33%	26%	26%	34%	0.29	0.32	1.07	
C42	Circle	34%	3	3	12	3	12	3	0%	51%	45%	24%	24%	47%	0.29	0.32	1.07	
C43	Circle	44%	3	3	12	3	12	3	0%	43%	39%	25%	25%	40%	0.29	0.32	1.07	
C51	Circle	54%	3	3	12	3	12	3	0%	36%	32%	26%	26%	33%	0.29	0.32	1.07	
C52	Circle	44%	3	3	12	3	12	3	0%	43%	39%	25%	25%	40%	0.29	0.32	1.07	
C53	Circle	46%	3	3	12	3	12	3	0%	42%	37%	25%	25%	39%	0.29	0.32	1.07	
C54	Circle	49%	3	3	12	3	12	3	0%	39%	35%	25%	25%	37%	0.29	0.32	1.07	
C55	Circle	36%	3	3	12	3	12	3	0%	49%	44%	24%	24%	46%	0.29	0.32	1.07	
C14	Triangle	51%	3	3	12	3	12	3	0%	38%	34%	26%	26%	35%	0.29	0.32	1.07	
C15	Triangle	36%	3	3	12	3	12	3	0%	50%	44%	24%	24%	46%	0.29	0.32	1.07	
C16	Triangle	31%	3	3	12	3	12	3	0%	53%	48%	24%	24%	50%	0.29	0.32	1.07	
C61	Triangle	65%	3	3	12	3	12	3	0%	27%	24%	27%						

Panel Layers			Layers						UV %	Visible Light Transmittance	Total Solar Transmittance	Visible Reflectance		Solar Heat Gain Coefficient	U-Value (BTU/hrft2F)		Light to Solar Gain
Panel Type	Shape	Cell Coverage Area	Class L1 Thickness	Class L2 Thickness	Spacer Size	Class L3 Thickness	Spacer Size	Class L4 Thickness				Exterior	Interior		Winter Nighttime	Summer Daytime	
C74	Triangle	47%	3	3	12	3	12	3	0%	41%	36%	25%	25%	38%	0.29	0.32	1.07
C75	Triangle	37%	3	3	12	3	12	3	0%	49%	44%	24%	24%	45%	0.29	0.32	1.07
C76	Triangle	41%	3	3	12	3	12	3	0%	45%	40%	25%	25%	42%	0.29	0.32	1.07
C17	Hexagon	48%	3	3	12	3	12	3	0%	40%	36%	25%	25%	37%	0.29	0.32	1.07
C18	Hexagon	32%	3	3	12	3	12	3	0%	52%	47%	24%	24%	49%	0.29	0.32	1.07
C19	Hexagon	16%	3	3	12	3	12	3	0%	65%	58%	22%	22%	60%	0.29	0.32	1.07
C81	Hexagon	68%	3	3	12	3	12	3	0%	25%	22%	27%	27%	23%	0.29	0.32	1.07
C82	Hexagon	36%	3	3	12	3	12	3	0%	49%	44%	24%	24%	46%	0.29	0.32	1.07
C83	Hexagon	36%	3	3	12	3	12	3	0%	49%	44%	24%	24%	46%	0.29	0.32	1.07
C84	Hexagon	52%	3	3	12	3	12	3	0%	37%	33%	26%	26%	34%	0.29	0.32	1.07
C85	Hexagon	22%	3	3	12	3	12	3	0%	60%	54%	23%	23%	56%	0.29	0.32	1.07
C91	Hexagon	69%	3	3	12	3	12	3	0%	24%	21%	27%	27%	22%	0.29	0.32	1.07
C92	Hexagon	53%	3	3	12	3	12	3	0%	36%	32%	26%	26%	34%	0.29	0.32	1.07
C93	Hexagon	37%	3	3	12	3	12	3	0%	48%	43%	24%	24%	45%	0.29	0.32	1.07
C94	Hexagon	10%	3	3	12	3	12	3	0%	69%	62%	22%	22%	65%	0.29	0.32	1.07
C95	Hexagon	32%	3	3	12	3	12	3	0%	53%	47%	24%	24%	49%	0.29	0.32	1.07
C96	Hexagon	47%	3	3	12	3	12	3	0%	41%	36%	25%	25%	38%	0.29	0.32	1.07
C101	Parallelogram	63%	3	3	12	3	12	3	0%	28%	25%	27%	27%	27%	0.29	0.32	1.07
C102	Parallelogram	30%	3	3	12	3	12	3	0%	54%	48%	24%	24%	50%	0.29	0.32	1.07
C103	Parallelogram	37%	3	3	12	3	12	3	0%	49%	44%	24%	24%	46%	0.29	0.32	1.07
C104	Parallelogram	32%	3	3	12	3	12	3	0%	53%	47%	24%	24%	49%	0.29	0.32	1.07
C105	Parallelogram	23%	3	3	12	3	12	3	0%	59%	53%	23%	23%	55%	0.29	0.32	1.07
C106	Parallelogram	50%	3	3	12	3	12	3	0%	39%	35%	25%	25%	36%	0.29	0.32	1.07
C111	Parallelogram	53%	3	3	12	3	12	3	0%	36%	32%	26%	26%	34%	0.29	0.32	1.07
C112	Parallelogram	40%	3	3	12	3	12	3	0%	46%	41%	25%	25%	43%	0.29	0.32	1.07
C113	Parallelogram	43%	3	3	12	3	12	3	0%	44%	39%	25%	25%	41%	0.29	0.32	1.07
C114	Parallelogram	27%	3	3	12	3	12	3	0%	57%	51%	23%	23%	53%	0.29	0.32	1.07
C115	Parallelogram	40%	3	3	12	3	12	3	0%	46%	41%	25%	25%	43%	0.29	0.32	1.07
C116	Parallelogram	27%	3	3	12	3	12	3	0%	57%	51%	23%	23%	53%	0.29	0.32	1.07

Panel Layers			Layers						UV %	Visible Light Transmittance	Total Solar Transmittance	Visible Reflectance		Solar Heat Gain Coefficient	U-Value (BTU/hrft2F)		Light to Solar Gain
LowIron-LowIron-Spacer-LowIron-Spacer-LowIron		Cell Coverage Area	Glass L1 Thickness	Glass L2 Thickness	Spacer Size	Glass L3 Thickness	Spacer Size	Glass L4 Thickness				Exterior	Interior		Winter Nighttime	Summer Daytime	
Panel Type	Shape	Cell Coverage Area	Glass L1 Thickness	Glass L2 Thickness	Spacer Size	Glass L3 Thickness	Spacer Size	Glass L4 Thickness	UV %	Visible Light Transmittance	Total Solar Transmittance	Exterior	Interior	Solar Heat Gain Coefficient	Winter Nighttime	Summer Daytime	Light to Solar Gain
Non-Active	Any Shape	0%	4	4	12	4	12	4	1%	77%	68%	21%	21%	71%	0.28	0.32	1.08
A1	Rectangle	92%	4	4	12	4	12	4	0%	29%	6%	29%	29%	6%	0.28	0.32	1.08
A2	Rectangle	61%	4	4	12	4	12	4	0%	30%	26%	27%	27%	28%	0.28	0.32	1.08
A3	Rectangle	61%	4	4	12	4	12	4	0%	30%	26%	27%	27%	28%	0.28	0.32	1.08
A4	Rectangle	31%	4	4	12	4	12	4	1%	53%	47%	24%	24%	49%	0.28	0.32	1.08
A5	Rectangle	31%	4	4	12	4	12	4	1%	53%	47%	24%	24%	49%	0.28	0.32	1.08
A6	Rectangle	15%	4	4	12	4	12	4	1%	65%	58%	22%	22%	60%	0.28	0.32	1.08
A7	Rectangle	31%	4	4	12	4	12	4	1%	53%	47%	24%	24%	49%	0.28	0.32	1.08
A8	Rectangle	46%	4	4	12	4	12	4	1%	42%	37%	25%	25%	38%	0.28	0.32	1.08
A21	Rectangle	76%	4	4	12	4	12	4	0%	18%	16%	28%	28%	17%	0.28	0.32	1.08
A22	Rectangle	38%	4	4	12	4	12	4	1%	48%	42%	24%	24%	44%	0.28	0.32	1.08
A23	Rectangle	15%	4	4	12	4	12	4	1%	65%	58%	22%	22%	60%	0.28	0.32	1.08
A24	Rectangle	46%	4	4	12	4	12	4	1%	42%	37%	25%	25%	38%	0.28	0.32	1.08
A25	Rectangle	31%	4	4	12	4	12	4	1%	53%	47%	24%	24%	49%	0.28	0.32	1.08
A26	Rectangle	15%	4	4	12	4	12	4	1%	65%	58%	22%	22%	60%	0.28	0.32	1.08
A27	Rectangle	23%	4	4	12	4	12	4	1%	59%	52%	23%	23%	55%	0.28	0.32	1.08
A31	Rectangle	31%	4	4	12	4	12	4	1%	53%	47%	24%	24%	49%	0.28	0.32	1.08
A32	Rectangle	20%	4	4	12	4	12	4	1%	61%	54%	23%	23%	57%	0.28	0.32	1.08
A33	Rectangle	10%	4	4	12	4	12	4	1%	69%	61%	22%	22%	64%	0.28	0.32	1.08
A34	Rectangle	5%	4	4	12	4	12	4	1%	73%	65%	21%	21%	67%	0.28	0.32	1.08
A41	Rectangle	74%	4	4	12	4	12	4	0%	20%	18%	28%	28%	19%	0.28	0.32	1.08
A42	Rectangle	47%	4	4	12	4	12	4	1%	41%	36%	25%	25%	38%	0.28	0.32	1.08
A43	Rectangle	14%	4	4	12	4	12	4	1%	66%	58%	22%	22%	61%	0.28	0.32	1.08
A44	Rectangle	10%	4	4	12	4	12	4	1%	69%	61%	22%	22%	64%	0.28	0.32	1.08
A45	Rectangle	43%	4	4	12	4	12	4	1%	44%	39%	25%	25%	40%	0.28	0.32	1.08
A46	Rectangle	60%	4	4	12	4	12	4	0%	31%	27%	26%	26%	28%	0.28	0.32	1.08
A51	Rectangle	57%	4	4	12	4	12	4	0%	33%	29%	26%	26%	30%	0.28	0.32	1.08
A52	Rectangle	27%	4	4	12	4	12	4	1%	56%	50%	23%	23%	52%	0.28	0.32	1.08
A53	Rectangle	22%	4	4	12	4	12	4	1%	60%	53%	23%	23%	56%	0.28	0.32	1.08
A54	Rectangle	87%	4	4	12	4	12	4	0%	10%	9%	29%	29%	9%	0.28	0.32	1.08
A55	Rectangle	69%	4	4	12	4	12	4	0%	24%	21%	27%	27%	22%	0.28	0.32	1.08
A56	Rectangle	61%	4	4	12	4	12	4	0%	30%	26%	27%	27%	28%	0.28	0.32	1.08
A111	Rectangle	46%	4	4	12	4	12	4	1%	42%	37%	25%	25%	38%	0.28	0.32	1.08
A112	Rectangle	23%	4	4	12	4	12	4	1%	59%	52%	23%	23%	55%	0.28	0.32	1.08
A113	Rectangle	23%	4	4	12	4	12	4	1%	59%	52%	23%	23%	55%	0.28	0.32	1.08
A114	Rectangle	23%	4	4	12	4	12	4	1%	59%	52%	23%	23%	55%	0.28	0.32	1.08
A115	Rectangle	11%	4	4	12	4	12	4	1%	68%	60%	22%	22%	63%	0.28	0.32	1.08
A116	Rectangle	34%	4	4	12	4	12	4	1%	51%	45%	24%	24%	47%	0.28	0.32	1.08
A121	Rectangle	36%	4	4	12	4	12	4	1%	50%	44%	24%	24%	46%	0.28	0.32	1.08
A122	Rectangle	15%	4	4	12	4	12	4	1%	65%	58%	22%	22%	60%	0.28	0.32	1.08
A123	Rectangle	20%	4	4	12	4	12	4	1%	61%	54%	23%	23%	57%	0.28	0.32	1.08
A124	Rectangle	36%	4	4	12	4	12	4	1%	50%	44%	24%	24%	46%	0.28	0.32	1.08
A125	Rectangle	25%	4	4	12	4	12	4	1%	57%	51%	23%	23%	53%	0.28	0.32	1.08
A126	Rectangle	18%	4	4	12	4	12	4	1%	63%	56%	23%	23%	58%	0.28	0.32	1.08
A127	Rectangle	18%	4	4	12	4	12	4	1%	63%	56%	23%	23%	58%	0.28	0.32	1.08
A128	Rectangle	8%	4	4	12	4	12	4	1%	71%	63%	22%	22%	66%	0.28	0.32	1.08
B1	Rectangle-Half S	87%	4	4	12	4	12	4	0%	10%	9%	29%	29%	9%	0.28	0.32	1.08
B2	Rectangle-Half S	58%	4	4	12	4	12	4	0%	32%	28%	26%	26%	30%	0.28	0.32	1.08
B3	Rectangle-Half S	58%	4	4	12	4	12	4	0%	32%	28%	26%	26%	30%	0.28	0.32	1.08
B4	Rectangle-Half S	29%	4	4	12	4	12	4	1%	55%	48%	24%	24%	50%	0.28	0.32	1.08
B5	Rectangle-Half S	29%	4	4	12	4	12	4	1%	55%	48%	24%	24%	50%	0.28	0.32	1.08
B6	Rectangle-Half S	15%	4	4	12	4	12	4	1%	66%	58%	22%	22%	61%	0.28	0.32	1.08
B7	Rectangle-Half S	29%	4	4	12	4	12	4	1%	55%	48%	24%	24%	50%	0.28	0.32	1.08
B8	Rectangle-Half S	44%	4	4	12	4	12	4	1%	43%	38%	25%	25%	40%	0.28	0.32	1.08
B21	Rectangle-Half S	73%	4	4	12	4	12	4	0%	21%	18%	28%	28%	19%	0.28	0.32	1.08
B22	Rectangle-Half S	44%	4	4	12	4	12	4	1%	43%	38%	25%	25%	40%	0.28	0.32	1.08
B23	Rectangle-Half S	15%	4	4	12	4	12	4	1%	66%	58%	22%	22%	61%	0.28	0.32	1.08
B24	Rectangle-Half S	58%	4	4	12	4	12	4	0%	32%	28%	26%	26%	30%	0.28	0.32	1.08
B25	Rectangle-Half S	29%	4	4	12	4	12	4	1%	55%	48%	24%	24%	50%	0.28	0.32	1.08
B26	Rectangle-Half S	44%	4	4	12	4	12	4	1%	43%	38%	25%	25%	40%	0.28	0.32	1.08
B31	Rectangle-Half S	39%	4	4	12	4	12	4	1%	47%	42%	24%	24%	43%	0.28	0.32	1.08
B32	Rectangle-Half S	19%	4	4	12	4	12	4	1%	62%	55%	23%	23%	57%	0.28	0.32	1.08
B33	Rectangle-Half S	39%	4	4	12	4	12	4	1%	47%	42%	24%	24%	43%	0.28	0.32	1.08
B34	Rectangle-Half S	19%	4	4	12	4	12	4	1%	62%	55%	23%	23%	57%	0.28	0.32	1.08
B35	Rectangle-Half S	10%	4	4	12	4	12	4	1%	70%	61%	22%	22%	64%	0.28	0.32	1.08
B36	Rectangle-Half S	32%	4	4	12	4	12	4	1%	53%	47%	24%	24%	49%	0.28	0.32	1.08
C11	Circle	60%	4	4	12	4	12	4	0%	31%	27%	26%	26%	28%	0.28	0.32	1.08
C12	Circle	40%	4	4	12	4	12	4	1%	46%	41%	25%	25%	43%	0.28	0.32	1.08
C13	Circle	20%	4	4	12	4	12	4	1%	62%	54%	23%	23%	57%	0.28	0.32	1.08
C21	Circle	78%	4	4	12	4	12	4	0%	17%	15%	28%	28%	15%	0.28	0.32	1.08
C22	Circle	79%	4	4	12	4	12	4	0%	16%	14%	28%	28%	15%	0.28	0.32	1.08
C23	Circle	42%	4	4	12	4	12	4	1%	44%	39%	25%	25%	41%	0.28	0.32	1.08
C24	Circle	38%	4	4	12	4	12	4	1%	47%	42%	24%	24%	44%	0.28	0.32	1.08
C25	Circle	65%	4	4	12	4	12	4	0%	27%	24%	27%	27%	25%	0.28	0.32	1.08
C31	Circle	70%	4	4	12	4	12	4	0%	23%	20%	27%	27%	21%	0.28	0.32	1.08
C32	Circle	57%	4	4	12	4	12	4	0%	33%	29%	26%	26%	30%	0.28	0.32	1.08
C33	Circle	35%	4	4	12	4	12	4	1%	50%	44%	24%	24%	46%	0.28	0.32	1.08
C34	Circle	63%	4	4	12	4	12	4	0%	29%	25%	27%	27%	26%	0.28	0.32	1.08
C35	Circle	40%	4	4	12	4	12	4	1%	46%	41%	25%	25%	43%	0.28	0.32	1.08
C36	Circle	20%	4	4	12	4	12	4	1%	61%	54%	23%	23%	57%	0.28	0.32	1.08
C41	Circle	52%	4	4	12	4	12	4	0%	37%	33%	26%	26%	34%	0.28	0.32	1.08
C42	Circle	34%	4	4	12	4	12	4	1%	51%	45%	24%	24%	47%	0.28	0.32	1.08
C43	Circle	44%	4	4	12	4	12	4	1%	43%	38%	25%	25%	40%	0.28	0.32	1.08
C51	Circle	54%	4	4	12	4	12	4	0%	36%	31%	26%	26%	33%	0.28	0.32	1.08
C52	Circle	44%	4	4	12	4	12	4	1%	43%	38%	25%	25%	40%	0.28	0.32	1.08
C53	Circle	46%	4	4	12	4	12	4	1%	42%	37%	25%	25%	39%	0.28	0.32	1.08
C54	Circle	49%	4	4	12	4	12	4	1%	39%	35%	25%	25%	36%	0.28	0.32	1.08
C55	Circle	36%	4	4	12	4	12	4	1%	49%	44%	24%	24%	46%	0.28	0.32	1.08
C14	Triangle	51%	4	4	12	4	12	4	0%	38%	33%	26%	26%	35%	0.28	0.32	1.08
C15	Triangle	36%	4	4	12	4	12	4	1%	50%	44%	24%	24%	46%	0.28	0.32	1.08
C16	Triangle	31%	4														

Panel Layers			Layers						UV %	Visible Light Transmittance	Total Solar Transmittance	Visible Reflectance		Solar Heat Gain Coefficient	U-Value (BTU/hrft2F)		Light to Solar Gain
Panel Type	Shape	Cell Coverage Area	Class L1 Thickness	Class L2 Thickness	Spacer Size	Class L3 Thickness	Spacer Size	Class L4 Thickness				Exterior	Interior		Winter Nighttime	Summer Daytime	
C74	Triangle	47%	4	4	12	4	12	4	1%	41%	36%	25%	25%	37%	0.28	0.32	1.08
C75	Triangle	37%	4	4	12	4	12	4	1%	49%	43%	24%	24%	45%	0.28	0.32	1.08
C76	Triangle	41%	4	4	12	4	12	4	1%	45%	40%	25%	25%	42%	0.28	0.32	1.08
C17	Hexagon	48%	4	4	12	4	12	4	1%	40%	35%	25%	25%	37%	0.28	0.32	1.08
C18	Hexagon	32%	4	4	12	4	12	4	1%	52%	46%	24%	24%	48%	0.28	0.32	1.08
C19	Hexagon	16%	4	4	12	4	12	4	1%	65%	57%	22%	22%	60%	0.28	0.32	1.08
C81	Hexagon	68%	4	4	12	4	12	4	0%	25%	22%	27%	27%	23%	0.28	0.32	1.08
C82	Hexagon	36%	4	4	12	4	12	4	1%	49%	43%	24%	24%	45%	0.28	0.32	1.08
C83	Hexagon	36%	4	4	12	4	12	4	1%	49%	43%	24%	24%	45%	0.28	0.32	1.08
C84	Hexagon	52%	4	4	12	4	12	4	0%	37%	32%	26%	26%	34%	0.28	0.32	1.08
C85	Hexagon	22%	4	4	12	4	12	4	1%	60%	53%	23%	23%	56%	0.28	0.32	1.08
C91	Hexagon	69%	4	4	12	4	12	4	0%	24%	21%	27%	27%	22%	0.28	0.32	1.08
C92	Hexagon	53%	4	4	12	4	12	4	0%	36%	32%	26%	26%	33%	0.28	0.32	1.08

Panel Layers			Layers						UV %	Visible Light Transmittance	Total Solar Transmittance	Visible Reflectance		Solar Heat Gain Coefficient	U-Value (BTU/hrft2F)		Light to Solar Gain
LowIron-LowIron-Spacer-LowIron-Spacer-LowIron	Cell Coverage Area	Class L1 Thickness	Class L2 Thickness	Spacer Size	Class L3 Thickness	Spacer Size	Class L4 Thickness	Exterior				Interior	Winter Nighttime		Summer Daytime		
Panel Type	Shape																
Non-Active	Any Shape	0%	6	6	12	6	12	6	0%	77%	66%	21%	21%	70%	0.28	0.32	1.10
A1	Rectangle	92%	6	6	12	6	12	6	0%	6%	5%	29%	29%	6%	0.28	0.32	1.10
A2	Rectangle	61%	6	6	12	6	12	6	0%	30%	26%	27%	27%	27%	0.28	0.32	1.10
A3	Rectangle	61%	6	6	12	6	12	6	0%	30%	26%	27%	27%	27%	0.28	0.32	1.10
A4	Rectangle	31%	6	6	12	6	12	6	0%	53%	46%	24%	24%	49%	0.28	0.32	1.10
A5	Rectangle	31%	6	6	12	6	12	6	0%	53%	46%	24%	24%	49%	0.28	0.32	1.10
A6	Rectangle	15%	6	6	12	6	12	6	0%	65%	56%	22%	22%	59%	0.28	0.32	1.10
A7	Rectangle	31%	6	6	12	6	12	6	0%	53%	46%	24%	24%	49%	0.28	0.32	1.10
A8	Rectangle	46%	6	6	12	6	12	6	0%	42%	36%	25%	25%	38%	0.28	0.32	1.10
A21	Rectangle	76%	6	6	12	6	12	6	0%	18%	16%	28%	28%	16%	0.28	0.32	1.10
A22	Rectangle	38%	6	6	12	6	12	6	0%	48%	41%	24%	24%	43%	0.28	0.32	1.10
A23	Rectangle	15%	6	6	12	6	12	6	0%	65%	56%	22%	22%	59%	0.28	0.32	1.10
A24	Rectangle	46%	6	6	12	6	12	6	0%	42%	36%	25%	25%	38%	0.28	0.32	1.10
A25	Rectangle	31%	6	6	12	6	12	6	0%	53%	46%	24%	24%	49%	0.28	0.32	1.10
A26	Rectangle	15%	6	6	12	6	12	6	0%	65%	56%	22%	22%	59%	0.28	0.32	1.10
A27	Rectangle	23%	6	6	12	6	12	6	0%	59%	51%	23%	23%	54%	0.28	0.32	1.10
A31	Rectangle	31%	6	6	12	6	12	6	0%	53%	46%	24%	24%	49%	0.28	0.32	1.10
A32	Rectangle	20%	6	6	12	6	12	6	0%	61%	53%	23%	23%	56%	0.28	0.32	1.10
A33	Rectangle	10%	6	6	12	6	12	6	0%	69%	59%	22%	22%	63%	0.28	0.32	1.10
A34	Rectangle	5%	6	6	12	6	12	6	0%	73%	63%	21%	21%	66%	0.28	0.32	1.10
A41	Rectangle	74%	6	6	12	6	12	6	0%	20%	17%	28%	28%	18%	0.28	0.32	1.10
A42	Rectangle	47%	6	6	12	6	12	6	0%	41%	35%	25%	25%	37%	0.28	0.32	1.10
A43	Rectangle	14%	6	6	12	6	12	6	0%	66%	57%	22%	22%	60%	0.28	0.32	1.10
A44	Rectangle	10%	6	6	12	6	12	6	0%	69%	59%	22%	22%	63%	0.28	0.32	1.10
A45	Rectangle	43%	6	6	12	6	12	6	0%	44%	37%	25%	25%	40%	0.28	0.32	1.10
A46	Rectangle	60%	6	6	12	6	12	6	0%	31%	26%	26%	26%	28%	0.28	0.32	1.10
A51	Rectangle	57%	6	6	12	6	12	6	0%	33%	28%	26%	26%	30%	0.28	0.32	1.10
A52	Rectangle	27%	6	6	12	6	12	6	0%	56%	48%	23%	23%	51%	0.28	0.32	1.10
A53	Rectangle	22%	6	6	12	6	12	6	0%	60%	52%	23%	23%	55%	0.28	0.32	1.10
A54	Rectangle	87%	6	6	12	6	12	6	0%	10%	9%	29%	29%	9%	0.28	0.32	1.10
A55	Rectangle	69%	6	6	12	6	12	6	0%	24%	21%	27%	27%	22%	0.28	0.32	1.10
A56	Rectangle	61%	6	6	12	6	12	6	0%	30%	26%	27%	27%	27%	0.28	0.32	1.10
A111	Rectangle	46%	6	6	12	6	12	6	0%	42%	36%	25%	25%	38%	0.28	0.32	1.10
A112	Rectangle	23%	6	6	12	6	12	6	0%	59%	51%	23%	23%	54%	0.28	0.32	1.10
A113	Rectangle	23%	6	6	12	6	12	6	0%	59%	51%	23%	23%	54%	0.28	0.32	1.10
A114	Rectangle	23%	6	6	12	6	12	6	0%	59%	51%	23%	23%	54%	0.28	0.32	1.10
A115	Rectangle	11%	6	6	12	6	12	6	0%	68%	58%	22%	22%	62%	0.28	0.32	1.10
A116	Rectangle	34%	6	6	12	6	12	6	0%	51%	43%	24%	24%	46%	0.28	0.32	1.10
A121	Rectangle	36%	6	6	12	6	12	6	0%	50%	42%	24%	24%	45%	0.28	0.32	1.10
A122	Rectangle	15%	6	6	12	6	12	6	0%	65%	56%	22%	22%	59%	0.28	0.32	1.10
A123	Rectangle	20%	6	6	12	6	12	6	0%	61%	53%	23%	23%	56%	0.28	0.32	1.10
A124	Rectangle	36%	6	6	12	6	12	6	0%	50%	42%	24%	24%	45%	0.28	0.32	1.10
A125	Rectangle	25%	6	6	12	6	12	6	0%	57%	49%	23%	23%	52%	0.28	0.32	1.10
A126	Rectangle	18%	6	6	12	6	12	6	0%	63%	54%	23%	23%	58%	0.28	0.32	1.10
A127	Rectangle	18%	6	6	12	6	12	6	0%	63%	54%	23%	23%	58%	0.28	0.32	1.10
A128	Rectangle	8%	6	6	12	6	12	6	0%	71%	61%	22%	22%	65%	0.28	0.32	1.10
B1	Rectangle-Half S	87%	6	6	12	6	12	6	0%	10%	8%	29%	29%	9%	0.28	0.32	1.10
B2	Rectangle-Half S	58%	6	6	12	6	12	6	0%	32%	28%	26%	26%	29%	0.28	0.32	1.10
B3	Rectangle-Half S	58%	6	6	12	6	12	6	0%	32%	28%	26%	26%	29%	0.28	0.32	1.10
B4	Rectangle-Half S	29%	6	6	12	6	12	6	0%	55%	47%	24%	24%	50%	0.28	0.32	1.10
B5	Rectangle-Half S	29%	6	6	12	6	12	6	0%	55%	47%	24%	24%	50%	0.28	0.32	1.10
B6	Rectangle-Half S	15%	6	6	12	6	12	6	0%	66%	56%	22%	22%	60%	0.28	0.32	1.10
B7	Rectangle-Half S	29%	6	6	12	6	12	6	0%	55%	47%	24%	24%	50%	0.28	0.32	1.10
B8	Rectangle-Half S	44%	6	6	12	6	12	6	0%	43%	37%	25%	25%	39%	0.28	0.32	1.10
B21	Rectangle-Half S	73%	6	6	12	6	12	6	0%	21%	18%	28%	28%	19%	0.28	0.32	1.10
B22	Rectangle-Half S	44%	6	6	12	6	12	6	0%	43%	37%	25%	25%	39%	0.28	0.32	1.10
B23	Rectangle-Half S	15%	6	6	12	6	12	6	0%	66%	56%	22%	22%	60%	0.28	0.32	1.10
B24	Rectangle-Half S	58%	6	6	12	6	12	6	0%	32%	28%	26%	26%	29%	0.28	0.32	1.10
B25	Rectangle-Half S	29%	6	6	12	6	12	6	0%	55%	47%	24%	24%	50%	0.28	0.32	1.10
B26	Rectangle-Half S	44%	6	6	12	6	12	6	0%	43%	37%	25%	25%	39%	0.28	0.32	1.10
B31	Rectangle-Half S	39%	6	6	12	6	12	6	0%	47%	40%	24%	24%	43%	0.28	0.32	1.10
B32	Rectangle-Half S	19%	6	6	12	6	12	6	0%	62%	53%	23%	23%	56%	0.28	0.32	1.10
B33	Rectangle-Half S	39%	6	6	12	6	12	6	0%	47%	40%	24%	24%	43%	0.28	0.32	1.10
B34	Rectangle-Half S	19%	6	6	12	6	12	6	0%	62%	53%	23%	23%	56%	0.28	0.32	1.10
B35	Rectangle-Half S	10%	6	6	12	6	12	6	0%	70%	60%	22%	22%	63%	0.28	0.32	1.10
B36	Rectangle-Half S	32%	6	6	12	6	12	6	0%	53%	45%	24%	24%	48%	0.28	0.32	1.10
C11	Circle	60%	6	6	12	6	12	6	0%	31%	26%	26%	26%	28%	0.28	0.32	1.10
C12	Circle	40%	6	6	12	6	12	6	0%	46%	40%	25%	25%	42%	0.28	0.32	1.10
C13	Circle	20%	6	6	12	6	12	6	0%	62%	53%	23%	23%	56%	0.28	0.32	1.10
C21	Circle	78%	6	6	12	6	12	6	0%	17%	14%	28%	28%	15%	0.28	0.32	1.10
C22	Circle	79%	6	6	12	6	12	6	0%	16%	14%	28%	28%	15%	0.28	0.32	1.10
C23	Circle	42%	6	6	12	6	12	6	0%	44%	38%	25%	25%	40%	0.28	0.32	1.10
C24	Circle	38%	6	6	12	6	12	6	0%	47%	41%	24%	24%	43%	0.28	0.32	1.10
C25	Circle	65%	6	6	12	6	12	6	0%	27%	23%	27%	27%	24%	0.28	0.32	1.10
C31	Circle	70%	6	6	12	6	12	6	0%	23%	20%	27%	27%	21%	0.28	0.32	1.10
C32	Circle	57%	6	6	12	6	12	6	0%	33%	28%	26%	26%	30%	0.28	0.32	1.10
C33	Circle	35%	6	6	12	6	12	6	0%	50%	43%	24%	24%	45%	0.28	0.32	1.10
C34	Circle	63%	6	6	12	6	12	6	0%	29%	25%	27%	27%	26%	0.28	0.32	1.10
C35	Circle	40%	6	6	12	6	12	6	0%	46%	40%	25%	25%	42%	0.28	0.32	1.10
C36	Circle	20%	6	6	12	6	12	6	0%	61%	53%	23%	23%	56%	0.28	0.32	1.10
C41	Circle	52%	6	6	12	6	12	6	0%	37%	32%	26%	26%	33%	0.28	0.32	1.10
C42	Circle	34%	6	6	12	6	12	6	0%	51%	43%	24%	24%	46%	0.28	0.32	1.10
C43	Circle	44%	6	6	12	6	12	6	0%	43%	37%	25%	25%	39%	0.28	0.32	1.10
C51	Circle	54%	6	6	12	6	12	6	0%	36%	30%	26%	26%	32%	0.28	0.32	1.10
C52	Circle	44%	6	6	12	6	12	6	0%	43%	37%	25%	25%	39%	0.28	0.32	1.10
C53	Circle	46%	6	6	12	6	12	6	0%	42%	36%	25%	25%	38%	0.28	0.32	1.10
C54	Circle	49%	6	6	12	6	12	6	0%	39%	34%	25%	25%	36%	0.28	0.32	1.10
C55	Circle	36%	6	6	12	6	12	6	0%	49%	42%	24%	24%	45%	0.28	0.32	1.10
C14	Triangle	51%	6	6	12	6	12	6	0%	38%	32%	26%	26%	34%	0.28	0.32	1.10
C15	Triangle	36%	6	6	12	6	12	6	0%	50%	42%	24%	24%	45%	0.28	0.32	1.10
C16	Triangle	31%	6	6	12	6	12	6	0%	53%	46%	24%	24%	49%	0.28</		

Panel Layers			Layers						UV %	Visible Light Transmittance	Total Solar Transmittance	Visible Reflectance		Solar Heat Gain Coefficient	U-Value (BTU/hrft2F)		Light to Solar Gain
Panel Type	Shape	Cell Coverage Area	Glass L1 Thickness	Glass L2 Thickness	Spacer Size	Glass L3 Thickness	Spacer Size	Glass L4 Thickness				Exterior	Interior		Winter Nighttime	Summer Daytime	
C74	Triangle	47%	6	6	12	6	12	6	0%	41%	35%	25%	25%	37%	0.28	0.32	1.10
C75	Triangle	37%	6	6	12	6	12	6	0%	49%	42%	24%	24%	44%	0.28	0.32	1.10
C76	Triangle	41%	6	6	12	6	12	6	0%	45%	39%	25%	25%	41%	0.28	0.32	1.10
C17	Hexagon	48%	6	6	12	6	12	6	0%	40%	34%	25%	25%	36%	0.28	0.32	1.10
C18	Hexagon	32%	6	6	12	6	12	6	0%	52%	45%	24%	24%	47%	0.28	0.32	1.10
C19	Hexagon	16%	6	6	12	6	12	6	0%	65%	55%	22%	22%	59%	0.28	0.32	1.10
C81	Hexagon	68%	6	6	12	6	12	6	0%	25%	21%	27%	27%	22%	0.28	0.32	1.10
C82	Hexagon	36%	6	6	12	6	12	6	0%	49%	42%	24%	24%	44%	0.28	0.32	1.10
C83	Hexagon	36%	6	6	12	6	12	6	0%	49%	42%	24%	24%	44%	0.28	0.32	1.10
C84	Hexagon	52%	6	6	12	6	12	6	0%	37%	32%	26%	26%	33%	0.28	0.32	1.10
C85	Hexagon	22%	6	6	12	6	12	6	0%	60%	52%	23%	23%	55%	0.28	0.32	1.10
C91	Hexagon	69%	6	6	12	6	12	6	0%	24%	20%	27%	27%	22%	0.28	0.32	1.10
C92	Hexagon	53%	6	6	12	6	12	6	0%	36%	31%	26%	26%	33%	0.28	0.32	1.10
C93	Hexagon	37%	6	6	12	6	12	6	0%	48%	41%	24%	24%	44%	0.28	0.32	1.10
C94	Hexagon	10%	6	6	12	6	12	6	0%	69%	59%	22%	22%	63%	0.28	0.32	1.10
C95	Hexagon	32%	6	6	12	6	12	6	0%	53%	45%	24%	24%	48%	0.28	0.32	1.10
C96	Hexagon	47%	6	6	12	6	12	6	0%	41%	35%	25%	25%	37%	0.28	0.32	1.10
C101	Parallelogram	63%	6	6	12	6	12	6	0%	28%	24%	27%	27%	26%	0.28	0.32	1.10
C102	Parallelogram	30%	6	6	12	6	12	6	0%	54%	46%	24%	24%	49%	0.28	0.32	1.10
C103	Parallelogram	37%	6	6	12	6	12	6	0%	49%	42%	24%	24%	44%	0.28	0.32	1.10
C104	Parallelogram	32%	6	6	12	6	12	6	0%	53%	45%	24%	24%	48%	0.28	0.32	1.10
C105	Parallelogram	23%	6	6	12	6	12	6	0%	59%	51%	23%	23%	54%	0.28	0.32	1.10
C106	Parallelogram	50%	6	6	12	6	12	6	0%	39%	33%	25%	25%	35%	0.28	0.32	1.10
C111	Parallelogram	53%	6	6	12	6	12	6	0%	36%	31%	26%	26%	33%	0.28	0.32	1.10
C112	Parallelogram	40%	6	6	12	6	12	6	0%	46%	40%	25%	25%	42%	0.28	0.32	1.10
C113	Parallelogram	43%	6	6	12	6	12	6	0%	44%	37%	25%	25%	40%	0.28	0.32	1.10
C114	Parallelogram	27%	6	6	12	6	12	6	0%	57%	48%	23%	23%	51%	0.28	0.32	1.10
C115	Parallelogram	40%	6	6	12	6	12	6	0%	46%	40%	25%	25%	42%	0.28	0.32	1.10
C116	Parallelogram	27%	6	6	12	6	12	6	0%	57%	48%	23%	23%	51%	0.28	0.32	1.10

Panel Layers				Layers						UV	Visible Light	Total Solar	Visible		Solar Heat	U-Value (BTU/hrft2F)		Light to
LowIron-LowIron-Spacer-LowE Clear-Spacer-LowE Clear				Glass L1	Glass L2	Spacer	Glass L3	Spacer	Glass L4	%	Transmittance	Transmittance	Reflectance		Gain	Winter (Nighttime) / Summer (Daytime)		Solar Gain
Panel Type	Shape	Cell Coverage Area	Thickness	Thickness	Size	Thickness	Size	Thickness				Exterior	Interior	Coefficient				
Non-Active	Any Shape	0%	3	3	12	3	12	3	0%	59%	25%	15%	13%	39%	0.12	0.12	1.51	
A1	Rectangle	92%	3	3	12	3	12	3	0%	29%	2%	29%	29%	3%	0.12	0.12	1.51	
A2	Rectangle	61%	3	3	12	3	12	3	0%	23%	10%	24%	23%	15%	0.12	0.12	1.51	
A3	Rectangle	61%	3	3	12	3	12	3	0%	23%	10%	24%	23%	15%	0.12	0.12	1.51	
A4	Rectangle	31%	3	3	12	3	12	3	0%	41%	17%	20%	18%	27%	0.12	0.12	1.51	
A5	Rectangle	31%	3	3	12	3	12	3	0%	41%	17%	20%	18%	27%	0.12	0.12	1.51	
A6	Rectangle	15%	3	3	12	3	12	3	0%	50%	21%	17%	16%	33%	0.12	0.12	1.51	
A7	Rectangle	31%	3	3	12	3	12	3	0%	41%	17%	20%	18%	27%	0.12	0.12	1.51	
A8	Rectangle	46%	3	3	12	3	12	3	0%	32%	14%	22%	21%	21%	0.12	0.12	1.51	
A21	Rectangle	76%	3	3	12	3	12	3	0%	14%	6%	26%	26%	9%	0.12	0.12	1.51	
A22	Rectangle	38%	3	3	12	3	12	3	0%	36%	15%	21%	19%	24%	0.12	0.12	1.51	
A23	Rectangle	15%	3	3	12	3	12	3	0%	50%	21%	17%	16%	33%	0.12	0.12	1.51	
A24	Rectangle	46%	3	3	12	3	12	3	0%	32%	14%	22%	21%	21%	0.12	0.12	1.51	
A25	Rectangle	31%	3	3	12	3	12	3	0%	41%	17%	20%	18%	27%	0.12	0.12	1.51	
A26	Rectangle	15%	3	3	12	3	12	3	0%	50%	21%	17%	16%	33%	0.12	0.12	1.51	
A27	Rectangle	23%	3	3	12	3	12	3	0%	45%	19%	18%	17%	30%	0.12	0.12	1.51	
A31	Rectangle	31%	3	3	12	3	12	3	0%	41%	17%	20%	18%	27%	0.12	0.12	1.51	
A32	Rectangle	20%	3	3	12	3	12	3	0%	47%	20%	18%	16%	31%	0.12	0.12	1.51	
A33	Rectangle	10%	3	3	12	3	12	3	0%	53%	22%	17%	15%	35%	0.12	0.12	1.51	
A34	Rectangle	5%	3	3	12	3	12	3	0%	56%	24%	16%	14%	37%	0.12	0.12	1.51	
A41	Rectangle	74%	3	3	12	3	12	3	0%	15%	7%	26%	26%	10%	0.12	0.12	1.51	
A42	Rectangle	47%	3	3	12	3	12	3	0%	31%	13%	22%	21%	21%	0.12	0.12	1.51	
A43	Rectangle	14%	3	3	12	3	12	3	0%	51%	21%	17%	15%	34%	0.12	0.12	1.51	
A44	Rectangle	10%	3	3	12	3	12	3	0%	53%	22%	17%	15%	35%	0.12	0.12	1.51	
A45	Rectangle	43%	3	3	12	3	12	3	0%	33%	14%	21%	20%	22%	0.12	0.12	1.51	
A46	Rectangle	60%	3	3	12	3	12	3	0%	24%	10%	24%	23%	16%	0.12	0.12	1.51	
A51	Rectangle	57%	3	3	12	3	12	3	0%	25%	11%	24%	23%	17%	0.12	0.12	1.51	
A52	Rectangle	27%	3	3	12	3	12	3	0%	43%	18%	19%	18%	29%	0.12	0.12	1.51	
A53	Rectangle	22%	3	3	12	3	12	3	0%	46%	20%	18%	17%	31%	0.12	0.12	1.51	
A54	Rectangle	87%	3	3	12	3	12	3	0%	8%	3%	28%	28%	5%	0.12	0.12	1.51	
A55	Rectangle	69%	3	3	12	3	12	3	0%	18%	8%	25%	25%	12%	0.12	0.12	1.51	
A56	Rectangle	61%	3	3	12	3	12	3	0%	23%	10%	24%	23%	15%	0.12	0.12	1.51	
A11	Rectangle	46%	3	3	12	3	12	3	0%	32%	14%	22%	21%	21%	0.12	0.12	1.51	
A112	Rectangle	23%	3	3	12	3	12	3	0%	45%	19%	18%	17%	30%	0.12	0.12	1.51	
A113	Rectangle	23%	3	3	12	3	12	3	0%	45%	19%	18%	17%	30%	0.12	0.12	1.51	
A114	Rectangle	23%	3	3	12	3	12	3	0%	45%	19%	18%	17%	30%	0.12	0.12	1.51	
A115	Rectangle	11%	3	3	12	3	12	3	0%	52%	22%	17%	15%	35%	0.12	0.12	1.51	
A116	Rectangle	34%	3	3	12	3	12	3	0%	39%	16%	20%	19%	26%	0.12	0.12	1.51	
A121	Rectangle	36%	3	3	12	3	12	3	0%	38%	16%	20%	19%	25%	0.12	0.12	1.51	
A122	Rectangle	15%	3	3	12	3	12	3	0%	50%	21%	17%	16%	33%	0.12	0.12	1.51	
A123	Rectangle	20%	3	3	12	3	12	3	0%	47%	20%	18%	16%	31%	0.12	0.12	1.51	
A124	Rectangle	36%	3	3	12	3	12	3	0%	38%	16%	20%	19%	25%	0.12	0.12	1.51	
A125	Rectangle	25%	3	3	12	3	12	3	0%	44%	19%	19%	17%	29%	0.12	0.12	1.51	
A126	Rectangle	18%	3	3	12	3	12	3	0%	48%	21%	18%	16%	32%	0.12	0.12	1.51	
A127	Rectangle	18%	3	3	12	3	12	3	0%	48%	21%	18%	16%	32%	0.12	0.12	1.51	
A128	Rectangle	8%	3	3	12	3	12	3	0%	54%	23%	16%	14%	36%	0.12	0.12	1.51	
B1	Rectangle-Half S	87%	3	3	12	3	12	3	0%	7%	3%	28%	28%	5%	0.12	0.12	1.51	
B2	Rectangle-Half S	58%	3	3	12	3	12	3	0%	25%	10%	24%	23%	16%	0.12	0.12	1.51	
B3	Rectangle-Half S	58%	3	3	12	3	12	3	0%	25%	10%	24%	23%	16%	0.12	0.12	1.51	
B4	Rectangle-Half S	29%	3	3	12	3	12	3	0%	42%	18%	19%	18%	28%	0.12	0.12	1.51	
B5	Rectangle-Half S	29%	3	3	12	3	12	3	0%	42%	18%	19%	18%	28%	0.12	0.12	1.51	
B6	Rectangle-Half S	15%	3	3	12	3	12	3	0%	50%	21%	17%	15%	33%	0.12	0.12	1.51	
B7	Rectangle-Half S	29%	3	3	12	3	12	3	0%	42%	18%	19%	18%	28%	0.12	0.12	1.51	
B8	Rectangle-Half S	44%	3	3	12	3	12	3	0%	33%	14%	22%	20%	22%	0.12	0.12	1.51	
B21	Rectangle-Half S	73%	3	3	12	3	12	3	0%	16%	7%	26%	25%	11%	0.12	0.12	1.51	
B22	Rectangle-Half S	44%	3	3	12	3	12	3	0%	33%	14%	22%	20%	22%	0.12	0.12	1.51	
B23	Rectangle-Half S	15%	3	3	12	3	12	3	0%	50%	21%	17%	15%	33%	0.12	0.12	1.51	
B24	Rectangle-Half S	58%	3	3	12	3	12	3	0%	25%	10%	24%	23%	16%	0.12	0.12	1.51	
B25	Rectangle-Half S	29%	3	3	12	3	12	3	0%	42%	18%	19%	18%	28%	0.12	0.12	1.51	
B26	Rectangle-Half S	44%	3	3	12	3	12	3	0%	33%	14%	22%	20%	22%	0.12	0.12	1.51	
B31	Rectangle-Half S	39%	3	3	12	3	12	3	0%	36%	15%	21%	20%	24%	0.12	0.12	1.51	
B32	Rectangle-Half S	19%	3	3	12	3	12	3	0%	48%	20%	18%	16%	31%	0.12	0.12	1.51	
B33	Rectangle-Half S	39%	3	3	12	3	12	3	0%	36%	15%	21%	20%	24%	0.12	0.12	1.51	
B34	Rectangle-Half S	19%	3	3	12	3	12	3	0%	48%	20%	18%	16%	31%	0.12	0.12	1.51	
B35	Rectangle-Half S	10%	3	3	12	3	12	3	0%	53%	23%	16%	15%	35%	0.12	0.12	1.51	
B36	Rectangle-Half S	32%	3	3	12	3	12	3	0%	40%	17%	20%	18%	27%	0.12	0.12	1.51	
C1	Circle	60%	3	3	12	3	12	3	0%	24%	10%	24%	23%	16%	0.12	0.12	1.51	
C12	Circle	40%	3	3	12	3	12	3	0%	35%	15%	21%	20%	23%	0.12	0.12	1.51	
C13	Circle	20%	3	3	12	3	12	3	0%	47%	20%	18%	16%	31%	0.12	0.12	1.51	
C21	Circle	78%	3	3	12	3	12	3	0%	13%	5%	27%	26%	8%	0.12	0.12	1.51	
C22	Circle	79%	3	3	12	3	12	3	0%	12%	5%	27%	26%	8%	0.12	0.12	1.51	
C23	Circle	42%	3	3	12	3	12	3	0%	34%	14%	21%	20%	22%	0.12	0.12	1.51	
C24	Circle	38%	3	3	12	3	12	3	0%	36%	15%	21%	20%	24%	0.12	0.12	1.51	
C25	Circle	65%	3	3	12	3	12	3	0%	21%	9%	25%	24%	14%	0.12	0.12	1.51	
C31	Circle	70%	3	3	12	3	12	3	0%	18%	7%	26%	25%	12%	0.12	0.12	1.51	
C32	Circle	57%	3	3	12	3	12	3	0%	25%	11%	24%	23%	17%	0.12	0.12	1.51	
C33	Circle	35%	3	3	12	3	12	3	0%	38%	16%	20%	19%	25%	0.12	0.12	1.51	
C34	Circle	63%	3	3	12	3	12	3	0%	22%	9%	24%	24%	15%	0.12	0.12	1.51	
C35	Circle	40%	3	3	12	3	12	3	0%	35%	15%	21%	20%	23%	0.12	0.12	1.51	
C36	Circle	20%	3	3	12	3	12	3	0%	47%	20%	18%	16%	31%	0.12	0.12	1.51	
C41	Circle	52%	3	3	12	3	12	3	0%	28%	12%	23%	22%	19%	0.12	0.12	1.51	
C42	Circle	34%	3	3	12	3	12	3	0%	39%	16%	20%	19%	26%	0.12	0.12	1.51	
C43	Circle	44%	3	3	12	3	12	3	0%	33%	14%	22%	20%	22%	0.12	0.12	1.51	
C51	Circle	54%	3	3	12	3	12	3	0%	27%	12%	23%	22%	18%	0.12	0.12	1.51	
C52	Circle	44%	3	3	12	3	12	3	0%	33%	14%	22%	20%	22%	0.12	0.12	1.51	
C53	Circle	46%	3	3	12	3	12	3	0%	32%	14%	22%	21%	21%	0.12	0.12	1.51	
C54	Circle	49%	3	3	12	3	12	3	0%	30%	13%	22%	21%	20%	0.12	0.12	1.51	
C55	Circle	36%	3	3	12	3	12	3	0%	38%	16%	20%	19%	25%	0.12	0.12	1.51	
C14	Triangle	51%	3	3	12	3	12	3	0%	29%	12%	23%	22%	19%	0.12	0.12	1.51	
C15	Triangle	36%	3	3	12	3	12	3	0%	38%	16%	20%	19%	25%	0.12	0.12	1.51	
C16	Triangle	31%	3	3	12	3	12	3	0%	41%	17%	20%	18%	27%	0.12	0.12	1.51	
C61	Triangle	65%	3	3	12	3	12	3	0%	21%	9%	25%	24%	14%	0.12	0.12		

Panel Layers			Layers						UV %	Visible Light Transmittance	Total Solar Transmittance	Visible Reflectance		Solar Heat Gain Coefficient	U-Value (BTU/hrft2F)		Light to Solar Gain
LowIron-LowIron	Spacer-LowE	Clear-Spacer-LowE	Class L1 Thickness	Class L2 Thickness	Spacer Size	Class L3 Thickness	Spacer Size	Class L4 Thickness				Exterior	Interior		Winter Nighttime	Summer Daytime	
Panel Type	Shape	Cell Coverage Area															
C74	Triangle	47%	3	3	12	3	12	3	0%	31%	13%	22%	21%	21%	0.12	0.12	1.51
C75	Triangle	37%	3	3	12	3	12	3	0%	37%	16%	21%	19%	25%	0.12	0.12	1.51
C76	Triangle	41%	3	3	12	3	12	3	0%	35%	15%	21%	20%	23%	0.12	0.12	1.51
C17	Hexagon	48%	3	3	12	3	12	3	0%	31%	13%	22%	21%	20%	0.12	0.12	1.51
C18	Hexagon	32%	3	3	12	3	12	3	0%	40%	17%	20%	18%	26%	0.12	0.12	1.51
C19	Hexagon	16%	3	3	12	3	12	3	0%	50%	21%	17%	16%	33%	0.12	0.12	1.51
C81	Hexagon	68%	3	3	12	3	12	3	0%	19%	8%	25%	25%	12%	0.12	0.12	1.51
C82	Hexagon	36%	3	3	12	3	12	3	0%	37%	16%	20%	19%	25%	0.12	0.12	1.51
C83	Hexagon	36%	3	3	12	3	12	3	0%	37%	16%	20%	19%	25%	0.12	0.12	1.51
C84	Hexagon	52%	3	3	12	3	12	3	0%	28%	12%	23%	22%	19%	0.12	0.12	1.51
C85	Hexagon	22%	3	3	12	3	12	3	0%	46%	20%	18%	17%	31%	0.12	0.12	1.51
C91	Hexagon	69%	3	3	12	3	12	3	0%	18%	8%	25%	25%	12%	0.12	0.12	1.51
C92	Hexagon	53%	3	3	12	3	12	3	0%	28%	12%	23%	22%	18%	0.12	0.12	1.51
C93	Hexagon	37%	3	3	12	3	12	3	0%	37%	16%	21%	19%	24%	0.12	0.12	1.51
C94	Hexagon	10%	3	3	12	3	12	3	0%	53%	23%	16%	15%	35%	0.12	0.12	1.51
C95	Hexagon	32%	3	3	12	3	12	3	0%	40%	17%	20%	18%	27%	0.12	0.12	1.51
C96	Hexagon	47%	3	3	12	3	12	3	0%	31%	13%	22%	21%	21%	0.12	0.12	1.51
C101	Parallelogram	63%	3	3	12	3	12	3	0%	22%	9%	24%	24%	14%	0.12	0.12	1.51
C102	Parallelogram	30%	3	3	12	3	12	3	0%	41%	18%	19%	18%	27%	0.12	0.12	1.51
C103	Parallelogram	37%	3	3	12	3	12	3	0%	37%	16%	20%	19%	25%	0.12	0.12	1.51
C104	Parallelogram	32%	3	3	12	3	12	3	0%	40%	17%	20%	18%	27%	0.12	0.12	1.51
C105	Parallelogram	23%	3	3	12	3	12	3	0%	45%	19%	18%	17%	30%	0.12	0.12	1.51
C106	Parallelogram	50%	3	3	12	3	12	3	0%	30%	13%	22%	21%	20%	0.12	0.12	1.51
C111	Parallelogram	53%	3	3	12	3	12	3	0%	28%	12%	23%	22%	18%	0.12	0.12	1.51
C112	Parallelogram	40%	3	3	12	3	12	3	0%	35%	15%	21%	20%	23%	0.12	0.12	1.51
C113	Parallelogram	43%	3	3	12	3	12	3	0%	33%	14%	21%	20%	22%	0.12	0.12	1.51
C114	Parallelogram	27%	3	3	12	3	12	3	0%	43%	18%	19%	18%	29%	0.12	0.12	1.51
C115	Parallelogram	40%	3	3	12	3	12	3	0%	35%	15%	21%	20%	23%	0.12	0.12	1.51
C116	Parallelogram	27%	3	3	12	3	12	3	0%	43%	18%	19%	18%	29%	0.12	0.12	1.51

Panel Layers			Layers							UV %	Visible Light Transmittance	Total Solar Transmittance	Visible Reflectance		Solar Heat Gain Coefficient	U-Value (BTU/hrft2F)		Light to Solar Gain
LowIron-LowIron-Spacer-LowEClear-Spacer-LowEClear	Cell Coverage Area	Thickness	Glass L1 Thickness	Glass L2 Thickness	Spacer Size	Glass L3 Thickness	Spacer Size	Glass L4 Thickness	Exterior				Interior	Winter Nighttime		Summer Daytime		
Panel Type	Shape	Area	Thickness	Thickness	Size	Thickness	Size	Thickness	0%	5%	10%	14%	12%	39%	0.12	0.12	1.49	
Non-Active	Any Shape	0%	4	4	12	4	12	4	0%	58%	25%	14%	12%	39%	0.12	0.12	1.49	
A1	Rectangle	92%	4	4	12	4	12	4	0%	5%	2%	29%	29%	3%	0.12	0.12	1.49	
A2	Rectangle	61%	4	4	12	4	12	4	0%	23%	10%	24%	23%	15%	0.12	0.12	1.49	
A3	Rectangle	61%	4	4	12	4	12	4	0%	23%	10%	24%	23%	15%	0.12	0.12	1.49	
A4	Rectangle	31%	4	4	12	4	12	4	0%	40%	17%	19%	18%	27%	0.12	0.12	1.49	
A5	Rectangle	31%	4	4	12	4	12	4	0%	40%	17%	19%	18%	27%	0.12	0.12	1.49	
A6	Rectangle	15%	4	4	12	4	12	4	0%	49%	21%	16%	15%	33%	0.12	0.12	1.49	
A7	Rectangle	31%	4	4	12	4	12	4	0%	40%	17%	19%	18%	27%	0.12	0.12	1.49	
A8	Rectangle	46%	4	4	12	4	12	4	0%	31%	14%	21%	20%	21%	0.12	0.12	1.49	
A21	Rectangle	76%	4	4	12	4	12	4	0%	14%	6%	26%	26%	9%	0.12	0.12	1.49	
A22	Rectangle	38%	4	4	12	4	12	4	0%	36%	15%	20%	19%	24%	0.12	0.12	1.49	
A23	Rectangle	15%	4	4	12	4	12	4	0%	49%	21%	16%	15%	33%	0.12	0.12	1.49	
A24	Rectangle	46%	4	4	12	4	12	4	0%	31%	14%	21%	20%	21%	0.12	0.12	1.49	
A25	Rectangle	31%	4	4	12	4	12	4	0%	40%	17%	19%	18%	27%	0.12	0.12	1.49	
A26	Rectangle	15%	4	4	12	4	12	4	0%	49%	21%	16%	15%	33%	0.12	0.12	1.49	
A27	Rectangle	23%	4	4	12	4	12	4	0%	45%	19%	18%	16%	30%	0.12	0.12	1.49	
A31	Rectangle	31%	4	4	12	4	12	4	0%	40%	17%	19%	18%	27%	0.12	0.12	1.49	
A32	Rectangle	20%	4	4	12	4	12	4	0%	46%	20%	17%	16%	31%	0.12	0.12	1.49	
A33	Rectangle	10%	4	4	12	4	12	4	0%	52%	22%	16%	14%	35%	0.12	0.12	1.49	
A34	Rectangle	5%	4	4	12	4	12	4	0%	55%	24%	15%	13%	37%	0.12	0.12	1.49	
A41	Rectangle	74%	4	4	12	4	12	4	0%	15%	7%	26%	25%	10%	0.12	0.12	1.49	
A42	Rectangle	47%	4	4	12	4	12	4	0%	31%	13%	22%	20%	21%	0.12	0.12	1.49	
A43	Rectangle	14%	4	4	12	4	12	4	0%	50%	21%	16%	15%	34%	0.12	0.12	1.49	
A44	Rectangle	10%	4	4	12	4	12	4	0%	52%	22%	16%	14%	35%	0.12	0.12	1.49	
A45	Rectangle	43%	4	4	12	4	12	4	0%	33%	14%	21%	20%	22%	0.12	0.12	1.49	
A46	Rectangle	60%	4	4	12	4	12	4	0%	23%	10%	24%	23%	16%	0.12	0.12	1.49	
A51	Rectangle	57%	4	4	12	4	12	4	0%	25%	11%	23%	22%	17%	0.12	0.12	1.49	
A52	Rectangle	27%	4	4	12	4	12	4	0%	42%	18%	18%	17%	29%	0.12	0.12	1.49	
A53	Rectangle	22%	4	4	12	4	12	4	0%	45%	20%	17%	16%	31%	0.12	0.12	1.49	
A54	Rectangle	87%	4	4	12	4	12	4	0%	8%	3%	28%	28%	5%	0.12	0.12	1.49	
A55	Rectangle	69%	4	4	12	4	12	4	0%	18%	8%	25%	24%	12%	0.12	0.12	1.49	
A56	Rectangle	61%	4	4	12	4	12	4	0%	23%	10%	24%	23%	15%	0.12	0.12	1.49	
A111	Rectangle	46%	4	4	12	4	12	4	0%	31%	14%	21%	20%	21%	0.12	0.12	1.49	
A112	Rectangle	23%	4	4	12	4	12	4	0%	45%	19%	18%	16%	30%	0.12	0.12	1.49	
A113	Rectangle	23%	4	4	12	4	12	4	0%	45%	19%	18%	16%	30%	0.12	0.12	1.49	
A114	Rectangle	23%	4	4	12	4	12	4	0%	45%	19%	18%	16%	30%	0.12	0.12	1.49	
A115	Rectangle	11%	4	4	12	4	12	4	0%	51%	22%	16%	14%	35%	0.12	0.12	1.49	
A116	Rectangle	34%	4	4	12	4	12	4	0%	38%	16%	20%	18%	26%	0.12	0.12	1.49	
A121	Rectangle	36%	4	4	12	4	12	4	0%	37%	16%	20%	18%	25%	0.12	0.12	1.49	
A122	Rectangle	15%	4	4	12	4	12	4	0%	49%	21%	16%	15%	33%	0.12	0.12	1.49	
A123	Rectangle	20%	4	4	12	4	12	4	0%	46%	20%	17%	16%	31%	0.12	0.12	1.49	
A124	Rectangle	36%	4	4	12	4	12	4	0%	37%	16%	20%	18%	25%	0.12	0.12	1.49	
A125	Rectangle	25%	4	4	12	4	12	4	0%	43%	19%	18%	17%	29%	0.12	0.12	1.49	
A126	Rectangle	18%	4	4	12	4	12	4	0%	48%	21%	17%	15%	32%	0.12	0.12	1.49	
A127	Rectangle	18%	4	4	12	4	12	4	0%	48%	21%	17%	15%	32%	0.12	0.12	1.49	
A128	Rectangle	8%	4	4	12	4	12	4	0%	54%	23%	15%	13%	36%	0.12	0.12	1.49	
B1	Rectangle-Half S	87%	4	4	12	4	12	4	0%	7%	3%	28%	28%	5%	0.12	0.12	1.49	
B2	Rectangle-Half S	58%	4	4	12	4	12	4	0%	24%	10%	23%	22%	16%	0.12	0.12	1.49	
B3	Rectangle-Half S	58%	4	4	12	4	12	4	0%	24%	10%	23%	22%	16%	0.12	0.12	1.49	
B4	Rectangle-Half S	29%	4	4	12	4	12	4	0%	41%	18%	19%	17%	28%	0.12	0.12	1.49	
B5	Rectangle-Half S	29%	4	4	12	4	12	4	0%	41%	18%	19%	17%	28%	0.12	0.12	1.49	
B6	Rectangle-Half S	15%	4	4	12	4	12	4	0%	50%	21%	16%	15%	33%	0.12	0.12	1.49	
B7	Rectangle-Half S	29%	4	4	12	4	12	4	0%	41%	18%	19%	17%	28%	0.12	0.12	1.49	
B8	Rectangle-Half S	44%	4	4	12	4	12	4	0%	33%	14%	21%	20%	22%	0.12	0.12	1.49	
B21	Rectangle-Half S	73%	4	4	12	4	12	4	0%	16%	7%	26%	25%	11%	0.12	0.12	1.49	
B22	Rectangle-Half S	44%	4	4	12	4	12	4	0%	33%	14%	21%	20%	22%	0.12	0.12	1.49	
B23	Rectangle-Half S	15%	4	4	12	4	12	4	0%	50%	21%	16%	15%	33%	0.12	0.12	1.49	
B24	Rectangle-Half S	58%	4	4	12	4	12	4	0%	24%	10%	23%	22%	16%	0.12	0.12	1.49	
B25	Rectangle-Half S	29%	4	4	12	4	12	4	0%	41%	18%	19%	17%	28%	0.12	0.12	1.49	
B26	Rectangle-Half S	44%	4	4	12	4	12	4	0%	33%	14%	21%	20%	22%	0.12	0.12	1.49	
B31	Rectangle-Half S	39%	4	4	12	4	12	4	0%	35%	15%	20%	19%	24%	0.12	0.12	1.49	
B32	Rectangle-Half S	19%	4	4	12	4	12	4	0%	47%	20%	17%	15%	31%	0.12	0.12	1.49	
B33	Rectangle-Half S	39%	4	4	12	4	12	4	0%	35%	15%	20%	19%	24%	0.12	0.12	1.49	
B34	Rectangle-Half S	19%	4	4	12	4	12	4	0%	47%	20%	17%	15%	31%	0.12	0.12	1.49	
B35	Rectangle-Half S	10%	4	4	12	4	12	4	0%	52%	23%	16%	14%	35%	0.12	0.12	1.49	
B36	Rectangle-Half S	32%	4	4	12	4	12	4	0%	40%	17%	19%	18%	27%	0.12	0.12	1.49	
C11	Circle	60%	4	4	12	4	12	4	0%	23%	10%	24%	23%	16%	0.12	0.12	1.49	
C12	Circle	40%	4	4	12	4	12	4	0%	35%	15%	20%	19%	23%	0.12	0.12	1.49	
C13	Circle	20%	4	4	12	4	12	4	0%	46%	20%	17%	16%	31%	0.12	0.12	1.49	
C21	Circle	78%	4	4	12	4	12	4	0%	13%	5%	27%	26%	8%	0.12	0.12	1.49	
C22	Circle	79%	4	4	12	4	12	4	0%	12%	5%	27%	26%	8%	0.12	0.12	1.49	
C23	Circle	42%	4	4	12	4	12	4	0%	33%	14%	21%	20%	22%	0.12	0.12	1.49	
C24	Circle	38%	4	4	12	4	12	4	0%	36%	15%	20%	19%	24%	0.12	0.12	1.49	
C25	Circle	65%	4	4	12	4	12	4	0%	20%	9%	24%	24%	14%	0.12	0.12	1.49	
C31	Circle	70%	4	4	12	4	12	4	0%	17%	7%	25%	25%	12%	0.12	0.12	1.49	
C32	Circle	57%	4	4	12	4	12	4	0%	25%	11%	23%	22%	17%	0.12	0.12	1.49	
C33	Circle	35%	4	4	12	4	12	4	0%	38%	16%	20%	18%	25%	0.12	0.12	1.49	
C34	Circle	63%	4	4	12	4	12	4	0%	22%	9%	24%	23%	15%	0.12	0.12	1.49	
C35	Circle	40%	4	4	12	4	12	4	0%	35%	15%	20%	19%	23%	0.12	0.12	1.49	
C36	Circle	20%	4	4	12	4	12	4	0%	46%	20%	17%	16%	31%	0.12	0.12	1.49	
C41	Circle	52%	4	4	12	4	12	4	0%	28%	12%	22%	21%	19%	0.12	0.12	1.49	
C42	Circle	34%	4	4	12	4	12	4	0%	38%	16%	19%	18%	26%	0.12	0.12	1.49	
C43	Circle	44%	4	4	12	4	12	4	0%	32%	14%	21%	20%	22%	0.12	0.12	1.49	
C51	Circle	54%	4	4	12	4	12	4	0%	27%	12%	23%	22%	18%	0.12	0.12	1.49	
C52	Circle	44%	4	4	12	4	12	4	0%	32%	14%	21%	20%	22%	0.12	0.12	1.49	
C53	Circle	46%	4	4	12	4	12	4	0%	32%	14%	21%	20%	21%	0.12	0.12	1.49	
C54	Circle	49%	4	4	12	4	12	4	0%	30%	13%	22%	21%	20%	0.12	0.12	1.49	
C55	Circle	36%	4	4	12	4	12	4	0%	37%	16%	20%	18%	25%	0.12	0.12	1.49	
C14	Triangle	51%	4	4	12	4	12	4	0%	28%	12%	22%	21%	19%	0.12	0.12	1.49	
C15	Triangle	36%	4	4	12	4	12	4	0%	37%	16%	20%	18%	25%	0.12	0.12	1.49	
C16	Triangle	31%	4	4	12	4	12	4	0									

LLSCSCL4

Panel Layers			Layers						UV %	Visible Light Transmittance	Total Solar Transmittance	Visible Reflectance		Solar Heat Gain Coefficient	U-Value (BTU/hrft2F)		Light to Solar Gain
Panel Type	Shape	Cell Coverage Area	Class L1 Thickness	Class L2 Thickness	Spacer Size	Class L3 Thickness	Spacer Size	Class L4 Thickness				Exterior	Interior		Winter Nighttime	Summer Daytime	
C74	Triangle	47%	4	4	12	4	12	4	0%	31%	13%	22%	21%	21%	0.12	0.12	1.49
C75	Triangle	37%	4	4	12	4	12	4	0%	37%	16%	20%	19%	25%	0.12	0.12	1.49
C76	Triangle	41%	4	4	12	4	12	4	0%	34%	15%	21%	19%	23%	0.12	0.12	1.49
C17	Hexagon	48%	4	4	12	4	12	4	0%	30%	13%	22%	21%	20%	0.12	0.12	1.49
C18	Hexagon	32%	4	4	12	4	12	4	0%	39%	17%	19%	18%	26%	0.12	0.12	1.49
C19	Hexagon	16%	4	4	12	4	12	4	0%	49%	21%	17%	15%	33%	0.12	0.12	1.49
C81	Hexagon	68%	4	4	12	4	12	4	0%	19%	8%	25%	24%	12%	0.12	0.12	1.49
C82	Hexagon	36%	4	4	12	4	12	4	0%	37%	16%	20%	19%	25%	0.12	0.12	1.49
C83	Hexagon	36%	4	4	12	4	12	4	0%	37%	16%	20%	19%	25%	0.12	0.12	1.49
C84	Hexagon	52%	4	4	12	4	12	4	0%	28%	12%	22%	21%	19%	0.12	0.12	1.49
C85	Hexagon	22%	4	4	12	4	12	4	0%	45%	20%	17%	16%	31%	0.12	0.12	1.49
C91	Hexagon	69%	4	4	12	4	12	4	0%	18%	8%	25%	24%	12%	0.12	0.12	1.49
C92	Hexagon	53%	4	4	12	4	12	4	0%	27%	12%	23%	22%	18%	0.12	0.12	1.49

Panel Layers			Layers						UV %	Visible Light Transmittance	Total Solar Transmittance	Visible Reflectance		Solar Heat Gain Coefficient	U-Value (BTU/hrft2F)		Light to Solar Gain
LowIron-LowIron-Spacer-LowE-Clear-Spacer-LowE-Clear	Cell Coverage Area	Thickness	Glass L1 Thickness	Glass L2 Thickness	Spacer Size	Glass L3 Thickness	Spacer Size	Glass L4 Thickness				Exterior	Interior		Winter Nighttime	Summer Daytime	
Panel Type	Shape	Area	Thickness	Thickness	Size	Thickness	Size	Thickness	UV %	Visible Light Transmittance	Total Solar Transmittance	Exterior	Interior	Solar Heat Gain Coefficient	Winter Nighttime	Summer Daytime	Light to Solar Gain
Non-Active	Any Shape	0%	6	6	12	6	12	6	0%	57%	24%	14%	12%	38%	0.12	0.12	1.50
A1	Rectangle	92%	6	6	12	6	12	6	0%	5%	2%	29%	29%	3%	0.12	0.12	1.50
A2	Rectangle	61%	6	6	12	6	12	6	0%	22%	9%	24%	23%	15%	0.12	0.12	1.50
A3	Rectangle	61%	6	6	12	6	12	6	0%	22%	9%	24%	23%	15%	0.12	0.12	1.50
A4	Rectangle	31%	6	6	12	6	12	6	0%	40%	17%	19%	18%	26%	0.12	0.12	1.50
A5	Rectangle	31%	6	6	12	6	12	6	0%	40%	17%	19%	18%	26%	0.12	0.12	1.50
A6	Rectangle	15%	6	6	12	6	12	6	0%	48%	20%	16%	15%	32%	0.12	0.12	1.50
A7	Rectangle	31%	6	6	12	6	12	6	0%	40%	17%	19%	18%	26%	0.12	0.12	1.50
A8	Rectangle	46%	6	6	12	6	12	6	0%	31%	13%	21%	20%	21%	0.12	0.12	1.50
A21	Rectangle	76%	6	6	12	6	12	6	0%	13%	6%	26%	26%	9%	0.12	0.12	1.50
A22	Rectangle	38%	6	6	12	6	12	6	0%	35%	15%	20%	19%	23%	0.12	0.12	1.50
A23	Rectangle	15%	6	6	12	6	12	6	0%	48%	20%	16%	15%	32%	0.12	0.12	1.50
A24	Rectangle	46%	6	6	12	6	12	6	0%	31%	13%	21%	20%	21%	0.12	0.12	1.50
A25	Rectangle	31%	6	6	12	6	12	6	0%	40%	17%	19%	18%	26%	0.12	0.12	1.50
A26	Rectangle	15%	6	6	12	6	12	6	0%	48%	20%	16%	15%	32%	0.12	0.12	1.50
A27	Rectangle	23%	6	6	12	6	12	6	0%	44%	18%	18%	16%	29%	0.12	0.12	1.50
A31	Rectangle	31%	6	6	12	6	12	6	0%	40%	17%	19%	18%	26%	0.12	0.12	1.50
A32	Rectangle	20%	6	6	12	6	12	6	0%	45%	19%	17%	16%	30%	0.12	0.12	1.50
A33	Rectangle	10%	6	6	12	6	12	6	0%	51%	22%	16%	14%	34%	0.12	0.12	1.50
A34	Rectangle	5%	6	6	12	6	12	6	0%	54%	23%	15%	13%	36%	0.12	0.12	1.50
A41	Rectangle	74%	6	6	12	6	12	6	0%	15%	6%	26%	25%	10%	0.12	0.12	1.50
A42	Rectangle	47%	6	6	12	6	12	6	0%	30%	13%	22%	20%	20%	0.12	0.12	1.50
A43	Rectangle	14%	6	6	12	6	12	6	0%	49%	21%	16%	15%	33%	0.12	0.12	1.50
A44	Rectangle	10%	6	6	12	6	12	6	0%	51%	22%	16%	14%	34%	0.12	0.12	1.50
A45	Rectangle	43%	6	6	12	6	12	6	0%	32%	14%	21%	20%	22%	0.12	0.12	1.50
A46	Rectangle	60%	6	6	12	6	12	6	0%	23%	10%	24%	23%	15%	0.12	0.12	1.50
A51	Rectangle	57%	6	6	12	6	12	6	0%	24%	10%	23%	22%	16%	0.12	0.12	1.50
A52	Rectangle	27%	6	6	12	6	12	6	0%	42%	18%	18%	17%	28%	0.12	0.12	1.50
A53	Rectangle	22%	6	6	12	6	12	6	0%	45%	19%	17%	16%	30%	0.12	0.12	1.50
A54	Rectangle	87%	6	6	12	6	12	6	0%	8%	3%	28%	28%	5%	0.12	0.12	1.50
A55	Rectangle	69%	6	6	12	6	12	6	0%	18%	7%	25%	24%	12%	0.12	0.12	1.50
A56	Rectangle	61%	6	6	12	6	12	6	0%	22%	9%	24%	23%	15%	0.12	0.12	1.50
A111	Rectangle	46%	6	6	12	6	12	6	0%	31%	13%	21%	20%	21%	0.12	0.12	1.50
A112	Rectangle	23%	6	6	12	6	12	6	0%	44%	18%	18%	16%	29%	0.12	0.12	1.50
A113	Rectangle	23%	6	6	12	6	12	6	0%	44%	18%	18%	16%	29%	0.12	0.12	1.50
A114	Rectangle	23%	6	6	12	6	12	6	0%	44%	18%	18%	16%	29%	0.12	0.12	1.50
A115	Rectangle	11%	6	6	12	6	12	6	0%	50%	21%	16%	14%	34%	0.12	0.12	1.50
A116	Rectangle	34%	6	6	12	6	12	6	0%	37%	16%	20%	18%	25%	0.12	0.12	1.50
A121	Rectangle	36%	6	6	12	6	12	6	0%	37%	15%	20%	18%	24%	0.12	0.12	1.50
A122	Rectangle	15%	6	6	12	6	12	6	0%	48%	20%	16%	15%	32%	0.12	0.12	1.50
A123	Rectangle	20%	6	6	12	6	12	6	0%	45%	19%	17%	16%	30%	0.12	0.12	1.50
A124	Rectangle	36%	6	6	12	6	12	6	0%	37%	15%	20%	18%	24%	0.12	0.12	1.50
A125	Rectangle	25%	6	6	12	6	12	6	0%	42%	18%	18%	17%	28%	0.12	0.12	1.50
A126	Rectangle	18%	6	6	12	6	12	6	0%	47%	20%	17%	15%	31%	0.12	0.12	1.50
A127	Rectangle	18%	6	6	12	6	12	6	0%	47%	20%	17%	15%	31%	0.12	0.12	1.50
A128	Rectangle	8%	6	6	12	6	12	6	0%	53%	22%	15%	13%	35%	0.12	0.12	1.50
B1	Rectangle-Half S	87%	6	6	12	6	12	6	0%	7%	3%	28%	28%	5%	0.12	0.12	1.50
B2	Rectangle-Half S	58%	6	6	12	6	12	6	0%	24%	10%	23%	22%	16%	0.12	0.12	1.50
B3	Rectangle-Half S	58%	6	6	12	6	12	6	0%	24%	10%	23%	22%	16%	0.12	0.12	1.50
B4	Rectangle-Half S	29%	6	6	12	6	12	6	0%	40%	17%	19%	17%	27%	0.12	0.12	1.50
B5	Rectangle-Half S	29%	6	6	12	6	12	6	0%	40%	17%	19%	17%	27%	0.12	0.12	1.50
B6	Rectangle-Half S	15%	6	6	12	6	12	6	0%	49%	21%	16%	15%	32%	0.12	0.12	1.50
B7	Rectangle-Half S	29%	6	6	12	6	12	6	0%	40%	17%	19%	17%	27%	0.12	0.12	1.50
B8	Rectangle-Half S	44%	6	6	12	6	12	6	0%	32%	14%	21%	20%	21%	0.12	0.12	1.50
B21	Rectangle-Half S	73%	6	6	12	6	12	6	0%	15%	7%	26%	25%	10%	0.12	0.12	1.50
B22	Rectangle-Half S	44%	6	6	12	6	12	6	0%	32%	14%	21%	20%	21%	0.12	0.12	1.50
B23	Rectangle-Half S	15%	6	6	12	6	12	6	0%	49%	21%	16%	15%	32%	0.12	0.12	1.50
B24	Rectangle-Half S	58%	6	6	12	6	12	6	0%	24%	10%	23%	22%	16%	0.12	0.12	1.50
B25	Rectangle-Half S	29%	6	6	12	6	12	6	0%	40%	17%	19%	17%	27%	0.12	0.12	1.50
B26	Rectangle-Half S	44%	6	6	12	6	12	6	0%	32%	14%	21%	20%	21%	0.12	0.12	1.50
B31	Rectangle-Half S	39%	6	6	12	6	12	6	0%	35%	15%	20%	19%	23%	0.12	0.12	1.50
B32	Rectangle-Half S	19%	6	6	12	6	12	6	0%	46%	19%	17%	15%	31%	0.12	0.12	1.50
B33	Rectangle-Half S	39%	6	6	12	6	12	6	0%	35%	15%	20%	19%	23%	0.12	0.12	1.50
B34	Rectangle-Half S	19%	6	6	12	6	12	6	0%	46%	19%	17%	15%	31%	0.12	0.12	1.50
B35	Rectangle-Half S	10%	6	6	12	6	12	6	0%	51%	22%	16%	14%	34%	0.12	0.12	1.50
B36	Rectangle-Half S	32%	6	6	12	6	12	6	0%	39%	16%	19%	18%	26%	0.12	0.12	1.50
C11	Circle	60%	6	6	12	6	12	6	0%	23%	10%	24%	23%	15%	0.12	0.12	1.50
C12	Circle	40%	6	6	12	6	12	6	0%	34%	14%	20%	19%	23%	0.12	0.12	1.50
C13	Circle	20%	6	6	12	6	12	6	0%	46%	19%	17%	16%	30%	0.12	0.12	1.50
C21	Circle	78%	6	6	12	6	12	6	0%	12%	5%	27%	26%	8%	0.12	0.12	1.50
C22	Circle	79%	6	6	12	6	12	6	0%	12%	5%	27%	26%	8%	0.12	0.12	1.50
C23	Circle	42%	6	6	12	6	12	6	0%	33%	14%	21%	20%	22%	0.12	0.12	1.50
C24	Circle	38%	6	6	12	6	12	6	0%	35%	15%	20%	19%	23%	0.12	0.12	1.50
C25	Circle	65%	6	6	12	6	12	6	0%	20%	8%	24%	24%	13%	0.12	0.12	1.50
C31	Circle	70%	6	6	12	6	12	6	0%	17%	7%	25%	25%	11%	0.12	0.12	1.50
C32	Circle	57%	6	6	12	6	12	6	0%	24%	10%	23%	22%	16%	0.12	0.12	1.50
C33	Circle	35%	6	6	12	6	12	6	0%	37%	16%	20%	18%	25%	0.12	0.12	1.50
C34	Circle	63%	6	6	12	6	12	6	0%	21%	9%	24%	23%	14%	0.12	0.12	1.50
C35	Circle	40%	6	6	12	6	12	6	0%	34%	14%	20%	19%	23%	0.12	0.12	1.50
C36	Circle	20%	6	6	12	6	12	6	0%	45%	19%	17%	16%	30%	0.12	0.12	1.50
C41	Circle	52%	6	6	12	6	12	6	0%	27%	11%	22%	21%	18%	0.12	0.12	1.50
C42	Circle	34%	6	6	12	6	12	6	0%	37%	16%	19%	18%	25%	0.12	0.12	1.50
C43	Circle	44%	6	6	12	6	12	6	0%	32%	13%	21%	20%	21%	0.12	0.12	1.50
C51	Circle	54%	6	6	12	6	12	6	0%	26%	11%	23%	22%	18%	0.12	0.12	1.50
C52	Circle	44%	6	6	12	6	12	6	0%	32%	13%	21%	20%	21%	0.12	0.12	1.50
C53	Circle	46%	6	6	12	6	12	6	0%	31%	13%	21%	20%	21%	0.12	0.12	1.50
C54	Circle	49%	6	6	12	6	12	6	0%	29%	12%	22%	21%	19%	0.12	0.12	1.50
C55	Circle	36%	6	6	12	6	12	6	0%	37%	15%	20%	18%	24%	0.12	0.12	1.50
C14	Triangle	51%	6	6	12	6	12	6	0%	28%	12%	22%	21%	19%	0.12	0.12	1.50
C15	Triangle	36%	6	6	12	6	12	6	0%	37%	15%	20%	18%	24%	0.12	0.12	1.50
C16	Triangle	31%	6	6	12	6	12	6	0%</								

Panel Layers			Layers						UV %	Visible Light Transmittance	Total Solar Transmittance	Visible Reflectance		Solar Heat Gain Coefficient	U-Value (BTU/hrft2F)		Light to Solar Gain
Panel Type	Shape	Cell Coverage Area	Class L1 Thickness	Class L2 Thickness	Spacer Size	Class L3 Thickness	Spacer Size	Class L4 Thickness				Exterior	Interior		Winter Nighttime	Summer Daytime	
C74	Triangle	47%	6	6	12	6	12	6	0%	30%	13%	22%	21%	20%	0.12	0.12	1.50
C75	Triangle	37%	6	6	12	6	12	6	0%	36%	15%	20%	19%	24%	0.12	0.12	1.50
C76	Triangle	41%	6	6	12	6	12	6	0%	33%	14%	21%	19%	22%	0.12	0.12	1.50
C17	Hexagon	48%	6	6	12	6	12	6	0%	29%	12%	22%	21%	20%	0.12	0.12	1.50
C18	Hexagon	32%	6	6	12	6	12	6	0%	39%	16%	19%	18%	26%	0.12	0.12	1.50
C19	Hexagon	16%	6	6	12	6	12	6	0%	48%	20%	17%	15%	32%	0.12	0.12	1.50
C81	Hexagon	68%	6	6	12	6	12	6	0%	18%	8%	25%	24%	12%	0.12	0.12	1.50
C82	Hexagon	36%	6	6	12	6	12	6	0%	36%	15%	20%	19%	24%	0.12	0.12	1.50
C83	Hexagon	36%	6	6	12	6	12	6	0%	36%	15%	20%	19%	24%	0.12	0.12	1.50
C84	Hexagon	52%	6	6	12	6	12	6	0%	27%	11%	22%	21%	18%	0.12	0.12	1.50
C85	Hexagon	22%	6	6	12	6	12	6	0%	45%	19%	17%	16%	30%	0.12	0.12	1.50
C91	Hexagon	69%	6	6	12	6	12	6	0%	18%	7%	25%	24%	12%	0.12	0.12	1.50
C92	Hexagon	53%	6	6	12	6	12	6	0%	27%	11%	23%	22%	18%	0.12	0.12	1.50
C93	Hexagon	37%	6	6	12	6	12	6	0%	36%	15%	20%	19%	24%	0.12	0.12	1.50
C94	Hexagon	10%	6	6	12	6	12	6	0%	51%	22%	16%	14%	34%	0.12	0.12	1.50
C95	Hexagon	32%	6	6	12	6	12	6	0%	39%	16%	19%	18%	26%	0.12	0.12	1.50
C96	Hexagon	47%	6	6	12	6	12	6	0%	30%	13%	22%	21%	20%	0.12	0.12	1.50
C101	Parallelogram	63%	6	6	12	6	12	6	0%	21%	9%	24%	23%	14%	0.12	0.12	1.50
C102	Parallelogram	30%	6	6	12	6	12	6	0%	40%	17%	19%	17%	27%	0.12	0.12	1.50
C103	Parallelogram	37%	6	6	12	6	12	6	0%	36%	15%	20%	19%	24%	0.12	0.12	1.50
C104	Parallelogram	32%	6	6	12	6	12	6	0%	39%	16%	19%	18%	26%	0.12	0.12	1.50
C105	Parallelogram	23%	6	6	12	6	12	6	0%	44%	18%	18%	16%	29%	0.12	0.12	1.50
C106	Parallelogram	50%	6	6	12	6	12	6	0%	29%	12%	22%	21%	19%	0.12	0.12	1.50
C111	Parallelogram	53%	6	6	12	6	12	6	0%	27%	11%	23%	22%	18%	0.12	0.12	1.50
C112	Parallelogram	40%	6	6	12	6	12	6	0%	34%	14%	20%	19%	23%	0.12	0.12	1.50
C113	Parallelogram	43%	6	6	12	6	12	6	0%	32%	14%	21%	20%	22%	0.12	0.12	1.50
C114	Parallelogram	27%	6	6	12	6	12	6	0%	42%	18%	18%	17%	28%	0.12	0.12	1.50
C115	Parallelogram	40%	6	6	12	6	12	6	0%	34%	14%	20%	19%	23%	0.12	0.12	1.50
C116	Parallelogram	27%	6	6	12	6	12	6	0%	42%	18%	18%	17%	28%	0.12	0.12	1.50

Panel Layers				Layers								UV %	Visible Light Transmittance	Total Solar Transmittance	Visible Reflectance		Solar Heat Gain Coefficient	U-Value (BTU/hrft2F)		Light to Solar Gain
LowIron-LowIron-Spacer-LowIron-Spacer-LowIron-LowIron				Class L1 Thickness	Class L2 Thickness	Spacer Size	Class L3 Thickness	Spacer Size	Class L4 Thickness	Exterior	Interior				Winter Nighttime	Summer Daytime				
Panel Type	Shape	Cell Coverage Area																		
Non-Active	Any Shape	0%	3	3	12	3	12	3	0%	61%	27%	15%	13%	40%	0.12	0.12	1.53			
A1	Rectangle	92%	3	3	12	3	12	3	0%	9%	2%	29%	29%	3%	0.12	0.12	1.53			
A2	Rectangle	61%	3	3	12	3	12	3	0%	24%	10%	24%	23%	16%	0.12	0.12	1.53			
A3	Rectangle	61%	3	3	12	3	12	3	0%	24%	10%	24%	23%	16%	0.12	0.12	1.53			
A4	Rectangle	31%	3	3	12	3	12	3	0%	42%	19%	20%	18%	28%	0.12	0.12	1.53			
A5	Rectangle	31%	3	3	12	3	12	3	0%	42%	19%	20%	18%	28%	0.12	0.12	1.53			
A6	Rectangle	15%	3	3	12	3	12	3	0%	52%	23%	17%	16%	34%	0.12	0.12	1.53			
A7	Rectangle	31%	3	3	12	3	12	3	0%	42%	19%	20%	18%	28%	0.12	0.12	1.53			
A8	Rectangle	46%	3	3	12	3	12	3	0%	33%	15%	22%	21%	22%	0.12	0.12	1.53			
A21	Rectangle	76%	3	3	12	3	12	3	0%	14%	6%	26%	26%	9%	0.12	0.12	1.53			
A22	Rectangle	38%	3	3	12	3	12	3	0%	38%	17%	21%	19%	25%	0.12	0.12	1.53			
A23	Rectangle	15%	3	3	12	3	12	3	0%	52%	23%	17%	16%	34%	0.12	0.12	1.53			
A24	Rectangle	46%	3	3	12	3	12	3	0%	33%	15%	22%	21%	22%	0.12	0.12	1.53			
A25	Rectangle	31%	3	3	12	3	12	3	0%	42%	19%	20%	18%	28%	0.12	0.12	1.53			
A26	Rectangle	15%	3	3	12	3	12	3	0%	52%	23%	17%	16%	34%	0.12	0.12	1.53			
A27	Rectangle	23%	3	3	12	3	12	3	0%	47%	21%	18%	17%	31%	0.12	0.12	1.53			
A31	Rectangle	31%	3	3	12	3	12	3	0%	42%	19%	20%	18%	28%	0.12	0.12	1.53			
A32	Rectangle	20%	3	3	12	3	12	3	0%	49%	21%	18%	16%	32%	0.12	0.12	1.53			
A33	Rectangle	10%	3	3	12	3	12	3	0%	55%	24%	17%	15%	36%	0.12	0.12	1.53			
A34	Rectangle	5%	3	3	12	3	12	3	0%	58%	26%	16%	14%	38%	0.12	0.12	1.53			
A41	Rectangle	74%	3	3	12	3	12	3	0%	16%	7%	26%	26%	10%	0.12	0.12	1.53			
A42	Rectangle	47%	3	3	12	3	12	3	0%	32%	14%	22%	21%	21%	0.12	0.12	1.53			
A43	Rectangle	14%	3	3	12	3	12	3	0%	52%	23%	17%	15%	34%	0.12	0.12	1.53			
A44	Rectangle	10%	3	3	12	3	12	3	0%	55%	24%	17%	15%	36%	0.12	0.12	1.53			
A45	Rectangle	43%	3	3	12	3	12	3	0%	35%	15%	21%	20%	23%	0.12	0.12	1.53			
A46	Rectangle	60%	3	3	12	3	12	3	0%	24%	11%	24%	23%	16%	0.12	0.12	1.53			
A51	Rectangle	57%	3	3	12	3	12	3	0%	26%	12%	24%	23%	17%	0.12	0.12	1.53			
A52	Rectangle	27%	3	3	12	3	12	3	0%	45%	20%	19%	18%	29%	0.12	0.12	1.53			
A53	Rectangle	22%	3	3	12	3	12	3	0%	48%	21%	18%	17%	31%	0.12	0.12	1.53			
A54	Rectangle	87%	3	3	12	3	12	3	0%	8%	4%	28%	28%	5%	0.12	0.12	1.53			
A55	Rectangle	69%	3	3	12	3	12	3	0%	19%	8%	25%	25%	12%	0.12	0.12	1.53			
A56	Rectangle	61%	3	3	12	3	12	3	0%	24%	10%	24%	23%	16%	0.12	0.12	1.53			
A111	Rectangle	46%	3	3	12	3	12	3	0%	33%	15%	22%	21%	22%	0.12	0.12	1.53			
A112	Rectangle	23%	3	3	12	3	12	3	0%	47%	21%	18%	17%	31%	0.12	0.12	1.53			
A113	Rectangle	23%	3	3	12	3	12	3	0%	47%	21%	18%	17%	31%	0.12	0.12	1.53			
A114	Rectangle	23%	3	3	12	3	12	3	0%	47%	21%	18%	17%	31%	0.12	0.12	1.53			
A115	Rectangle	11%	3	3	12	3	12	3	0%	54%	24%	17%	15%	35%	0.12	0.12	1.53			
A116	Rectangle	34%	3	3	12	3	12	3	0%	40%	18%	20%	19%	26%	0.12	0.12	1.53			
A121	Rectangle	36%	3	3	12	3	12	3	0%	39%	17%	20%	19%	26%	0.12	0.12	1.53			
A122	Rectangle	15%	3	3	12	3	12	3	0%	52%	23%	17%	16%	34%	0.12	0.12	1.53			
A123	Rectangle	20%	3	3	12	3	12	3	0%	49%	21%	18%	16%	32%	0.12	0.12	1.53			
A124	Rectangle	36%	3	3	12	3	12	3	0%	39%	17%	20%	19%	26%	0.12	0.12	1.53			
A125	Rectangle	25%	3	3	12	3	12	3	0%	45%	20%	19%	17%	30%	0.12	0.12	1.53			
A126	Rectangle	18%	3	3	12	3	12	3	0%	50%	22%	18%	16%	33%	0.12	0.12	1.53			
A127	Rectangle	18%	3	3	12	3	12	3	0%	50%	22%	18%	16%	33%	0.12	0.12	1.53			
A128	Rectangle	8%	3	3	12	3	12	3	0%	56%	25%	16%	14%	37%	0.12	0.12	1.53			
B1	Rectangle-Half S	87%	3	3	12	3	12	3	0%	8%	3%	28%	28%	5%	0.12	0.12	1.53			
B2	Rectangle-Half S	58%	3	3	12	3	12	3	0%	25%	11%	24%	23%	17%	0.12	0.12	1.53			
B3	Rectangle-Half S	58%	3	3	12	3	12	3	0%	25%	11%	24%	23%	17%	0.12	0.12	1.53			
B4	Rectangle-Half S	29%	3	3	12	3	12	3	0%	43%	19%	19%	18%	28%	0.12	0.12	1.53			
B5	Rectangle-Half S	29%	3	3	12	3	12	3	0%	43%	19%	19%	18%	28%	0.12	0.12	1.53			
B6	Rectangle-Half S	15%	3	3	12	3	12	3	0%	52%	23%	17%	15%	34%	0.12	0.12	1.53			
B7	Rectangle-Half S	29%	3	3	12	3	12	3	0%	43%	19%	19%	18%	28%	0.12	0.12	1.53			
B8	Rectangle-Half S	44%	3	3	12	3	12	3	0%	34%	15%	22%	20%	23%	0.12	0.12	1.53			
B21	Rectangle-Half S	73%	3	3	12	3	12	3	0%	17%	7%	26%	25%	11%	0.12	0.12	1.53			
B22	Rectangle-Half S	44%	3	3	12	3	12	3	0%	34%	15%	22%	20%	23%	0.12	0.12	1.53			
B23	Rectangle-Half S	15%	3	3	12	3	12	3	0%	52%	23%	17%	15%	34%	0.12	0.12	1.53			
B24	Rectangle-Half S	58%	3	3	12	3	12	3	0%	25%	11%	24%	23%	17%	0.12	0.12	1.53			
B25	Rectangle-Half S	29%	3	3	12	3	12	3	0%	43%	19%	19%	18%	28%	0.12	0.12	1.53			
B26	Rectangle-Half S	44%	3	3	12	3	12	3	0%	34%	15%	22%	20%	23%	0.12	0.12	1.53			
B31	Rectangle-Half S	39%	3	3	12	3	12	3	0%	37%	17%	21%	20%	24%	0.12	0.12	1.53			
B32	Rectangle-Half S	19%	3	3	12	3	12	3	0%	49%	22%	18%	16%	32%	0.12	0.12	1.53			
B33	Rectangle-Half S	39%	3	3	12	3	12	3	0%	37%	17%	21%	20%	24%	0.12	0.12	1.53			
B34	Rectangle-Half S	19%	3	3	12	3	12	3	0%	49%	22%	18%	16%	32%	0.12	0.12	1.53			
B35	Rectangle-Half S	10%	3	3	12	3	12	3	0%	55%	24%	16%	15%	36%	0.12	0.12	1.53			
B36	Rectangle-Half S	32%	3	3	12	3	12	3	0%	42%	18%	20%	18%	27%	0.12	0.12	1.53			
C11	Circle	60%	3	3	12	3	12	3	0%	24%	11%	24%	23%	16%	0.12	0.12	1.53			
C12	Circle	40%	3	3	12	3	12	3	0%	37%	16%	21%	20%	24%	0.12	0.12	1.53			
C13	Circle	20%	3	3	12	3	12	3	0%	49%	22%	18%	16%	32%	0.12	0.12	1.53			
C21	Circle	78%	3	3	12	3	12	3	0%	13%	6%	27%	26%	9%	0.12	0.12	1.53			
C22	Circle	79%	3	3	12	3	12	3	0%	13%	6%	27%	26%	8%	0.12	0.12	1.53			
C23	Circle	42%	3	3	12	3	12	3	0%	35%	16%	21%	20%	23%	0.12	0.12	1.53			
C24	Circle	38%	3	3	12	3	12	3	0%	38%	17%	21%	20%	25%	0.12	0.12	1.53			
C25	Circle	65%	3	3	12	3	12	3	0%	21%	9%	25%	24%	14%	0.12	0.12	1.53			
C31	Circle	70%	3	3	12	3	12	3	0%	18%	8%	26%	25%	12%	0.12	0.12	1.53			
C32	Circle	57%	3	3	12	3	12	3	0%	26%	12%	24%	23%	17%	0.12	0.12	1.53			
C33	Circle	35%	3	3	12	3	12	3	0%	40%	18%	20%	19%	26%	0.12	0.12	1.53			
C34	Circle	63%	3	3	12	3	12	3	0%	23%	10%	24%	24%	15%	0.12	0.12	1.53			
C35	Circle	40%	3	3	12	3	12	3	0%	37%	16%	21%	20%	24%	0.12	0.12	1.53			
C36	Circle	20%	3	3	12	3	12	3	0%	49%	22%	18%	16%	32%	0.12	0.12	1.53			
C41	Circle	52%	3	3	12	3	12	3	0%	29%	13%	23%	22%	19%	0.12	0.12	1.53			
C42	Circle	34%	3	3	12	3	12	3	0%	40%	18%	20%	19%	26%	0.12	0.12	1.53			
C43	Circle	44%	3	3	12	3	12	3	0%	34%	15%	22%	20%	22%	0.12	0.12	1.53			
C51	Circle	54%	3	3	12	3	12	3	0%	28%	12%	23%	22%	18%	0.12	0.12	1.53			
C52	Circle	44%	3	3	12	3	12	3	0%	34%	15%	22%	20%	22%	0.12	0.12	1.53			
C53	Circle	46%	3	3	12	3	12	3	0%	33%	15%	22%	21%	22%	0.12	0.12	1.53			
C54	Circle	49%	3	3	12	3	12	3	0%	31%	14%	22%	21%	20%	0.12	0.12	1.53			
C55	Circle	36%	3	3	12	3	12	3	0%	39%	17%	20%	19%	26%	0.12	0.12	1.53			
C14	Triangle	51%	3	3	12	3	12	3	0%	30%	13%	23%	22%	20%	0.12	0.12	1.53			
C15	Triangle	36%	3	3	12	3	12	3	0%	39%	17%	20%	19%	26%	0.12	0.12	1.53			
C16	Triangle	31%	3	3	12	3	12	3	0%	42%	19%	20%	18%	28%	0.12	0.12	1.53			
C61	Triangle	65%	3	3	12	3	12	3	0%	21%	9%	25%	24%	14%	0.12	0.12				

Panel Layers			Layers						UV %	Visible Light Transmittance	Total Solar Transmittance	Visible Reflectance		Solar Heat Gain Coefficient	U-Value (BTU/hrft2F)		Light to Solar Gain
Panel Type	Shape	Cell Coverage Area	Glass L1 Thickness	Glass L2 Thickness	Spacer Size	Glass L3 Thickness	Spacer Size	Glass L4 Thickness				Exterior	Interior		Winter Nighttime	Summer Daytime	
C74	Triangle	47%	3	3	12	3	12	3	0%	32%	14%	22%	21%	21%	0.12	0.12	1.53
C75	Triangle	37%	3	3	12	3	12	3	0%	38%	17%	21%	19%	25%	0.12	0.12	1.53
C76	Triangle	41%	3	3	12	3	12	3	0%	36%	16%	21%	20%	23%	0.12	0.12	1.53
C17	Hexagon	48%	3	3	12	3	12	3	0%	32%	14%	22%	21%	21%	0.12	0.12	1.53
C18	Hexagon	32%	3	3	12	3	12	3	0%	41%	18%	20%	18%	27%	0.12	0.12	1.53
C19	Hexagon	16%	3	3	12	3	12	3	0%	51%	23%	17%	16%	34%	0.12	0.12	1.53
C81	Hexagon	68%	3	3	12	3	12	3	0%	20%	9%	25%	25%	13%	0.12	0.12	1.53
C82	Hexagon	36%	3	3	12	3	12	3	0%	39%	17%	20%	19%	25%	0.12	0.12	1.53
C83	Hexagon	36%	3	3	12	3	12	3	0%	39%	17%	20%	19%	25%	0.12	0.12	1.53
C84	Hexagon	52%	3	3	12	3	12	3	0%	29%	13%	23%	22%	19%	0.12	0.12	1.53
C85	Hexagon	22%	3	3	12	3	12	3	0%	48%	21%	18%	17%	31%	0.12	0.12	1.53
C91	Hexagon	69%	3	3	12	3	12	3	0%	19%	8%	25%	25%	12%	0.12	0.12	1.53
C92	Hexagon	53%	3	3	12	3	12	3	0%	29%	13%	23%	22%	19%	0.12	0.12	1.53
C93	Hexagon	37%	3	3	12	3	12	3	0%	38%	17%	21%	19%	25%	0.12	0.12	1.53
C94	Hexagon	10%	3	3	12	3	12	3	0%	55%	24%	16%	15%	36%	0.12	0.12	1.53
C95	Hexagon	32%	3	3	12	3	12	3	0%	42%	18%	20%	18%	27%	0.12	0.12	1.53
C96	Hexagon	47%	3	3	12	3	12	3	0%	32%	14%	22%	21%	21%	0.12	0.12	1.53
C101	Parallelogram	63%	3	3	12	3	12	3	0%	22%	10%	24%	24%	15%	0.12	0.12	1.53
C102	Parallelogram	30%	3	3	12	3	12	3	0%	43%	19%	19%	18%	28%	0.12	0.12	1.53
C103	Parallelogram	37%	3	3	12	3	12	3	0%	39%	17%	20%	19%	25%	0.12	0.12	1.53
C104	Parallelogram	32%	3	3	12	3	12	3	0%	42%	18%	20%	18%	27%	0.12	0.12	1.53
C105	Parallelogram	23%	3	3	12	3	12	3	0%	47%	21%	18%	17%	31%	0.12	0.12	1.53
C106	Parallelogram	50%	3	3	12	3	12	3	0%	31%	14%	22%	21%	20%	0.12	0.12	1.53
C111	Parallelogram	53%	3	3	12	3	12	3	0%	29%	13%	23%	22%	19%	0.12	0.12	1.53
C112	Parallelogram	40%	3	3	12	3	12	3	0%	37%	16%	21%	20%	24%	0.12	0.12	1.53
C113	Parallelogram	43%	3	3	12	3	12	3	0%	35%	15%	21%	20%	23%	0.12	0.12	1.53
C114	Parallelogram	27%	3	3	12	3	12	3	0%	45%	20%	19%	18%	29%	0.12	0.12	1.53
C115	Parallelogram	40%	3	3	12	3	12	3	0%	37%	16%	21%	20%	24%	0.12	0.12	1.53
C116	Parallelogram	27%	3	3	12	3	12	3	0%	45%	20%	19%	18%	29%	0.12	0.12	1.53

Panel Layers			Layers								UV %	Visible Light Transmittance	Total Solar Transmittance	Visible Reflectance		Solar Heat Gain Coefficient	U-Value (BTU/hrft2F)		Light to Solar Gain
Panel Type	Shape	Cell Coverage Area	Glass L1 Thickness	Glass L2 Thickness	Spacer Size	Glass L3 Thickness	Spacer Size	Glass L4 Thickness	Exterior	Interior				Winter Nighttime	Summer Daytime				
																	Solar Heat Gain Coefficient	Winter Nighttime	
Non-Active	Any Shape	0%	4	4	12	4	12	4	0%	61%	27%	15%	13%	40%	0.12	0.12	1.53		
A1	Rectangle	92%	4	4	12	4	12	4	0%	5%	2%	29%	29%	3%	0.12	0.12	1.53		
A2	Rectangle	61%	4	4	12	4	12	4	0%	24%	10%	24%	23%	16%	0.12	0.12	1.53		
A3	Rectangle	61%	4	4	12	4	12	4	0%	24%	10%	24%	23%	16%	0.12	0.12	1.53		
A4	Rectangle	31%	4	4	12	4	12	4	0%	42%	19%	20%	18%	28%	0.12	0.12	1.53		
A5	Rectangle	31%	4	4	12	4	12	4	0%	42%	19%	20%	18%	28%	0.12	0.12	1.53		
A6	Rectangle	15%	4	4	12	4	12	4	0%	52%	23%	17%	16%	34%	0.12	0.12	1.53		
A7	Rectangle	31%	4	4	12	4	12	4	0%	42%	19%	20%	18%	28%	0.12	0.12	1.53		
A8	Rectangle	46%	4	4	12	4	12	4	0%	33%	15%	22%	21%	22%	0.12	0.12	1.53		
A21	Rectangle	76%	4	4	12	4	12	4	0%	14%	6%	26%	26%	9%	0.12	0.12	1.53		
A22	Rectangle	38%	4	4	12	4	12	4	0%	38%	17%	21%	19%	25%	0.12	0.12	1.53		
A23	Rectangle	15%	4	4	12	4	12	4	0%	52%	23%	17%	16%	34%	0.12	0.12	1.53		
A24	Rectangle	46%	4	4	12	4	12	4	0%	33%	15%	22%	21%	22%	0.12	0.12	1.53		
A25	Rectangle	31%	4	4	12	4	12	4	0%	42%	19%	20%	18%	28%	0.12	0.12	1.53		
A26	Rectangle	15%	4	4	12	4	12	4	0%	52%	23%	17%	16%	34%	0.12	0.12	1.53		
A27	Rectangle	23%	4	4	12	4	12	4	0%	47%	21%	18%	17%	31%	0.12	0.12	1.53		
A31	Rectangle	31%	4	4	12	4	12	4	0%	42%	19%	20%	18%	28%	0.12	0.12	1.53		
A32	Rectangle	20%	4	4	12	4	12	4	0%	49%	21%	18%	16%	32%	0.12	0.12	1.53		
A33	Rectangle	10%	4	4	12	4	12	4	0%	55%	24%	17%	15%	36%	0.12	0.12	1.53		
A34	Rectangle	5%	4	4	12	4	12	4	0%	58%	26%	16%	14%	38%	0.12	0.12	1.53		
A41	Rectangle	74%	4	4	12	4	12	4	0%	16%	7%	26%	26%	10%	0.12	0.12	1.53		
A42	Rectangle	47%	4	4	12	4	12	4	0%	32%	14%	22%	21%	21%	0.12	0.12	1.53		
A43	Rectangle	14%	4	4	12	4	12	4	0%	52%	23%	17%	15%	34%	0.12	0.12	1.53		
A44	Rectangle	10%	4	4	12	4	12	4	0%	55%	24%	17%	15%	36%	0.12	0.12	1.53		
A45	Rectangle	43%	4	4	12	4	12	4	0%	35%	15%	21%	20%	23%	0.12	0.12	1.53		
A46	Rectangle	60%	4	4	12	4	12	4	0%	24%	11%	24%	23%	16%	0.12	0.12	1.53		
A51	Rectangle	57%	4	4	12	4	12	4	0%	26%	12%	24%	23%	17%	0.12	0.12	1.53		
A52	Rectangle	27%	4	4	12	4	12	4	0%	45%	20%	19%	18%	29%	0.12	0.12	1.53		
A53	Rectangle	22%	4	4	12	4	12	4	0%	48%	21%	18%	17%	31%	0.12	0.12	1.53		
A54	Rectangle	87%	4	4	12	4	12	4	0%	8%	4%	28%	28%	5%	0.12	0.12	1.53		
A55	Rectangle	69%	4	4	12	4	12	4	0%	19%	8%	25%	25%	12%	0.12	0.12	1.53		
A56	Rectangle	61%	4	4	12	4	12	4	0%	24%	10%	24%	23%	16%	0.12	0.12	1.53		
A111	Rectangle	46%	4	4	12	4	12	4	0%	33%	15%	22%	21%	22%	0.12	0.12	1.53		
A112	Rectangle	23%	4	4	12	4	12	4	0%	47%	21%	18%	17%	31%	0.12	0.12	1.53		
A113	Rectangle	23%	4	4	12	4	12	4	0%	47%	21%	18%	17%	31%	0.12	0.12	1.53		
A114	Rectangle	23%	4	4	12	4	12	4	0%	47%	21%	18%	17%	31%	0.12	0.12	1.53		
A115	Rectangle	11%	4	4	12	4	12	4	0%	54%	24%	17%	15%	35%	0.12	0.12	1.53		
A116	Rectangle	34%	4	4	12	4	12	4	0%	40%	18%	20%	19%	26%	0.12	0.12	1.53		
A121	Rectangle	36%	4	4	12	4	12	4	0%	39%	17%	20%	19%	26%	0.12	0.12	1.53		
A122	Rectangle	15%	4	4	12	4	12	4	0%	52%	23%	17%	16%	34%	0.12	0.12	1.53		
A123	Rectangle	20%	4	4	12	4	12	4	0%	49%	21%	18%	16%	32%	0.12	0.12	1.53		
A124	Rectangle	36%	4	4	12	4	12	4	0%	39%	17%	20%	19%	26%	0.12	0.12	1.53		
A125	Rectangle	25%	4	4	12	4	12	4	0%	45%	20%	19%	17%	30%	0.12	0.12	1.53		
A126	Rectangle	18%	4	4	12	4	12	4	0%	50%	22%	18%	16%	33%	0.12	0.12	1.53		
A127	Rectangle	18%	4	4	12	4	12	4	0%	50%	22%	18%	16%	33%	0.12	0.12	1.53		
A128	Rectangle	8%	4	4	12	4	12	4	0%	56%	25%	16%	14%	37%	0.12	0.12	1.53		
B1	Rectangle-Half S	87%	4	4	12	4	12	4	0%	8%	3%	28%	28%	5%	0.12	0.12	1.53		
B2	Rectangle-Half S	58%	4	4	12	4	12	4	0%	25%	11%	24%	23%	17%	0.12	0.12	1.53		
B3	Rectangle-Half S	58%	4	4	12	4	12	4	0%	25%	11%	24%	23%	17%	0.12	0.12	1.53		
B4	Rectangle-Half S	29%	4	4	12	4	12	4	0%	43%	19%	19%	18%	28%	0.12	0.12	1.53		
B5	Rectangle-Half S	29%	4	4	12	4	12	4	0%	43%	19%	19%	18%	28%	0.12	0.12	1.53		
B6	Rectangle-Half S	15%	4	4	12	4	12	4	0%	52%	23%	17%	15%	34%	0.12	0.12	1.53		
B7	Rectangle-Half S	29%	4	4	12	4	12	4	0%	43%	19%	19%	18%	28%	0.12	0.12	1.53		
B8	Rectangle-Half S	44%	4	4	12	4	12	4	0%	34%	15%	22%	20%	23%	0.12	0.12	1.53		
B21	Rectangle-Half S	73%	4	4	12	4	12	4	0%	17%	7%	26%	25%	11%	0.12	0.12	1.53		
B22	Rectangle-Half S	44%	4	4	12	4	12	4	0%	34%	15%	22%	20%	23%	0.12	0.12	1.53		
B23	Rectangle-Half S	15%	4	4	12	4	12	4	0%	52%	23%	17%	15%	34%	0.12	0.12	1.53		
B24	Rectangle-Half S	58%	4	4	12	4	12	4	0%	25%	11%	24%	23%	17%	0.12	0.12	1.53		
B25	Rectangle-Half S	29%	4	4	12	4	12	4	0%	43%	19%	19%	18%	28%	0.12	0.12	1.53		
B26	Rectangle-Half S	44%	4	4	12	4	12	4	0%	34%	15%	22%	20%	23%	0.12	0.12	1.53		
B31	Rectangle-Half S	39%	4	4	12	4	12	4	0%	37%	17%	21%	20%	24%	0.12	0.12	1.53		
B32	Rectangle-Half S	19%	4	4	12	4	12	4	0%	49%	22%	18%	16%	32%	0.12	0.12	1.53		
B33	Rectangle-Half S	39%	4	4	12	4	12	4	0%	37%	17%	21%	20%	24%	0.12	0.12	1.53		
B34	Rectangle-Half S	19%	4	4	12	4	12	4	0%	49%	22%	18%	16%	32%	0.12	0.12	1.53		
B35	Rectangle-Half S	10%	4	4	12	4	12	4	0%	55%	24%	16%	15%	36%	0.12	0.12	1.53		
B36	Rectangle-Half S	32%	4	4	12	4	12	4	0%	42%	18%	20%	18%	27%	0.12	0.12	1.53		
C11	Circle	60%	4	4	12	4	12	4	0%	24%	11%	24%	23%	16%	0.12	0.12	1.53		
C12	Circle	40%	4	4	12	4	12	4	0%	37%	16%	21%	20%	24%	0.12	0.12	1.53		
C13	Circle	20%	4	4	12	4	12	4	0%	49%	22%	18%	16%	32%	0.12	0.12	1.53		
C21	Circle	78%	4	4	12	4	12	4	0%	13%	6%	27%	26%	9%	0.12	0.12	1.53		
C22	Circle	79%	4	4	12	4	12	4	0%	13%	6%	27%	26%	9%	0.12	0.12	1.53		
C23	Circle	42%	4	4	12	4	12	4	0%	35%	16%	21%	20%	23%	0.12	0.12	1.53		
C24	Circle	38%	4	4	12	4	12	4	0%	38%	17%	21%	20%	25%	0.12	0.12	1.53		
C25	Circle	65%	4	4	12	4	12	4	0%	21%	9%	25%	24%	14%	0.12	0.12	1.53		
C31	Circle	70%	4	4	12	4	12	4	0%	18%	8%	26%	25%	12%	0.12	0.12	1.53		
C32	Circle	57%	4	4	12	4	12	4	0%	26%	12%	24%	23%	17%	0.12	0.12	1.53		
C33	Circle	35%	4	4	12	4	12	4	0%	40%	18%	20%	19%	26%	0.12	0.12	1.53		
C34	Circle	63%	4	4	12	4	12	4	0%	23%	10%	24%	24%	15%	0.12	0.12	1.53		
C35	Circle	40%	4	4	12	4	12	4	0%	37%	16%	21%	20%	24%	0.12	0.12	1.53		
C36	Circle	20%	4	4	12	4	12	4	0%	49%	21%	18%	16%	32%	0.12	0.12	1.53		
C41	Circle	52%	4	4	12	4	12	4	0%	29%	13%	23%	22%	19%	0.12	0.12	1.53		
C42	Circle	34%	4	4	12	4	12	4	0%	40%	18%	20%	19%	26%	0.12	0.12	1.53		
C43	Circle	44%	4	4	12	4	12	4	0%	34%	15%	22%	20%	22%	0.12	0.12	1.53		
C51	Circle	54%	4	4	12	4	12	4	0%	28%	12%	23%	22%	18%	0.12	0.12	1.53		
C52	Circle	44%	4	4	12	4	12	4	0%	34%	15%	22%	20%	22%	0.12	0.12	1.53		
C53	Circle	46%	4	4	12	4	12	4	0%	33%	15%	22%	21%	22%	0.12	0.12	1.53		
C54	Circle	49%	4	4	12	4	12	4	0%	31%	14%	22%	21%	20%	0.12	0.12	1.53		
C55	Circle	36%	4	4	12	4	12	4	0%	39%	17%	20%	19%	26%	0.12	0.12	1.53		
C14	Triangle	51%	4	4	12	4	12	4	0%	30%	13%	23%	22%	20%	0.12	0.12	1.53		
C15	Triangle	36%	4	4	12	4	12	4	0%	39%	17%	20%	19%	26%	0.12	0.12	1.53		
C16	Triangle	31%	4	4	12	4	12	4	0%	42%	19%	20%	18%	28%	0.12	0.12	1.53		
C61	Triangle	65%																	

Panel Layers			Layers						UV %	Visible Light Transmittance	Total Solar Transmittance	Visible Reflectance		Solar Heat Gain Coefficient	U-Value (BTU/hrft2F)		Light to Solar Gain
Panel Type	Shape	Cell Coverage Area	Glass L1 Thickness	Glass L2 Thickness	Spacer Size	Glass L3 Thickness	Spacer Size	Glass L4 Thickness				Exterior	Interior		Winter Nighttime	Summer Daytime	
C74	Triangle	47%	4	4	12	4	12	4	0%	32%	14%	22%	21%	21%	0.12	0.12	1.53
C75	Triangle	37%	4	4	12	4	12	4	0%	38%	17%	21%	19%	25%	0.12	0.12	1.53
C76	Triangle	41%	4	4	12	4	12	4	0%	36%	16%	21%	20%	23%	0.12	0.12	1.53
C17	Hexagon	48%	4	4	12	4	12	4	0%	32%	14%	22%	21%	21%	0.12	0.12	1.53
C18	Hexagon	32%	4	4	12	4	12	4	0%	41%	18%	20%	18%	27%	0.12	0.12	1.53
C19	Hexagon	16%	4	4	12	4	12	4	0%	51%	23%	17%	16%	34%	0.12	0.12	1.53
C81	Hexagon	68%	4	4	12	4	12	4	0%	20%	9%	25%	25%	13%	0.12	0.12	1.53
C82	Hexagon	36%	4	4	12	4	12	4	0%	39%	17%	20%	19%	25%	0.12	0.12	1.53
C83	Hexagon	36%	4	4	12	4	12	4	0%	39%	17%	20%	19%	25%	0.12	0.12	1.53
C84	Hexagon	52%	4	4	12	4	12	4	0%	29%	13%	23%	22%	19%	0.12	0.12	1.53
C85	Hexagon	22%	4	4	12	4	12	4	0%	48%	21%	18%	17%	31%	0.12	0.12	1.53
C91	Hexagon	69%	4	4	12	4	12	4	0%	19%	8%	25%	25%	12%	0.12	0.12	1.53
C92	Hexagon	53%	4	4	12	4	12	4	0%	29%	13%	23%	22%	19%	0.12	0.12	1.53
C93	Hexagon	37%	4	4	12	4	12	4	0%	38%	17%	21%	19%	25%	0.12	0.12	1.53
C94	Hexagon	10%	4	4	12	4	12	4	0%	55%	24%	16%	15%	36%	0.12	0.12	1.53
C95	Hexagon	32%	4	4	12	4	12	4	0%	42%	18%	20%	18%	27%	0.12	0.12	1.53
C96	Hexagon	47%	4	4	12	4	12	4	0%	32%	14%	22%	21%	21%	0.12	0.12	1.53
C101	Parallelogram	63%	4	4	12	4	12	4	0%	22%	10%	24%	24%	15%	0.12	0.12	1.53
C102	Parallelogram	30%	4	4	12	4	12	4	0%	43%	19%	19%	18%	28%	0.12	0.12	1.53
C103	Parallelogram	37%	4	4	12	4	12	4	0%	39%	17%	20%	19%	25%	0.12	0.12	1.53
C104	Parallelogram	32%	4	4	12	4	12	4	0%	42%	18%	20%	18%	27%	0.12	0.12	1.53
C105	Parallelogram	23%	4	4	12	4	12	4	0%	47%	21%	18%	17%	31%	0.12	0.12	1.53
C106	Parallelogram	50%	4	4	12	4	12	4	0%	31%	14%	22%	21%	20%	0.12	0.12	1.53
C111	Parallelogram	53%	4	4	12	4	12	4	0%	29%	13%	23%	22%	19%	0.12	0.12	1.53
C112	Parallelogram	40%	4	4	12	4	12	4	0%	37%	16%	21%	20%	24%	0.12	0.12	1.53
C113	Parallelogram	43%	4	4	12	4	12	4	0%	35%	15%	21%	20%	23%	0.12	0.12	1.53
C114	Parallelogram	27%	4	4	12	4	12	4	0%	45%	20%	19%	18%	29%	0.12	0.12	1.53
C115	Parallelogram	40%	4	4	12	4	12	4	0%	37%	16%	21%	20%	24%	0.12	0.12	1.53
C116	Parallelogram	27%	4	4	12	4	12	4	0%	45%	20%	19%	18%	29%	0.12	0.12	1.53

Panel Layers			Layers						UV %	Visible Light Transmittance	Total Solar Transmittance	Visible Reflectance		Solar Heat Gain Coefficient	U-Value (BTU/hrft2F)		Light to Solar Gain
Panel Type	Shape	Cell Coverage Area	Class L1 Thickness	Class L2 Thickness	Spacer Size	Class L3 Thickness	Spacer Size	Class L4 Thickness				Exterior	Interior		Winter Nighttime	Summer Daytime	
C74	Triangle	47%	6	6	12	6	12	6	0%	32%	14%	22%	21%	21%	0.12	0.12	1.54
C75	Triangle	37%	6	6	12	6	12	6	0%	38%	17%	21%	19%	25%	0.12	0.12	1.54
C76	Triangle	41%	6	6	12	6	12	6	0%	35%	16%	21%	20%	23%	0.12	0.12	1.54
C17	Hexagon	48%	6	6	12	6	12	6	0%	31%	14%	22%	21%	20%	0.12	0.12	1.54
C18	Hexagon	32%	6	6	12	6	12	6	0%	41%	18%	20%	18%	26%	0.12	0.12	1.54
C19	Hexagon	16%	6	6	12	6	12	6	0%	50%	23%	17%	16%	33%	0.12	0.12	1.54
C81	Hexagon	68%	6	6	12	6	12	6	0%	19%	9%	25%	25%	12%	0.12	0.12	1.54
C82	Hexagon	36%	6	6	12	6	12	6	0%	38%	17%	20%	19%	25%	0.12	0.12	1.54
C83	Hexagon	36%	6	6	12	6	12	6	0%	38%	17%	20%	19%	25%	0.12	0.12	1.54
C84	Hexagon	52%	6	6	12	6	12	6	0%	29%	13%	23%	22%	19%	0.12	0.12	1.54
C85	Hexagon	22%	6	6	12	6	12	6	0%	47%	21%	18%	17%	31%	0.12	0.12	1.54
C91	Hexagon	69%	6	6	12	6	12	6	0%	19%	8%	25%	25%	12%	0.12	0.12	1.54
C92	Hexagon	53%	6	6	12	6	12	6	0%	28%	13%	23%	22%	18%	0.12	0.12	1.54
C93	Hexagon	37%	6	6	12	6	12	6	0%	38%	17%	21%	19%	24%	0.12	0.12	1.54
C94	Hexagon	10%	6	6	12	6	12	6	0%	54%	24%	16%	15%	35%	0.12	0.12	1.54
C95	Hexagon	32%	6	6	12	6	12	6	0%	41%	18%	20%	18%	27%	0.12	0.12	1.54
C96	Hexagon	47%	6	6	12	6	12	6	0%	32%	14%	22%	21%	21%	0.12	0.12	1.54
C101	Parallelogram	63%	6	6	12	6	12	6	0%	22%	10%	24%	24%	14%	0.12	0.12	1.54
C102	Parallelogram	30%	6	6	12	6	12	6	0%	42%	19%	19%	18%	27%	0.12	0.12	1.54
C103	Parallelogram	37%	6	6	12	6	12	6	0%	38%	17%	20%	19%	25%	0.12	0.12	1.54
C104	Parallelogram	32%	6	6	12	6	12	6	0%	41%	18%	20%	18%	27%	0.12	0.12	1.54
C105	Parallelogram	23%	6	6	12	6	12	6	0%	46%	21%	18%	17%	30%	0.12	0.12	1.54
C106	Parallelogram	50%	6	6	12	6	12	6	0%	30%	14%	22%	21%	20%	0.12	0.12	1.54
C111	Parallelogram	53%	6	6	12	6	12	6	0%	28%	13%	23%	22%	18%	0.12	0.12	1.54
C112	Parallelogram	40%	6	6	12	6	12	6	0%	36%	16%	21%	20%	23%	0.12	0.12	1.54
C113	Parallelogram	43%	6	6	12	6	12	6	0%	34%	15%	21%	20%	22%	0.12	0.12	1.54
C114	Parallelogram	27%	6	6	12	6	12	6	0%	44%	20%	19%	18%	29%	0.12	0.12	1.54
C115	Parallelogram	40%	6	6	12	6	12	6	0%	36%	16%	21%	20%	23%	0.12	0.12	1.54
C116	Parallelogram	27%	6	6	12	6	12	6	0%	44%	20%	19%	18%	29%	0.12	0.12	1.54



LEARN MORE:

MITREX.COM

 info@mitrex.com

 +1-855-254-0214 (Toll Free)

Headquarters:

 41 Racine Rd., Toronto,
ON M9W 2Z4, Canada

 +1 (416) 497 7120

USA:

 10880 Wilshire Blvd Suite 1101,
Los Angeles, CA 90024, USA

 +1 (323) 301 7978

 1 Rockefeller Plaza Fl 11,
New York, NY 10020, USA

 +1 (646) 583 4486