



MITREX SOLAR FACADE

Installation Manual





⚡ Mitrex Solar Facade

INDEX

Safety Precautions & Handling of Modules	P. 4
Manual Disclaimer	P. 4
Limitation of Liability	P. 6
Product Certifications	P. 6
Mitrex Solar Facade	P. 8
Solar Facade Details	P. 9
Material Needed	P. 10
Tools Needed	P. 11
Fastener Information for Portrait Installation	P. 12
Fastener Information for Landscape Installation	P. 13
Before You Start	P. 14
Product Installation	P. 16
Electrical Installation	P. 26
General Wiring Requirements	P. 28
PV Connection	P. 28
Series Connection	P. 28
Parallel Connection	P. 28
Electrical Grounding	P. 29
Site Considerations	P. 29
Module Mounting	P. 30
Limited Warranty	P. 32
Frequently Asked Questions	P. 34
Appendix	P. 36

SAFETY PRECAUTIONS & HANDLING OF MODULES

The following instructions relate to the safety and intended use of PV modules. Failure to comply with any instructions below may result in PRODUCT DAMAGE, PHYSICAL INJURY AND/OR DEATH.

MANUAL DISCLAIMER

The information presented in this manual is subject to change by Mitrex without prior notice. Mitrex gives no warranty of any kind whatsoever, either explicitly or implicitly, with respect to the information herein. In the case of any inconsistency between different language versions, the English version shall overcome and take control in all respects.

- ⬡ **All electrical connections must be handled by licensed electricians** in accordance with the applicable geographic electrical codes and standards.
- ⬡ Always use appropriate Personal Protective Equipment when installing PV modules.
- ⬡ Always use electrically insulated tools to reduce the risk of electric shock.
- ⬡ The PV module does not contain any serviceable parts.
- ⬡ Do not attempt to modify or repair any part of the module.
- ⬡ Perform all work in safe and dry conditions.
- ⬡ External or artificially concentrated sunlight shall not be directed onto the PV module.
- ⬡ Do not use or install damaged modules.
- ⬡ Do not connect or disconnect modules when current from the modules or an external source is present.

- ⬡ Modules should be stored in a dry and ventilated environment to avoid direct sunlight and moisture.

⚠ If modules are stored in an uncontrolled environment, the storage time should be less than 3 months and extra precautions should be taken to prevent connectors from being exposed to moisture or sunlight, like using connector endcaps.

- ⬡ Modules must always be handled and installed by two people.
- ⬡ Handle the module in a way that avoids breakage, scratching, bending of the glass and backsheet.
- ⬡ Do not carry the module by its cables.
- ⬡ Do not stand, step, walk and / or jump on modules under any circumstances.
- ⬡ Do not drop or place objects (such as tools) on the modules.

- ⬡ Do not use sharp instruments on the modules.
- ⬡ Particular care should be taken to avoid module backsheets being damaged by sharp objects, as scratches may directly affect product safety.
- ⬡ Do not lift modules by their wires or junction box.
- ⬡ Do not place excessive loads on the module.
- ⬡ Do not leave modules unsupported or unsecured.
- ⬡ Keep all connectors clean and dry at all times.
- ⬡ Do not expose the modules and its connectors to any unauthorized chemical substance (e.g. oil, lubricant, pesticide, etc.).

LIMITATION OF LIABILITY

Mitrex shall not be held responsible for damages of any kind, including – without limitation – bodily harm, injury or damage to property, in connection with handling PV modules, system installation, or compliance or non-compliance with the instructions set forth in this manual.

PRODUCT CERTIFICATIONS

Mitrex products meet and/or exceed the requirements set forth by UL 61730, UL 61215, CSA C22.2 NO. 61730, CSA C22.2 NO. 61215, IEC 61730 and IEC 61215 for PV modules.

These UL, CSA and IEC to be freestanding. To satisfy the listing for this product the modules must be mounted with a rack or standoff structure. The module is considered to be in compliance with UL 61215/61730, CSA 61215/61730 and/or IEC 61215/61730 only when the module is mounted in the manner specified by the mounting instructions contained in this document.

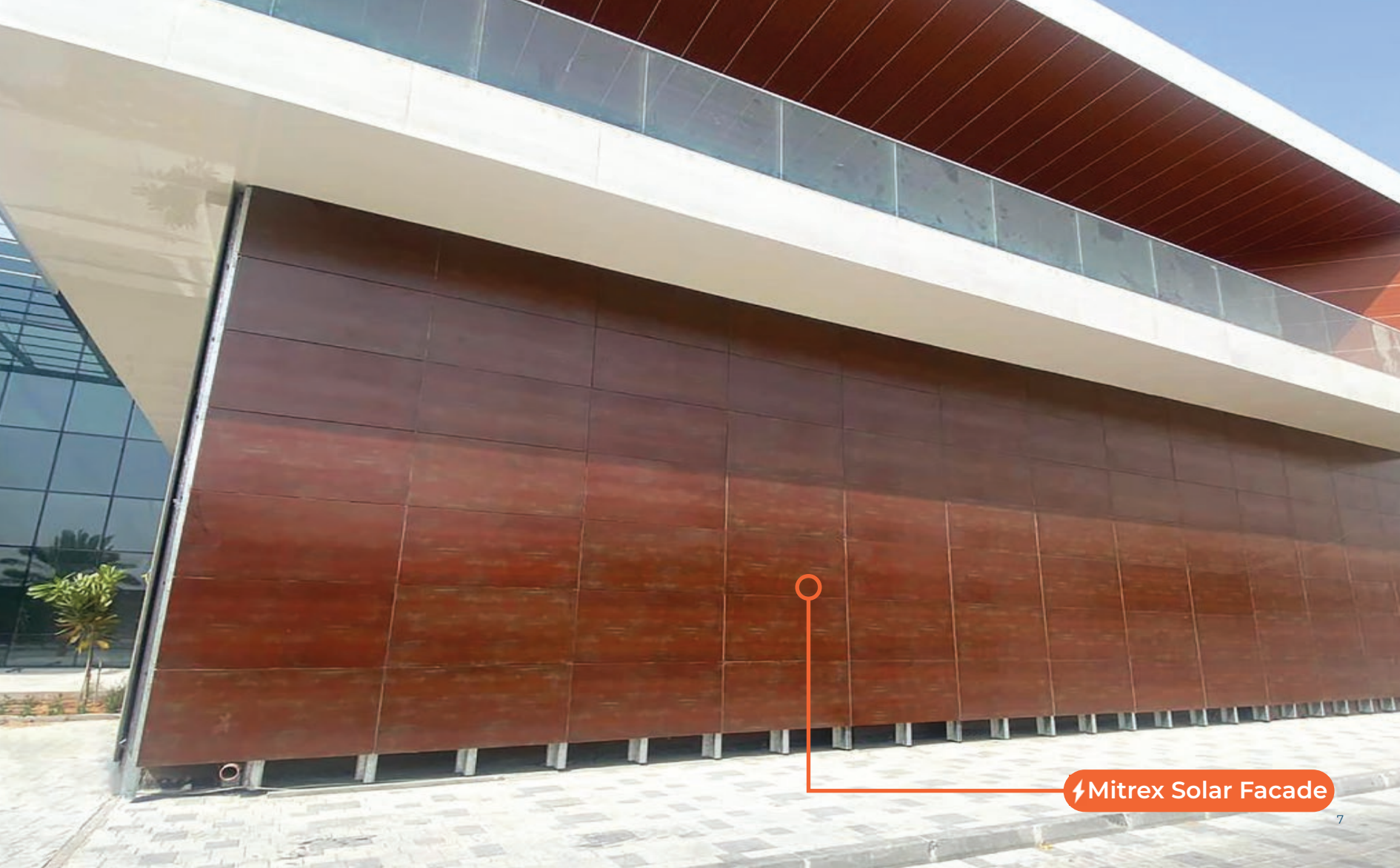

⚡ Mitrex Solar Facade

MITREX SOLAR FACADE

SOLAR FACADE DETAILS

Each Mitrex Solar Facade panel comes with the junction box, and connectors.

FRONT VIEW

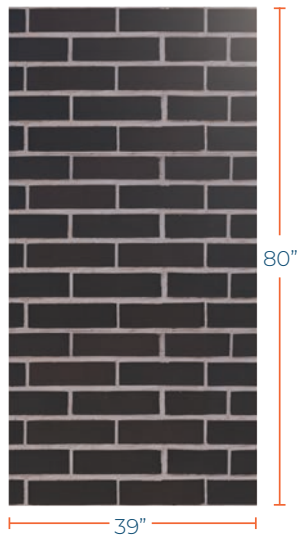

BACK VIEW

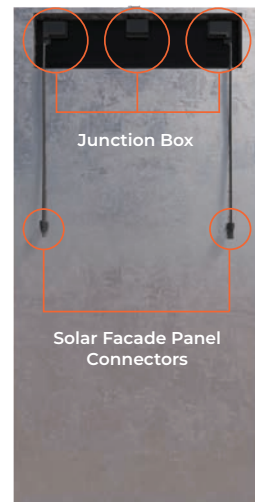

SECTION VIEW



MATERIAL NEEDED

The following tools are required to install Mitrex Solar Facade.

INTERLOCKING (IL) CHANNEL

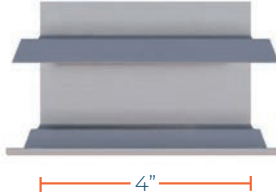

SCREWS



RIVETS



TYPE OF WALL + INTERLOCKING CHANNEL

Brick Wall

Concrete Wall

Wood Wall

Steel Stud Wall

1" Honeycomb Backing

SCREWS

TYPE OF SCREW

410 Stainless steel tapcon

1/4" x 3 1/4" Tapcon Hex Carbon Steel Blue

3 1/2" Stainless Steel Deck Screw With Washer

10x3/4" Self drill Hex Head

Butterfly Rivet 3/4"

TOOLS NEEDED

The following tools are required to install Mitrex Solar Facade.

DRILL



IMPACT



RIVET GUN



HEX SOCKET



DRILL BIT



MEASURING TAPE



LEVEL



T-SQUARE RULER



CLOTH



PROTECTIVE FOAM



FASTENER INFORMATION FOR VERTICAL INSTALLATION

INTERLOCKING (IL) CHANNELS DISTANCE



PANEL IL DRILLING DISTANCE

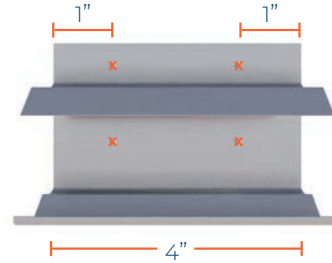

WALL IL DRILLING DISTANCE

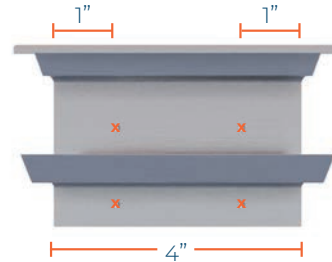

For 1 Panel
Installation

RIVETS

OF IL

PANEL

32

8

For 1 Panel
Installation

SCREWS

OF IL

WALL

32

8

FASTENER INFORMATION FOR HORIZONTAL INSTALLATION

INTERLOCKING (IL) CHANNELS DISTANCE

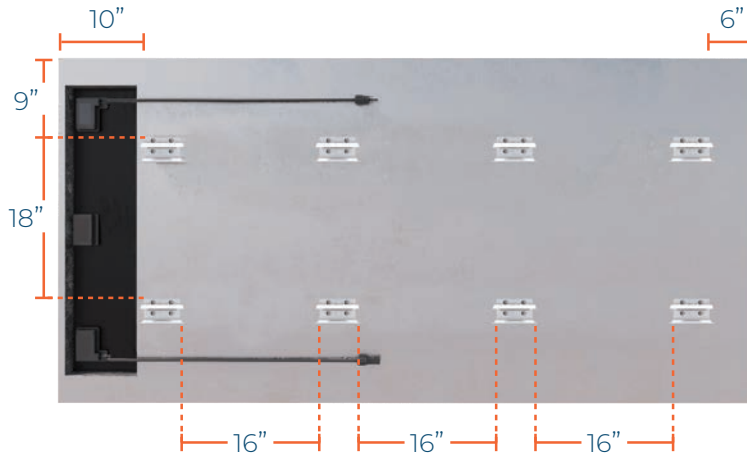

PANEL IL DRILLING DISTANCE

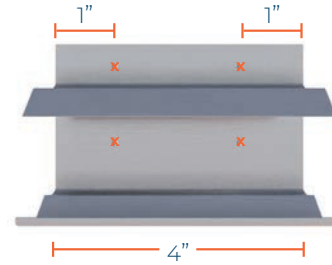

WALL IL DRILLING DISTANCE

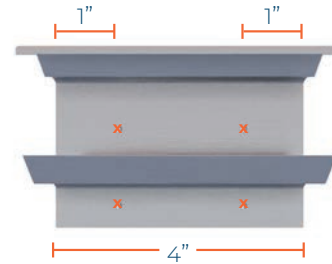

For 1 Panel
Installation

RIVETS

OF IL

PANEL

32

8

For 1 Panel
Installation

SCREWS

OF IL

WALL

32

8

BEFORE YOU START

- 1 Map out where your panels are going on the exterior wall. Ensure the panels fit on the space.
- 2 Ensure the wall area selected is clean and clear of any obstructions.



- 3 Determine the orientation of your panels. Vertical and horizontal orientation of panels will affect the installation.





⚡ Mitrex Solar Facade

PRODUCT INSTALLATION



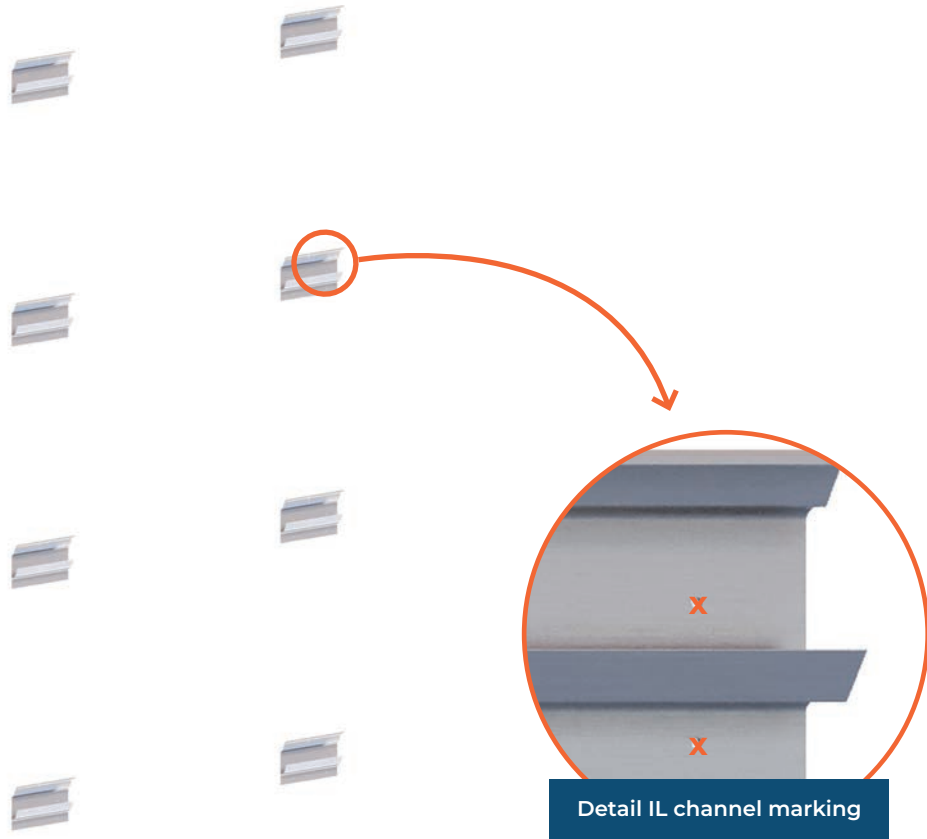

VERTICAL INSTALLATION

Prepare the interlocking channels for the wall.

- 1** **x8**
Interlocking (IL) Channel
- x1**
Measuring Tape
- x1**
T-Square Ruler

Mark the interlocking channel with the place the screw will be drilled. Ensure you follow the correct measurement. Check page: 12

! For horizontal panel installation, follow the same steps, utilizing the measurements for the horizontal panels (found on page 13).

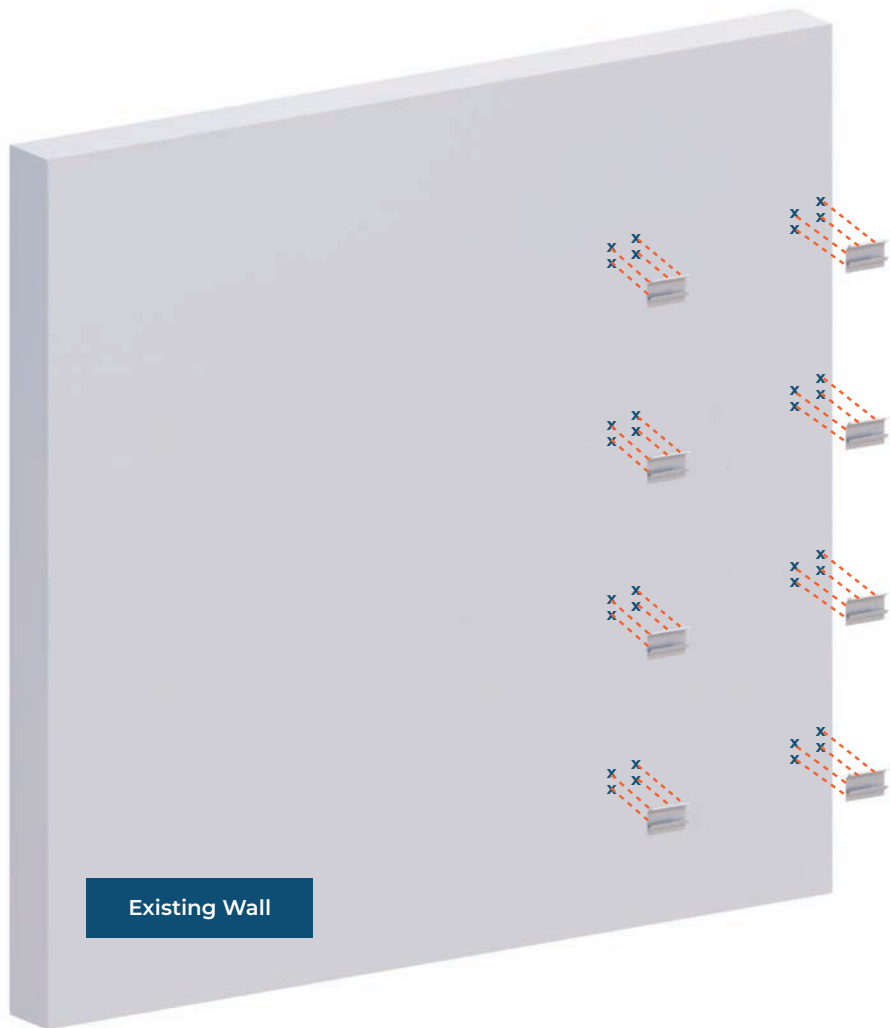

VERTICAL INSTALLATION

Prepare the interlocking channels for the wall.

2

x1



Measuring
Tape

x1



T-Square
Ruler

Measure where your channels will go on the wall, ensure you have the correct spacing. Check page 12.



For horizontal panel installation, follow the same steps, utilizing the measurements for the horizontal panels (found on page 13).

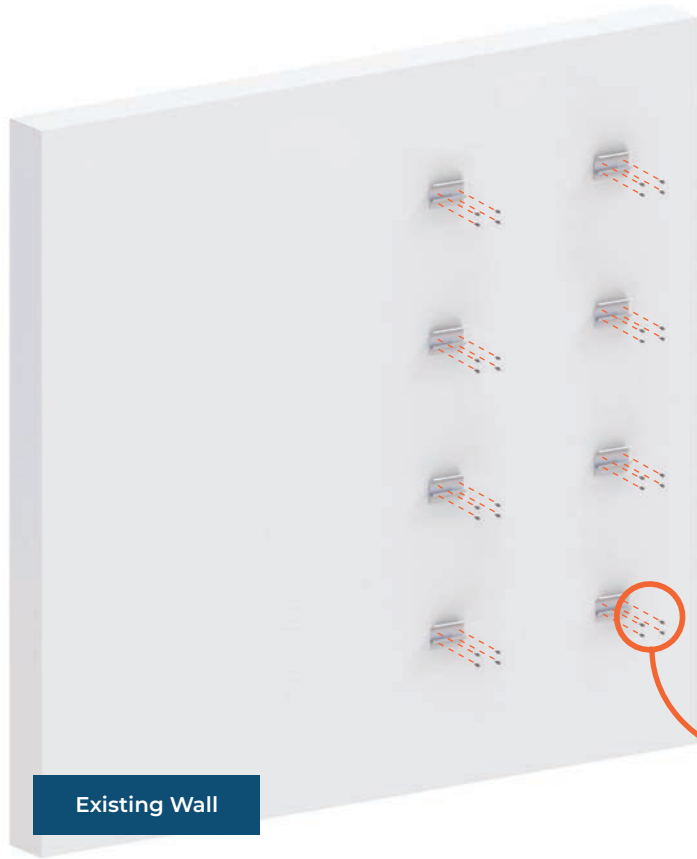

Existing Wall

Detail of screw and IL channel on wall.

VERTICAL INSTALLATION

Prepare the interlocking channels for the wall.

3

x32



Self-drill Screw

x1



Impact Tool

x1



Hex Socket

Screw the interlocking channels into the wall.



For horizontal panel installation, follow the same steps, utilizing the measurements for the horizontal panels (found on page 13).

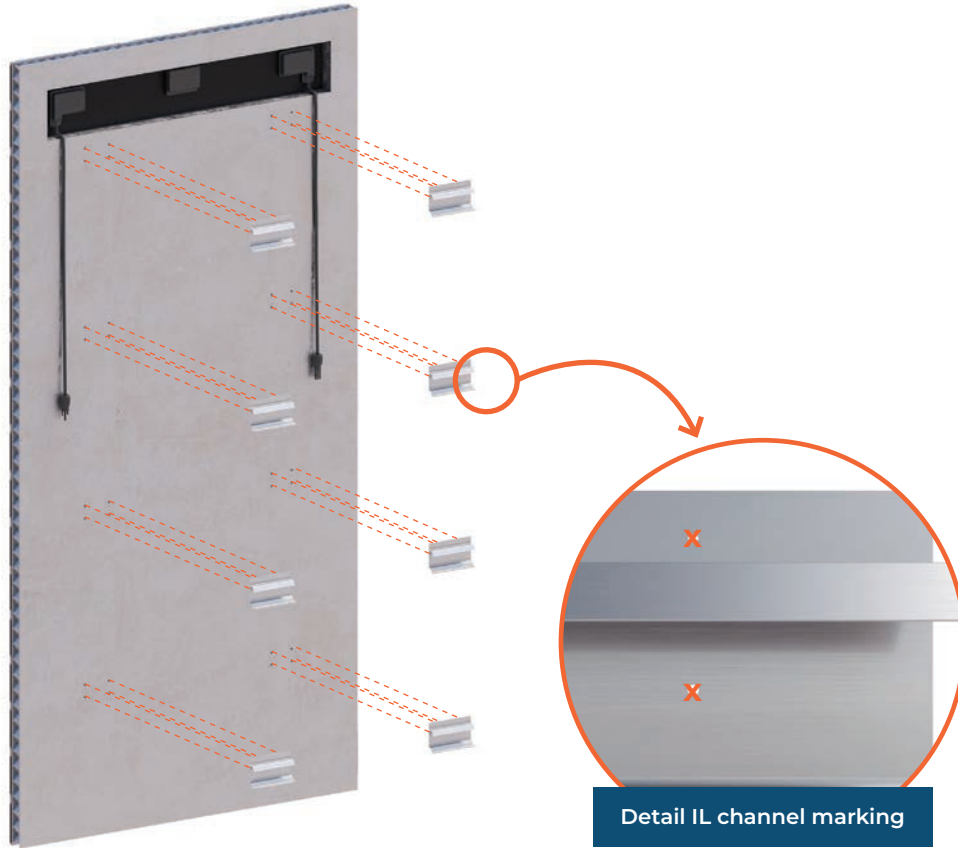

VERTICAL INSTALLATION

Prepare the interlocking channels for the panels.

4

x8



Interlocking (IL)
Channel

x1



Measuring
Tape

x1



T-Square
Ruler

x1



Protective Foam

Mark the interlocking channels and honeycomb with the place where the screw will be drilled. Ensure you follow the correct measurement. Check page 12.

Make sure that you lay the panel on a protective foam to ensure it does not get damaged.



For horizontal panel installation, follow the same steps, utilizing the measurements for the horizontal panels (found on page 13).

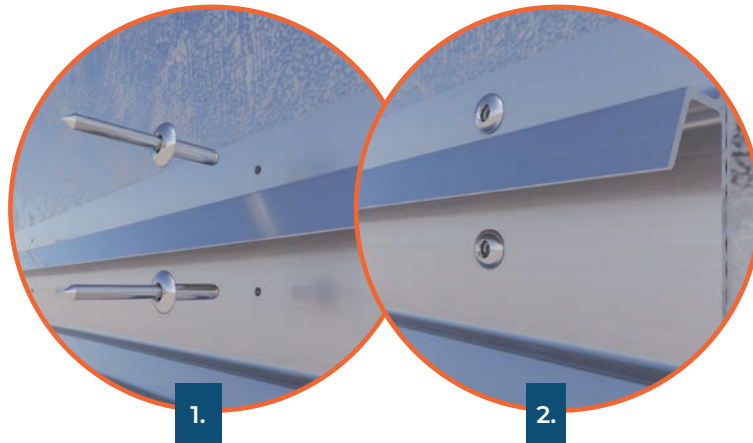
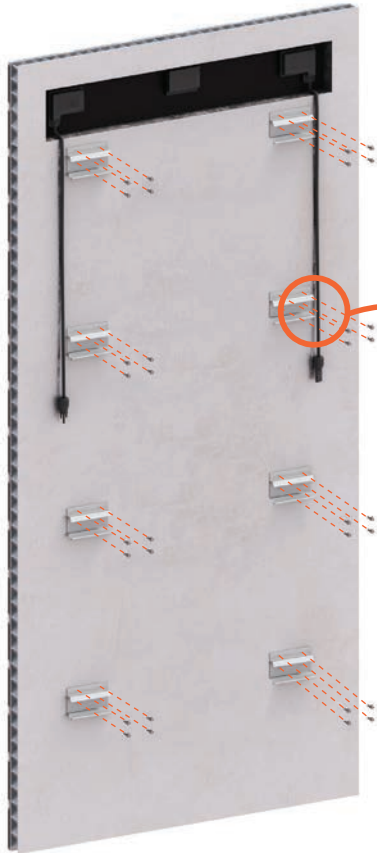

VERTICAL INSTALLATION

Prepare the interlocking channels for the panels.

5

x32

x1



Rivet



Rivet Gun

Fasten the interlocking channels into the panel with the rivets.



For horizontal panel installation, follow the same steps, utilizing the measurements for the horizontal panels (found on page 13).

VERTICAL INSTALLATION

Mounting of panel.

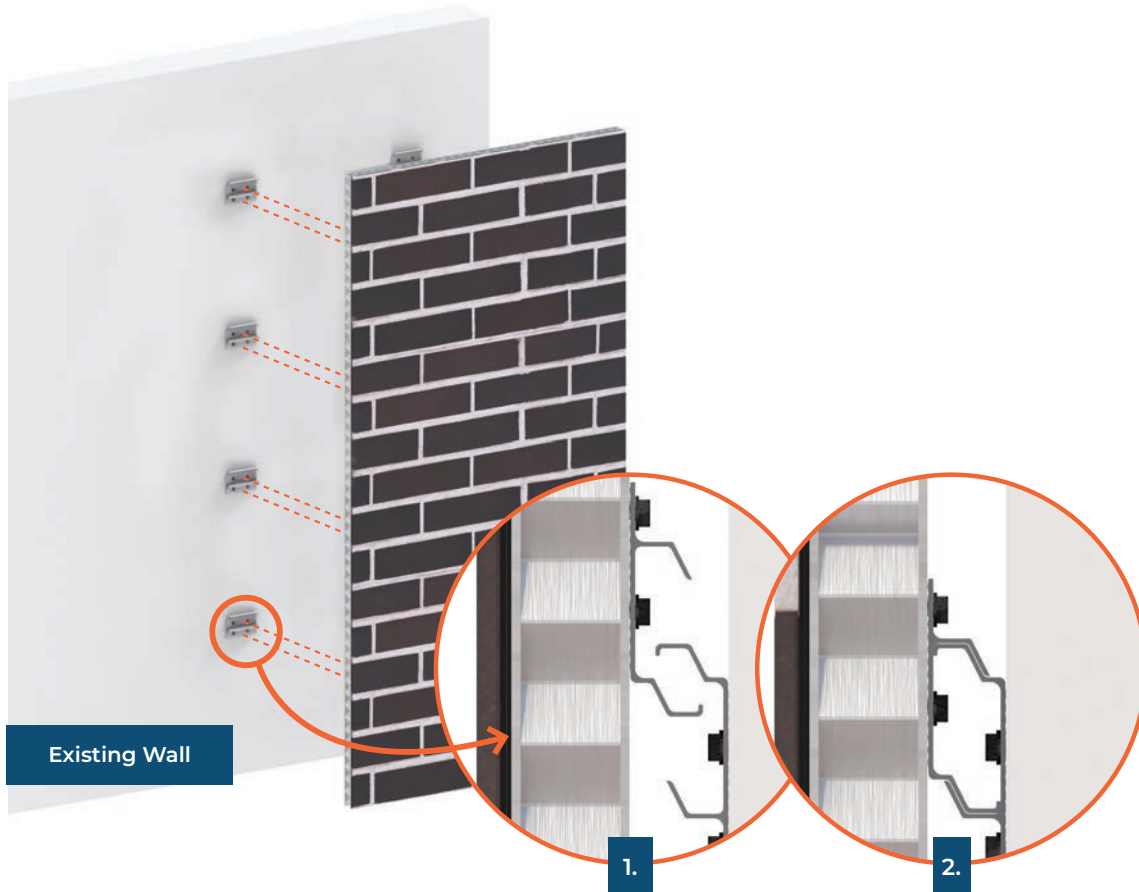

6

x1



Cloth

Mount the panel onto the wall by hooking in the panel channels onto the wall channels. Ensure the panels are cleaned of dirt and dust.

⚠ Ensure each solar module is grounded. Work with a certified electrician.

⚠ For horizontal panel installation, follow the same steps, utilizing the measurements for the horizontal panels (found on page 13).

VERTICAL INSTALLATION

Mounting of panel.

- 7 Repeat steps 1-6 for all remaining panels.

⚠ For horizontal panel installation, follow the same steps, utilizing the measurements for the horizontal panels (found on page 13).

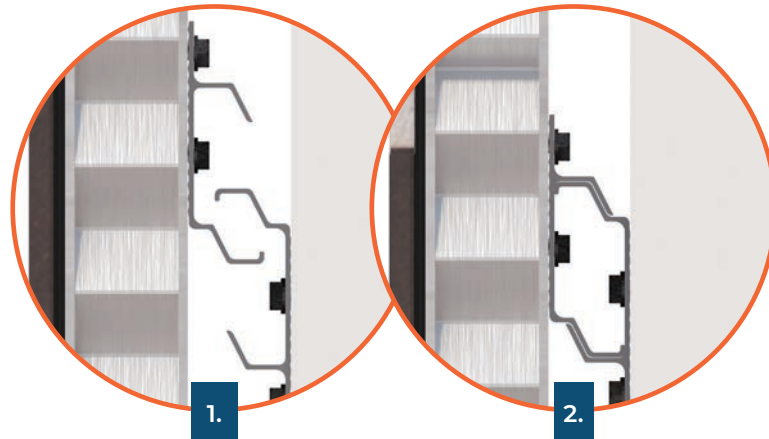
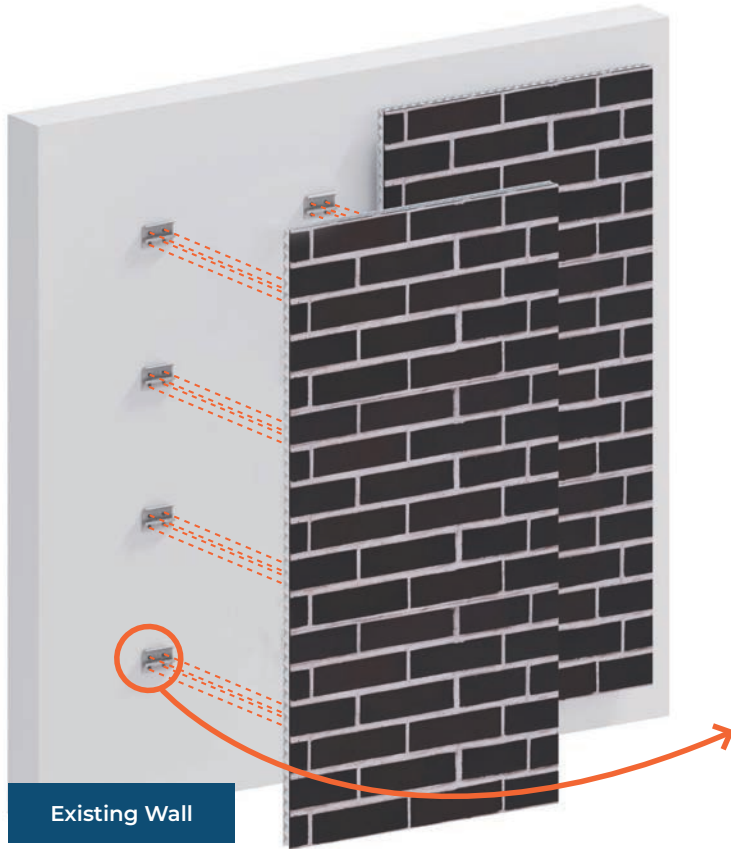

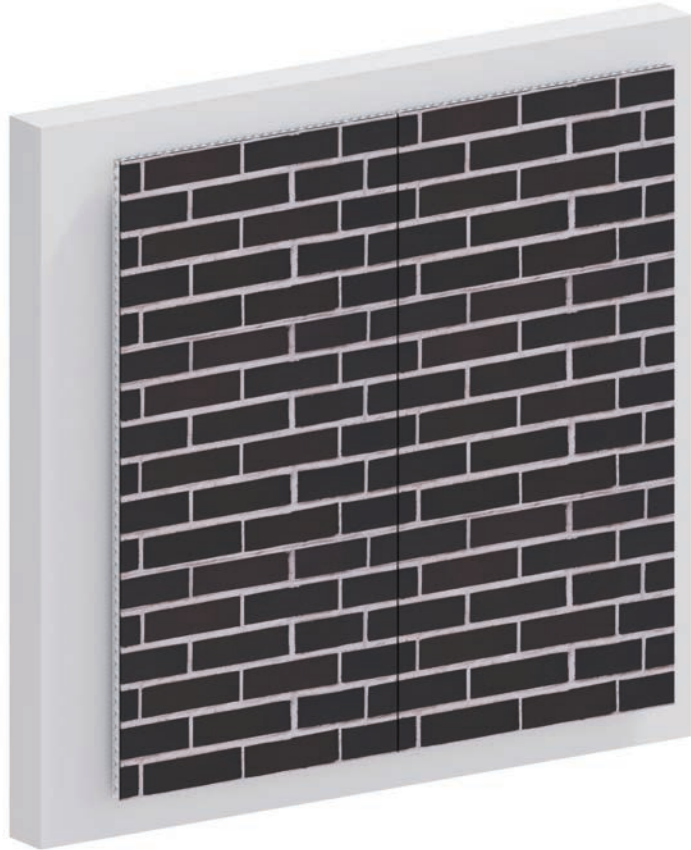

VERTICAL INSTALLATION

Power Connection

8

Make sure to connect the wires in a sequence and based on a string layout with a certified installer.

VERTICAL INSTALLATION

Power Connection

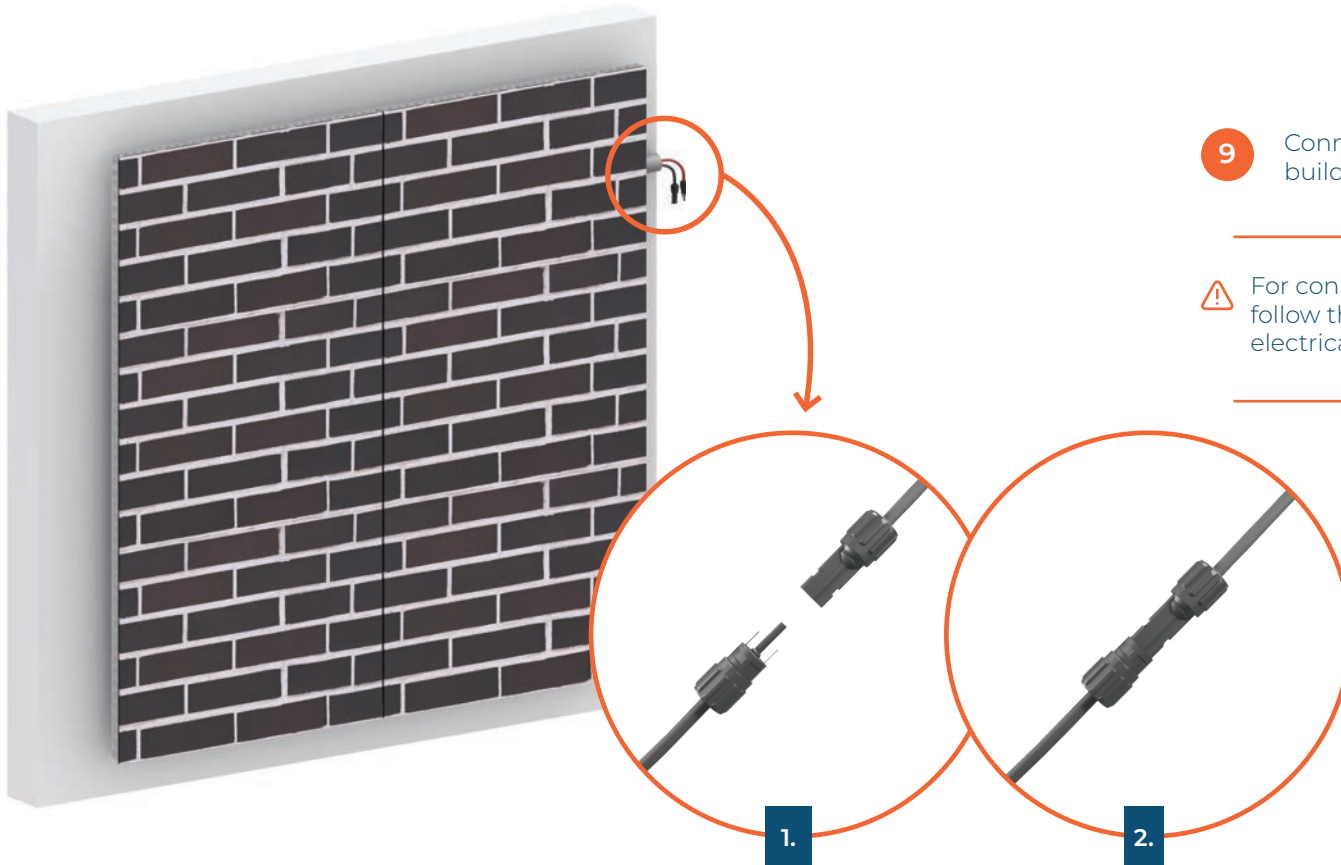

- 9 Connect the panel wiring to the building.

 For connection instructions, please follow the recommendations on electrical installation (Page 26 - 30).

ELECTRICAL INSTALLATION

⚠ Ensure correct polarity when connecting PV modules.

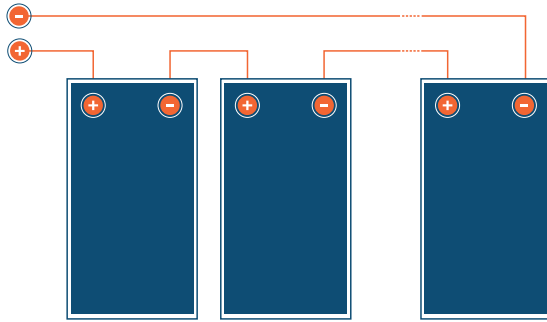

⚠ Make sure that all connections are safe and properly mated. An audible click should be heard when mating connectors. The PV connector should not be subjected to stress from the exterior. Connectors should only be used to connect the circuit. They should never be used to turn the circuit on and off.

⚠ Connectors are not waterproof when unmated. When installing modules, connector should be connected to each other as soon as possible or appropriate measures should be taken to avoid moisture and dust penetrating into the connector.

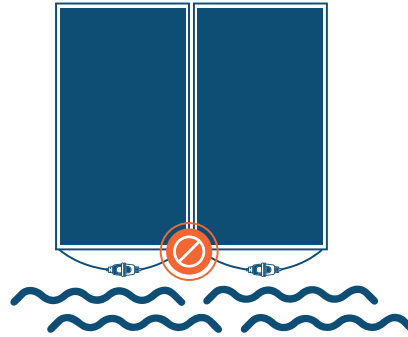

⚠ Ensure that plug connections are secured away from any water-accumulating surfaces. Use UV-resistant cable ties to secure cables to the mounting system. Cables should avoid exposure to direct sunlight.

⚠ Only use dedicated solar cable and suitable connectors (wiring should be sheathed in a sunlight-resistant conduit or, if exposed, should be sunlight-resistant itself) that meet local fire, building and electrical regulations. Please ensure that all wiring is in perfect electrical and mechanical condition.



⚠ Ensure cabling is adequately protected from direct sunlight, dirt, debris, moisture, and mechanical friction.

GENERAL WIRING REQUIREMENTS

- Mitrex recommends that all wiring be double insulated with a minimum rating of 90°C (194°F).
- All wiring should use a flexible copper conductor.
- Minimum size should be determined by applicable codes.
- Mitrex recommends a minimum size of 10AWG.

PV CONNECTION

- All Mitrex solar modules are connected via MC4 connectors.

SERIES CONNECTION

- The solar modules may be wired in series

to produce the desired voltage output.

- The current of each module connected in series should be the same.
- **The maximum PV system voltage for that circuit shall be calculated as the sum of the rated open-circuit voltage** of the series-connected PV modules corrected for the lowest expected ambient temperature.

PARALLEL CONNECTION

- The solar modules may be combined in parallel to produce the desired current output.
- When modules are combined in parallel, the total current is equal to the sum of currents from each module.
- The voltage of each module connected in parallel should be the same.
- When connecting plural strings of modules in parallel every series string

or solar module must be fused prior to combining with other strings.

- Abide with all applicable federal, state, and local codes for additional fusing requirements and limitations on the maximum number of solar modules in parallel.
- Depending on national directives, additional safety factors might be applicable for over current protection.

A multiplying factor is required for increased output of the PV modules. Under normal conditions, a PV module is likely to experience conditions that produce more current and/or voltage than reported at standard test conditions.

The requirements of the National Electrical Code (NEC) in Article 690 shall be followed to address these

increased outputs. In installations not under the requirements of the NEC, the values of I_{sc} and V_{oc} marked on this PV module should be multiplied by a factor of 125% when determining component voltage ratings, conductor ampacities, fuse sizes, and size of controls to the PV output.

ELECTRICAL GROUNDING

- ⬡ **All work must be conducted in conformance with all** Federal, State, and local codes and **standards.**
- ⬡ **Grounding connections should be performed by a qualified electrician** for the safety and maintenance of the system in accordance with all national, state and local electrical codes and regulations and standards.
- ⬡ **All bolts, nuts, flat washers, lock washers and other relevant hardware should be made of stainless steel,** unless otherwise specified.

⚠ Where common grounding hardware (nut, bolts, washers) is used to attach a listed grounding device, the attachment must be made in conformance with the grounding device manufacturer's instructions.

⬡ **Connect the honeycomb of the modules together using adequate grounding cables:** Mitrex recommends using 14 mm² (AWG 6) copper wire.

⬡ A module with exposed conductive parts is considered to be in compliance with UL only when is electrically grounded in accordance with the instructions presented below and the requirements of the National Electrical Code.

⚠ Any parts of the aluminum honeycomb at the back of the module can be used as a grounding point of connection.

SITE CONSIDERATIONS

Mitrex Solar Modules should be mounted in a location that meets the following requirements.

- ⬡ The module is intended for use in general open-air climates, as defined in IEC 60721-2-1 Classification of environmental conditions Part-2-1: Environmental conditions appearing in nature - Temperature and humidity.
- ⬡ Please consult the Mitrex technical support department for more information on the use of modules in special climates, such as an altitude greater than 2000m.
- ⬡ Do not operate solar modules near highly flammable substances.
- ⬡ Modules should be installed as to minimize shading.
- ⬡ Note the operating temperature listed in page 37.
- ⬡ Exposing modules to salt (i.e. marine environments) or sulfur (i.e. sulfur sources,

volcanoes) incurs the risk of module corrosion. Special considerations should be made for installations with increased salt content in the air.

- ⬡ Do not expose modules and their connectors to any unauthorized chemical substances (e.g. oil, lubricant, pesticide, etc.), as modules may incur damages.
- ⬡ Do not install modules in an enclosed space.
- ⬡ Failure to comply with these instructions will void Mitrex limited warranty.

only when mounted as specified in the mechanical mounting instructions.

- ⬡ The PV module is considered to be in compliance with UL61730 only when the module is mounted in the manner specified by the mounting instructions.

MODULE MOUNTING

- ⬡ **The mounting design must be certified by a registered professional engineer.**
The mounting design and procedures must comply with all applicable local codes and requirements from all relevant authorities.
- ⬡ PV modules should be oriented to maximize sunlight exposure.
- ⬡ The fire rating of this module is valid

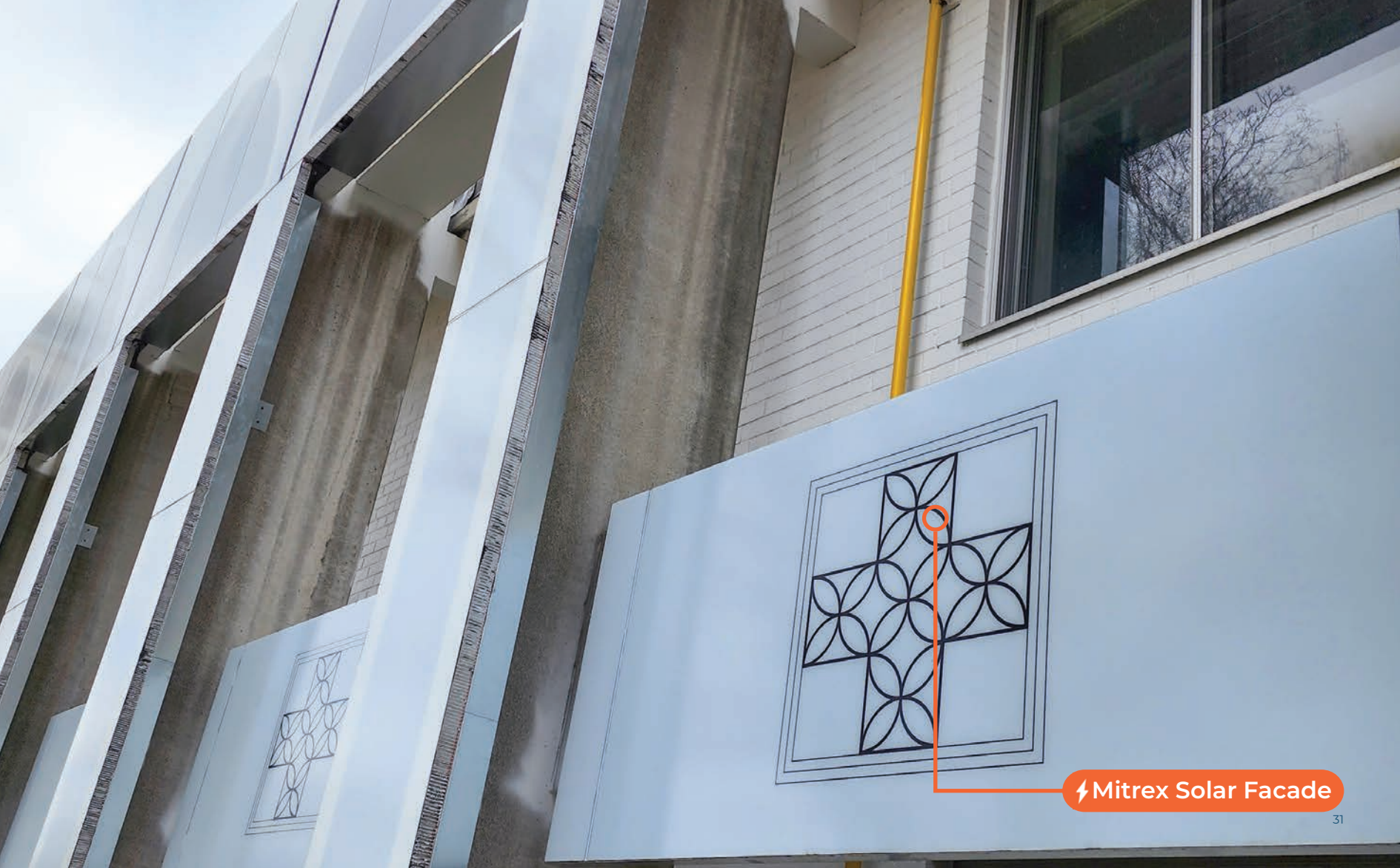

⚡ Mitrex Solar Facade

WARRANTY

Mitrex provides a 25-year hardware warranty, and we guarantee that after 25 years, the efficiency of the panel will be no less than 80% of the original energy generation. For more information on the details covered within the warranty and the claim process, scan the QR code below.

If you have any questions or are experiencing issues with your Solar Facade. Please reach out us at:

 **+1 (416) 497 7120**

 **warranty@mitrex.com**

Or visit our website for more information.



FREQUENTLY ASKED QUESTIONS

Can I install Mitrex Solar Facade panels myself?

For all the electrical connections, you require a licensed electrician. The mechanical connections can be installed by any mechanical installer.

How much energy do my Solar Facade panels produce?

The amount of energy produced by Mitrex Solar Facade panels is dependent on the system size and environmental factors such as shading, dust and debris, snow, and other weather factors. Refer to the Mitrex website to learn more about factors that affect performance.

Will the efficiency of my solar panels go down?

Typically, all solar panels lose efficiency throughout their working life. Mitrex guarantees that after 25 years, the power output will be no less than 80% of the labelled power output.

Do Mitrex solar panels produce energy on a cloudy day?

On cloudy days, Mitrex Solar Facade panels will still generate electricity as there is

diffuse sunlight that allows the panels to produce power. However, the power output will be less than the generation on a sunny day.

If there is a utility power outage, will my solar panels still produce energy?

Yes, if the panels generate energy, they can operate independently from the grid. In the event of a power outage, you can even dedicate the energy to specific equipment in your home.

Are Mitrex Solar Facade panels replaceable if damaged?

Yes, if any of the panels are damaged, they can be easily replaced by any certified installer.

Do I need an energy storage system with my Mitrex Solar Facade?

No, Mitrex Solar Facade panels do not require energy storage systems to function—they can produce energy and supply it directly to your home as needed.

What if I suspect my panel are damaged/do not produce energy?

Look at Your System: When it is safe to do

so, inspect your solar system. Look to see if you can visually identify any sign of damage to the panels. If possible, take photos and videos so the damage can be assessed. We also recommend checking the entire solar system (breakers, inverter, etc) to see if they have been damaged.

Get in Touch: If you can clearly identify that your solar panels have been damaged, you or your installer can get in touch with Mitrex to see how we can help.

Can I return my panels?

Returns of undamaged or unused products will be accepted within 60 days after delivery. There will be a 15% restocking fee applied to all returned products. Clients are responsible for return shipping costs.

APPENDIX

TECHNICAL SPECIFICATIONS

List of mechanical and electrical technical specifications. Electrical test data as per standard test conditions (IEC 60904-3).

	SOLAR FACADE
Length (mm)	2030 (79.9")
Width (mm)	990 (38.9")
Thickness (mm)	38 (1.5")*
Weight (kg)	29 kg
Max System Voltage (V_{SYS})	1000 V
Voltage At Short-Circuit (V_{OC})*	48.3 V - 48.8 V
Current At Short-Circuit (I_{SC})*	6.66 A - 8.32 A
Max Power (P_{MAX})*	250 W - 320 W
Voltage At Max Power (V_{MAX})*	42.7 V - 41.9 V

Current At Max Power (I_{MAX})*

Max Overcurrent Protection Rating

Operating Temperature ($^{\circ}C$)

Junction Box Protection Class

Connector Protection Class

Application

SOLAR FACADE
5.85 A - 7.64 A
20 A
-40 To 85
\geq IP67
IP68
Class A

Under normal conditions, a photovoltaic module is likely to experience conditions that produce higher current and/or voltage than reported at standard test conditions. Accordingly, the values of I_{SC} and V_{OC} marked on this PV module should be multiplied by a factor of 1.25 when determining component voltage ratings, conductor current ratings, and size of controls (e.g. inverter) connected to the PV output.

Temperature correction coefficients for V_{oc} , I_{sc} , P_{max}

TEMPERATURE COEFFICIENT	ALL ABOVE MODULES
αV_{oc}	-0.30 %/ $^{\circ}C$
αI_{sc}	-0.046 %/ $^{\circ}C$
αP_{max}	-0.36 %/ $^{\circ}C$

* Range depending on the pattern of the panel.

A more accurate correction factor can be calculated using the equation below:

$$C = 1 - \alpha \times (25 - T)$$

C: Correction factor

T ($^{\circ}C$): Ambient temperature

α (%/ $^{\circ}C$): Temperature coefficient of the selected module

Electrical sizing and design must be performed by a competent engineer.

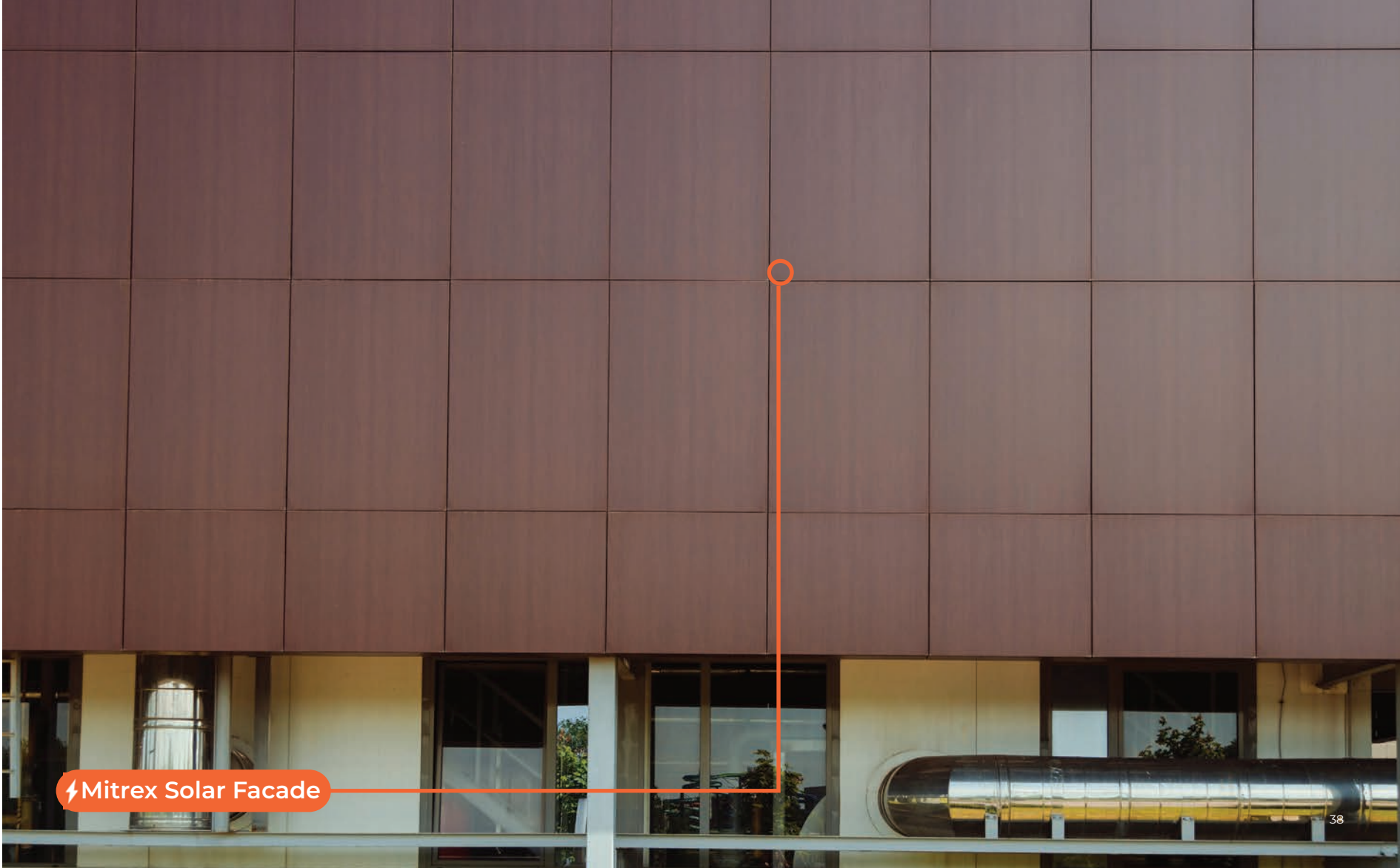



⚡ Mitrex Solar Facade

Learn More:

 mitrex.com

 info@mitrex.com

 41 Racine Rd., Toronto,
ON M9W 2Z4, Canada

 +1 (416) 497 7120

 10880 Wilshire Blvd Suite 1101,
Los Angeles, CA 90024, USA

 +1 (323) 301 7978

 1 Rockefeller Plaza Fl 11,
New York, NY 10020, USA

 +1 (646) 583 4486

