



---

# DESIGNING WITH SUSTAINABLE FACADES

MODULE ACCENTS

# DESIGNING WITH SUSTAINABLE FACADES

In the realm of sustainable architecture, every detail counts, and one often-overlooked yet crucial aspect is panel edge closure options. These options will help to enhance the visual appeal of the building design. In this document, we will embark on a journey through the Mitrex and Cladify panel edge closure solutions, offering you insights, strategies, and innovative approaches to integrate sustainable practices into your facade designs.

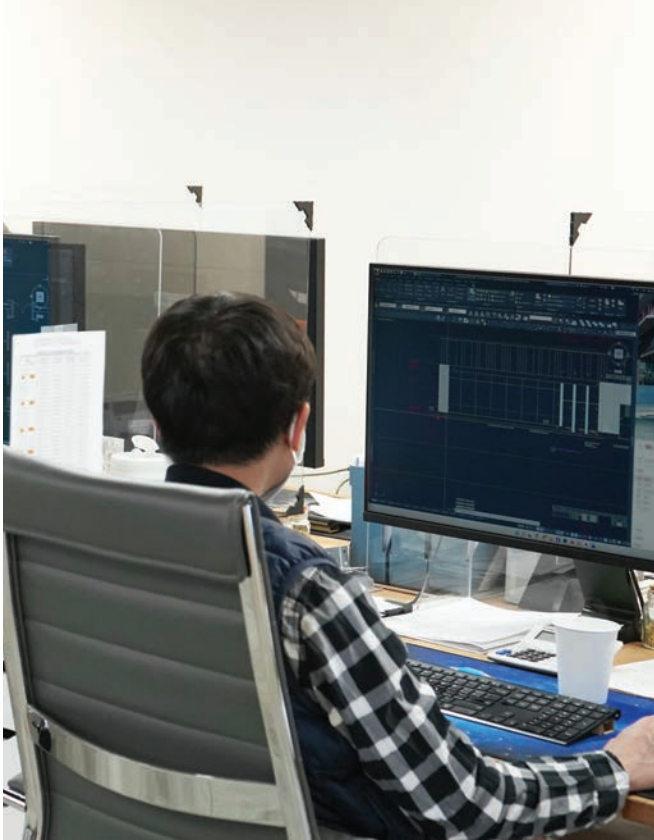

## PANEL INDIVIDUALLY - EDGE CLOSURE

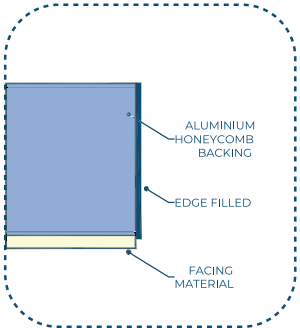

OPTION 1: EDGE FILLED CLOSURE (EF)



OPTION 2: L-FRAME EDGE CLOSURE (LF)

## L-FRAME EDGE CLOSURE OPTIONS (LF)

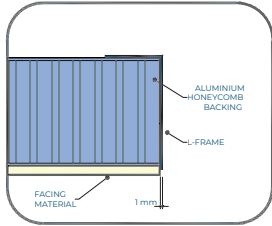
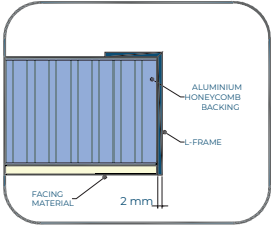
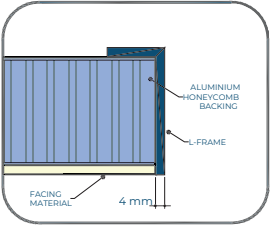
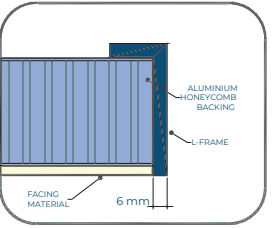
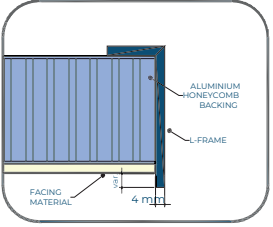
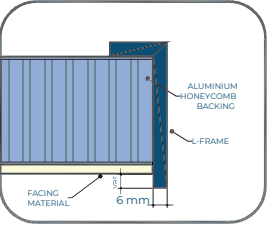
THICKNESS TYPE	1 mm	2 mm	4 mm	6 mm
L-FRAME UP TO THE FACING	 <p><b>COLORS:</b> Black</p> <p><b>LF-1</b></p>			
L-FRAME FACING ALIGN		 <p><b>COLORS:</b> Black White</p> <p><b>LF-2</b></p>	 <p><b>COLORS:</b> Matte Black White Brass Chrome Other colors (TBD)</p> <p><b>LF-4</b></p>	 <p><b>COLORS:</b> Matte Black White Brass Chrome Other colors (TBD)</p> <p><b>LF-6</b></p>
L-FRAME PROTRUDED			 <p><b>COLORS:</b> Matte Black White Brass Chrome Other colors (TBD)</p> <p><b>LFP-4</b></p>	 <p><b>COLORS:</b> Matte Black White Brass Chrome Other colors (TBD)</p> <p><b>LFP-6</b></p>

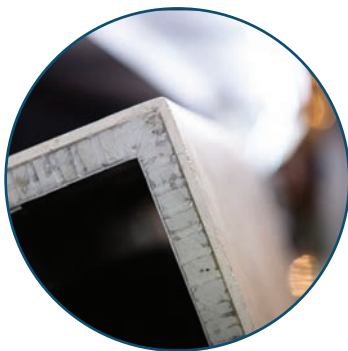

# PANEL TO PANEL WITH PROFILE FRAME

OPTION 1: FACE ALIGNMENT (E1)

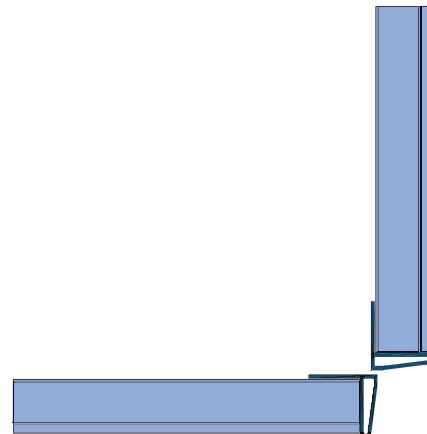
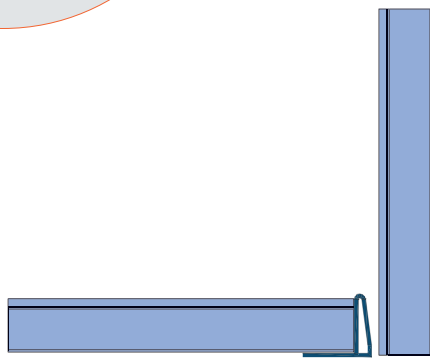
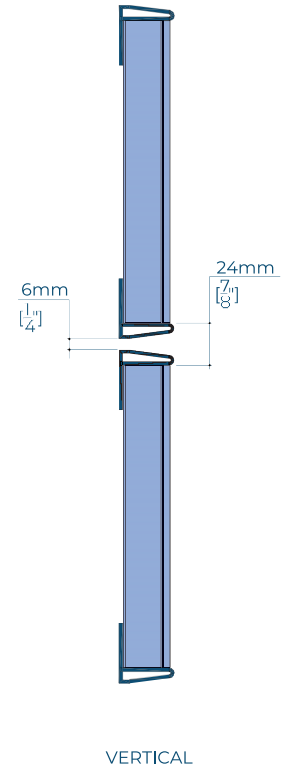
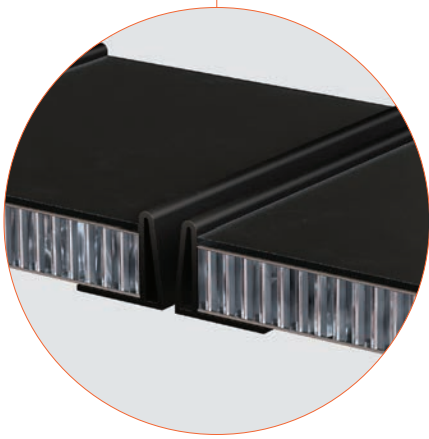
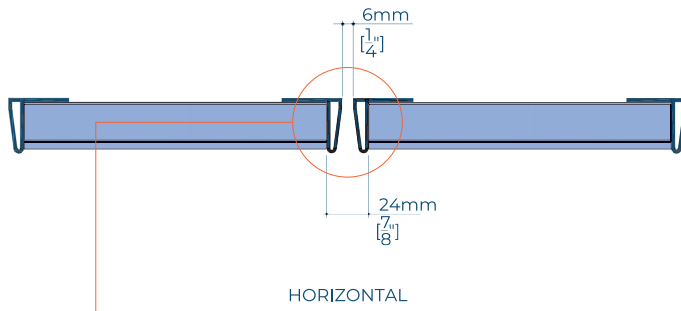



# PANEL TO PANEL WITH PROFILE FRAME

OPTION 1: FACE PROTRUDED (E1-P)

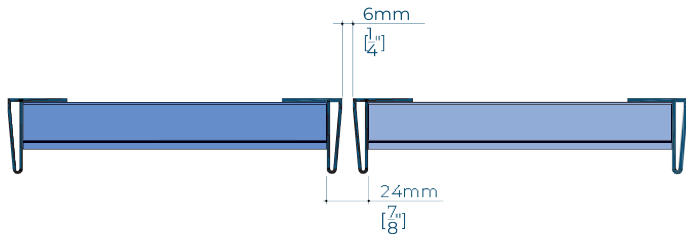

HORIZONTAL

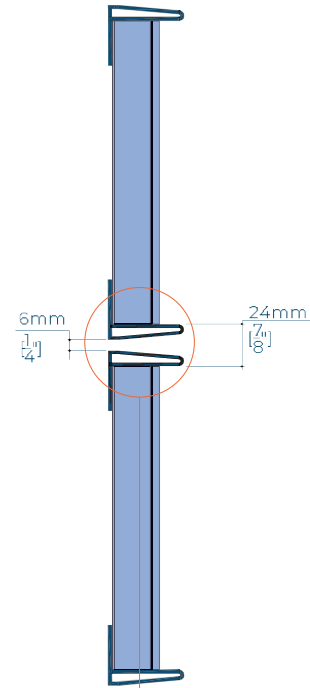

VERTICAL

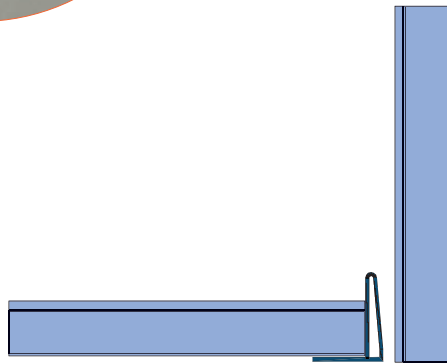

INNER CORNER

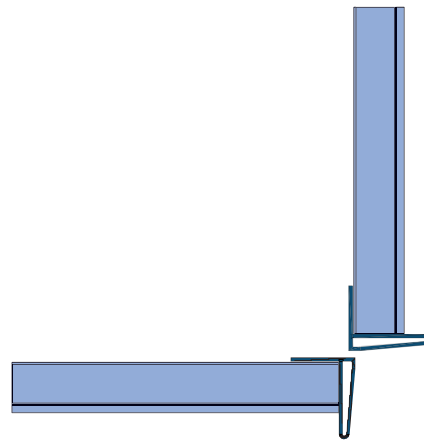

OUTER CORNER

# PANEL TO PANEL WITH PROFILE FRAME

## OPTION 2: FACE ALIGNMENT (E2)

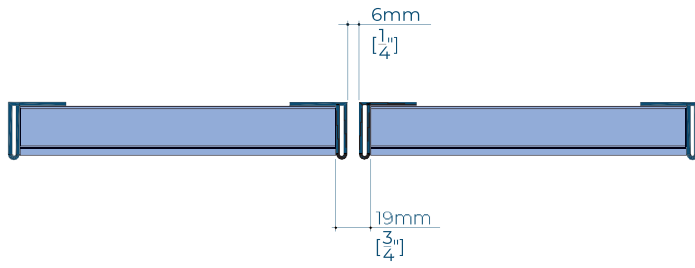

HORIZONTAL

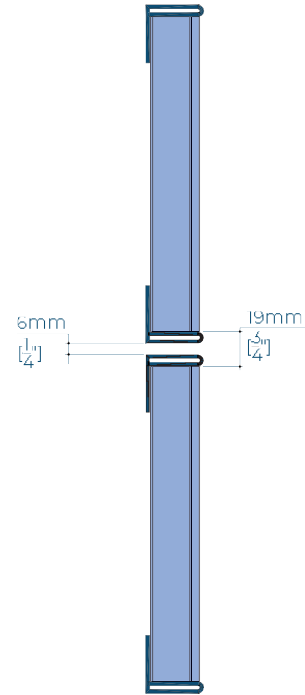

VERTICAL



INNER CORNER

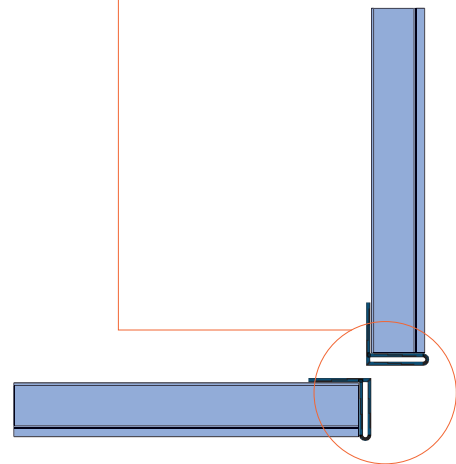

OUTER CORNER

# PANEL TO PANEL WITH PROFILE FRAME

OPTION 2: FACE PROTRUDED (E2-P)

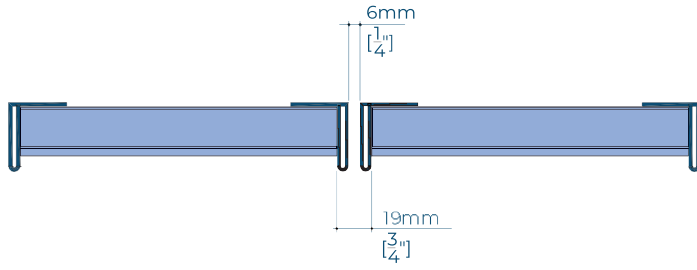

HORIZONTAL

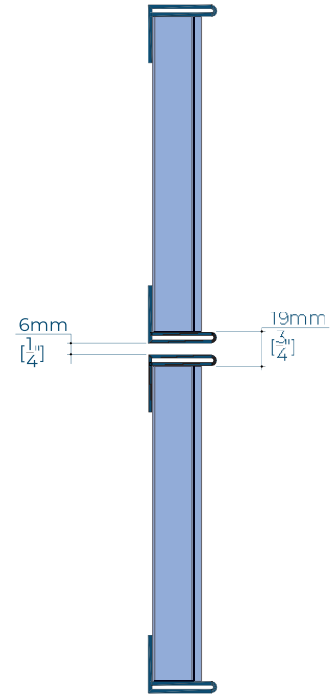

VERTICAL

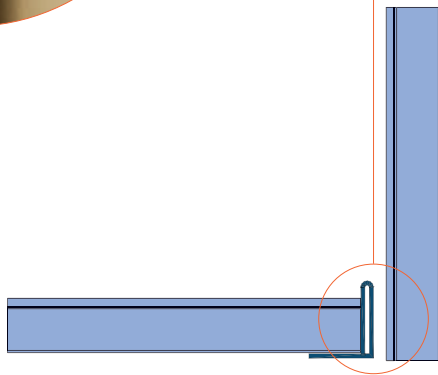

INNER CORNER

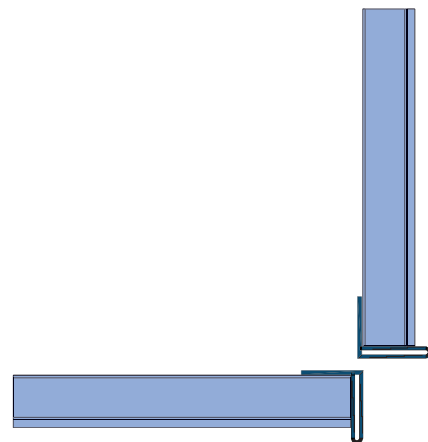

OUTER CORNER

# PANEL TO PANEL WITH PROFILE FRAME

## OPTION 3: FACE ALIGNMENT (E3)

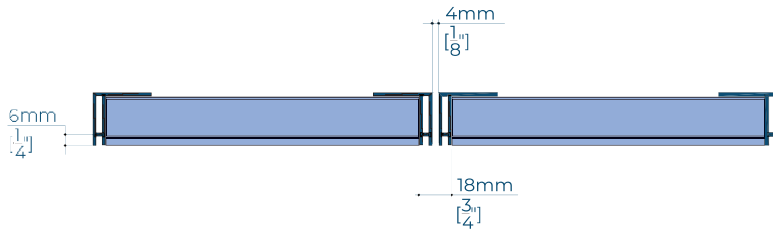

HORIZONTAL

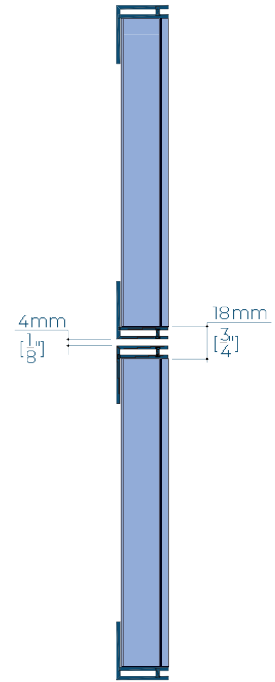

VERTICAL

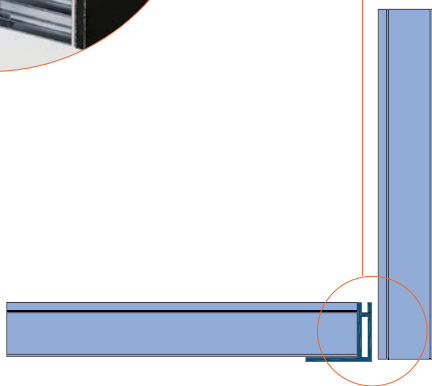

INNER CORNER

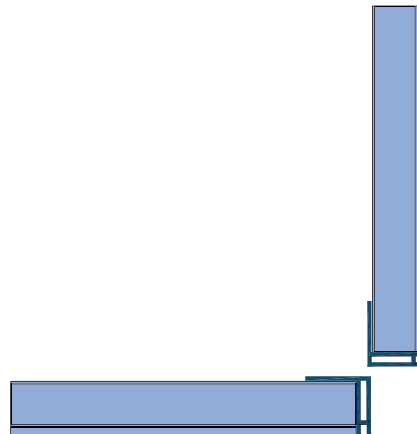

OUTER CORNER

# PANEL TO PANEL WITH PROFILE FRAME

OPTION 3: FACE PROTRUDED (E3-P)

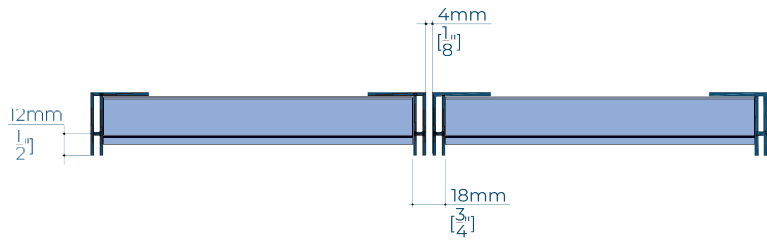

HORIZONTAL

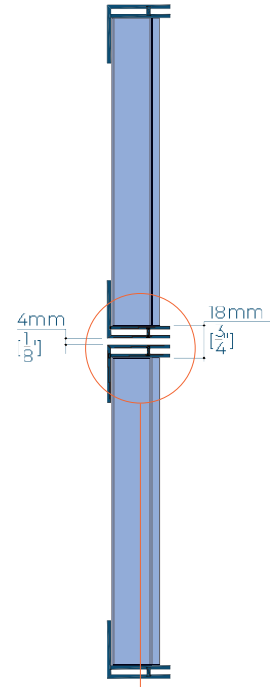

VERTICAL

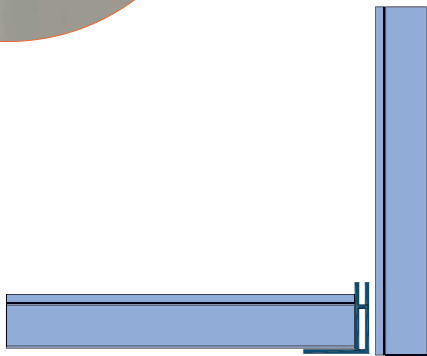

INNER CORNER

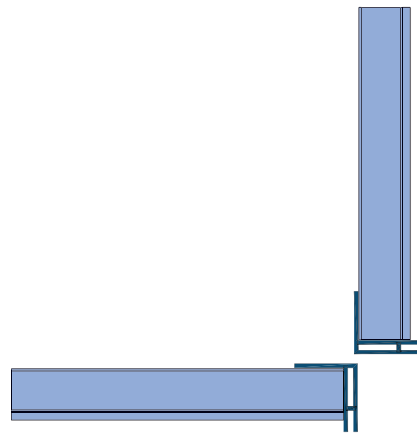

OUTER CORNER

# PANEL TO PANEL WITH PROFILE FRAME

## OPTION 4: FACE ALIGNMENT (E4)

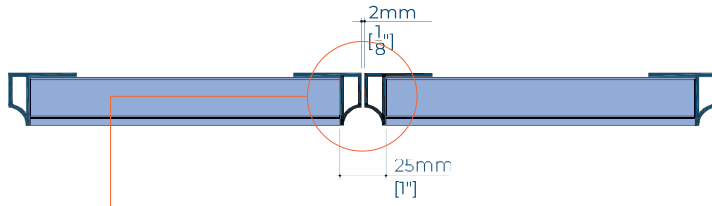

HORIZONTAL

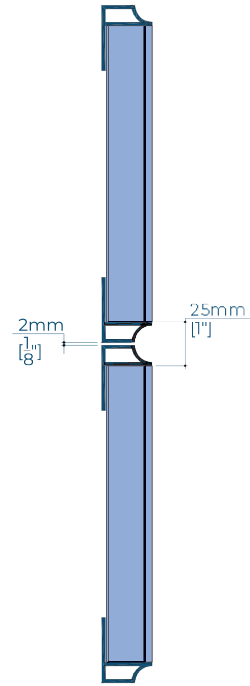

VERTICAL

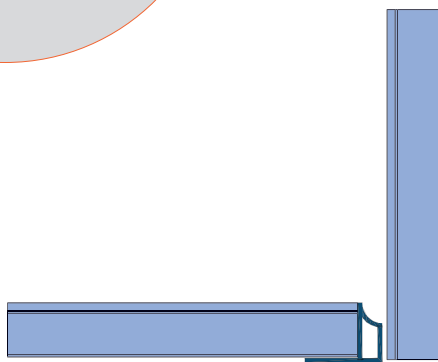
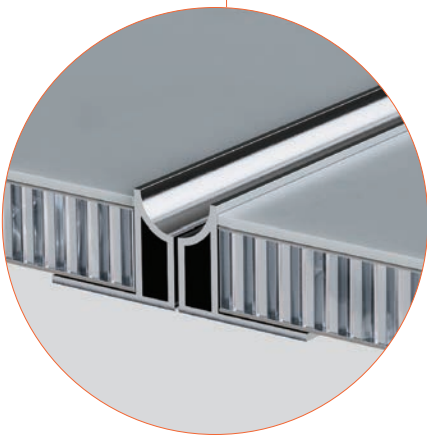

INNER CORNER

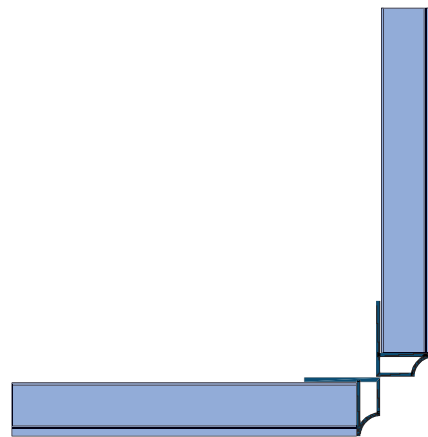

OUTER CORNER



# PANEL TO PANEL WITH PROFILE FRAME

OPTION 4: FACE PROTRUDED (E4-P)

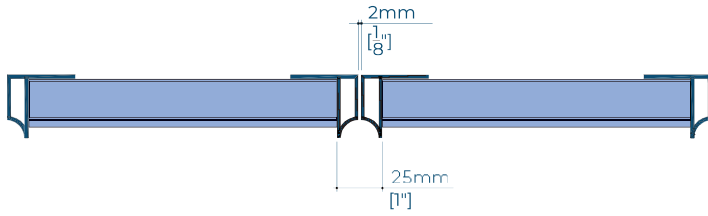

HORIZONTAL

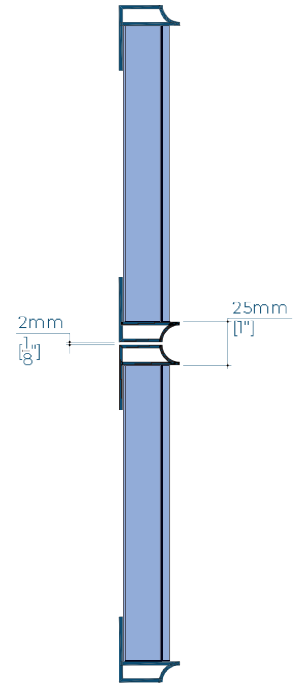

VERTICAL

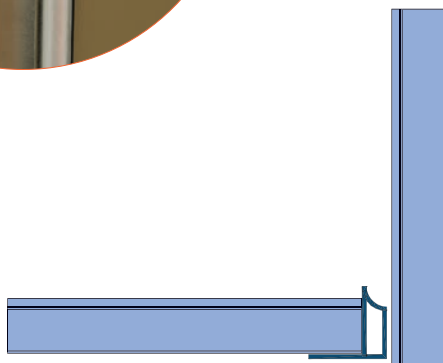
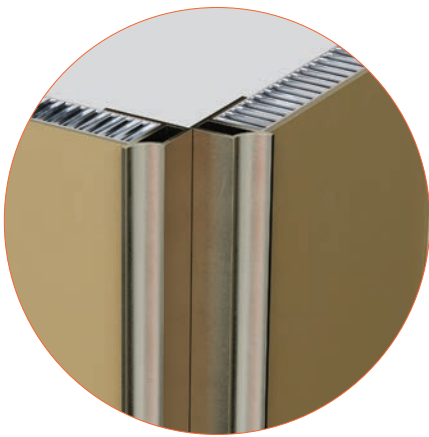

INNER CORNER

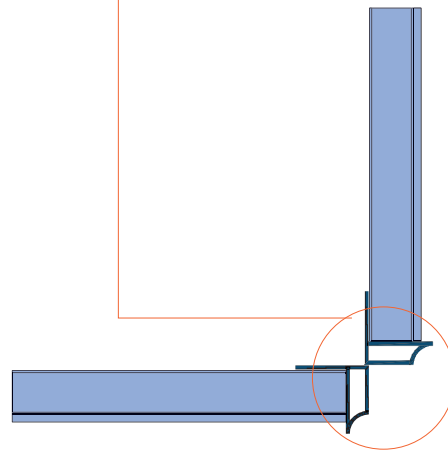

OUTER CORNER

# PANEL TO PANEL WITH PROFILE FRAME

## OPTION 5: FACE ALIGNMENT (E5)

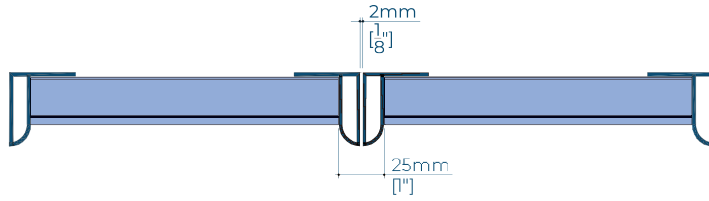

HORIZONTAL

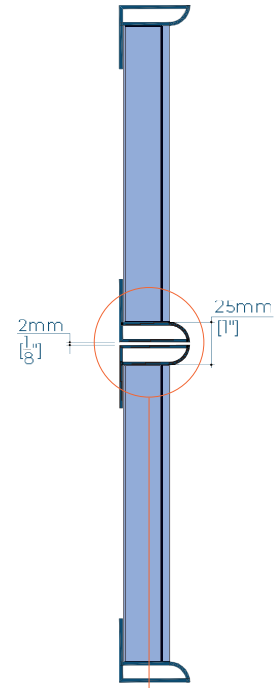

VERTICAL

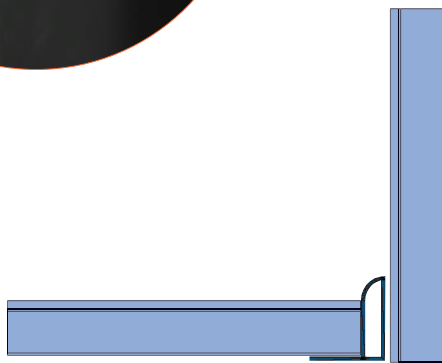

INNER CORNER

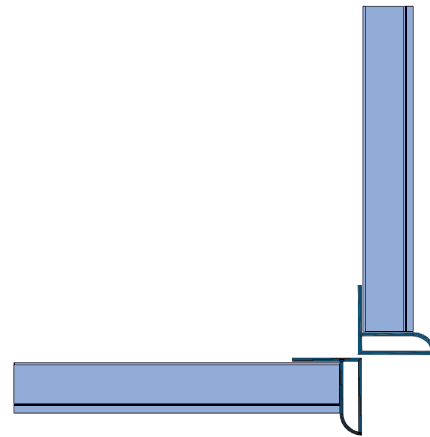

OUTER CORNER

## PANEL TO PANEL WITH PROFILE FRAME

OPTION 5: FACE PROTRUDED (E5-P)

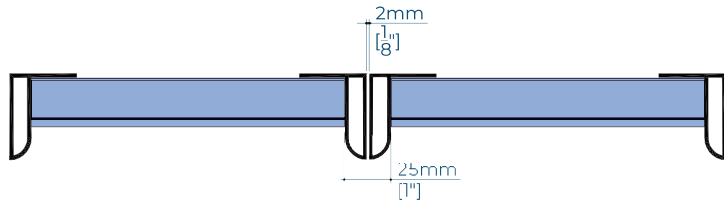

HORIZONTAL

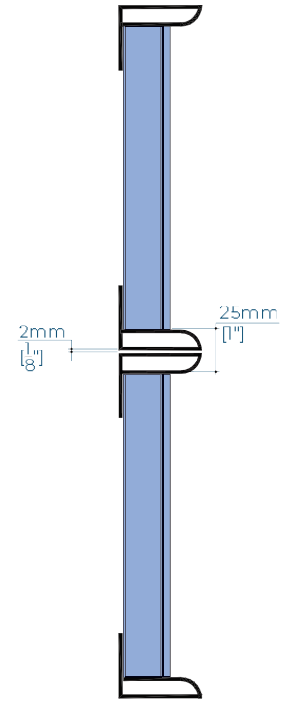

VERTICAL

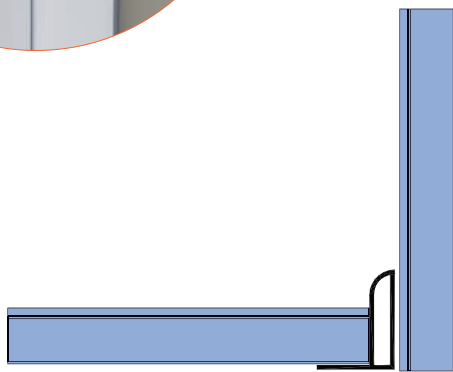

INNER CORNER

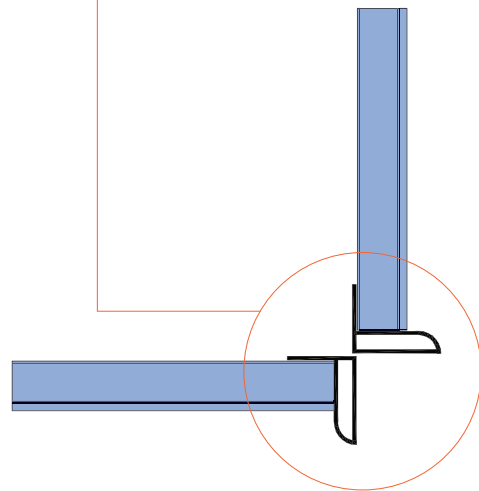

OUTER CORNER

# PANEL TO PANEL WITH PROFILE FRAME

## OPTION 6: FACE ALIGNMENT (E6)

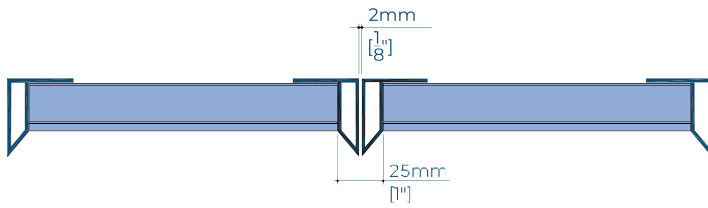

HORIZONTAL

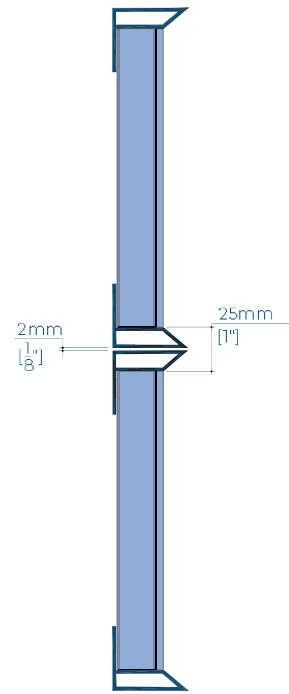

VERTICAL

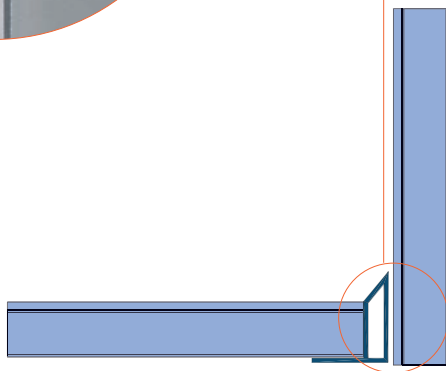
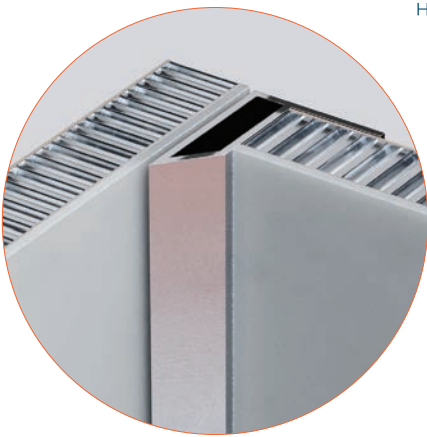

INNER CORNER

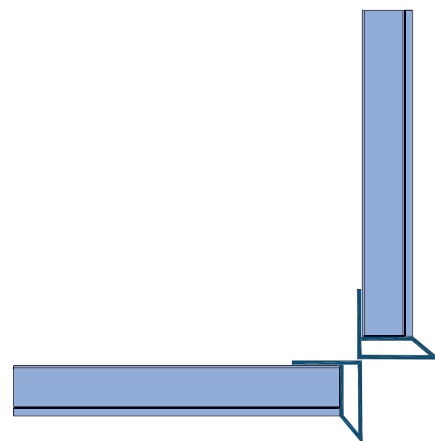

OUTER CORNER

# PANEL TO PANEL WITH PROFILE FRAME

OPTION 6: FACE PROTRUDED (E6-P)

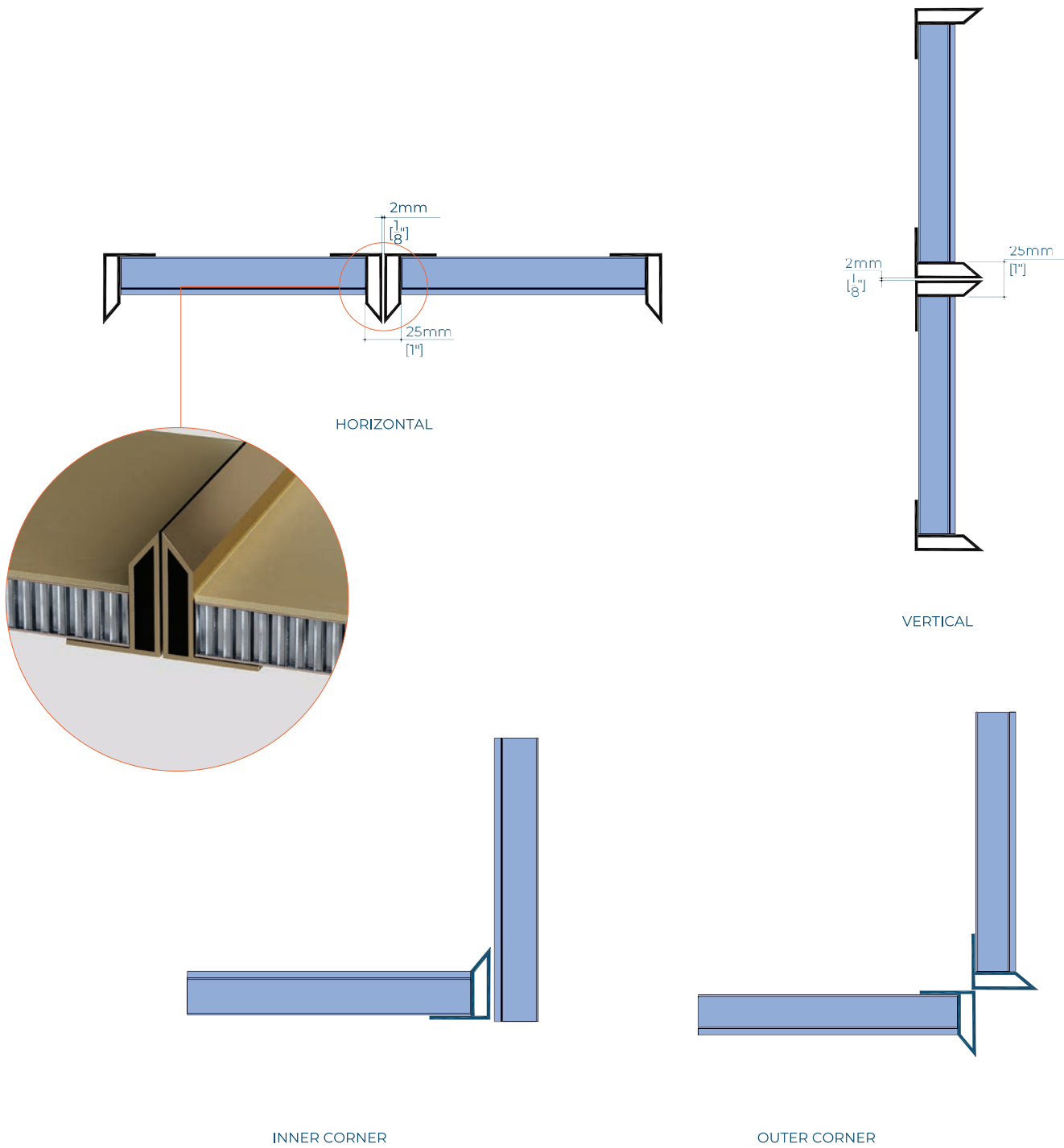

# PANEL TO PANEL WITH PROFILE FRAME

## OPTION 7: FACE ALIGNMENT (E7)

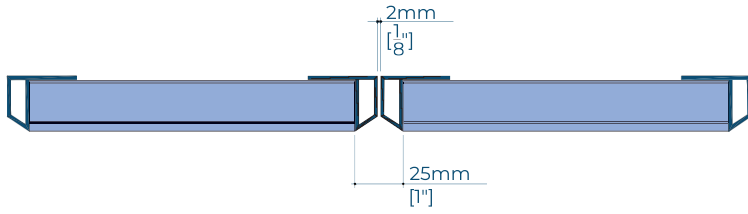

HORIZONTAL

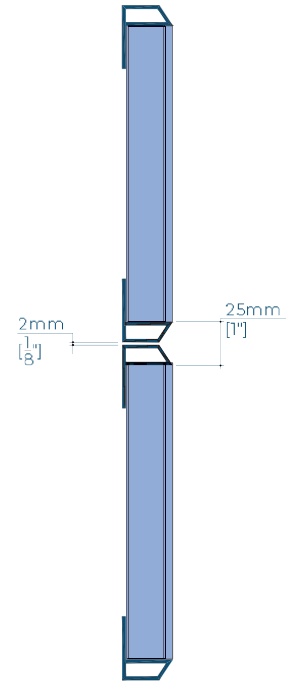

VERTICAL

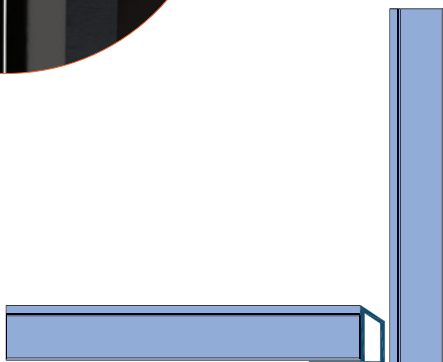
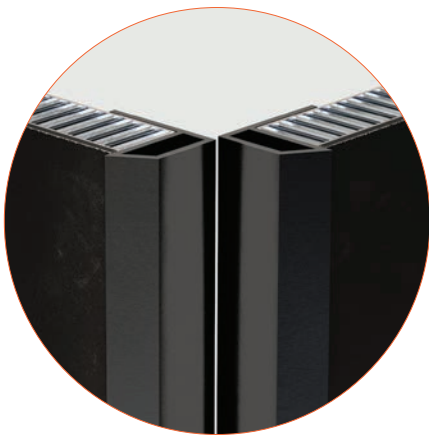

INNER CORNER

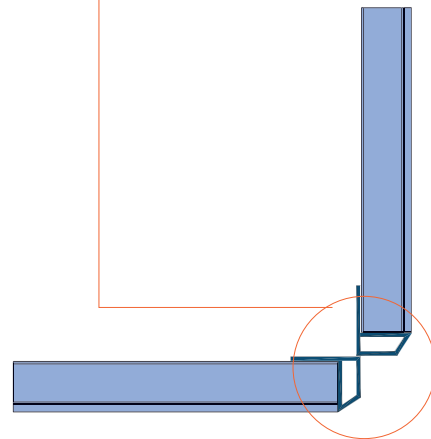

OUTER CORNER



# PANEL TO PANEL WITH PROFILE FRAME

OPTION 7: FACE PROTRUDED (E7-P)

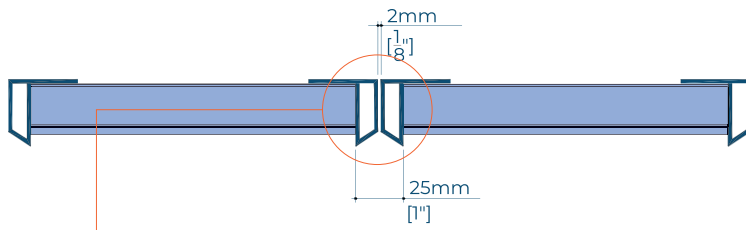

HORIZONTAL

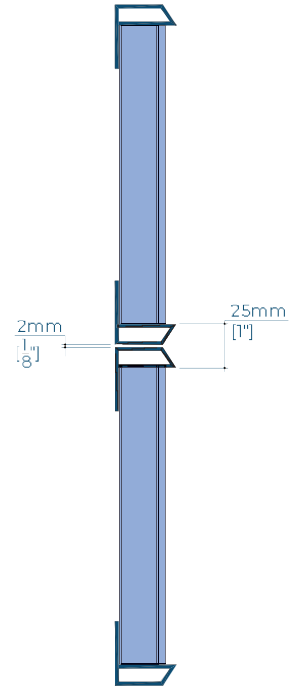

VERTICAL

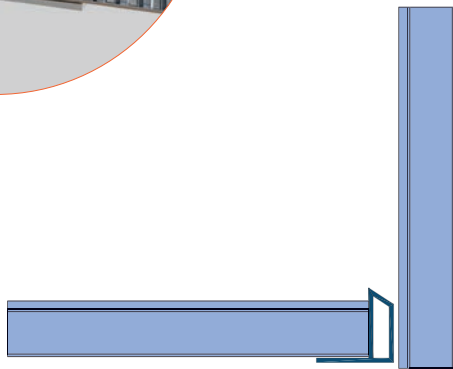
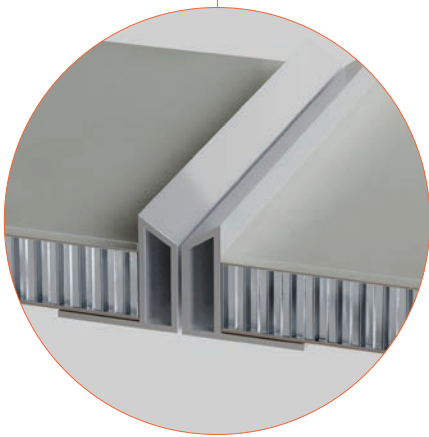

INNER CORNER

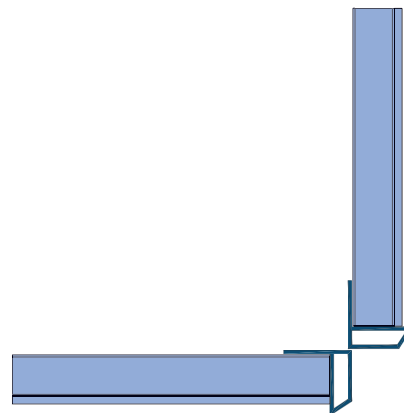

OUTER CORNER

## TERMINATION TO OTHER MATERIALS

### METAL FLASHING

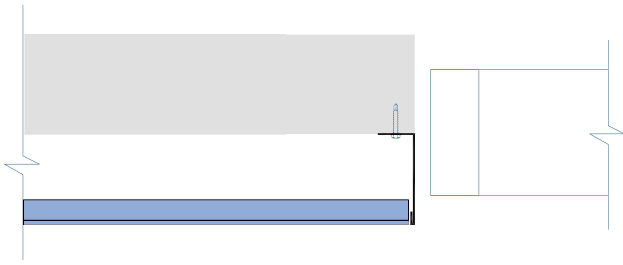

MF-1

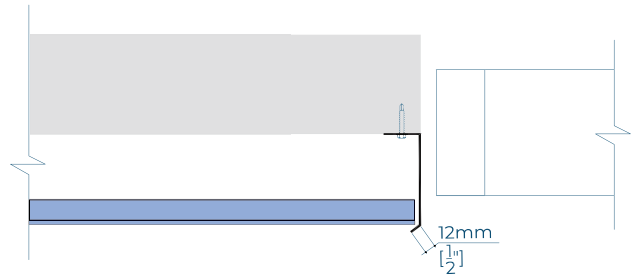

MF-2

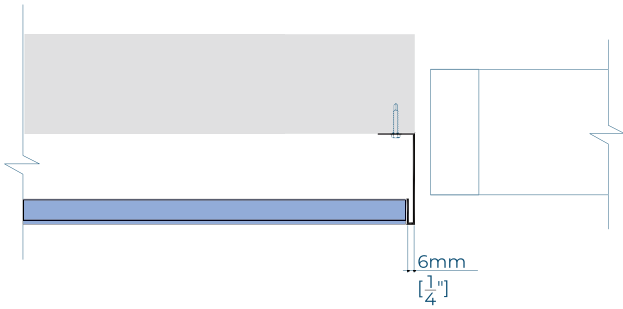

MF-3

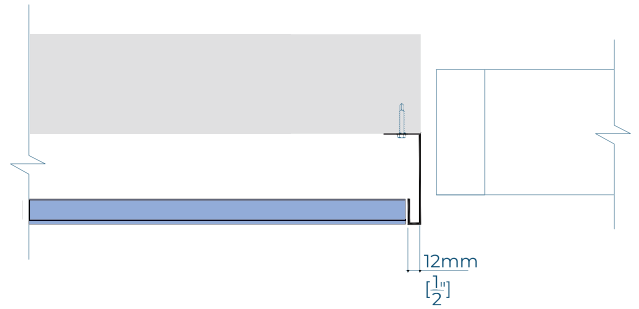

MF-4



## TERMINATION TO OTHER MATERIALS

### PANEL RETURNS

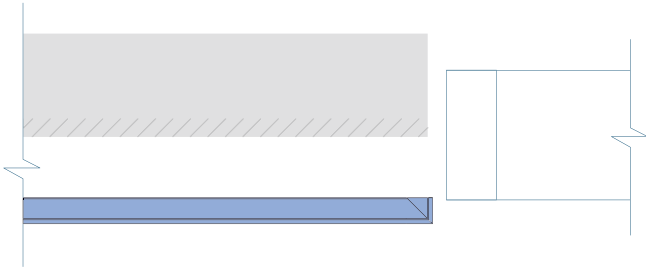

PR-1

PANEL RETURN - RETURN TO THE PANEL

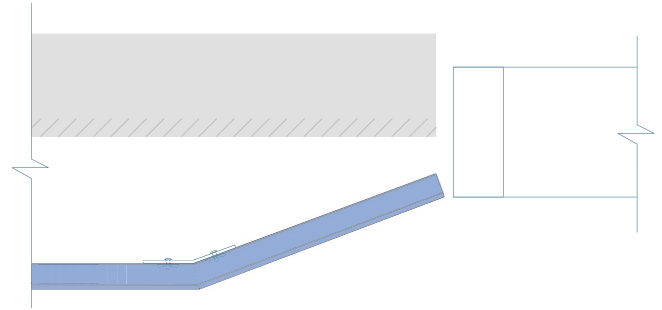

PR-3

PANEL RETURN - ANGLED

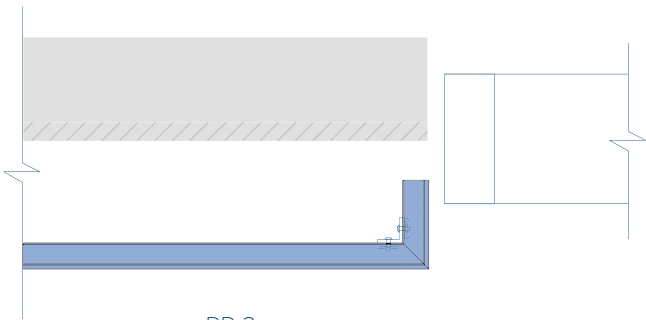

PR-2

PANEL RETURN - 90

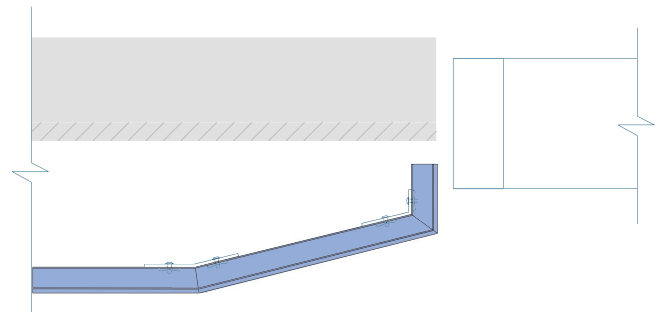

PR-4

PANEL RETURN-ANGLED

# PANEL METAL ACCENT

## OPTION 1: FACE ALIGNMENT (A)

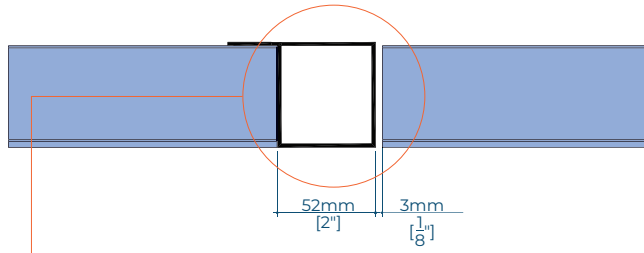

HORIZONTAL

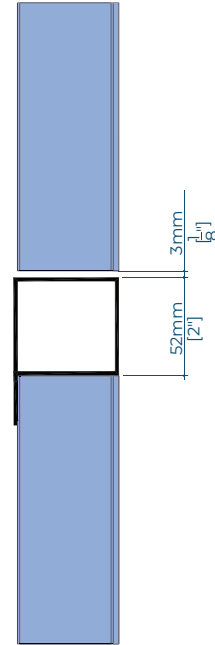

VERTICAL

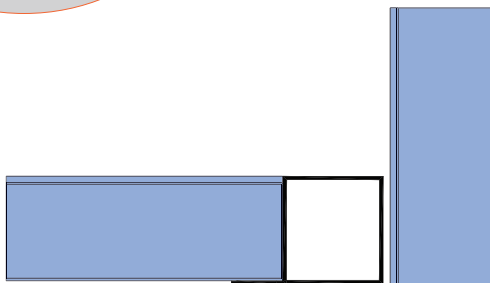
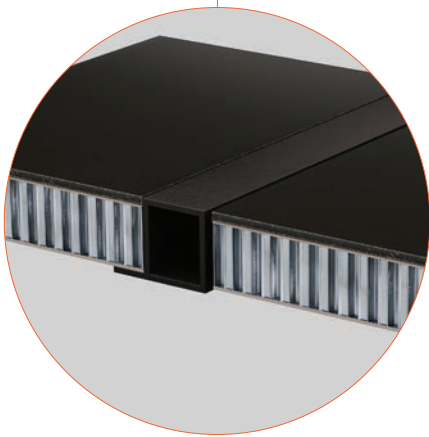

INNER CORNER

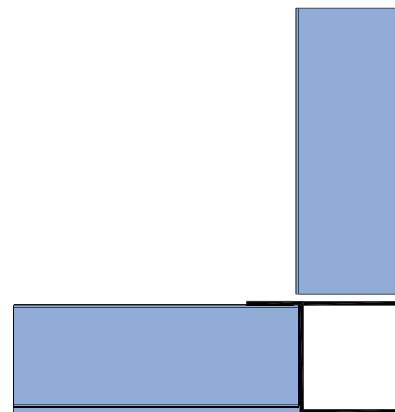

OUTER CORNER

# PANEL METAL ACCENT

## OPTION 1: FACE PROTRUDED (A1-P)

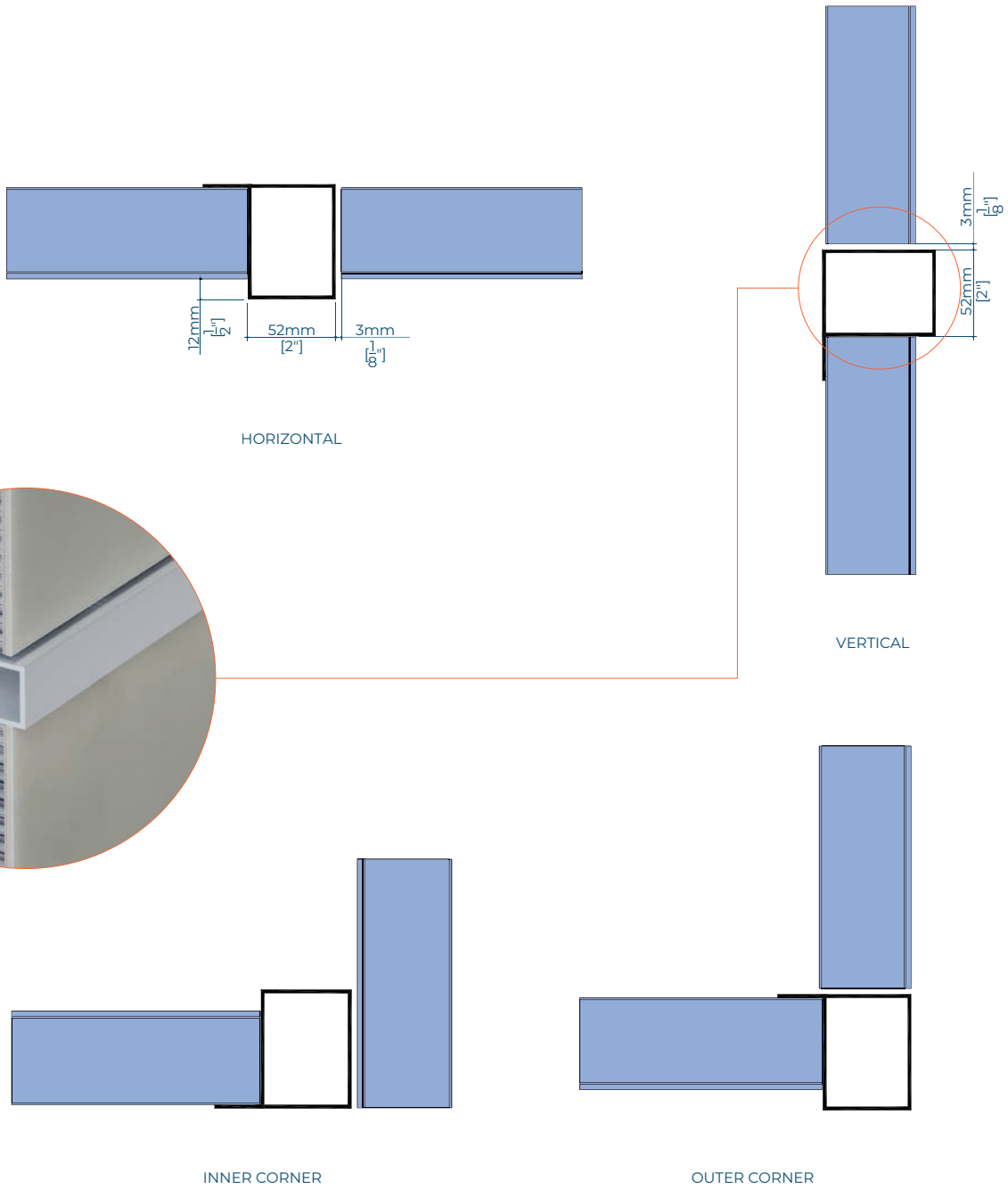

# PANEL METAL ACCENT

## OPTION 2: FACE ALIGNMENT (A2)

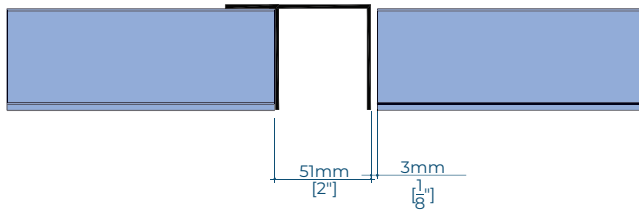

HORIZONTAL

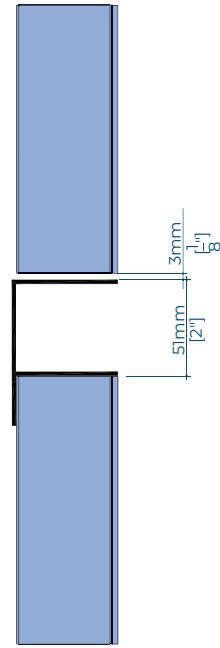

VERTICAL

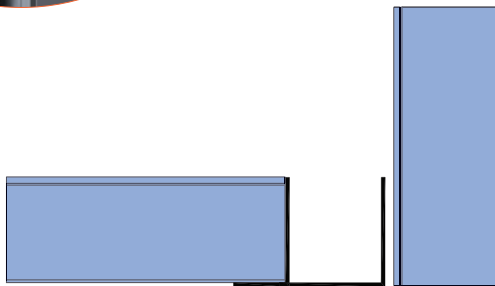

INNER CORNER

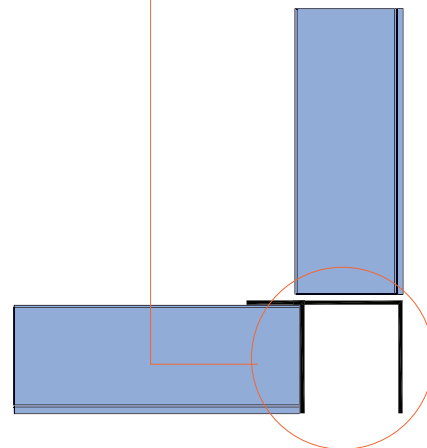

OUTER CORNER



# PANEL METAL ACCENT

## OPTION 2: FACE PROTRUDED (A2-P)

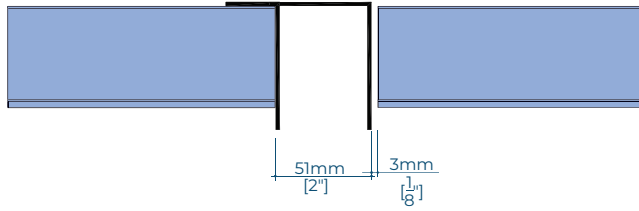

HORIZONTAL

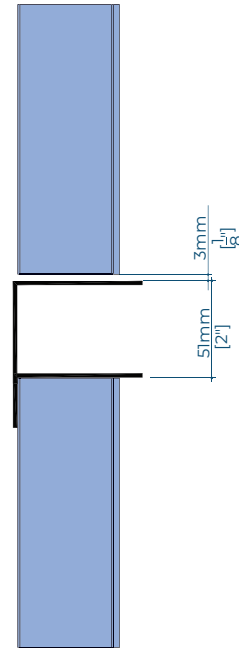

VERTICAL

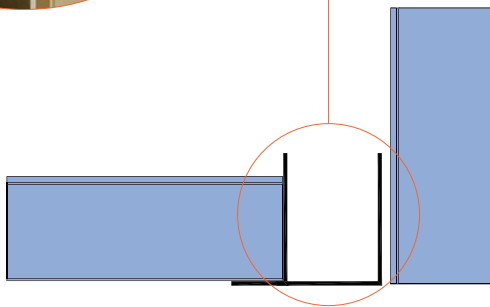

INNER CORNER

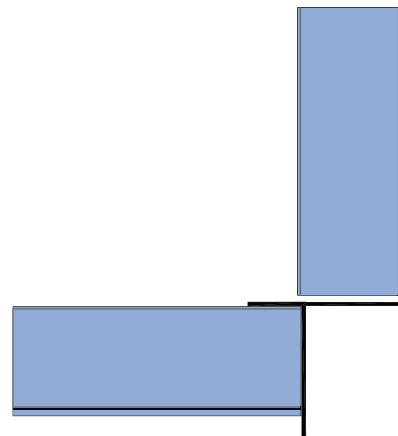

OUTER CORNER

PANEL METAL ACCENT

OPTION 3: FACE ALIGNMENT (A3)

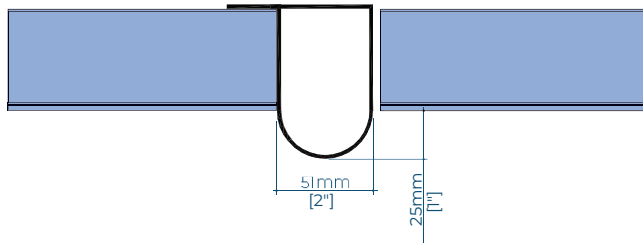

HORIZONTAL

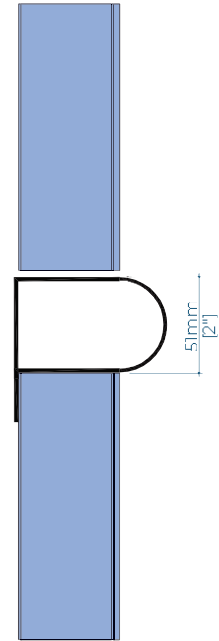

VERTICAL

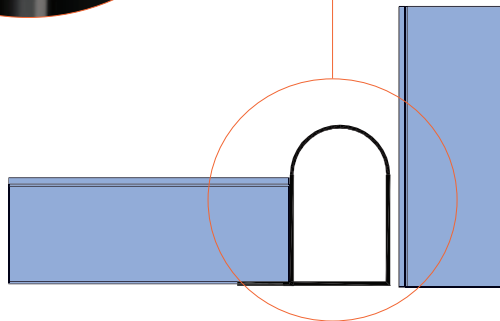
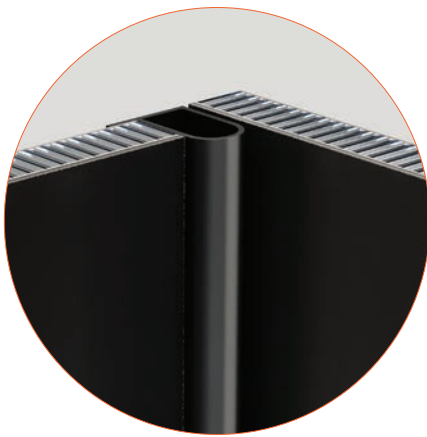

INNER CORNER

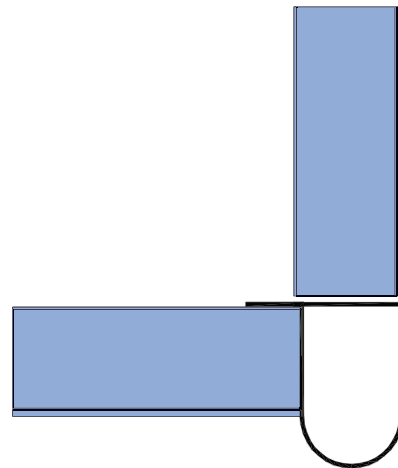

OUTER CORNER

# PANEL METAL ACCENT

## OPTION 3: FACE PROTRUDED (A3-P)

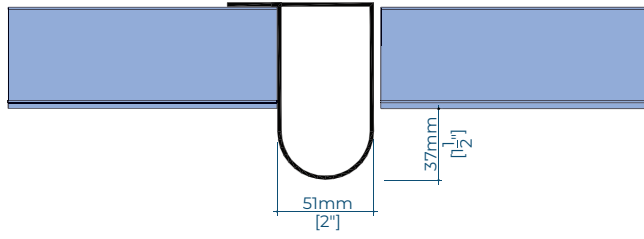

HORIZONTAL

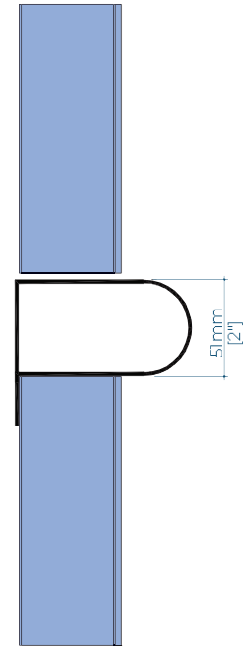

VERTICAL

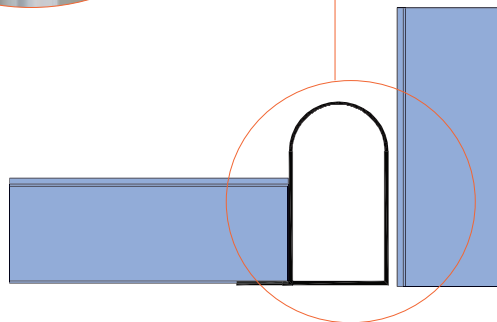

INNER CORNER

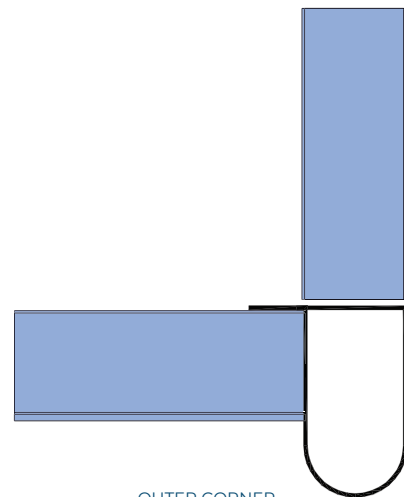

OUTER CORNER

# PANEL METAL ACCENT

## OPTION 4: FACE ALIGNMENT (A4)

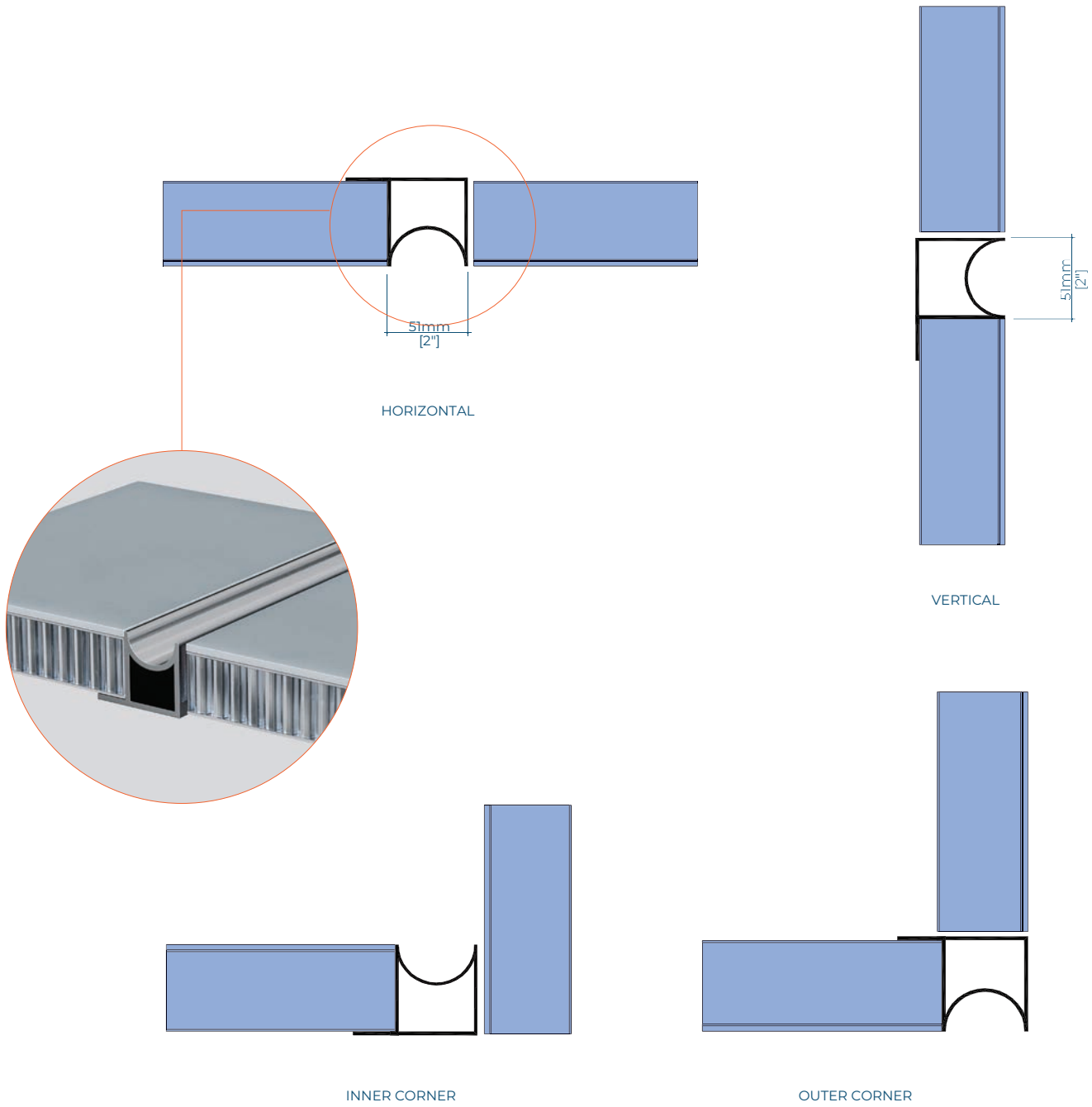

# PANEL METAL ACCENT

## OPTION 4: FACE PROTRUDED (A4-P)

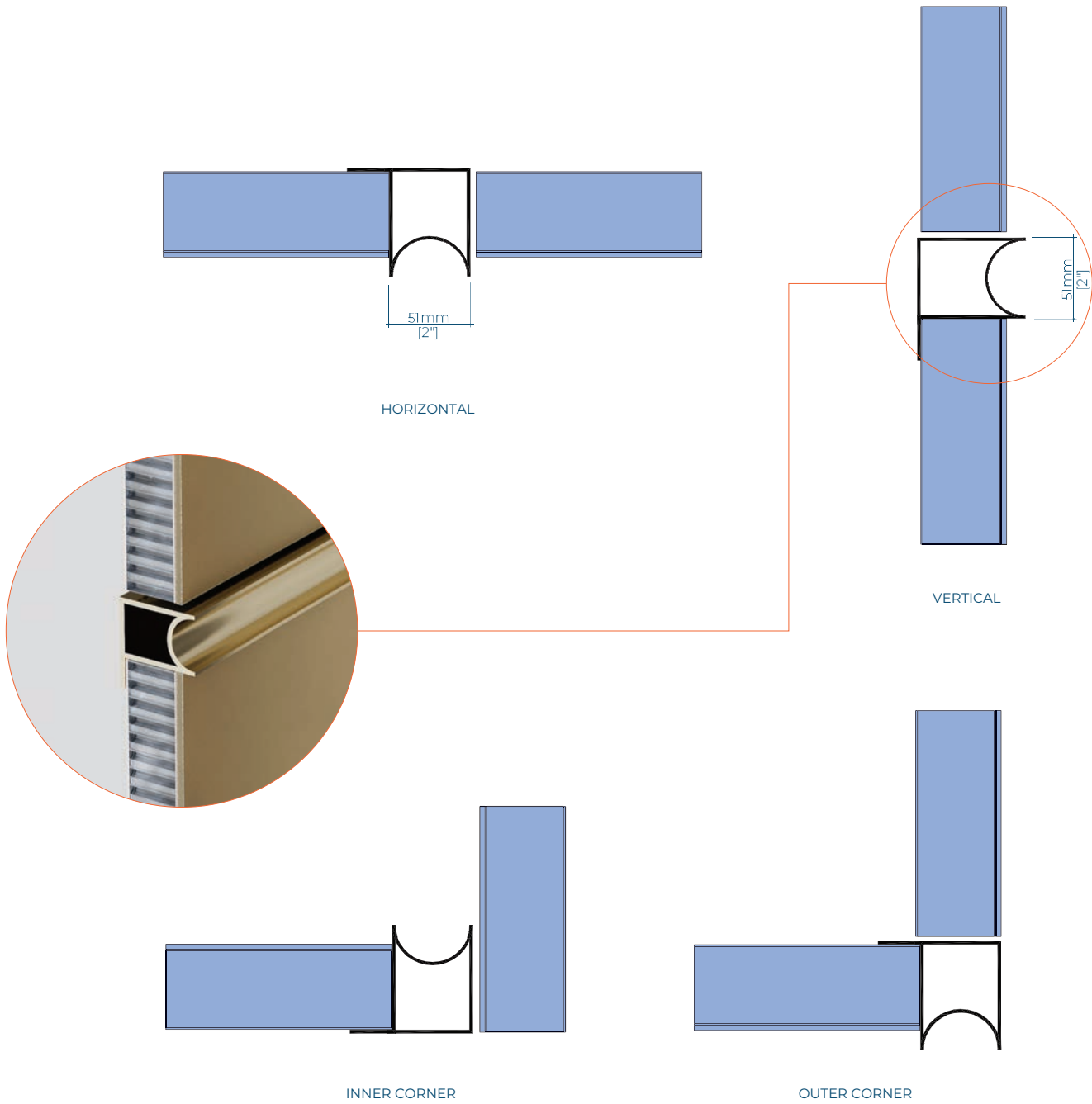

# PANEL METAL ACCENT

## OPTION 5: FACE ALIGNMENT (A5)

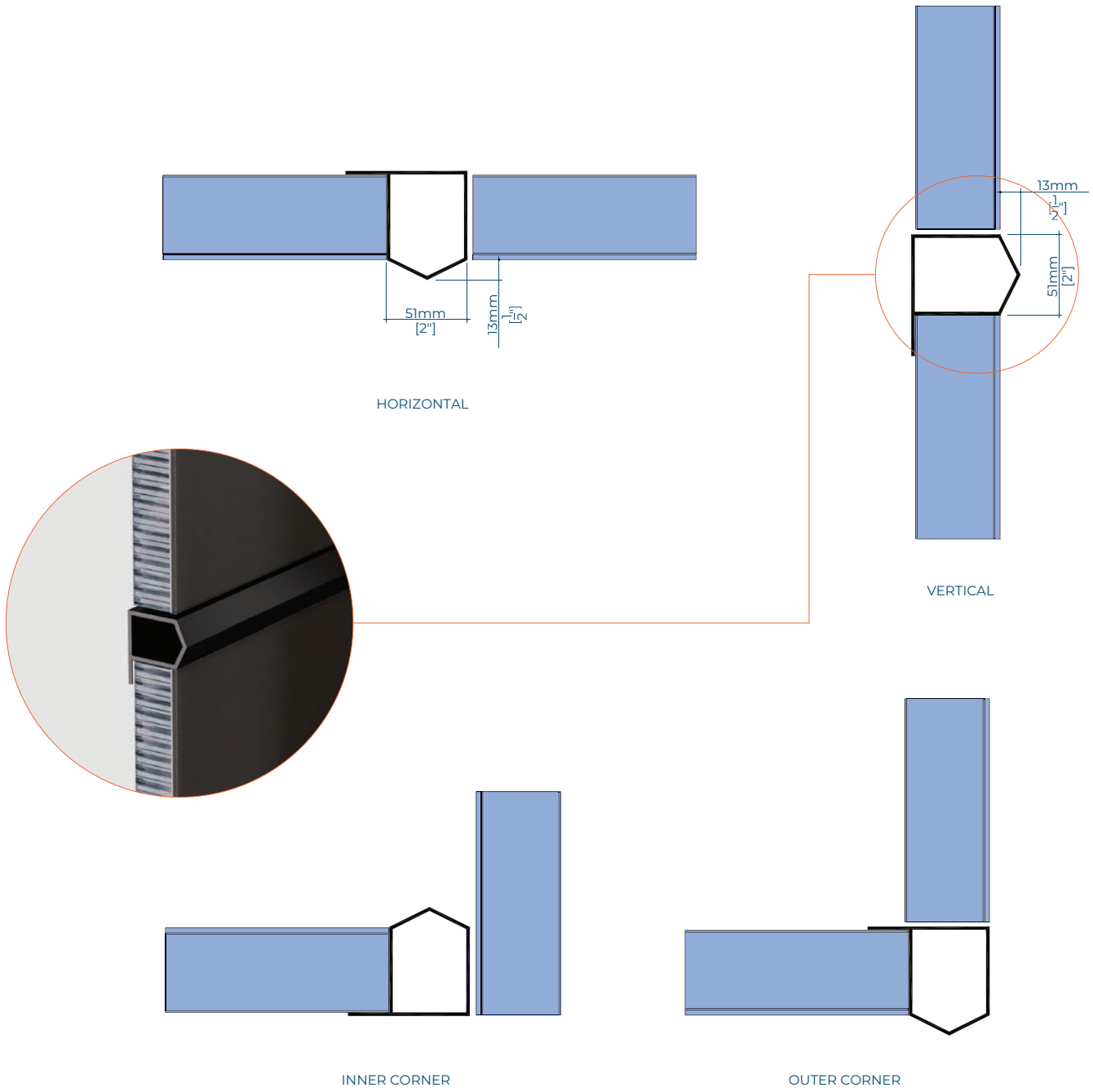



# PANEL METAL ACCENT

## OPTION 5: FACE PROTRUDED (A5-P)

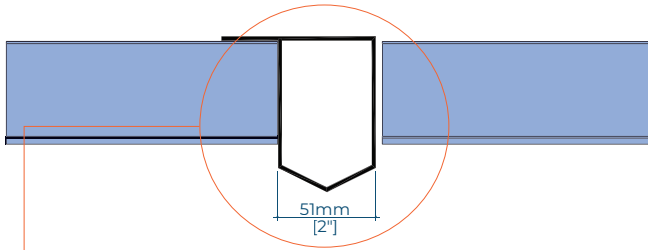

HORIZONTAL

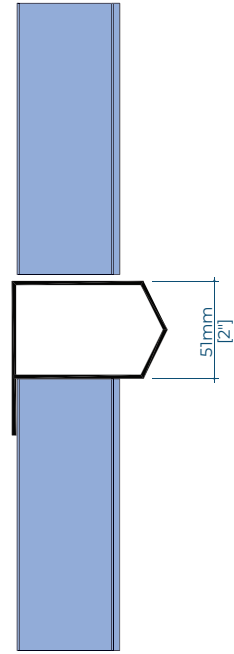

VERTICAL

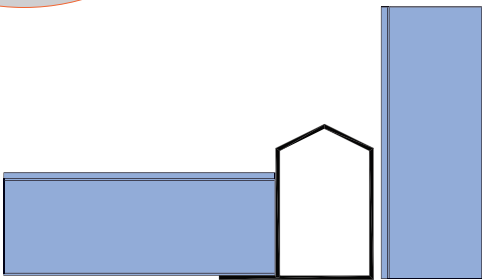
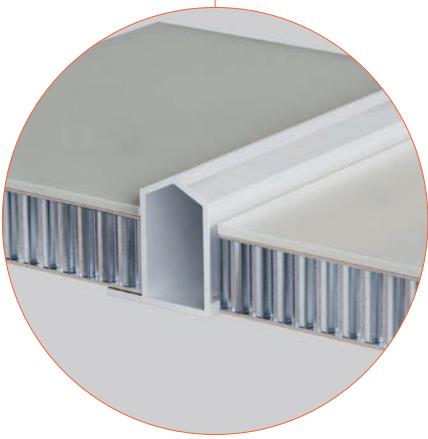

INNER CORNER

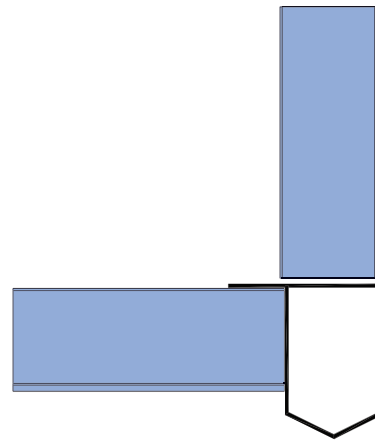

OUTER CORNER

# PANEL METAL ACCENT

## OPTION 6: FACE ALIGNMENT (A6)

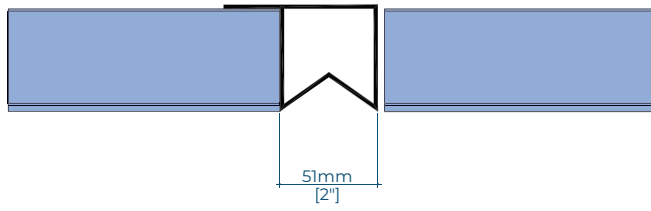

HORIZONTAL

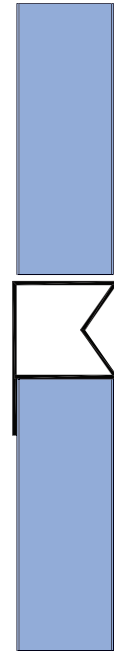

VERTICAL

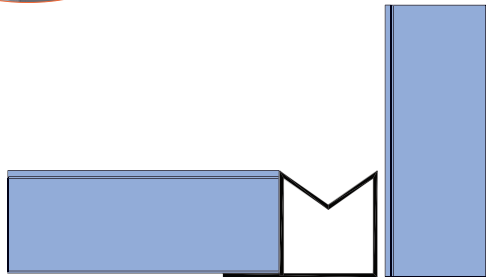
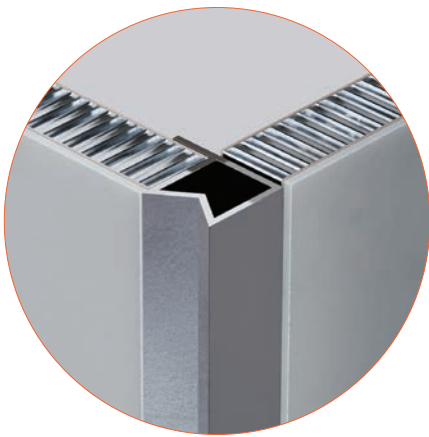

INNER CORNER

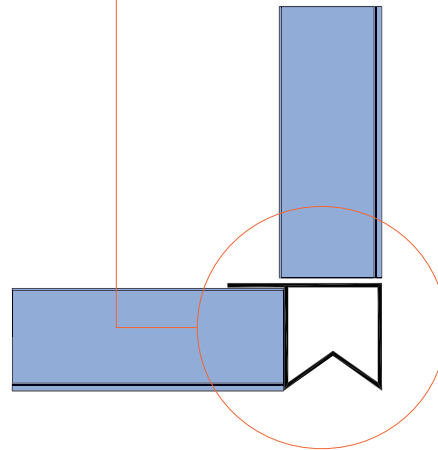

OUTER CORNER

# PANEL METAL ACCENT

## OPTION 6: FACE PROTRUDED (A6-P)

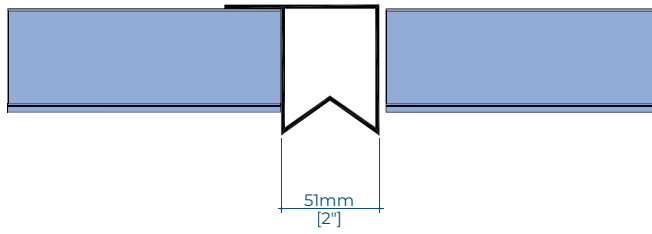

HORIZONTAL

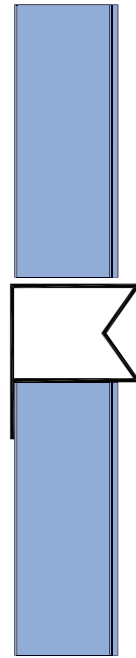

VERTICAL

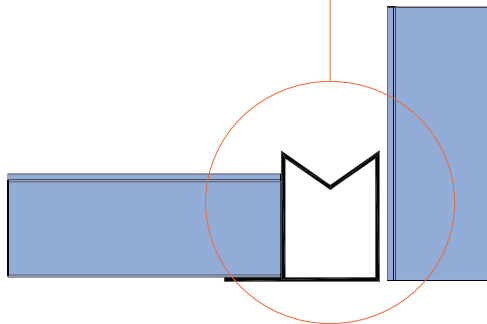
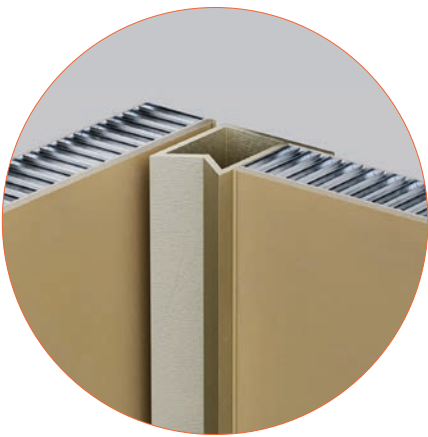

INNER CORNER

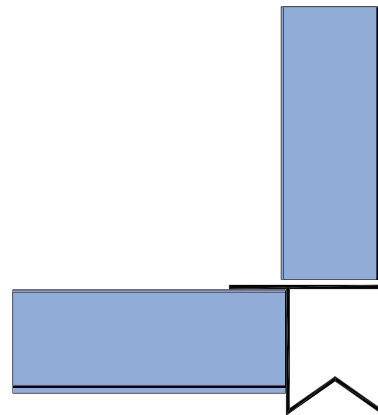

OUTER CORNER

# PANEL METAL ACCENT

## OPTION 7: FACE ALIGNMENT (A7)

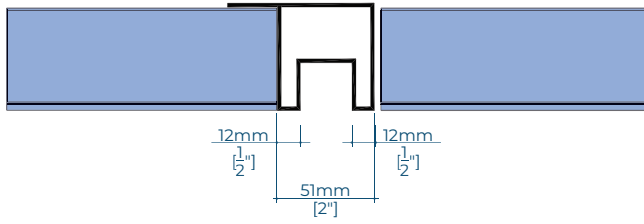

HORIZONTAL

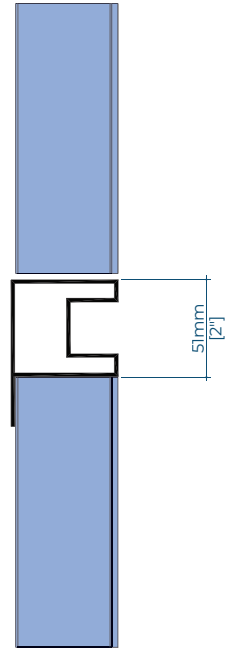

VERTICAL

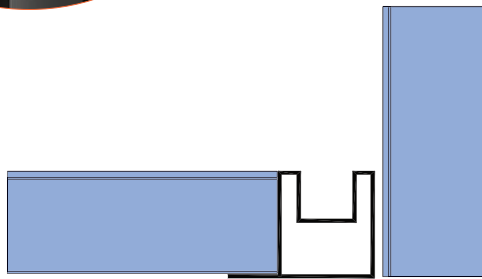
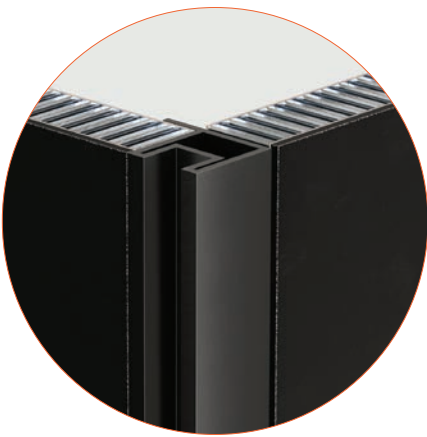

INNER CORNER

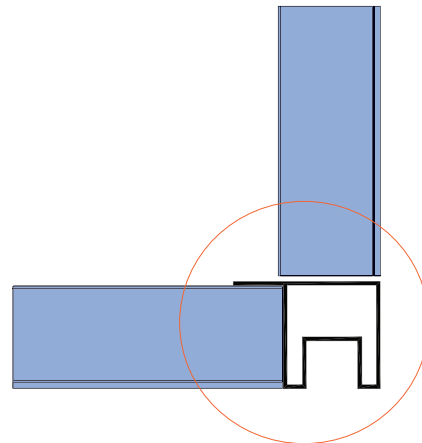

OUTER CORNER

# PANEL METAL ACCENT

## OPTION 7: FACE PROTRUDED (A7-P)

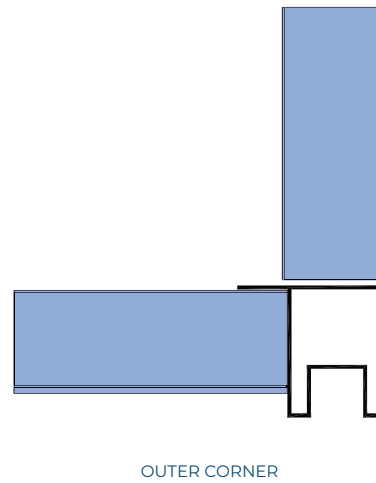
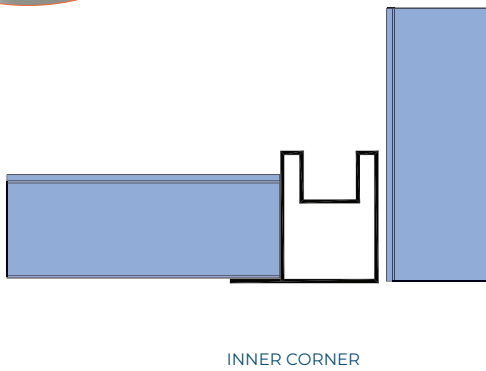
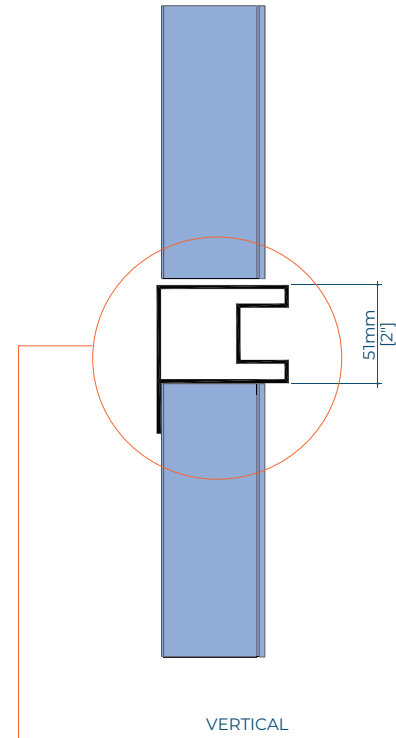
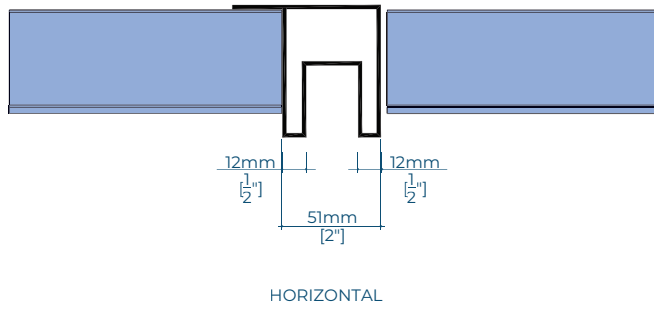

# PANEL METAL ACCENT

## OPTION 8: FACE ALIGNMENT (A8)

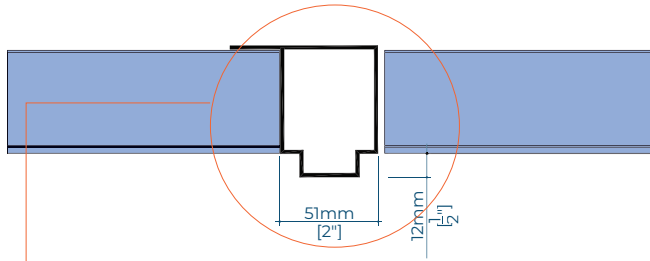

HORIZONTAL

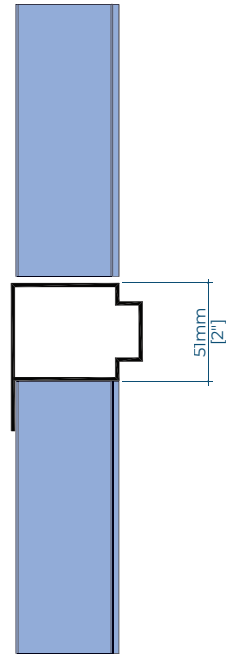

VERTICAL

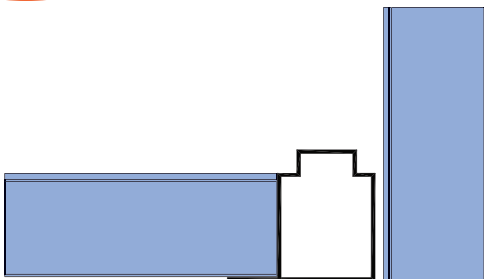
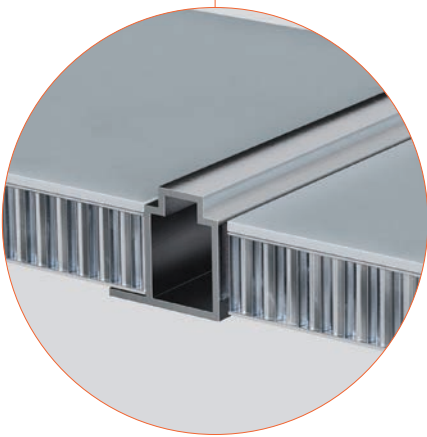

INNER CORNER

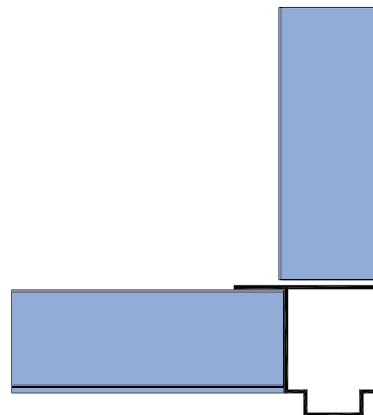

OUTER CORNER

# PANEL METAL ACCENT

## OPTION 8: FACE PROTRUDED (A8-P)

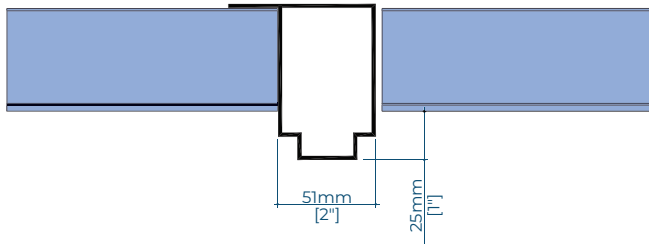

HORIZONTAL

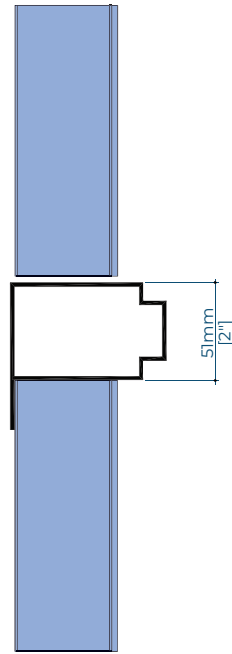

VERTICAL

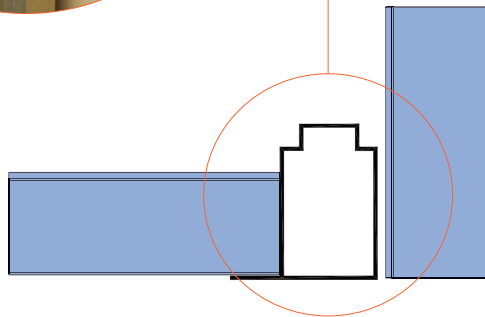
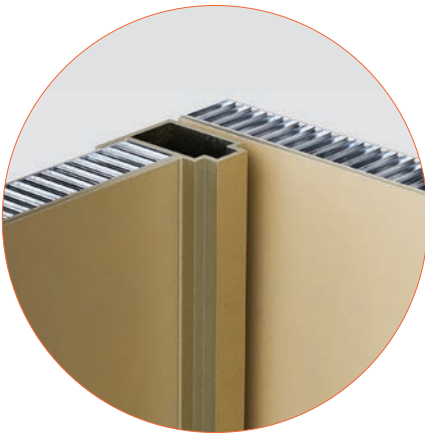

INNER CORNER

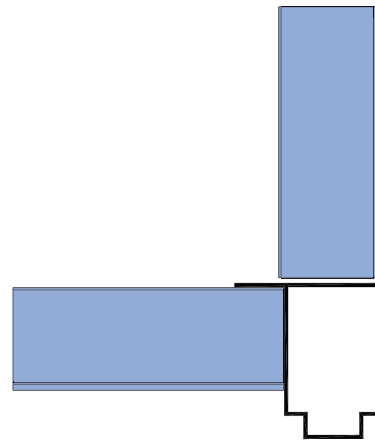

OUTER CORNER

# PANEL METAL ACCENT

## OPTION 9: FACE ALIGNMENT (A9)

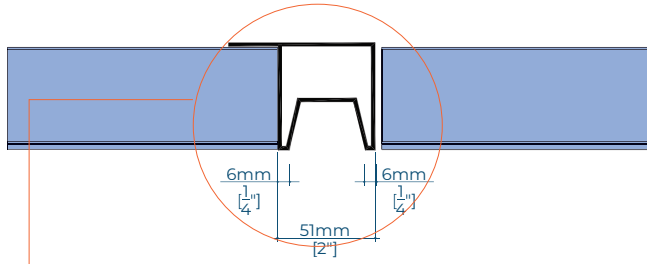

HORIZONTAL

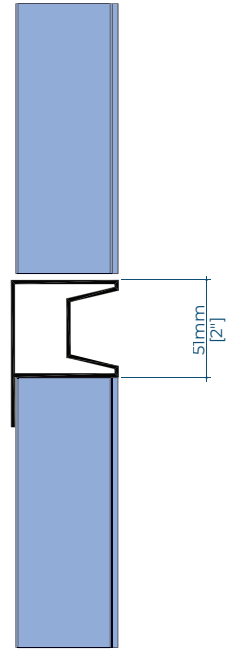

VERTICAL

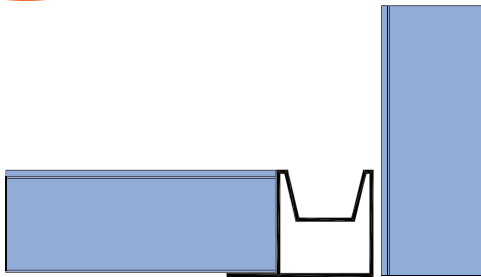
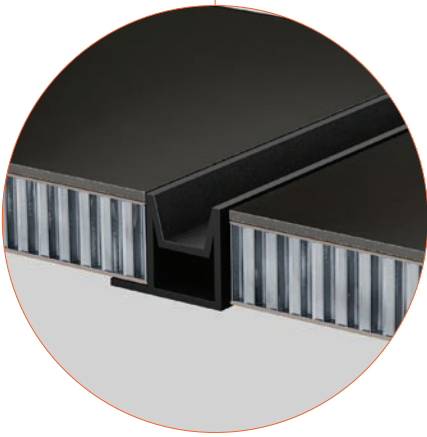

INNER CORNER

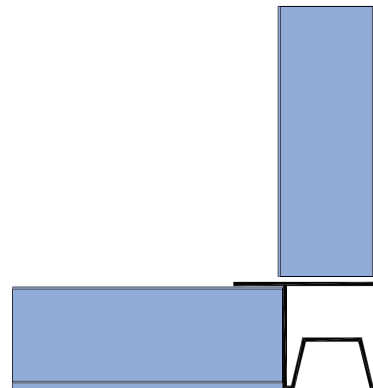

OUTER CORNER



# PANEL METAL ACCENT

## OPTION 9: FACE PROTRUDED (A9-P)

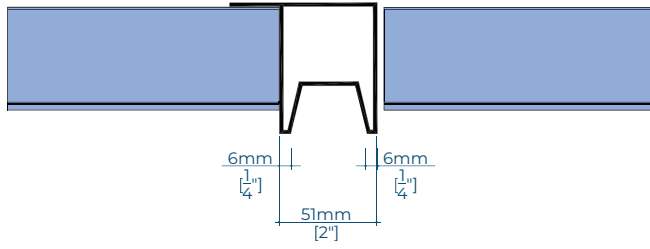

HORIZONTAL

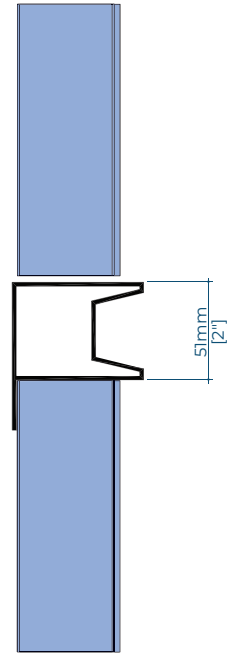

VERTICAL

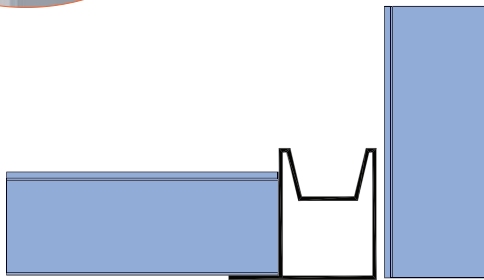

INNER CORNER

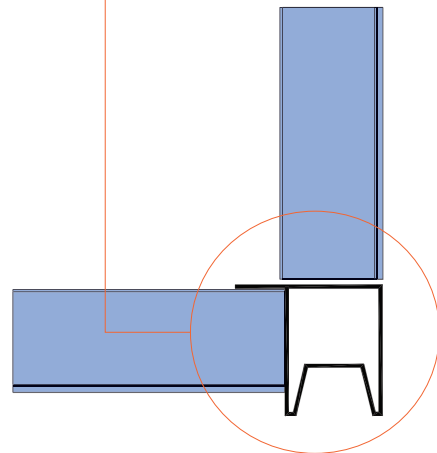

OUTER CORNER

# PANEL METAL ACCENT

## OPTION 10: FACE ALIGNMENT (A10)

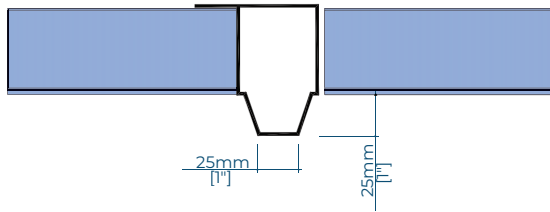

HORIZONTAL

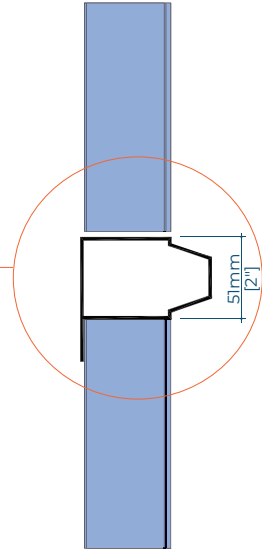

VERTICAL

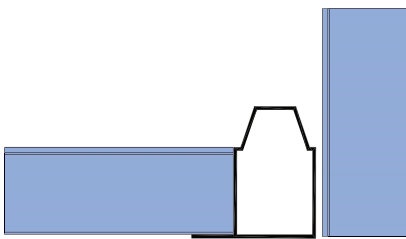

INNER CORNER

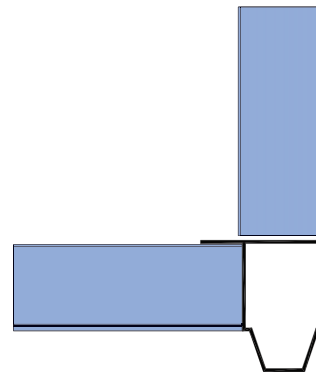

OUTER CORNER

# PANEL METAL ACCENT

## OPTION 10: FACE PROTRUDED (A10-P)

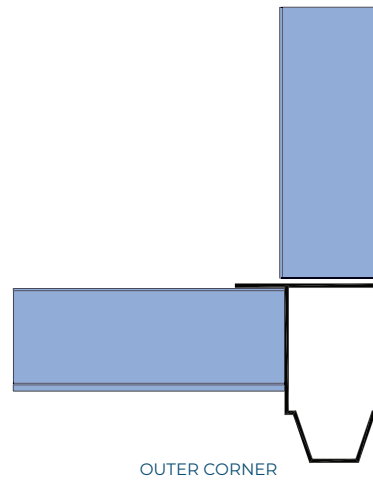
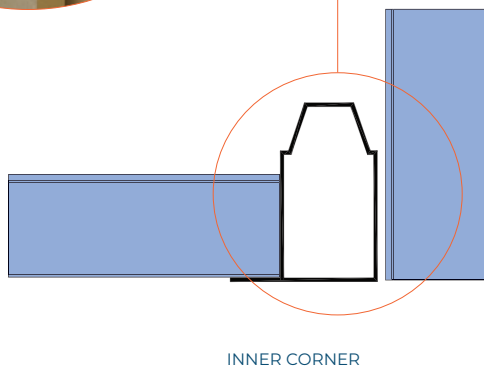
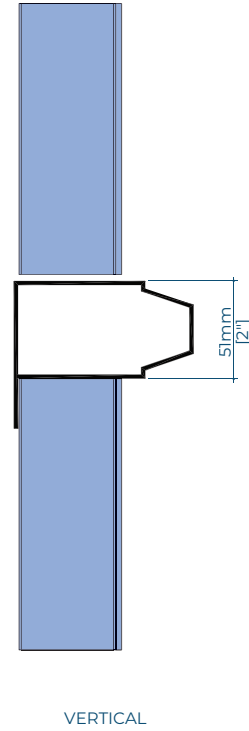
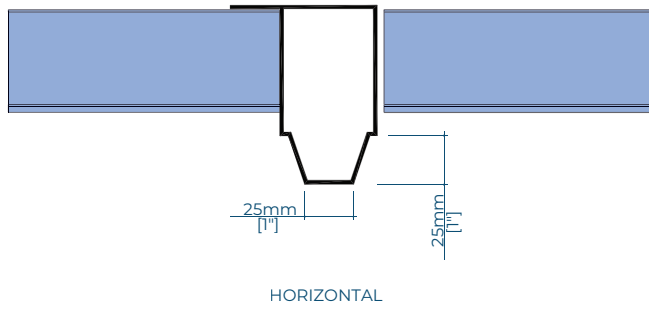

PANEL METAL ACCENT

OPTION 11: FACE ALIGNMENT (A1)

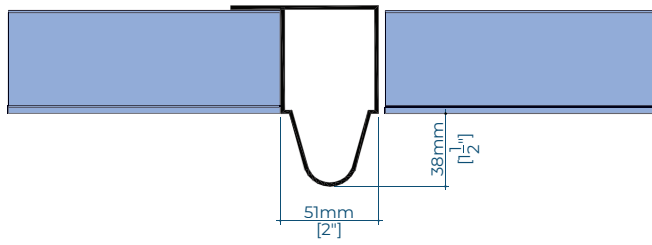

HORIZONTAL

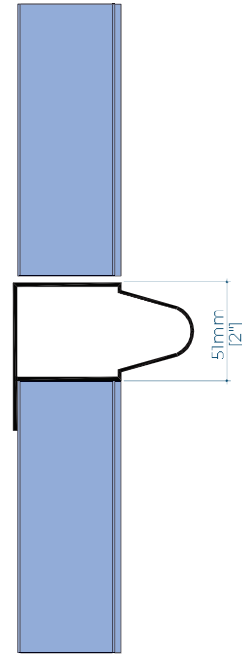

VERTICAL

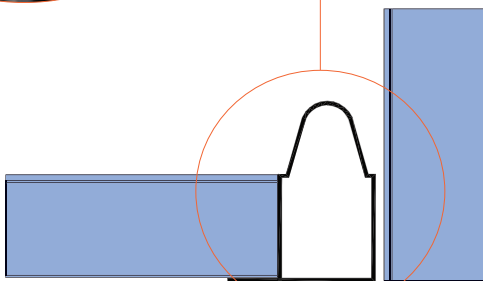
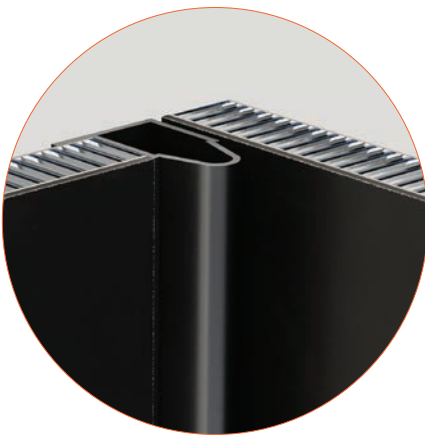

INNER CORNER

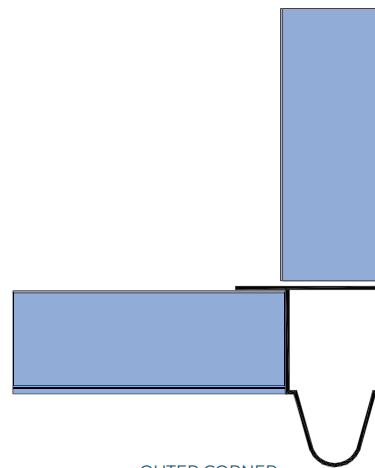

OUTER CORNER

# PANEL METAL ACCENT

## OPTION 11: FACE PROTRUDED (A11-P)

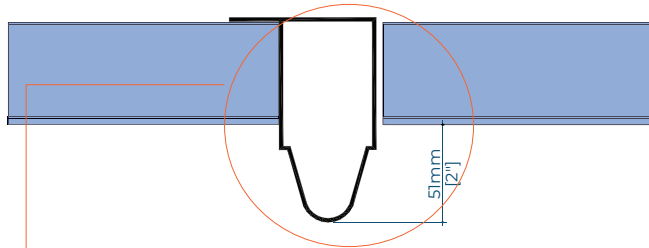

HORIZONTAL

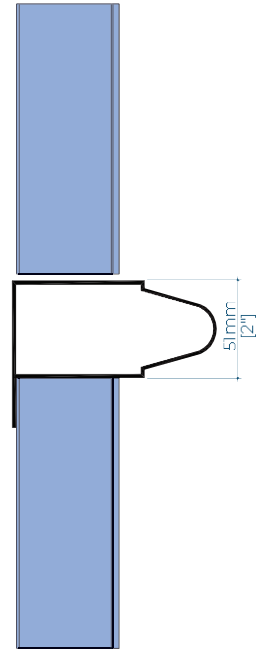

VERTICAL

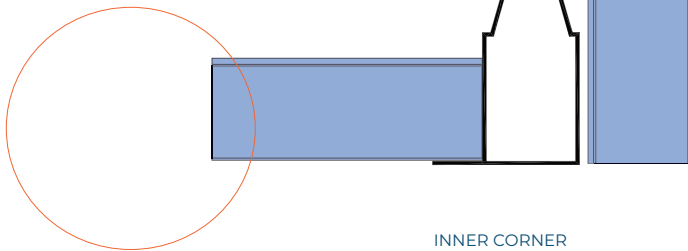

INNER CORNER

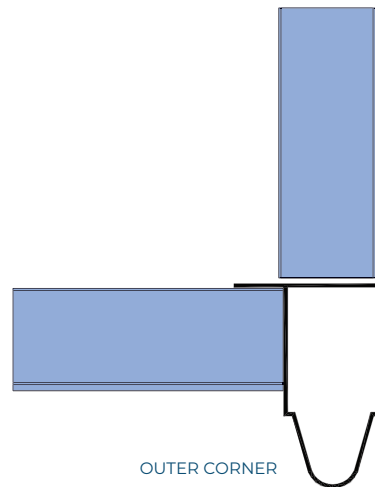

OUTER CORNER

# PANEL METAL ACCENT

## OPTION 12: FACE ALIGNMENT (A12)

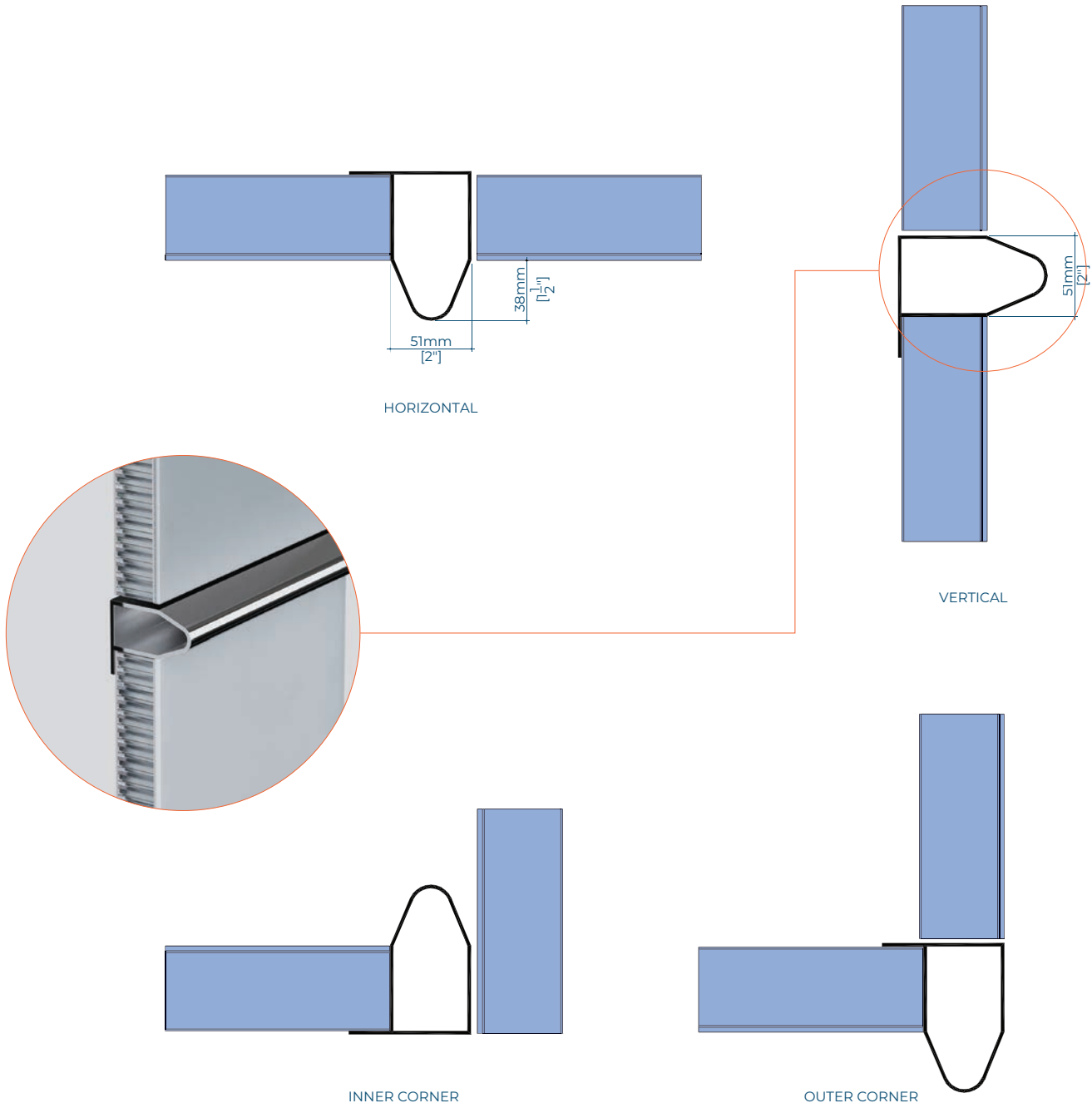

# PANEL METAL ACCENT

## OPTION 12: FACE PROTRUDED (A12-P)

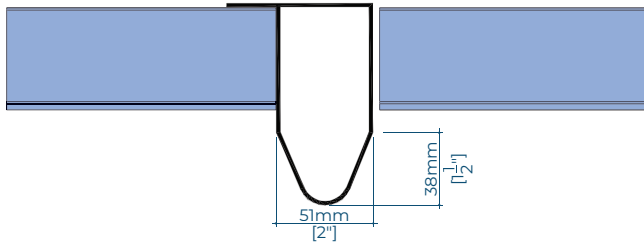

HORIZONTAL

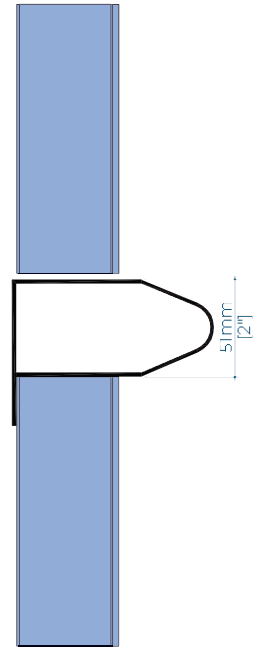

VERTICAL

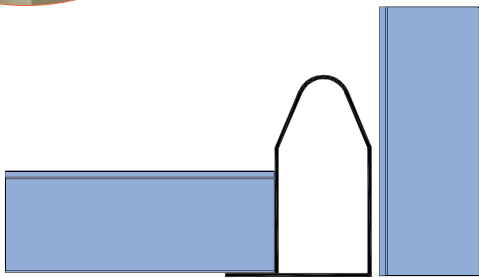
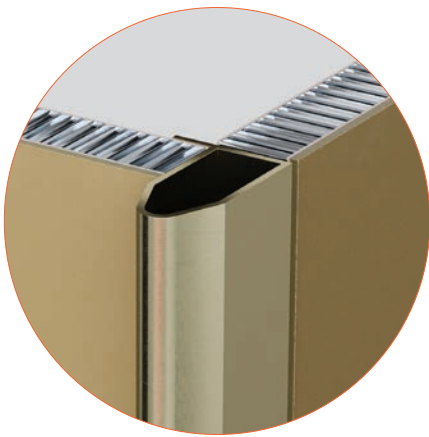

INNER CORNER

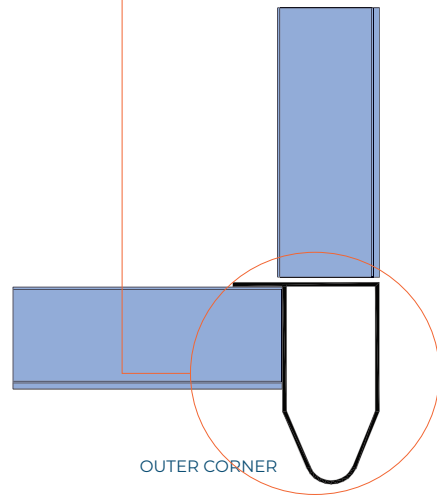

OUTER CORNER

# PANEL METAL ACCENT

## OPTION 13: FACE ALIGNMENT (A13)

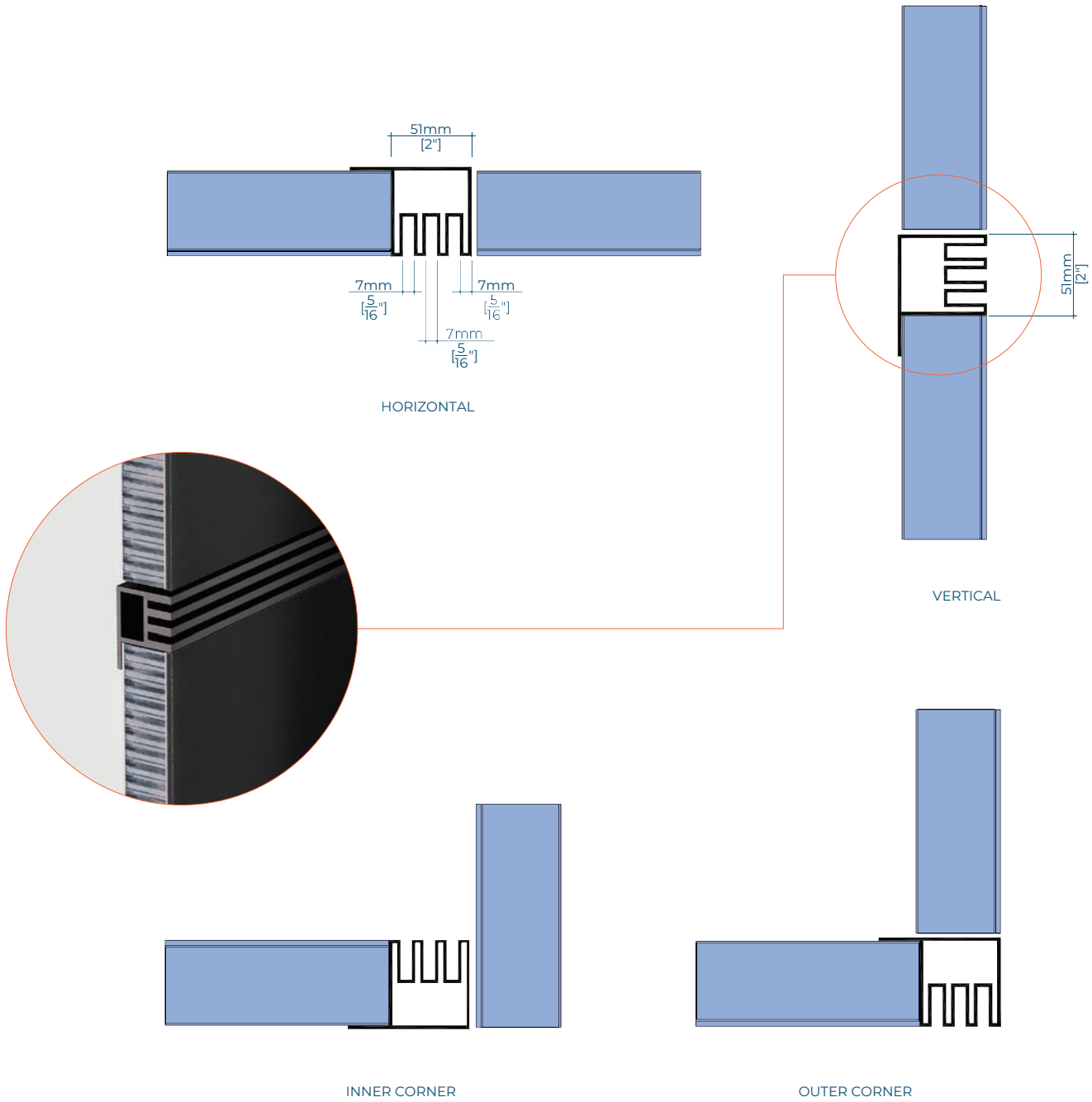



# PANEL METAL ACCENT

## OPTION 13: FACE PROTRUDED (A13-P)

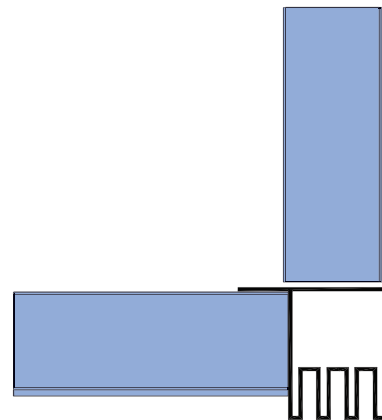
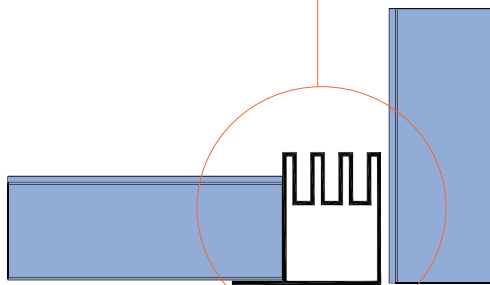
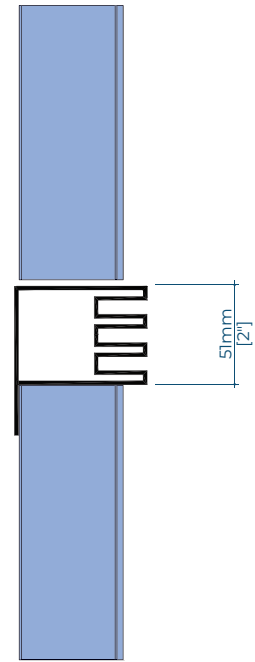
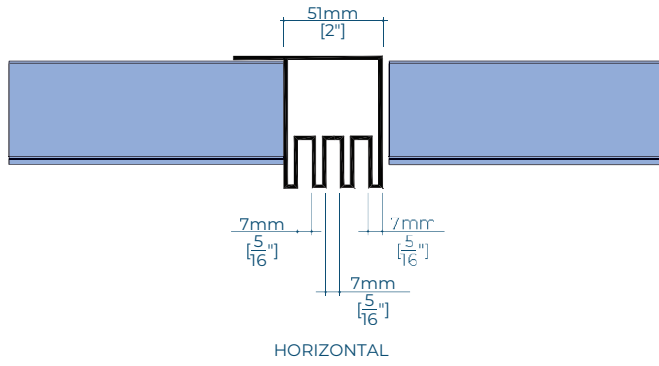

## PANEL METAL ACCENT COMBINATIONS

### OPTION 1: FACE ALIGNMENT (A1-A1)

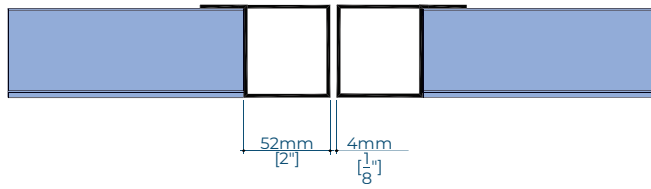

HORIZONTAL

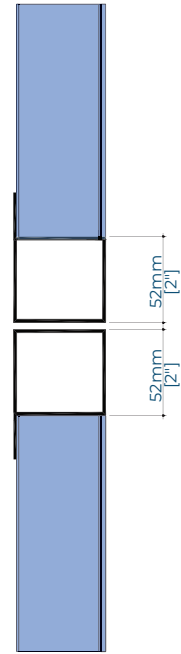

VERTICAL

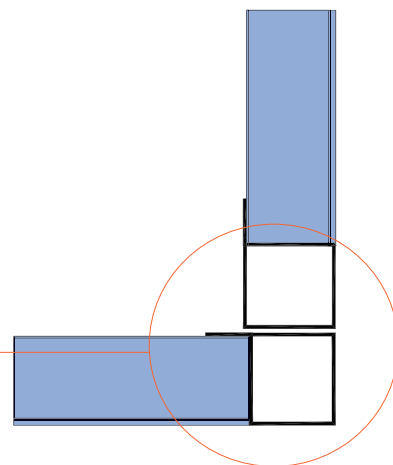

OUTER CORNER

## PANEL METAL ACCENT COMBINATIONS

OPTION 1: FACE PROTRUDED (A1P-A1P)

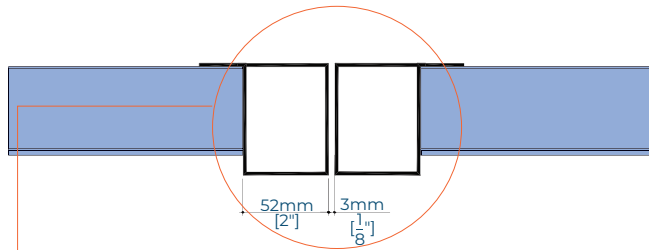

HORIZONTAL

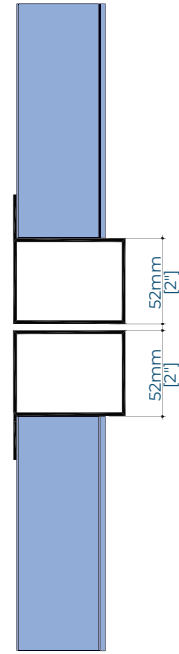
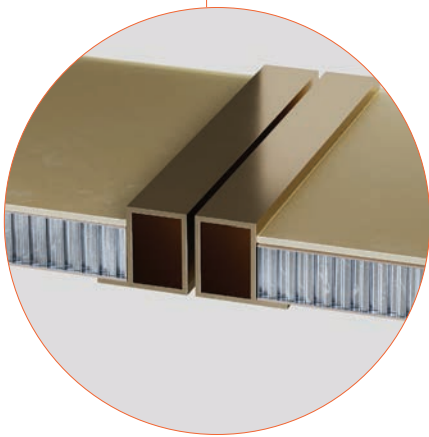

VERTICAL

# PANEL METAL ACCENT COMBINATIONS

## OPTION 2: FACE ALIGNMENT (A2-A2)

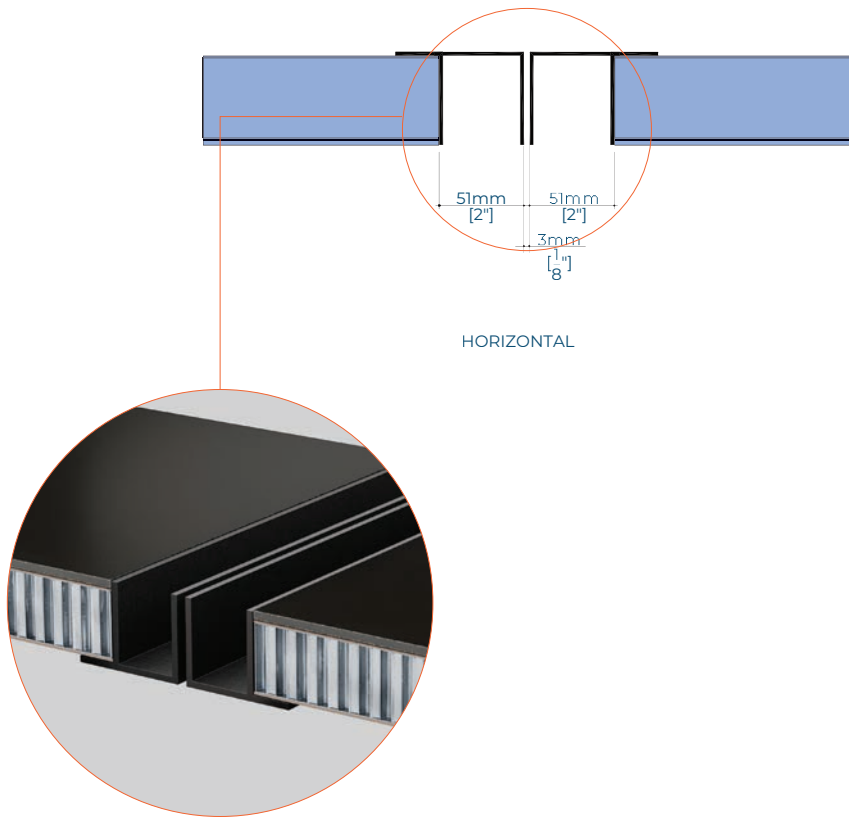

HORIZONTAL

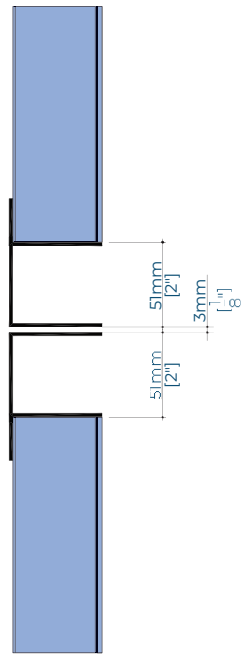

VERTICAL

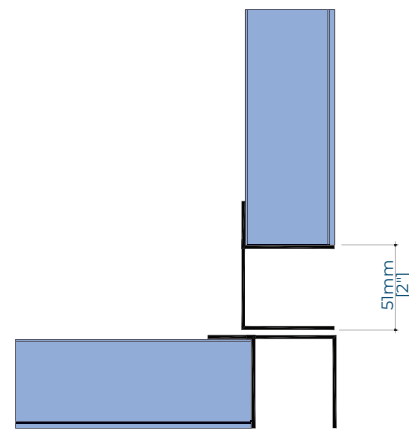

OUTER CORNER

# PANEL METAL ACCENT COMBINATIONS

OPTION 2: FACE PROTRUDED (A2P-A2P)

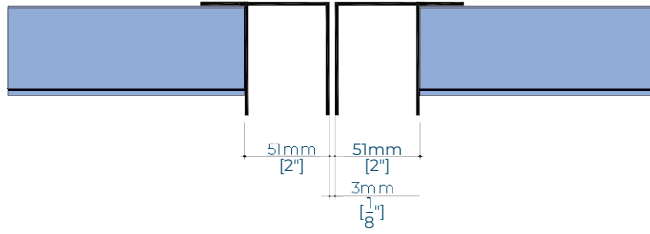

HORIZONTAL

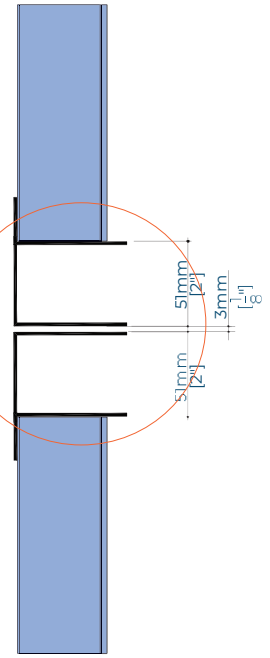

VERTICAL

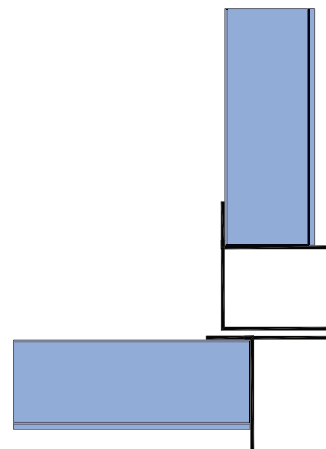

OUTER CORNER

## PANEL METAL ACCENT COMBINATIONS

### OPTION 3: FACE ALIGNMENT (A3-A3)

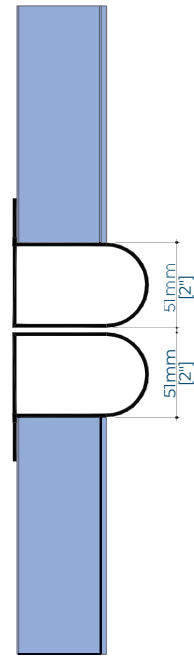
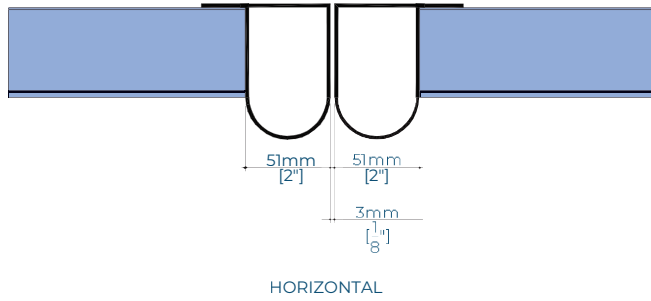

### OPTION 3: FACE PROTRUDED (A3P-A3P)

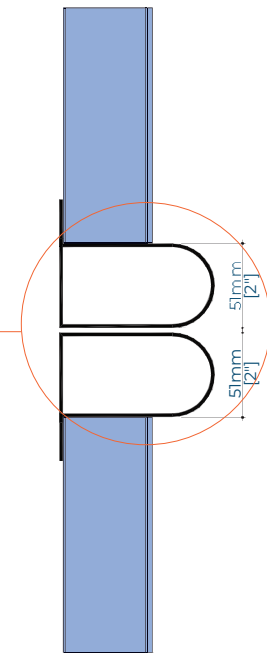
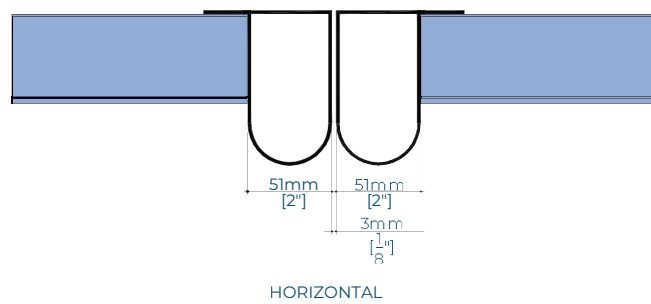

## PANEL METAL ACCENT COMBINATIONS

### OPTION 4 : FACE ALIGNMENT (A4-A4)

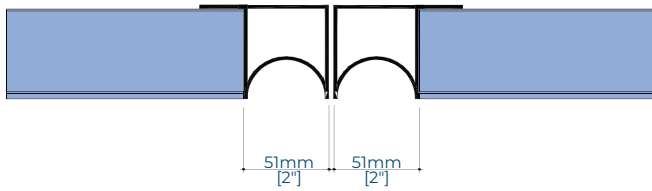

HORIZONTAL

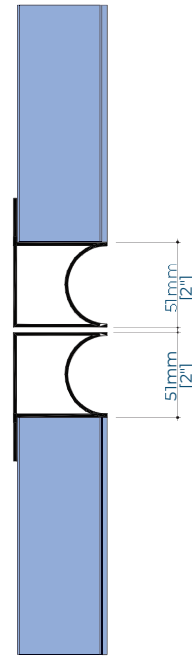

VERTICAL

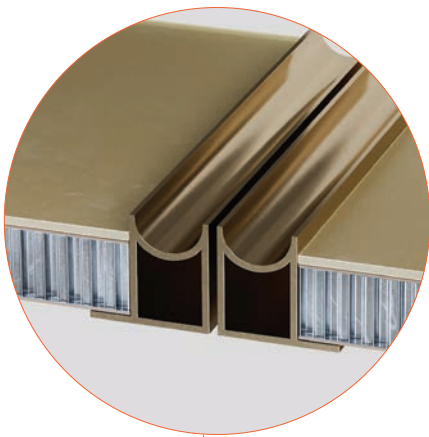

### OPTION 4: FACE PROTRUDED (A4P-A4P)

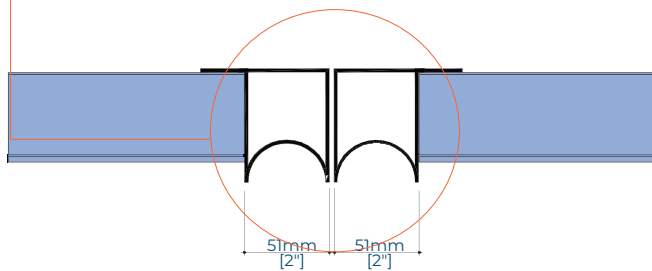

HORIZONTAL

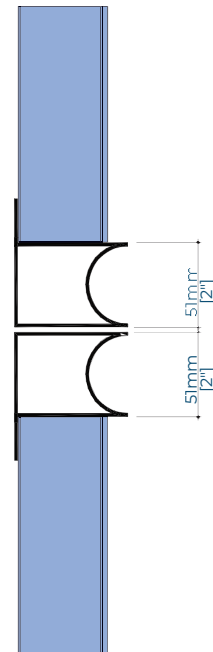

VERTICAL

# PANEL METAL ACCENT COMBINATIONS

## OPTION 5: FACE ALIGNMENT (A5-A5)

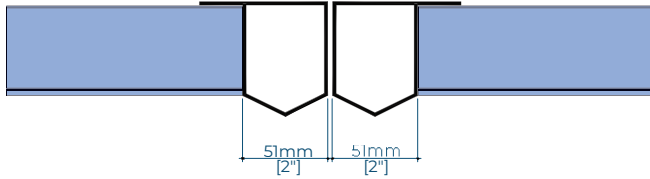

HORIZONTAL

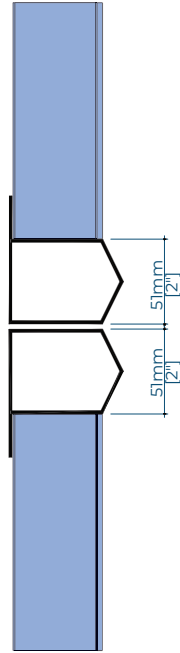

VERTICAL

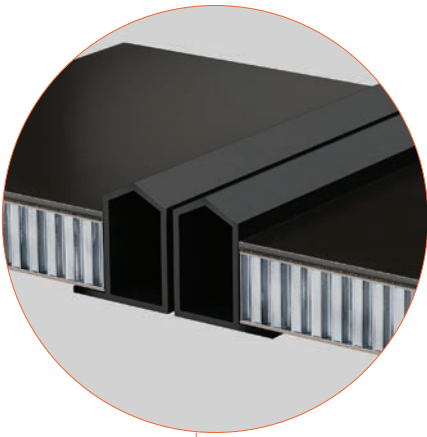

## OPTION 5: FACE PROTRUDED (A5P-A5P)

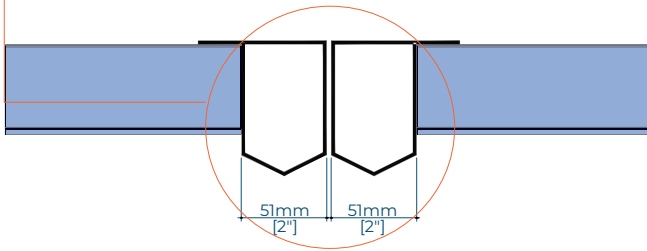

HORIZONTAL

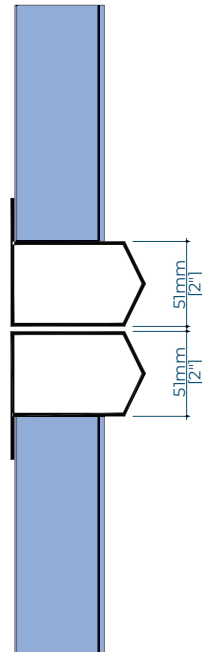

VERTICAL



# PANEL METAL ACCENT COMBINATIONS

## OPTION 6: FACE ALIGNMENT (A6-A6)

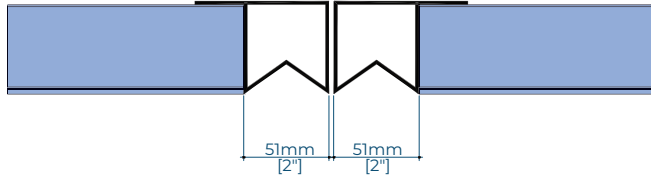

HORIZONTAL

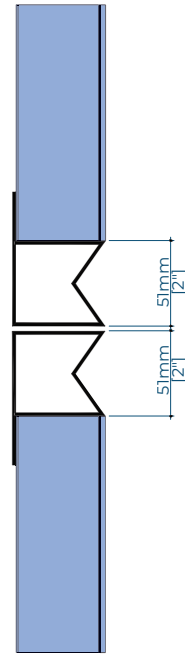

VERTICAL



## OPTION 6: FACE PROTRUDED (A6P-A6P)

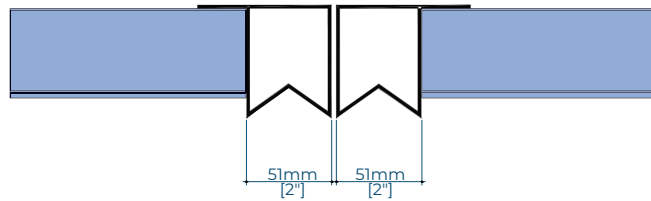

HORIZONTAL

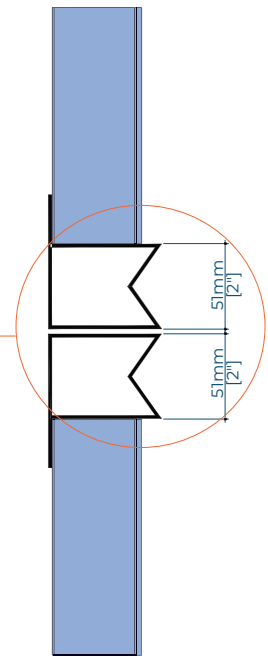

VERTICAL

# PANEL METAL ACCENT COMBINATIONS

## OPTION 7: FACE ALIGNMENT (A7-A7)

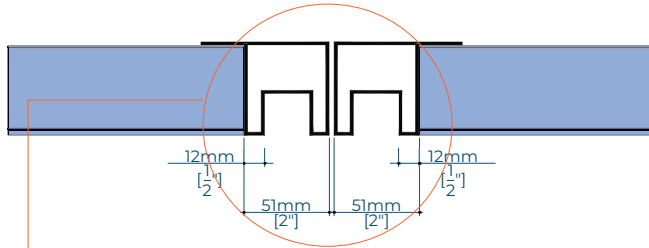

HORIZONTAL

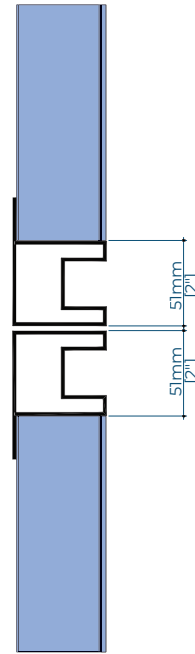

VERTICAL

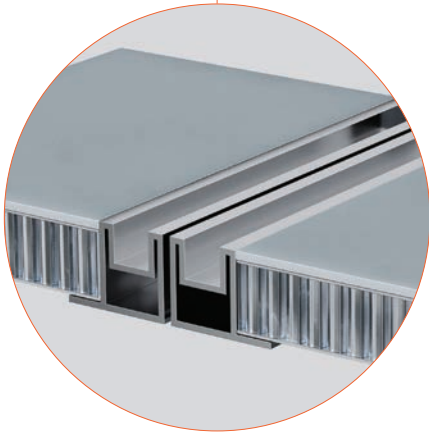

## OPTION 7: FACE PROTRUDED (A7P-A7P)

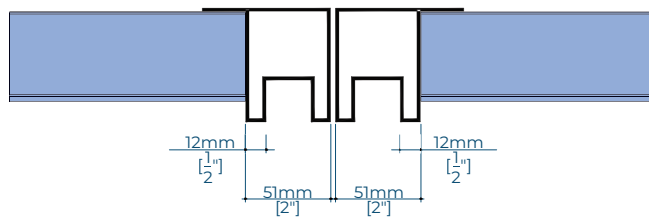

HORIZONTAL

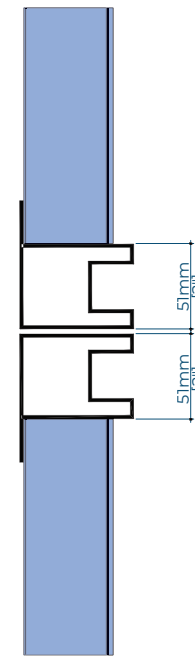

VERTICAL

# PANEL METAL ACCENT COMBINATIONS

## OPTION 8: FACE ALIGNMENT (A8-A8)

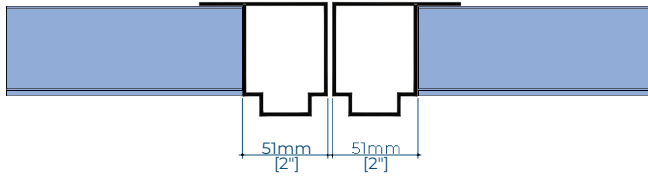

HORIZONTAL



VERTICAL



## OPTION 8: FACE PROTRUDED (A8P-A8P)

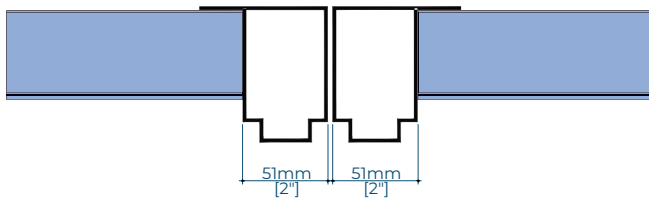

HORIZONTAL

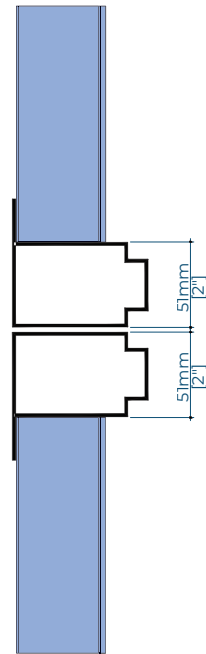

VERTICAL

# PANEL METAL ACCENT COMBINATIONS

OPTION 9: FACE ALIGNMENT (A9-A9)

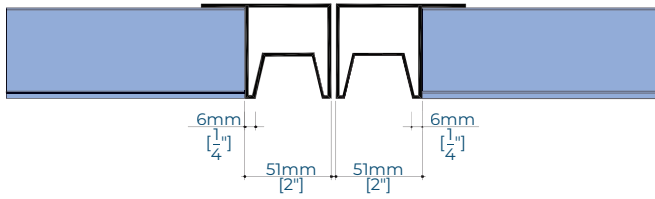

HORIZONTAL

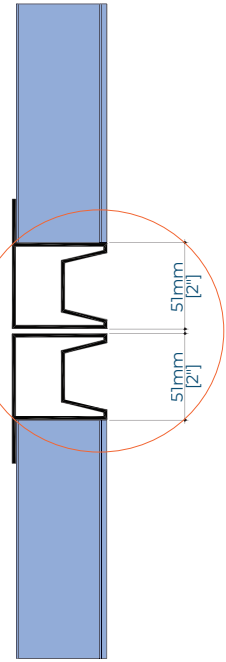

VERTICAL



OPTION 9: FACE PROTRUDED (A9P-A9P)

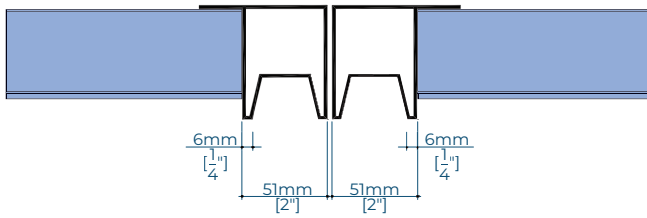

HORIZONTAL

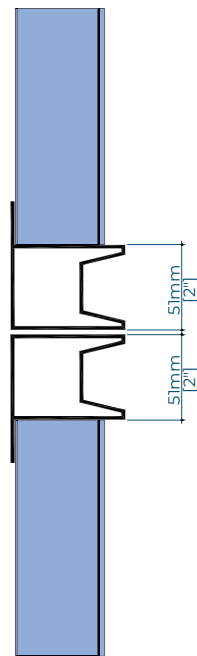

VERTICAL

# PANEL METAL ACCENT COMBINATIONS

## OPTION 10: FACE ALIGNMENT (A10-A10)

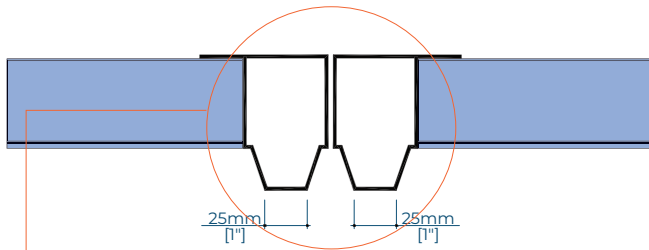

HORIZONTAL

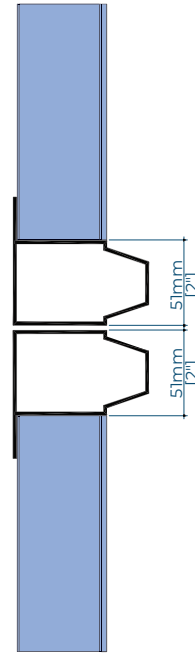

VERTICAL

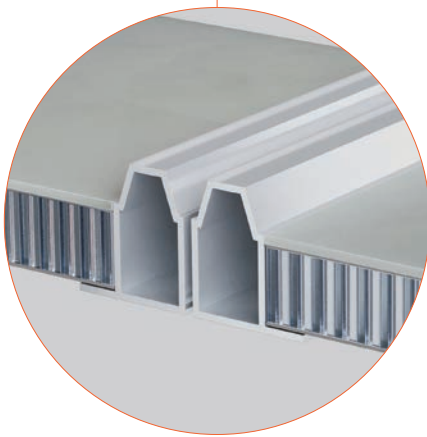

## OPTION 10: FACE PROTRUDED (A10P-A10P)

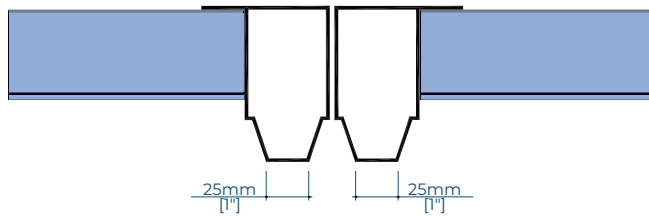

HORIZONTAL

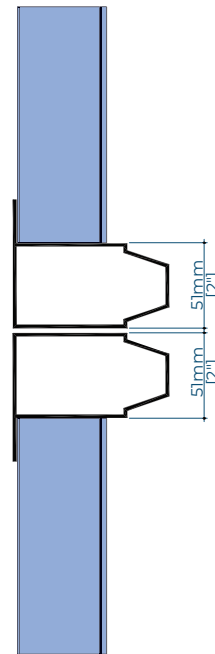

VERTICAL

# PANEL METAL ACCENT COMBINATIONS

OPTION 11: FACE ALIGNMENT (A11-A11)

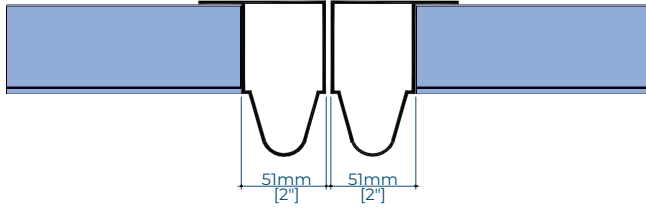

HORIZONTAL

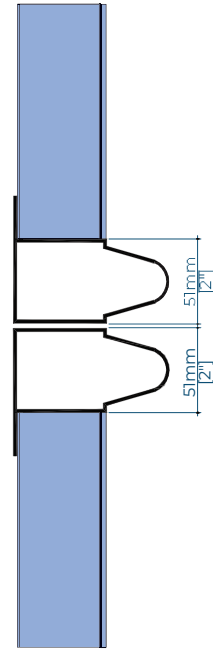

VERTICAL

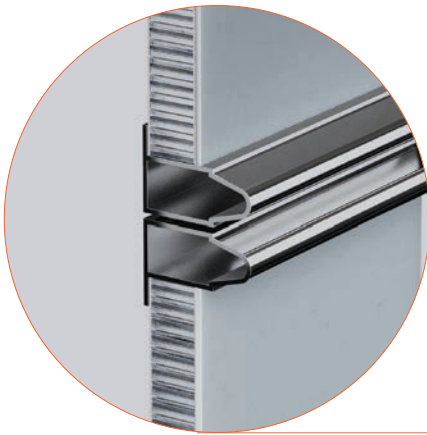

OPTION 11: FACE PROTRUDED (A11P-A11P)

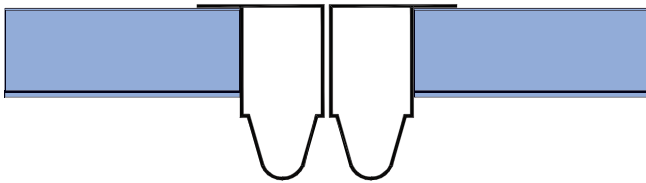

HORIZONTAL

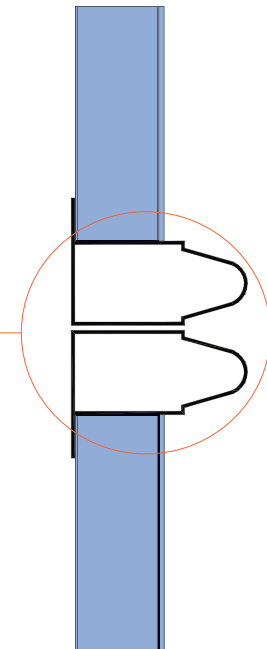

VERTICAL

## PANEL METAL ACCENT COMBINATIONS

### OPTION 12: FACE ALIGNMENT (A12-A12)

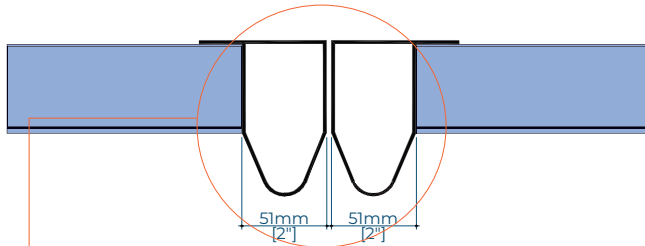

HORIZONTAL

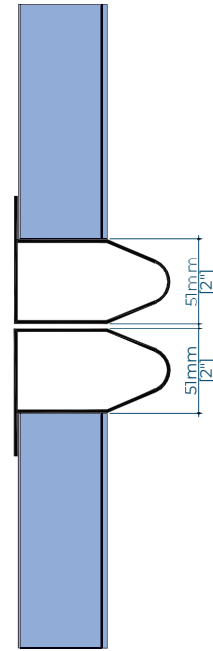

VERTICAL

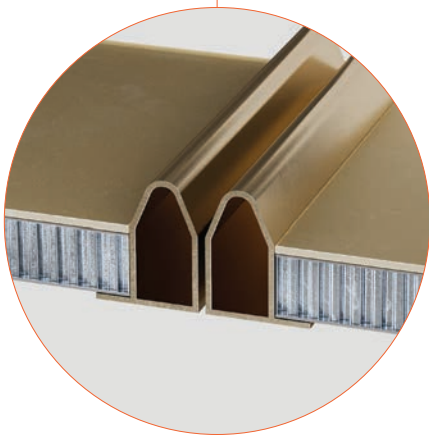

### OPTION 12: FACE PROTRUDED (A12P-A12P)

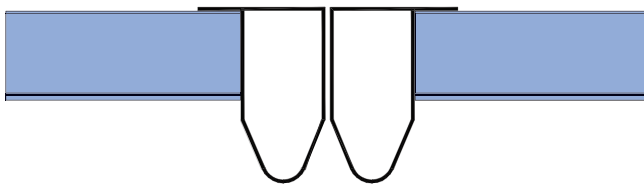

HORIZONTAL

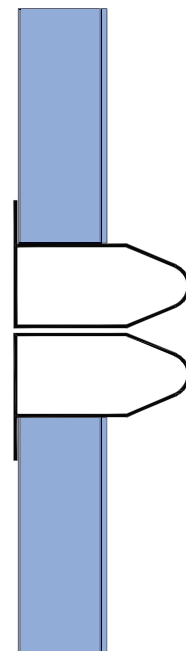

VERTICAL

# PANEL METAL ACCENT COMBINATIONS

OPTION 13: FACE ALIGNMENT (A13-A13)

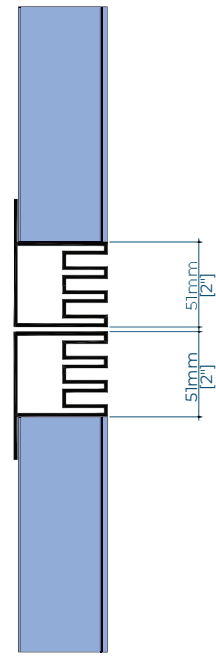
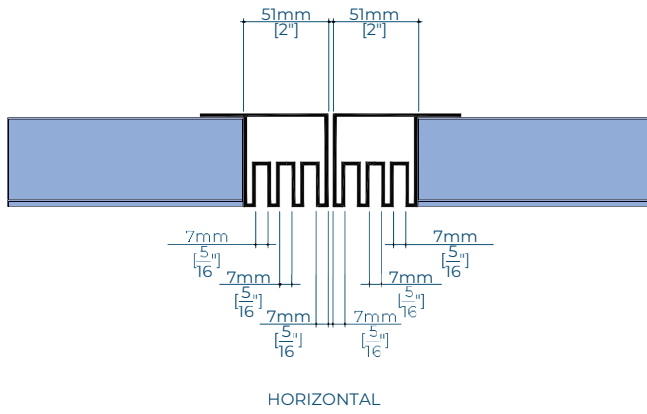

OPTION 13: FACE PROTRUDED (A13P-A13P)

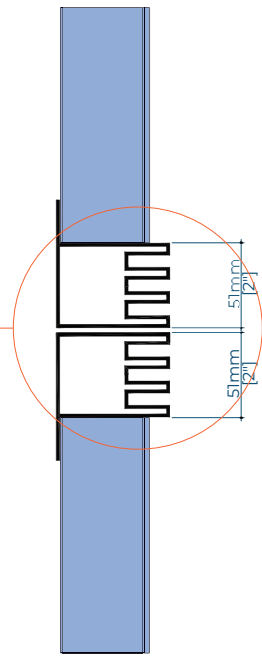
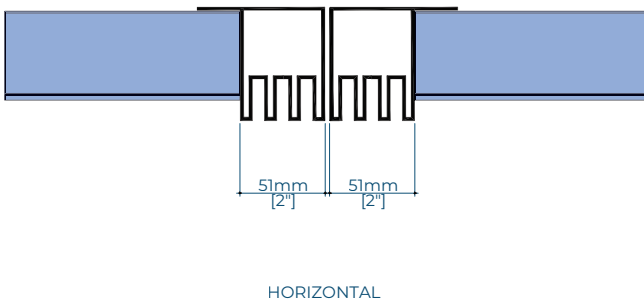



# PANEL METAL ACCENT COMBINATIONS

OPTION 14: FACE ALIGNMENT (A1-A1P)

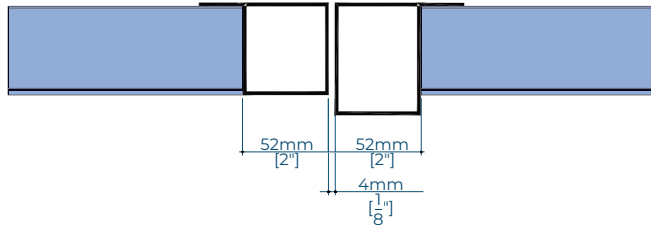

HORIZONTAL

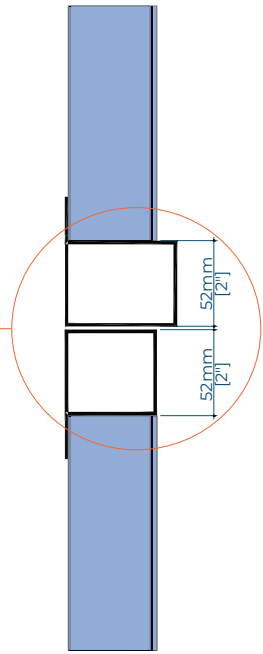

VERTICAL

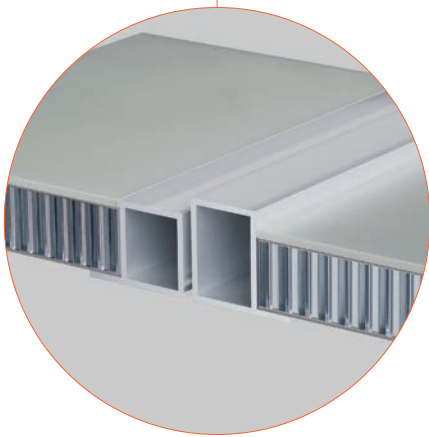

OPTION 14: FACE PROTRUDED (A5-A5P)

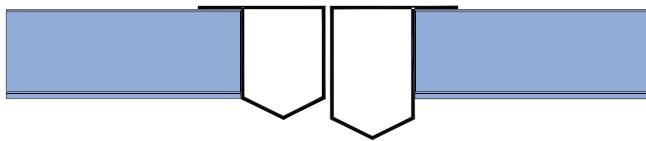

HORIZONTAL

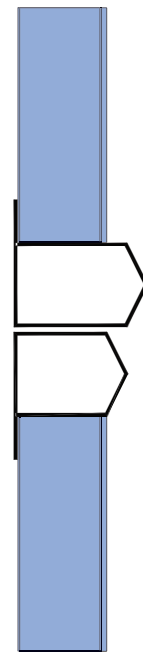

VERTICAL

## PANEL METAL ACCENT COMBINATIONS

OPTION 15: FACE ALIGNMENT (A3-A3P)

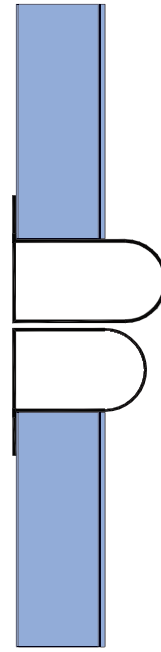
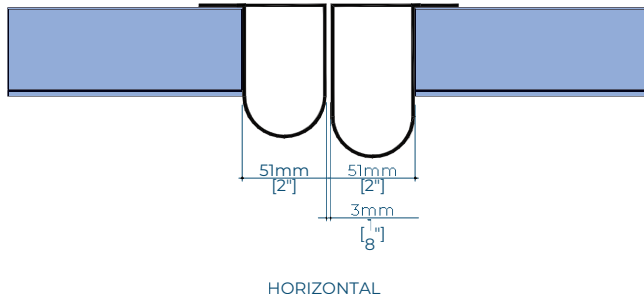

VERTICAL

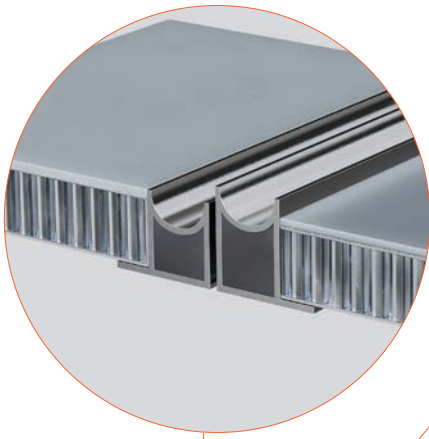

OPTION 15: FACE PROTRUDED (A4-A4P)

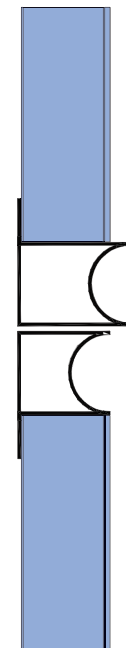
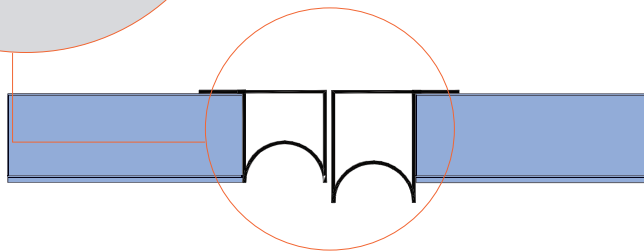

VERTICAL

## PANEL METAL ACCENT COMBINATIONS

### OPTION 16: FACE ALIGNMENT (A7-A7P)

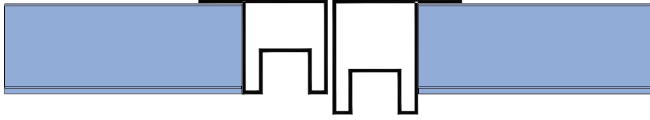

HORIZONTAL

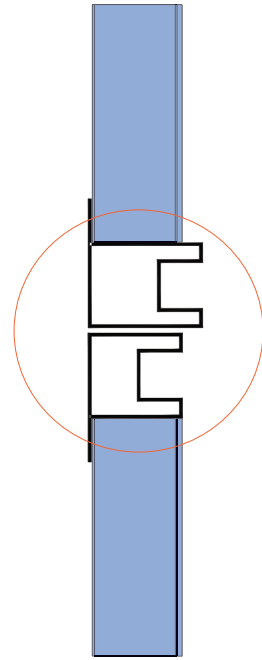

VERTICAL



### OPTION 16: FACE PROTRUDED (A9-A9P)

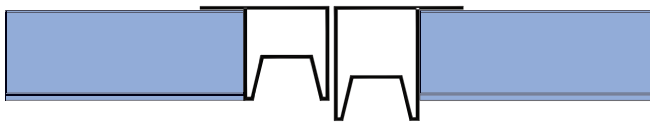

HORIZONTAL

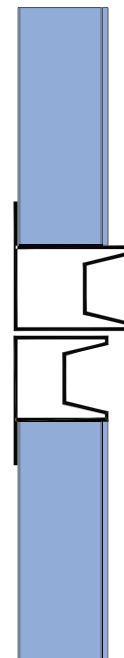

VERTICAL

## PANEL METAL ACCENT COMBINATIONS

OPTION 17: FACE ALIGNMENT (A8-A8P)

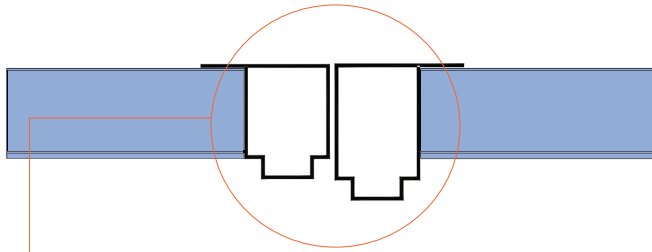

HORIZONTAL

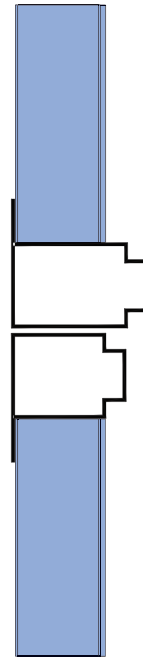

VERTICAL

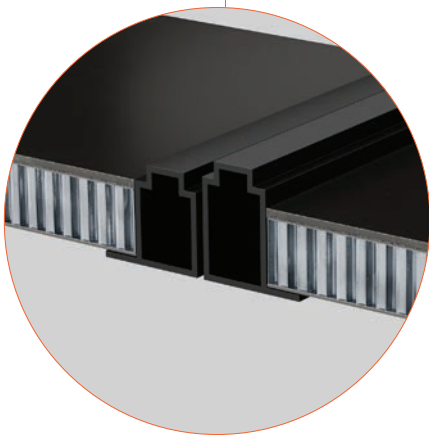

OPTION 17: FACE PROTRUDED (A10-A10P)

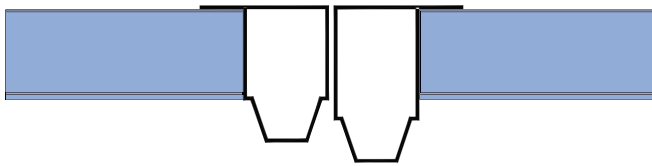

HORIZONTAL

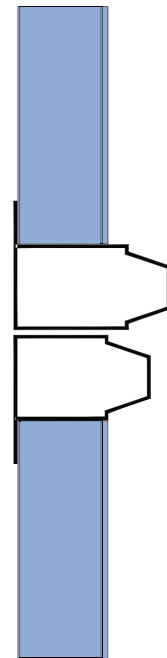

VERTICAL

## PANEL METAL ACCENT COMBINATIONS

OPTION 18: FACE ALIGNMENT (A11-A11P)

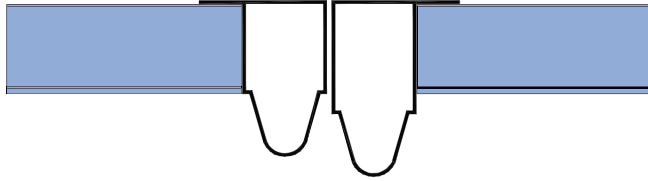

HORIZONTAL

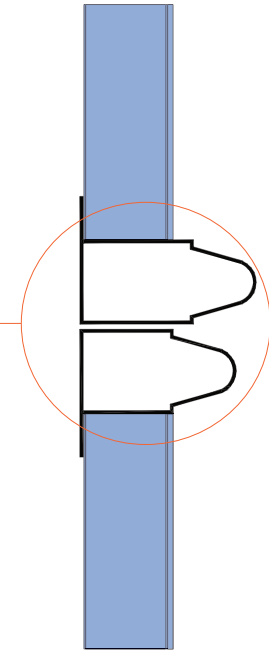

VERTICAL



OPTION 18: FACE PROTRUDED (A13-A13P)



HORIZONTAL

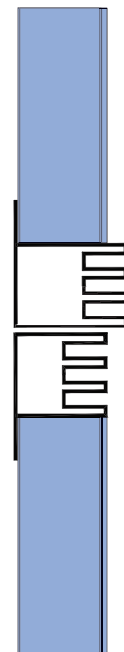

VERTICAL

## PANEL METAL ACCENT COMBINATIONS

### OPTION 19: FACE ALIGNMENT (A12-A12P)

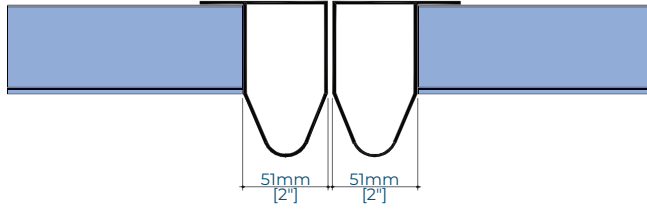

HORIZONTAL

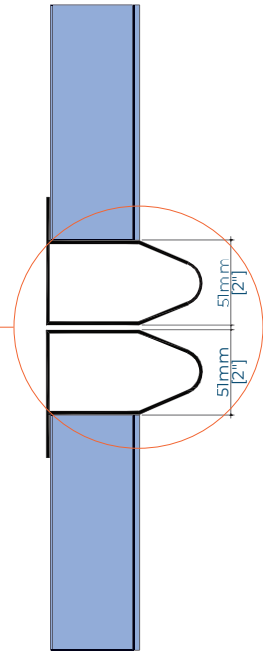

VERTICAL

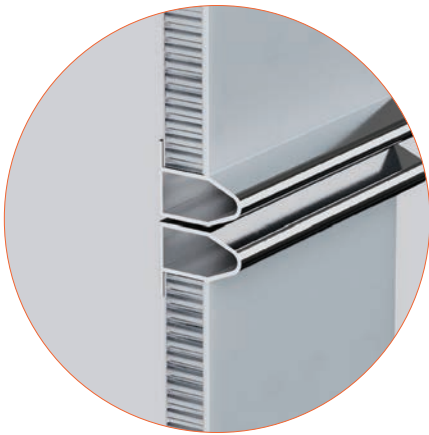

# PANEL METAL ACCENT COMBINATIONS

## OPTION 20: FACE ALIGNMENT (A1-A2)



HORIZONTAL



VERTICAL

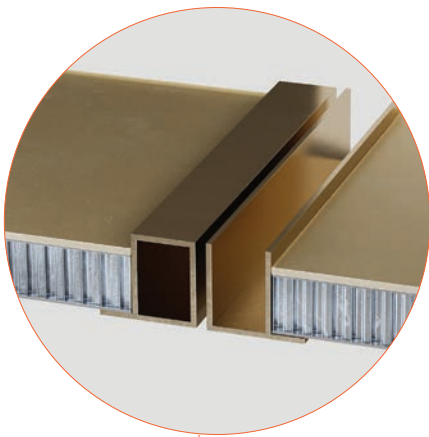

## OPTION 20: FACE PROTRUDED (A1P-A2P)

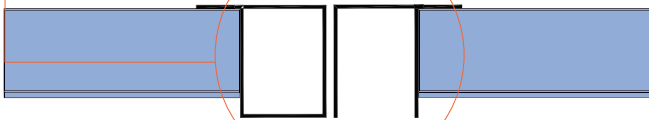

HORIZONTAL

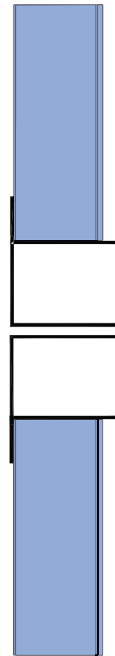

VERTICAL

## PANEL METAL ACCENT COMBINATIONS

### OPTION 21: FACE ALIGNMENT (A3-A4)



HORIZONTAL

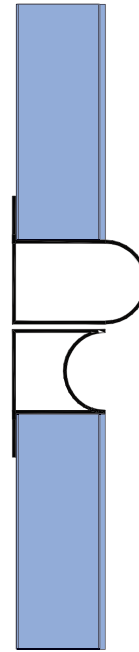

VERTICAL

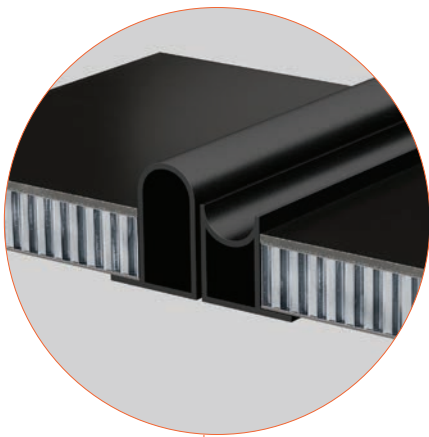

### OPTION 21: FACE PROTRUDED (A3P-A4P)

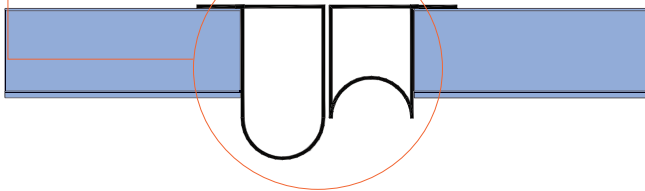

HORIZONTAL

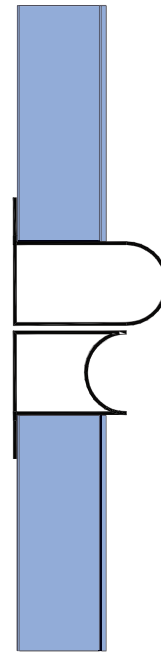

VERTICAL



# PANEL METAL ACCENT COMBINATIONS

## OPTION 22: FACE ALIGNMENT (A5-A6)

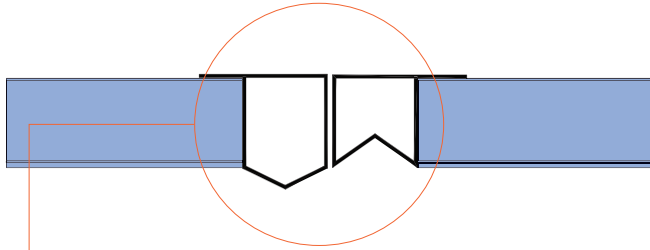

HORIZONTAL

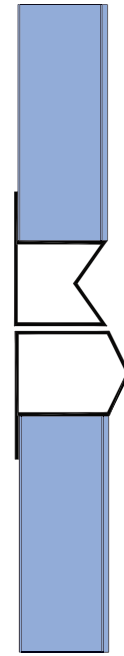

VERTICAL

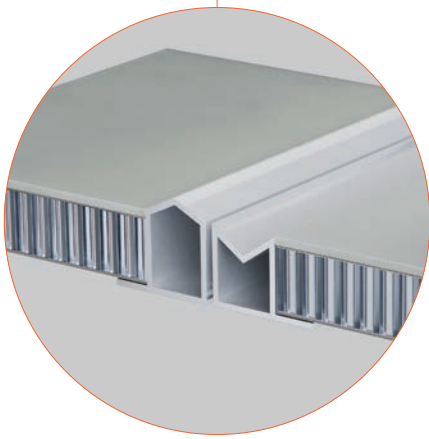

## OPTION 22: FACE PROTRUDED (A5P-A6P)

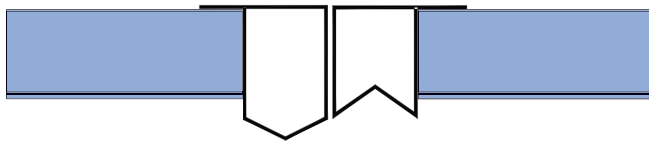

HORIZONTAL

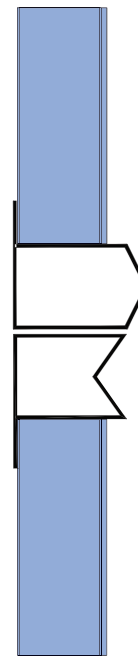

VERTICAL

## PANEL METAL ACCENT COMBINATIONS

OPTION 23: FACE ALIGNMENT (A7-A8)

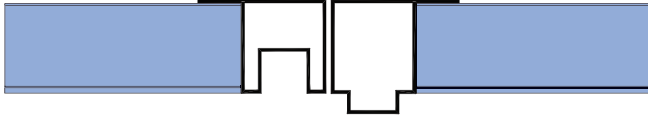

HORIZONTAL

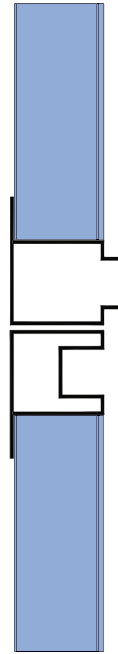

VERTICAL

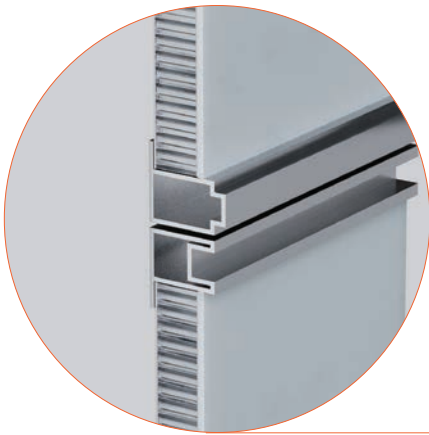

OPTION 23: FACE PROTRUDED (A7P-A8P)

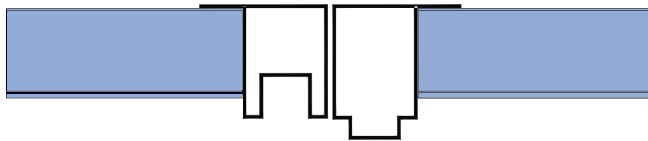

HORIZONTAL

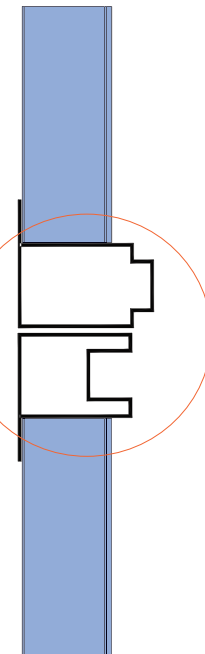

VERTICAL

## PANEL METAL ACCENT COMBINATIONS

OPTION 24: FACE ALIGNMENT (A9-A10)

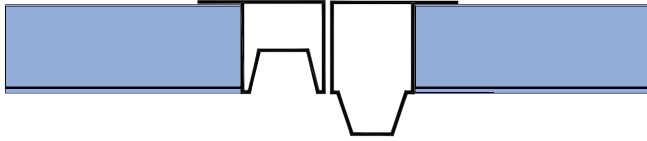

HORIZONTAL

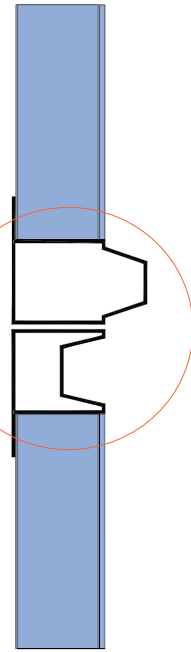

VERTICAL

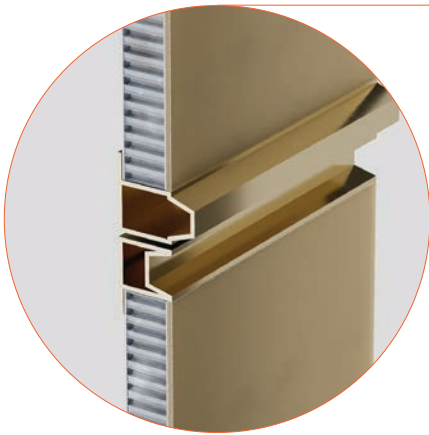

OPTION 24: FACE PROTRUDED (A9P-A10P)

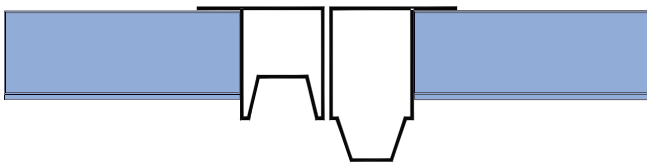

HORIZONTAL

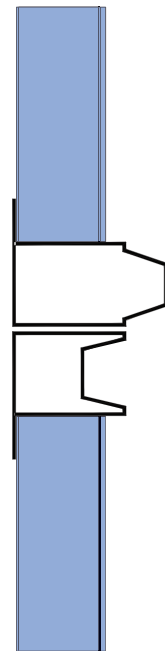

VERTICAL



LEARN MORE:

[MITREX.COM](http://MITREX.COM) | [CLADIFY.COM](http://CLADIFY.COM)

 [info@mitrex.com](mailto:info@mitrex.com)  
[info@cladify.com](mailto:info@cladify.com)

 +1-855-254-0214 (Toll Free)

Headquarters:

 41 Racine Rd., Toronto,  
ON M9W 2Z4, Canada

 +1 (416) 497 7120

USA:

 10880 Wilshire Blvd Suite 1101,  
Los Angeles, CA 90024, USA

 +1 (323) 301 7978

 1 Rockefeller Plaza Fl 11,  
New York, NY 10020, USA

 +1 (646) 583 4486