

2024

DOCRILUC



DOCRILUC

Catálogo General - General Catalogue - Catalogue Général

DOCRILUC

Carretera Córdoba-Málaga, km. 75,800
14900 LUCENA (Córdoba) ESPAÑA
Telf.: 0034 957 510 126 · Fax: 0034 957 510 682
info@docriluc.es
www.docriluc.es

2024
Catálogo General
General Catalogue
Catalogue Général



Presentamos en este catalogo 2024 nuestra continua evolución en la aplicación de las nuevas oportunidades tecnológicas, que nos hace crear con mayor calidad, y con una eficiencia energética que nos permite un ahorro en algunos modelos sin incorporar ningún elemento ni sustancia que ataque al medio ambiente o no sea reciclable.

Hemos incorporado nuevos productos que complementan nuestra gama y hemos evolucionado y actualizado la mayoría de los modelos existentes.

Como complemento al presente catálogo, podrá descargarlo así como las fichas técnicas de nuestros productos y toda la información a través de nuestra web www.docriluc.es y en las redes sociales.

Esperamos poder seguir contando con su confianza.



We present in this 2024 catalog we our continuous evolution in the application of new technological opportunities, that makes us create higher quality, and with an energy efficiency that allows us to save on some models not being without incorporating any element or substance that attacks the environment or recyclable.

We have introduced products that complement our range and we have evolved and updated most existing.

As to this catalog, we you can download as well as technical files of our products and all information through our website www.docriluc.es and in social networks.



2024 présentés dans ce catalogue notre évolution continue dans l'application des nouvelles opportunités technologiques, qui nous fait créons une plus grande efficacité de la qualité et de l'énergie qui nous permet d'économiser sur certains modèles sans incorporer quelconque élément ou substance qui attaque l'environnement ou est non recyclable.

Nous avons ajouté de nouveaux produits pour compléter notre gamme et nous avons évolué et mis à jour la plupart des modèles existants.

En complément de ce catalogue, vous pouvez télécharger ainsi que les détails de nos produits et toutes les informations par le biais de nos www.docriluc.es web et les réseaux sociaux. Nous nous réjouissons de votre confiance continue.



Docriluc es una empresa española especializada en el diseño y fabricación de frío comercial e industrial para hostelería y alimentación. Dispone de ocho cadenas flexibles de producción, dotadas de las técnicas más avanzadas, que nos permiten ofrecer una respuesta ágil y de calidad certificada, contrastada con la implantación de la ISO 9001:2015.

También está provista de un sistema de gestión medioambiental que optimiza los recursos naturales, gestionando los residuos y su reciclaje controlados por la ISO 14001:2015.

Actualmente dispone de tres centros de producción con una superficie total de 38000 m2 dedicados a la fabricación, y de otros 4000 m2 destinados a logística. Como muestra de respeto por el medio ambiente y apuesta por la eficiencia energética, se cuenta con una instalación solar que hace disminuir, más si cabe, la huella de carbono en los productos fabricados.



Docriluc is a new Spanish company specialized in the design and manufacturing of commercial and industrial cooling systems for hospitality and food refrigeration industry. We have eight flexible assembly lines of production, fitted of the most advanced technology, which allow us to offer an agile response and of certified quality, verified with the establishment of the ISO 9001:2015.

Also we are supplied with an environmental management system which optimizes the natural resources, managing the residues and their recycling controlled by the ISO 14001: 2015.

It currently has three production centers with a total area of 38,000 m2 dedicated to manufacturing, and another 4000 m2 for logistics.

As a sign of respect for the environment and commitment to energy efficiency, there is a solar installation that reduces, if possible, the carbon footprint in the manufactured products.

Docriluc est une entreprise espagnole spécialisée dans le design et la fabrication de réfrigération commerciale et industrielle pour l'alimentation et l'hospitalité.

Nous avons huit lignes de production flexibles, équipés avec les techniques les plus avancées qui nous permettent d'offrir une réponse rapide, la qualité éprouvée avec la mise en œuvre de la norme ISO 9001:2015.

Est également muni d'un système de gestion de l'environnement qui optimise les ressources naturelles, la gestion des déchets et le recyclage contrôlé par la norme ISO 14001:2015.

Il dispose actuellement de trois centres de production d'une superficie totale de 38 000 m2 dédiés à la fabrication, et de 4 000 m2 supplémentaires pour la logistique.

En signe de respect de l'environnement et d'engagement en faveur de l'efficacité énergétique, il existe une installation solaire qui réduit, si possible, l'empreinte carbone des produits fabriqués.

Nuestros laboratorios están aprobados para testar y certificar según las normativas que exigen los reglamentos y directivas globales vigentes, asegurando el perfecto rendimiento, funcionalidad, calidad y clasificación energética de los equipos fabricados por Docriluc.



Our laboratories are approved to test and certify according to the regulations required by current global regulations and directives, ensuring the perfect performance, functionality, quality and energy classification of the equipment manufactured by Docriluc

Nos laboratoires sont agréés pour tester et certifier selon les réglementations requises par les réglementations et directives mondiales en vigueur, garantissant les performances, la fonctionnalité, la qualité et la classification énergétique parfaites des équipements fabriqués par Docriluc.



Sala de control, dotada de 4 cuadros eléctricos de gestión, 4 PC'S y 6 monitores de operación y visualización.

Control room, equipped with 4 electrical management panels, 4 PC's and 6 operation and display monitors

Salle de contrôle, équipée de 4 panneaux de gestion électrique, 4 PC et 6 moniteurs d'opération et de visualisation.



4 Salas de ensayo climatizadas, con controles independientes de temperatura, humedad y velocidad de aire, capacidad para multiensayo.

4 air-conditioned test rooms, with independent controls for temperature, humidity and air speed, multi-test capacity.

4 salles d'essais climatisées, avec contrôles indépendants de la température, de l'humidité et de la vitesse de l'air, capacité multi-tests.



2 Salas de Ingeniería y desarrollo de productos.

2 Engineering and development rooms products.

2 salles d'ingénierie et de développement produits.



Sala de medición y calibración acústica.

Acoustic measurement and calibration room

Salle de mesure acoustique et d'étalonnage.

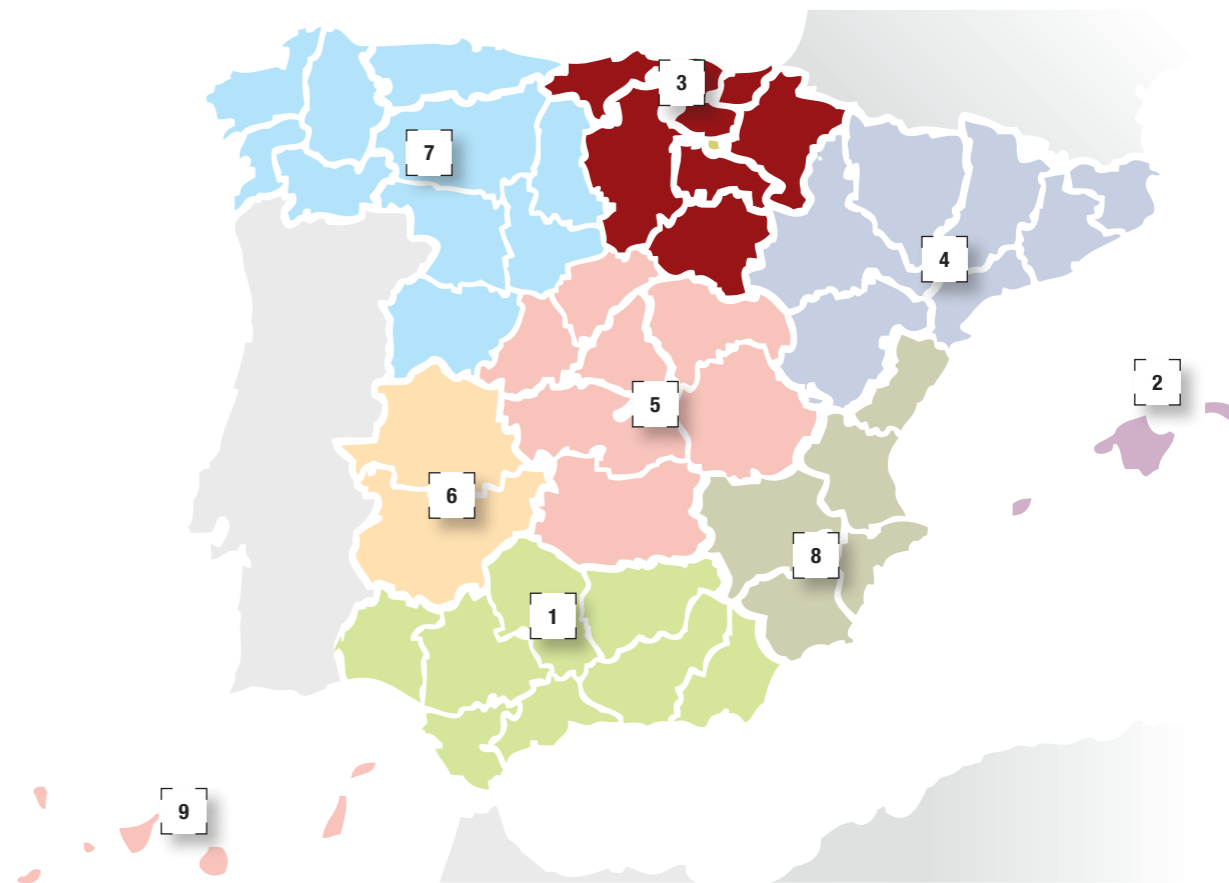
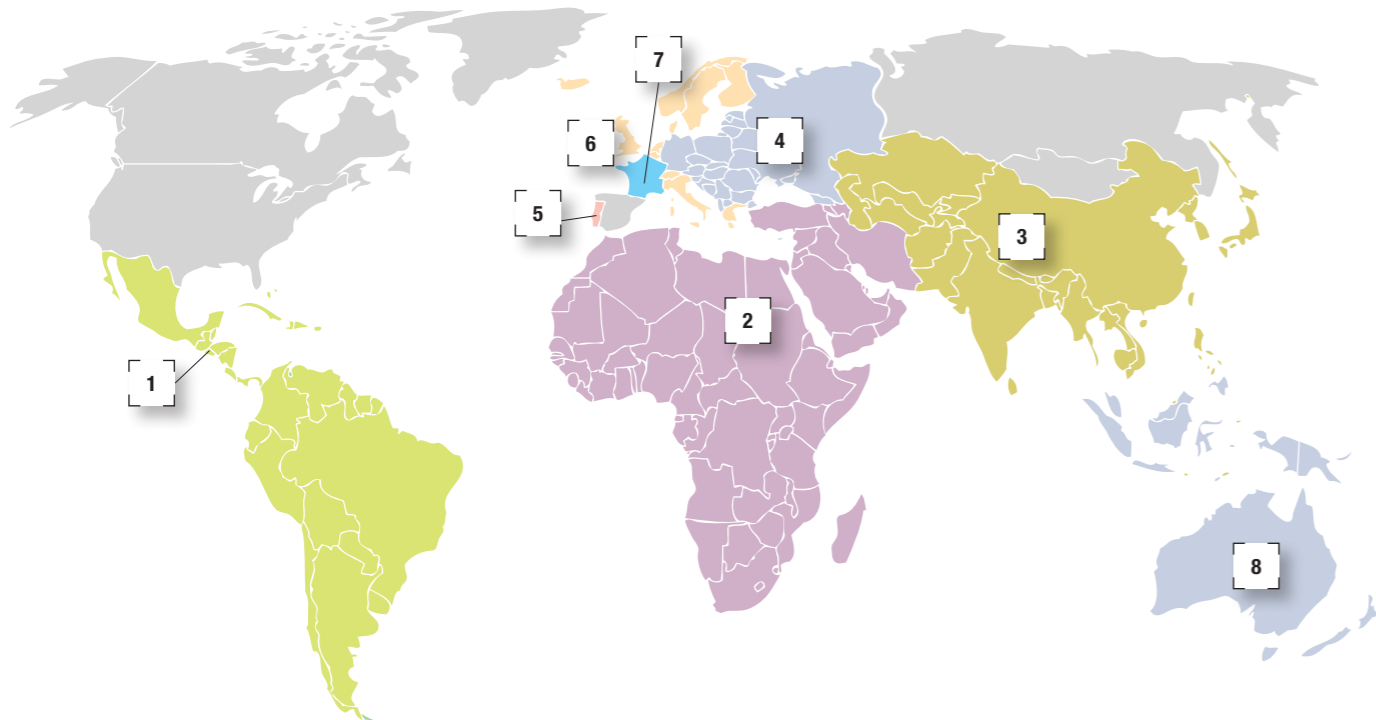

1 AMÉRICA LATINA - LATAM
Jhaminson Monrrois
M. +34 660 204 350
jmonrrois@docriluc.es

4 CENTRAL & EAST EUROPE
Carlos Cabello
M. + 34 600 471 601
ccabello@docriluc.es

7 FRANCIA
Codigel
Matthieu Sibille
Telf: 0033 1 80 83 77 00
matthieu-sibille@codigel.com

2 AFRICA & MIDDLE EAST
Francisco Córdoba
M. +34 608 802 718
fcordova@docriluc.es

5 PORTUGAL
Carlos Cabello
M. + 34 600 471 601
ccabello@docriluc.es

8 ASIA PACIFIC
Francisco Córdoba
M. +34 608 802 718
fcordova@docriluc.es

3 SOUTH EAST ASIA
Carlos Cabello
M. + 34 600 471 601
ccabello@docriluc.es

6 UK & IRELAND
Francisco Córdoba
M. +34 608 802 718
fcordova@docriluc.es

9 MEDITERRANEAN REGION
Carlos Cabello
M. + 34 600 471 601
ccabello@docriluc.es

1 ANDALUCÍA
Delegación Fábrica
Alberto González
Tel. 618 012 776
agonzalez@docriluc.es

4 CATALUÑA Y ARAGÓN
Cristina Carreira Casas
Tel. móvil 687 588 134
Fax. 937 906 763
criscarreira@hotmail.com

7 CASTILLA-LEÓN, ASTURIAS Y GALICIA
Jose Manuel Fernández Fernández
Tel. movil 692 935 883
josemanuel.fdez.fdez@gmail.com

2 BALEARES
María Antonia Garí
Tel. móvil 639 646 848
magari2109@gmail.com

5 CENTRO (Ávila, Ciudad Real, Cuenca, Guadalajara, Madrid, Segovia, Toledo)
Javier Martín Vera
Tel. móvil 689 841 107
ventas@vhventas.com

8 LEVANTE (Albacete, Alicante, Castellón, Murcia, Valencia)
Julián Florentín Jiménez
Tel. móvil 658 86 73 93
levante@docriluc.es

3 NORTE
Jorge Pascual
Tel. movil: 608 976 124
j.pascual5@cgac.es

6 EXTREMADURA
Alberto González
Tel. 618 012 776
agonzalez@docriluc.es

9 ISLAS CANARIAS
Sergio García Marrero Tel. 627 471 672
arje.center@gmail.com
Ignacio Acosta de León Tel. 645 603 328
arje.center.tfe@gmail.com

DEPARTAMENTO DE EXPORTACIÓN

EXPORT DEPARTMENT / DÉPARTEMENT EXPORT

Export back office:

Laura Ramírez: ✉ lramirez@docriluc.es

Tel. +34 957 51 01 26 / Fax. +34 957 51 06 82

Head of back office: Araceli Ecija ✉ aecija@docriluc.es



REPUESTOS
PARTS AND ACCESSORIES
PIÈCES DÉTACHÉES
Telf. +34 957 510 126
lramirez@docriluc.es



ASISTENCIA TÉCNICA
TECHNICAL ASSISTANCE
ASSISTANCE TECHNIQUE
Telf: 0034 689 491776
sat@docriluc.es

DEPARTAMENTO COMERCIAL

COMMERCIAL DEPARTMENT / DÉPARTEMENT COMMERCIAL

Back office:

M^a Luisa Morales: ✉ mluisamorales@docriluc.es

Vanessa: ✉ vporras@docriluc.es

Tel. +34 957 51 01 26 / Fax. +34 957 51 06 82



REPUESTOS
PARTS AND ACCESSORIES
PIÈCES DÉTACHÉES
Telf. +34 957 510 126
repuestos@docriluc.es



ASISTENCIA TÉCNICA
TECHNICAL ASSISTANCE
ASSISTANCE TECHNIQUE
Telf: +34 689 491776
sat@docriluc.es

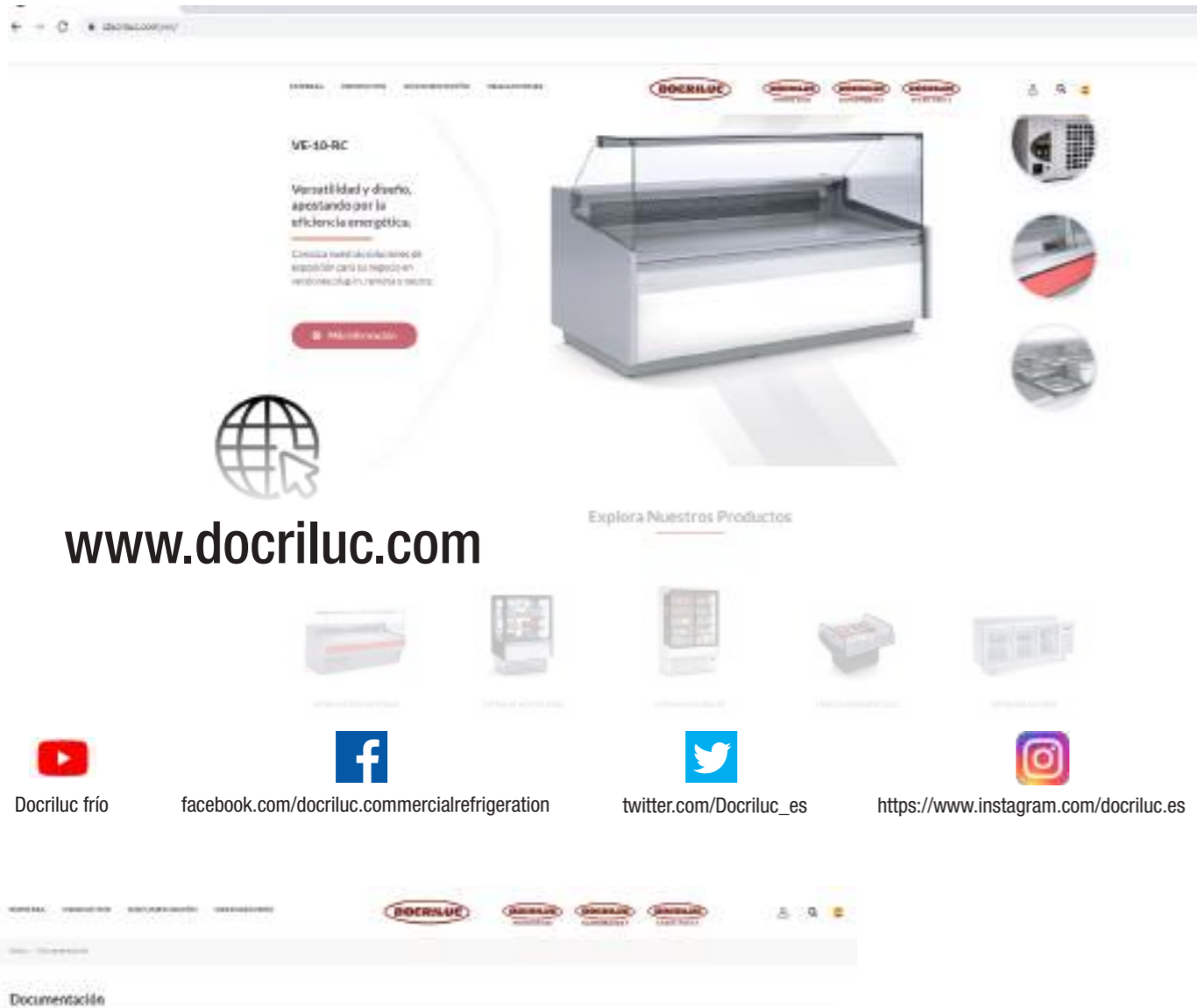

www.docriluc.com

 Docriluc frío
  facebook.com/docriluc.commercialrefrigeration
  twitter.com/Docriluc_es
  <https://www.instagram.com/docriluc.es>



DIRECCIÓN FÁBRICA
 Ctra. Córdoba - Málaga, km. 75,800 • (14900) LUCENA • (Córdoba) • ESPAÑA
 Telf.: 0034 957 51 01 26 • Fax: 0034 957 51 06 82
info@docriluc.es

SIMBOLOGÍA · SIMBOLISM · SYMBOLOGIE

 Largo Length Longueur	 Alto Height Hauteur	 Fondo Depth Profondeur	 Potencia Frig. Frig Power Puissance Frig.	 Consumo Consumption Consommation	 Potencia Power Puissance
 Capacidad Capacity Exposition	 Peso Neto Net Weight Poid Net	 Regulación temperatura Temperature set Temperature	 Tensión monofásica Single phase voltage Tension monophasique	 Refrig. Coolant Réfrigérant	 Rango Range Gamme
 Puertas Doors Portes	 Estantes Shelves Étagères	 Puertas cristal Glass doors Portes vitrés	 Puertas correderas Sliding doors Portes coulissantes	 Separador interior Shelves Séparateurs intérieurs	 Juego de guías Sets of slides Kit de guides
 Cajones Drawers Tiroirs	 Tolva Hopper	 Cajas Container Conteneur	 Cámara Camera Chambre	 Exposición Display Exposition	 Capacidad botellas Bottles capacity Capacité bouteilles
 Capacidad Capacity Exposition	 Huecos Door way Capacité	 Pantalla publicidad Canopy Marquise	 Capacidad platos Dish capacity Capacité de plat		

SECTOR DE ACTIVIDAD · ACTIVITY · ACTIVITÉ

 Charcutería Sausage market Marché Delicatessen	 Carnicería Butcher Shop Marché Aux Poissons	 Pescadería Fish Market Marché Aux Poissons	 Pastelería Pastry Shop Pâtisserie	 Panadería Bakery Boulangerie
 Frutería Fruit shop Fruit Market	 Pizzería, Sandwichería, Kebab Pizzeria, Sandwiches, Kebab Pizzeria, Sandwiches, Kebab	 Congelados Frozen Glacé	 Productos Lácteos Milk Products Produits Laitiers	 Bar, Restaurante, Cafetería, Hotel, Catering Bar, Restaurant, Coffee shop, Hotel, Catering Bar, Restaurant, Cafe, Hôtel, Restauration

DOCRILUC fabrica con la normativa CE en seguridad eléctrica y en compatibilidad electromagnética, cumpliendo las directivas del consejo DC-2004/108/CE y DC 2006/951/CE.

DOCRILUC gestiona en todos sus fabricados la calidad basándose en las normas que determinan la ISO-9001-2000.

DOCRILUC aplica el sistema de gestión ambiental determinado por la las normas ISO-14001.

DOCRILUC manufacture under CE standards in electrical, safety and electromagnetic compatibility, in compliance with DC DC-2004/108/CE 2006/951/CE directives.

DOCRILUC manage the quality in all their products under ISO-9001-2000 directives.

DOCRILUC apply environmental management system established by ISO-14001 standards.

DOCRILUC fabrique ces produits sous la norme CE en conformité en matière de sécurité électrique et compatibilité électromagnétique, suivant les directives du conseil DC DC-2004/108/CE 2006/951/CE.

DOCRILUC développe ses produits et en assure la qualité sur les bases des normes qui régissent l'ISO-9001-2000.

DOCRILUC applique le système de gestion environnemental que déterminent les normes ISO-14001



Directiva del Consejo DC de Seguridad eléctrica DC73/23CEE y de incompatibilidad electro-magnética DC89/336/CEE y su modificación por la directiva DC93/68/CEE.

Electrical safety of DC council directive DC73/23CEE, electromagnetic incompatibility DC89/336/CEE and its modification under DC93/68/CEE directives.

Directive du Conseil DC de sécurité électrique DC73/23CEE, et d'incompatibilité électromagnétique DC89/336/CEE et sa modification selon la directive DC93/68/CEE.



Todos nuestros fabricados están preparados para el cumplimiento del Reglamento CE852/2004 incorporando el módulo HACCP que se suministra bajo demanda.

All our products are under CE852/2004 directives and have HACCP module that is supplied on demand.

Tous nos produits ont les certifications CE852/2004 et incorporent le module HACCP qui vous est fourni sur demande.

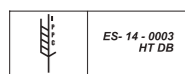

Certificamos que los embalajes y palets de madera que protegen nuestros productos son tratados con choque térmico certificado por nuestro proveedor en cumplimiento de las normas internacionales NIMF nº 15.

We certify that packaging and wooden pallets that protect our products are treated with heat shock certified by our supplier in compliance with international standards MIMF no. 15.

Nous certifions que les emballages et palettes en bois qui protègent nos produits sont traités par choc thermique. Notre fournisseur certifie par les normes internationales sont en conformité avec MIMF-N°15.



Nuestros productos cumplen con la normativa ROHS 2002/93/CE que determina la no utilización de sustancias peligrosas en determinadas concentraciones permitidas en aparatos eléctricos y electrónicos.

Our products are under RoHS 2002/93/EC directives that determines the non-use of hazardous substances in certain allowed concentrations in electrical and electronic equipments.

Nos produits sont sous les normes RoHS et la directive 2002/93/CE ce qui détermine la non-utilisation de substances dangereuses interdites à certaines concentrations utilisées dans les équipements électriques et électroniques.



Docriluc cumple con un sistema integrado de gestión de residuos de aparatos eléctricos y electrónicos

Docriluc meets an integrated management of waste electrical and electronic system

Docriluc répond à une gestion intégrée des déchets système électrique et électronique

EFICIENCIA ENERGETICA

Búsqueda constante de equipos altamente eficientes de acuerdo con la Directiva 2009/125/CE a través del Reglamento Delegado (UE) 2019/2024 (requisitos de diseño ecológico para aparatos de refrigeración con función de venta directa).

Cumplimiento de etiquetado energético de acuerdo con la Directiva 2010/30/UE + 2017/1369, a través del Reglamento Delegado (UE) 2019/2018 (ecoetiquetado de equipos de venta directa)

* La información relativa a la clase energética (según Reglamentos UE 2019/2018 y 2019/2024) se refiere a la mejor configuración disponible para estos modelos. Cualquier configuración diferente a la misma puede variar significativamente en la información relativa a la clase energética. Además, esta configuración se basa en la información disponible en el momento de la publicación de esta página.

Para más información, consulte la Base de Datos Europea de Productos de Etiquetado Energético EPREL o póngase en contacto con nuestro Departamento Comercial.

ENERGY EFFICIENCY

Constant search for highly efficient equipment in accordance with Directive 2009/125 / EC through Delegated Regulation (EU) 2019/2024 (eco-design requirements for refrigeration appliances with direct sales function).

Compliance with energy labeling in accordance with Directive 2010/30 / EU + 2017/1369, through Delegated Regulation (EU) 2019/2018 (eco-labeling of direct sales equipment)

* The information regarding the energy class (according to EU Regulations 2019/2018 and 2019/2024) refers to the best configuration available for these models. Another different configuration can vary significantly in the information about the energy class. Also, this setting is based on the information available at the time of publication of this page.

For more information, consult the European Database of Energy Labeling Products EPREL or contact our Commercial Department.

**ÍNDICE EFICIENCIA ENERGETICA
ENERGY EFFICIENCY CLASS**



EEI

EEI < 10
10 ≤ EEI < 20
20 ≤ EEI < 35
35 ≤ EEI < 50
50 ≤ EEI < 65
65 ≤ EEI < 80
80 ≤ EEI < 100

Nombre del fabricante / Supplier's name

Escala de clases de eficiencia energética / Energy efficiency class scale

Consumo anual en kWh / año / Annual consumption in kWh/year

Suma de las superficies de exposición con temperaturas de funcionamiento de refrigeración / Sum of display areas with chilled operating temperatures

Suma de las superficies de exposición con temperaturas de funcionamiento de congelación / Sum of display areas with frozen operating temperatures

Codigo QR / QR code

Identificador de modelo / Model identifier

Clase energética determinada / Energy class of the model

Rango de temperatura (valor máximo y mínimo) de las temperaturas de refrigeración / Temperature range (maximum and minimum value) of the chilled temperatures

Rango de temperatura (valor máximo y mínimo) de las temperaturas de congelación / Temperature range (maximum and minimum value) of the frozen temperatures

Reglamento 2019 / 2018 vigente / Current 2019 / 2018 regulation

	<p>PEDIDOS</p> <ul style="list-style-type: none"> • Todos los pedidos deberán cursarse por escrito (e-mail, carta, o fax). • No se podrá anular el pedido cuando se haya expedido o su fabricación es especial una vez comenzada la fabricación. • Queda reservado a admitir pedidos de aquellos clientes que hayan incumplido anteriores contratos. 	<p>ORDERS</p> <ul style="list-style-type: none"> • All orders must be made in writing by e-mail, letter or fax. • You may not cancel the order once issued, or if it involves a special product, once manufacturing has begun. • Docriluc reserves the right to refuse orders from customers who have failed previous contracts. 	<p>COMMANDES</p> <ul style="list-style-type: none"> • Toutes les commandes doivent être confirmées par écrit soit par e-mail, courrier ou télécopie. Sans cet écrit, elles ne seront pas prises en compte. • Vous ne pouvez pas annuler une commande lorsque celle-ci a été livrée. Toute commande spéciale, une fois mise en production, ne pourra pas faire l'objet d'une annulation. • Docriluc se réserve le droit de prendre les commandes des clients qui n'ont pas de précédent contrat.
	<p>PRECIOS</p> <ul style="list-style-type: none"> • Los precios de la tarifa correspondiente no incluye impuestos y son precios recomendados de venta al público Los precios se indican en euros. 	<p>PRICES</p> <ul style="list-style-type: none"> • Prices are recommended for retail, They are listed in Euros and are exempts of taxes. 	<p>PRIX</p> <ul style="list-style-type: none"> • Les prix sont indiqués en prix public recommandé. Ils sont en euros et hors taxe.
	<p>TRANSPORTE Y EMBALAJE</p> <ul style="list-style-type: none"> • La mercancía viajará a portes pagados. (Sólo en territorio español, excepto Ceuta, Melilla, islas Canarias y Baleares) • Las reexpediciones corren a cuenta y riesgo del comprador. • Todos los equipos incluyen embalaje individual 	<p>TRANSPORTATION AND PACKAGING</p> <ul style="list-style-type: none"> • Goods will be sent under carriage paid conditions, (Spanish territory, excepting Ceuta, Melilla Canary & Balear islands). • The reissues are at risk and cost of the buyer. • All equipments include individual packaging 	<p>TRANSPORT ET EMBALLAGE</p> <ul style="list-style-type: none"> • La marchandise est expédiée sous conditions de port payé seulement sur le territoire espagnol (à l'exception de Ceuta, Melilla et des Îles Canaries et Baléares). • Les retours de marchandises voyagent aux risques et aux frais de l'acheteur. • Toutes les marchandises sont conditionnées en emballage individuelle.
	<p>GARANTÍA</p> <ul style="list-style-type: none"> • Según certificado que se acompaña en cada producto. 	<p>WARRANTY</p> <ul style="list-style-type: none"> • According to the certificate of each product. 	<p>GARANTIE</p> <ul style="list-style-type: none"> • Elle s'applique selon le certificat de chaque produit.
	<p>DEVOLUCIONES</p> <ul style="list-style-type: none"> • No se admitirán devoluciones salvo que expresamente sea autorizado por Docriluc. • En todo caso el material debe remitirse libre de portes y gastos. 	<p>RETURNS</p> <ul style="list-style-type: none"> • Returns will not be accepted, unless Docriluc accept it. • In any case, goods must be sent free of freight cost. 	<p>RETOURS</p> <ul style="list-style-type: none"> • Si Docriluc ne donne pas son accord par écrit, aucun retour de marchandises ne sera acceptée.
	<p>CONDICIONES DE PAGO</p> <ul style="list-style-type: none"> • Hasta conceder crédito a un cliente, todas las operaciones serán abonadas mediante pago anticipado. • De no efectuarse el pago de las facturas en los vencimientos acordados, el cliente se hará cargo de los gastos de devolución y/o gastos de demora. 	<p>TERMS OF PAYMENT</p> <ul style="list-style-type: none"> • Before giving credit to a customer, all operations will be paid in advance. • In case that payment will not be done in the agreed maturity, customer will assume the return postage and / or costs of delay. 	<p>CONDITIONS DE REGLEMENT</p> <ul style="list-style-type: none"> • Toutes les commandes sont à régler avant expédition. • Dans le cadre de la mise en place de conditions de paiement différé, tout retard à l'échéance entraînera des frais de retour ou financier qui seront à la charge du client.
	<p>REPUESTOS Y ACCESORIOS</p> <ul style="list-style-type: none"> • Todos los repuestos se enviarán a portes debidos, no se admiten devoluciones de material salvo que sea autorizado por el servicio de asistencia técnica (SAT) 	<p>PARTS AND ACCESSORIES</p> <ul style="list-style-type: none"> • All parts will be sent carriage due, good refunds are not allowed unless Technical Support Service (TSS), authorize it. 	<p>PIÈCES DÉTACHÉES</p> <ul style="list-style-type: none"> • Toutes les pièces seront expédiées en port dû. Les retours ne sont pas acceptés sauf accord du service d'assistance technique (TSS).
	<p>DOMINIO</p> <ul style="list-style-type: none"> • Continuará siendo de Docriluc S,L, toda la mercancía que no esté totalmente pagada. 	<p>DOMAIN</p> <ul style="list-style-type: none"> • All unpaid merchandise, still belonging to Docriluc 	<p>CLAUSE DE PROPRIÉTÉ</p> <ul style="list-style-type: none"> • Toutes les marchandises non réglées restent la propriété de Docriluc.
	<p>JURISDICCIÓN</p> <ul style="list-style-type: none"> • En este caso serán competentes los tribunales de Lucena (Córdoba). 	<p>JURISDICTION</p> <ul style="list-style-type: none"> • In this case Lucena's courts in Córdoba are competent. 	<p>COMPÉTENCES JURIDIQUES</p> <ul style="list-style-type: none"> • Pour le règlement de tout litige, seuls sont compétents les tribunaux de la ville de LUCENA à la province de CORDOBA.
	<p>INFORMACIÓN</p> <ul style="list-style-type: none"> • Docriluc S,L, se reserva el derecho a introducir, sin previo aviso, las modificaciones que crea necesarias, sin que ello perjudique a las características principales de los productos • El comprador queda obligado a disponer, por su cuenta, los medios necesarios para la recepción de la mercancía 	<p>INFORMATION</p> <ul style="list-style-type: none"> • Docriluc S, L, reserves the right to make any necessary amendment / improvement, without notice and without detriment to the products' features. • The customer is required to provide, on his own, the necessary means for the reception of the goods. 	<p>INFORMATION</p> <ul style="list-style-type: none"> • Docriluc S.L. se réserve le droit d'apporter toute modification ou amélioration nécessaire au bon fonctionnement de ses produits, sans préavis et sans porter préjudice aux caractéristiques des produits. • C'est l'obligation de l'acheteur de disposer des ressources nécessaires pour la bonne réception de la marchandise.

1 **VITRINAS EXPOSITORAS**
Serve Over Counters
Vitrines
PAG 14



7 **ARMARIOS**
Cabinets
Armoire
PAG 302



2 **VITRINAS HOSTELERÍA**
Serve Over Counters Catering
Vitrines Hôtellerie
PAG 100



8 **ABATIDORES**
Cabinet
Armoires
PAG 356



3 **VITRINAS MURALES**
Multideck Displays
Mureaux
PAG 122



9 **GAMA AMERICANA**
US Range
Gamme Américaine
PAG 372



4 **LINEA SUPERMERCADOS**
Line Supermarket
Ligne Supermarché
PAG 146



10 **GAMA SPEED**
Speed Gamma
Gamma Speed
PAG 390



5 **ENFRIADORES**
Beverage coolers
Refrigerateur de boissons
PAG 212



11 **CÁMARAS Y EQUIPOS**
Frigorifield enclosures
Enclosures frigorifiques
PAG 422



6 **MESAS FRÍAS**
Cold Counter
Meuble Froid
PAG 258



12 **GALERÍA**
Gallery
Galerie
PAG 506

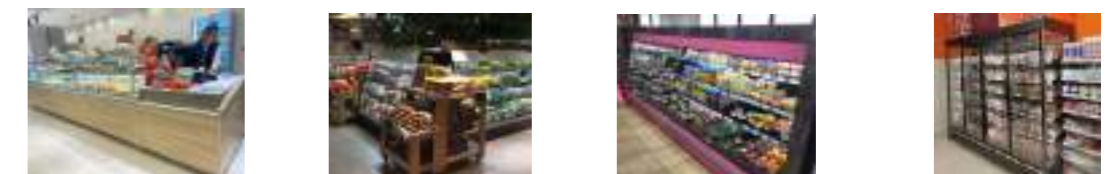

1

VITRINAS EXPOSITORAS

SERVE OVER COUNTERS

VITRINES



VE-8 Página 23
Vitrina expositora fondo 800
Serve over counters depth 800
Vitrines profondeur 800



VETB-10 Página 67
Vitrina expositora cubetas fondo 1100
Serve over counters tray depth 1100
Vitrines plateau profondeur 1100



VE-9 Página 27
Vitrina expositora fondo 940
Serve over counters depth 940
Vitrines profondeur 940



BM/HE/ES-10 Página 69
Vitrina expositora autoservicio fondo 1100
Serve over counters self-service depth 1100
Vitrines servis profondeur 1100



VEP-9 Página 35
Vitrina expositora pastelera fondo 940
Serve over counters Pastry Shop depth 940
Vitrines Pâtisserie profondeur 940



VE-10E-C Página 71
Vitrina expositora cristal elevable fondo 1100
Serve over counters glass lift depth 1100
Vitrines lift verre profondeur 1100



VEL-9 Página 41
Vitrina expositora fondo 940
Serve over counters depth 940
Vitrines profondeur 940



VE-10E-RC Página 73
Vitrina expositora cristal elevable fondo 1100
Serve over counters glass lift depth 1100
Vitrines lift verre profondeur 1100



VE-9-RC Página 45
Vitrina expositora pastelera fondo 960
Serve over counters Pastry Shop depth 960
Vitrines Pâtisserie profondeur 960



VEG-10 Página 77
Vitrina expositora fondo 1000
Serve over counters depth 1000
Vitrines profondeur 1000



EEC Página 51
Vitrina expositora terraza
Trolley refrigerated display
Armoire chariot



VEGP-10 Página 83
Vitrina expositora pastelera fondo 1000
Serve over counters Pastry Shop depth 1000
Vitrines Pâtisserie profondeur 1000



VE-9/10-P Página 53
Vitrina expositora pescado
Fish serve over counters
Vitrine poisson



VER-10 Página 89
Vitrina expositora pastelera fondo 1000
Serve over counters Pastry Shop depth 1000
Vitrines Pâtisserie profondeur 1000



VE-10 Página 59
Vitrina expositora fondo 1100
Serve over counter depth 1100
Vitrines gamme profondeur 1100



VEPR-10 Página 91
Vitrina expositora pastelera fondo 1000
Serve over counters Pastry Shop depth 1000
Vitrines Pâtisserie profondeur 1000



VE/VEA-10-RC Página 63
Vitrina expositora fondo 1100
Serve over counter depth 1100
Vitrines gamme profondeur 1100



VE-12 Página 95
Vitrina expositora supermarket fondo 1200
Serve over counters supermarket depth 1200
Vitrines supermarché profondeur 1200

Para acabados exteriores en alto brillo, fluorescentes, luminiscentes, consultar precio
 For exterior finishes in high gloss, fluorescent, luminescent, consult price
 Pour finitions extérieures en brillant, fluorescent, luminescent, consulter le prix

CARTA DE ACABADOS
 COLOR · COULEUR

FRANJA ESTÁNDAR
 STANDARD STRIP · STANDARD BANDE







 RAL-9003	 RAL-9005	 RAL-4010		
 RAL-2011	 PANTONE 7606C	 PANTONE 543C		
 RAL-1018	 RAL-3015	 PANTONE 5523C		
 ROBLE	 RAL 7024	 RAL-6001	 PANTONE 2298C	 PANTONE 7604C
 HAYA	 NOGAL	 RAL-3020	 RAL-5023	 PANTONE 5865
 WENGUE	 DECORACIÓN INOX	 PANTONE 4725C	 RAL-5003	 PANTONE 2408C

FRONTAL COMPLETO
 FULL FRONTAL DECORATION · PLEIN DECORATION FRONTAL

INCREMENTO 1 · INCREASE 1 · AUGMENTER 1

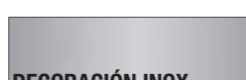





 WENGUE	 NOGAL
 ROBLE	 DECORACIÓN INOX
 HAYA	



DECORACIÓN TOTAL
 TOTAL DECOR · DÉCORATION TOTAL

INCREMENTO 2 · INCREASE 2 · AUGMENTER 2



 WENGUE	 NOGAL
 ROBLE	
 HAYA	



OPCIONES DE CRISTALES
 GLASS OPTIONS · OPTIONS EN VERRE



VE-R: Cristal recto
 VE-R: Straight glass
 VE-R: Verre droit



VE-C: Cristal curvo
 VE-C: Curved glass
 VE-C: Verre bombé



EEC-CC: Cristal doble curvo
 EEC-CC: Double curved glass
 EEC-CC: Double verre bombé



VEP-RR: Cristal doble recto pastelería
 VEP-RR: Bakery double straight glass
 VEP-RR: Double verre droit pâtisserie



VE-RR: Cristal doble recto
 VE-RR: Double straight glass
 VE-RR: Double verre droit



VE-RCB: Cristal recto bajo
 VE-RCB: Low straight glass
 VE-RCB: Verre droit bas

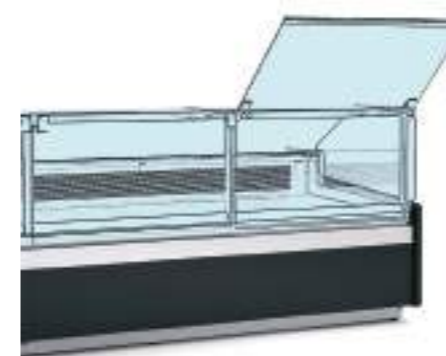

VE-E-RR: Cristal recto elevable
 VE-E-RR: Lifiable straight glass
 VE-E-RR: Verre droit relevable



VE-E-C: Cristal curvo elevable
 VE-E-C: Lifiable curved glass
 VE-E-C: verre bombé relevable



VEA: Cristal autoservicio
 VEA: Self service glass
 VEA: Verre en libre service

NOVEDADES CONSTRUCTIVAS

CONSTRUCTIVE FEATURES • CARACTÉRISTIQUES CONSTRUCTIVES

Todos los vidrios templados y securizados
All tempered and secure glass
Tout verre trempé et sécurisé

Todos los estantes intermedios iluminados
All middle shelves illuminated
Toutes les étagères du milieu éclairées

Lateral en ABS
Side in ABS
Côté en ABS

Nuevo sistema de fijación para vidrios
New glass fixing system
Nouveau système de fixation du verre

Iluminación led integrado con mayor potencia lumínica
Integrated LED lighting with greater light output
Éclairage LED intégré avec une plus grande puissance lumineuse

Iluminación LED en frontal bajo
Low front LED lighting
Éclairage LED bas à l'avant

Sistema semi-ventilado optimizado
Optimized semi-ventilated system
Système semi-ventilé optimisé

Nueva perfilera de aluminio: diseño compacto con líneas rectas
New aluminum profiles: compact design with straight lines
Nouveaux profilés en aluminium : design compact aux lignes droites

Nuevo sistema de ensamblaje uniforme y preciso para uniones modulares y ángulos
New uniform and precise assembly system for modular joints and angles
Nouveau système d'assemblage uniforme et précis pour les joints et les angles modulaires

CARACTERÍSTICAS TÉCNICAS GENERALES	GENERAL TECHNICAL DATA	CARACTÉRISTIQUES TECHNIQUES GÉNÉRAL
<ul style="list-style-type: none"> Exterior e interior en chapa de acero plastificada Plano exposición y encimera en acero inox. AISI-304 Bandejas plano de exposición lisas, con escalón sobre demanda Costados de 30 mm en ABS inyectado Perfilería en aluminio anodizado. Paragolpes en la parte delantera Cristal frontal templado y abatible, varias versiones disponibles Estante de cristal intermedio iluminado, no refrigerado Iluminación estándar: encimera superior y estante LED Aislamiento de poliuretano inyectado, libre CFCs, densidad 40 Kg/m³ Reserva refrigerada con puertas, hueco 440x270 (excepto modelo neutro y modelo sin reserva) Evaporador tratado epoxi Condensación ventilada y evaporación automática de serie Modelos preinstalación incorporan valvulería solenoide y expansión en R-449A, opción R-134a Control electrónico de temperatura Descarche automático, opcional eléctrico Clase climática 4 (30 °C 55% Hr) régimen M1 según UNE-EN ISO 23953-2 Chasis en acero acabado epoxi Tensión de trabajo monofásica 220V 50Hz Modelos cristal R: Cristal recto Modelos cristal C: Cristal curvo Modelos cristal RR: Cristal doble recto Kits de union: Para instalaciones especiales, lineales y ángulos consulte precio 	<ul style="list-style-type: none"> Interior and exterior finish in plastic coated steel Display area and counter in stainless steel AISI-304 Smooth deck for display area, stepped at on demand Sides available in ABS injected, 30 mm thickness Anodised aluminium profiles Front rubber bumper Toughened curved glass hinges forward, several models available Illuminated glass shelf, non refrigerated Standard lighting: top worktop and shelf LED 40 Kg/m³ density polyurethane insulation, low GWP and zero ODP effect Refrigerated under storage with doors 440x270 free, (except neutral model and model without reservation) Evaporator with epoxy treatment Ventilated condensation and automatic defrost evaporation as standard Pre-installation models incorporate solenoid valve and expansion in R-449A, option R-134a Electronic temperature control with indicator Automatic defrost, electric as optional Climatic class 4 (30 °C 55% Hr) regime M1 according to UNE-EN ISO 23953-2 Working voltage single phase 220V 50Hz Chassis in epoxy finished steel Glass models R: Flat glass Glass models C: Curved glass Glass models RR: Double flat glass Union kits: For special installations, linear and angles see price 	<ul style="list-style-type: none"> Extérieur et intérieur en acier plastifié. Surface d'exposition et plan de travail en inox. AISI-304 Surface d'exposition lisse, possibilité double niveau sur demande Côtes en ABS thermoformé, épaisseur 30 mm., différentes versions disponibles Profilés en aluminium anodise Pare-chocs en partie frontale Vitre droite ou bombée sécurit rabattable Etagère en verre illuminé, non réfrigérée Lumière standard en partie haute et étagère LED Isolation en polyuréthane injecté sans CFC, densité 40Kg/m³ Stockage réfrigéré, espace 440x270 (sauf modèle neutre et le modèle sans réserve) Époxi évaporateur traité Condensation ventilé, évaporation automatique en standard Les modèles de pré-installation incorporent l'électrovanne et l'expansion R-449A en option R-134a Contrôle électronique de température con indicador Dégivrage automatique, électrique en option Classe climatique 4 (30 °C 55% Hr) régime M1 selon UNE-EN ISO 23953-2 Tension de fonctionnement monophasé 220V 50Hz Châssis en acier fini époxy Modèles verre R: Verre droit Modèles verre C: Verre courbé Modèles verre RR: Verre double droit Kits Union: Pour installations spéciales, linéaires et angles voir prix

VE	VES	DIFERENCIAS / DIFFERENCES / DIFFÉRENCES	
		<ul style="list-style-type: none"> Reserva y con puertas Reserve with doors Réservez avec portes 	<ul style="list-style-type: none"> Sin reserva y sin puertas Without reservation and without doors Sans réservation et sans portes

VE	VE-TF	DIFERENCIAS / DIFFERENCES / DIFFÉRENCES	
		<ul style="list-style-type: none"> Refrigeración estática por gravedad, mayor espacio en la reserva Static cooling by gravity, more space in reserve Refroidissement statique par gravité, plus d'espace en réserve 	<ul style="list-style-type: none"> Refrigeración tiro forzado semi-ventilado impulsado por ventiladores, mejor distribución de frío Semi-forced draft cooling boosted by fans, better distribution of cold Projet de ventilateur de refroidissement semi-forcée entraînée par les fans, une meilleure distribution de froid

DETALLES / DETAIL / DÉTAIL			
<p>Cuadro de mandos con enchufe 500w main control panel with 500w plug tableau de bord avec 500w plug</p>	<p>Detalle separador de genero Detail separator genre Détail séparateur de genre</p>	<p>Detalle perfilera anodizada Anodized profiles detail Profilés anodisés détail</p>	<p>Detalle evaporación automática Automatic evaporation detail Détail d'évaporation automatique</p>
<p>Detalle cierre cortina Curtain closure detail Détail de fermeture de rideau</p>	<p>Detalle cierre plexi Detail plexiglas closing Détail fermeture en plexiglas</p>	<p>Detalle cubetas encastrables Built-in buckets detail Détail des seaux intégrés</p>	<p>Otras tensiones / frecuencias Other tensions Autre tensione</p> <p>230v / 60 Hz 115v / 60 Hz</p>

CARACTERÍSTICAS TÉCNICAS

- Exterior e interior en chapa de acero plastificada
- Plano exposición y encimera en acero inox. AISI-304
- Bandejas plano de exposición lisas, con escalón sobre demanda
- Costados de 30 mm en ABS inyectado
- Perfilera en aluminio anodizado.
- Paragolpes en la parte delantera
- Cristal frontal templado y abatible, dos versiones disponibles
- Estante de cristal intermedio iluminado, no refrigerado
- Iluminación estándar LED: encimera superior, estante y frontal bajo
- Aislamiento de poliuretano inyectado, libre CFCs, densidad 40 Kg/m³
- Reserva refrigerada con puertas, hueco 440x270 (excepto modelo neutro)
- Evaporador estático tratado epoxi
- Condensación ventilada y evaporación automática de serie
- Control electrónico de temperatura
- Descarche automático, opcional eléctrico
- Clase climática 4 (30°C 55% Hr) régimen M1 según UNE-EN ISO 23953-2
- Chasis en acero acabado epoxi
- Tensión de trabajo monofásica 220V 50Hz

TECHNICAL DATA

- Interior and exterior finish in plastic coated steel
- Display area and counter in stainless steel AISI-304
- Smooth deck for display area, stepped at on demand
- Sides available in ABS injected, 30 mm thickness
- Anodised aluminium profiles
- Front rubber bumper
- Toughened curved glass hinges forward, two versions available
- Illuminated glass shelf, non refrigerated
- Standard lighting LED: top worktop, shelf and low panel
- 40 Kg/m³ density polyurethane insulation, low GWP and zero ODP effect
- Refrigerated under storage with doors 440x270 free, (except neutral model)
- Static evaporator with epoxy treatment
- Ventilated condensation and automatic defrost evaporation as standard
- Electronic temperature control with indicator
- Automatic defrost, electric as optional
- Climatic class 4 (30 ° C 55% Hr) regime M1 according to UNE-EN ISO 23953-2
- Working voltage single phase 220V 50Hz
- Chassis in epoxy finished steel

CARACTÉRISTIQUES TECHNIQUES

- Extérieur et intérieur en acier plastifié.
- Surface d'exposition et plan de travail en inox. AISI-304
- Surface d'exposition lisse, possibilité double niveau sur demande
- Côtes en ABS thermoformé, épaisseur 30 mm., différentes versions disponibles
- Profilés en aluminium anodisé
- Pare-chocs en partie frontale
- Vitre droite ou bombée sécurit rabattable
- Étagère en verre illuminé, non réfrigérée
- Lumière standard en partie haute, étagère et front bas LED
- Isolation en polyuréthane injecté sans CFC, densité 40Kg/m³
- Stockage réfrigéré, espace 440x270 (sauf modèle neutre)
- Époxy évaporateur statique traité
- Condensation ventilé, évaporation automatique en standard
- Contrôle électronique de température con indicador
- Dégivrage automatique, électrique en option
- Classe climatique 4 (30 ° C 55% Hr) régime M1 selon UNE-EN ISO 23953-2
- Tension de fonctionnement monophasé 220V 50Hz
- Châssis en acier fini époxy



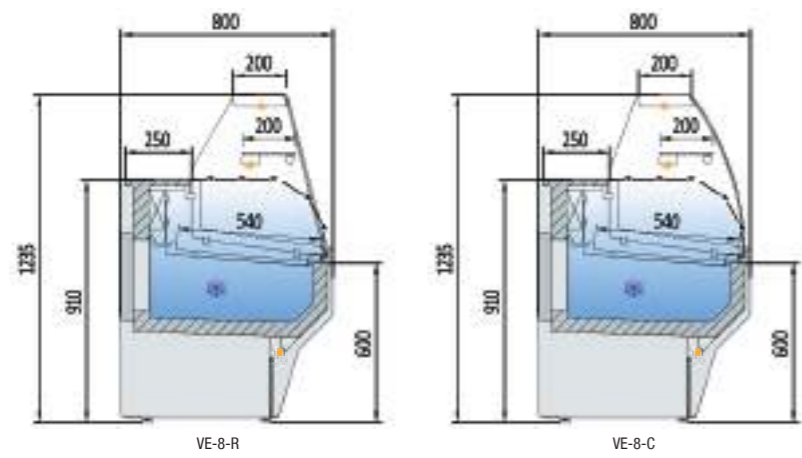

4000K RED FRESH



detalle plano de exposición
display area detail
Up détail de l'exposition

detalle perfiles anodizada
anodized profiles detail
profilis anodisés détail

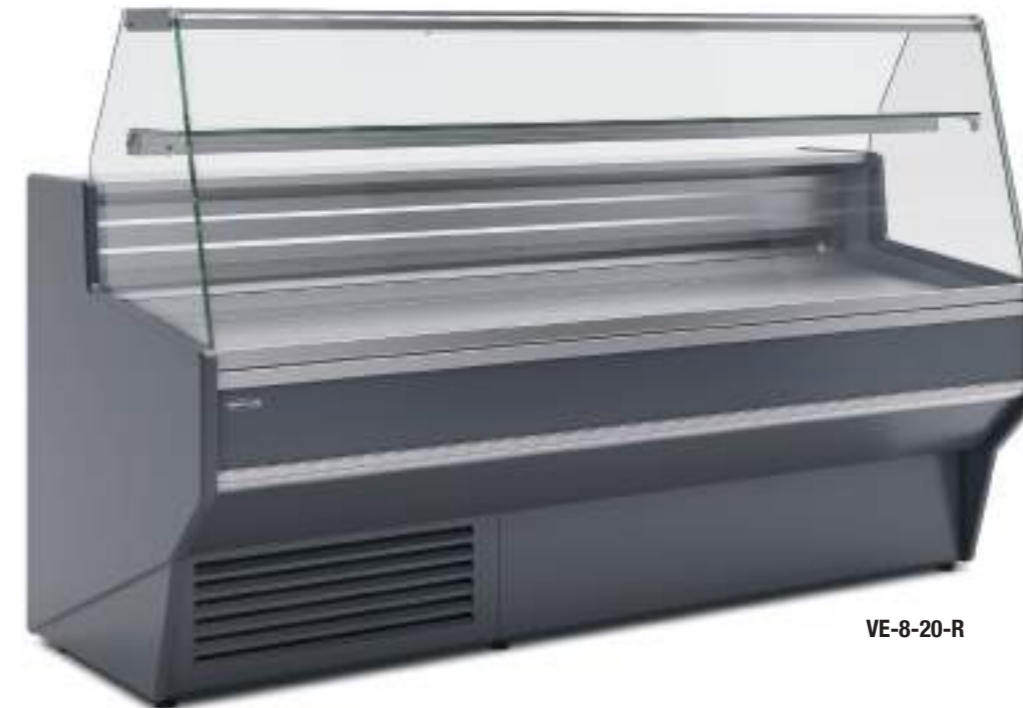

VE-8-20-R



VE-8-20-C

Ver características técnicas en página 20 / See technical data in page 20 / Voir caractéristiques techniques page 20

Modelo Model Modèle	Largo Length Longueur (mm)	Superficie de exposición Display area Surface d'exposition (m²)	Superficie total de exposición (TDA) Total display area (TDA) Surface totale de l'exposition (TDA) (m²)		Cámara VE Storage VE Stockage VE (lts.)	Puertas Doors Portes (Uds)	Potencia frig. Frig. Power Puissance frig. (W)	Consumo Nominal Nominal power Consommation nominale (W)	Refrigerante Coolant Réfrigérant
			(R)	(C)					
VE-8-10	1025	0,68	0,48	0,48	246	1	565	830	R-290
VE-8-13	1265	0,85	0,60	0,60	309	2	572	891	R-290
VE-8-15	1505	1,01	0,72	0,72	373	2	781	1011	R-290
VE-8-20	1985	1,35	0,95	0,95	499	3	949	1099	R-290
VE-8-25	2465	1,69	1,19	1,19	626	4	1284	1298	R-290
VE-8-30	2945	2,03	1,43	1,43	752	4	1284	1322	R-290

230v 60Hz / 115v 60Hz. consultar - consult - consulter

*Modelos en HFC, consultar precio / HFC Models, consult prices / Modèles HFC, consulter prix

PVP de opcionales incluidos en equipo, no como repuesto / PVP of options included in the equipment, not as a spare part / PVP d'options incluses dans l'équipement, pas en tant que pièce de rechange

Modelo Model Modèle	OPCIONES · OPTIONS · OPTIONS		Cierre Plexi Plexi slide Doors Kit vitrage arrière coulissant plexi	Iluminación led extra Extra led lighting Eclairage led extra	Cierre cortina Night blind Rideau nocturne	Neutra Neutral Neutre	Pre Instalación Remote Unit Groupe à distance
	1 decoración frontal / front decor / décoration frontal	2 Total decoración / Total decor / décoration total					
VE-8-10	140 €	460 €	118 €	57 €	175 €	-410 €	-120 €
VE-8-13	150 €	471 €	173 €	78 €	242 €	-460 €	-135 €
VE-8-15	164 €	481 €	201 €	93 €	292 €	-510 €	-145 €
VE-8-20	174 €	489 €	252 €	112 €	321 €	-615 €	-180 €
VE-8-25	184 €	495 €	335 €	148 €	378 €	-870 €	-205 €
VE-8-30	194 €	502 €	397 €	160 €	581 €	-995 €	-255 €

Características técnicas y constructivas sujetas a variación sin previo aviso. / We reserve the right to change specifications without prior notice. / Sujet technique et la conception de modifications sans préavis.

Laterales incluidos en PVP / Sides included in PVP / Latéraux inclus dans PVP

VE-8-10-R 2.113 €	VE-8-13-R 2.339 €	VE-8-15-R 2.497 €	VE-8-20-R 3.138 €	VE-8-25-R 3.587 €	VE-8-30-R 4.387 €
VE-8-10-C 2.260 €	VE-8-13-C 2.504 €	VE-8-15-C 2.734 €	VE-8-20-C 3.311 €	VE-8-25-C 3.873 €	VE-8-30-C 4.659 €



CARACTERÍSTICAS TÉCNICAS

- Exterior e interior en chapa de acero plastificada
- Plano exposición y encimera en acero inox. AISI-304
- Bandejas plano de exposición lisas, con escalón sobre demanda
- Costados de 30 mm en ABS inyectado
- Perfilera en aluminio anodizado.
- Paragolpes en la parte delantera
- Cristal frontal templado y abatible, dos versiones disponibles
- Estante de cristal intermedio, no refrigerado
- Iluminación estándar LED: encimera superior, estante y frontal bajo
- Aislamiento de poliuretano inyectado, densidad 40 Kg/m³, bajo GWP y cero efecto ODP
- Reserva refrigerada con puertas, hueco 440x270 (excepto modelo neutro y modelo sin reserva)
- Evaporador estático, opcional ventilado
- Condensación ventilada y evaporación automática de serie
- Control electrónico de temperatura
- Descarche automático, opcional eléctrico
- Clase climática 4 (30°C 55% Hr) régimen M1 según UNE-EN ISO 23953-2
- Chasis en acero acabado epoxi
- Tensión de trabajo monofásica 220V 50Hz

TECHNICAL DATA

- Interior and exterior finish in plastic coated steel
- Display area and counter in stainless steel AISI-304
- Smooth deck for display area, stepped at on demand
- Sides available in ABS injected, 30 mm thickness
- Anodised aluminium profiles
- Front rubber bumper
- Toughened curved glass hinges forward, two versions available
- Glass shelf non refrigerated
- Standard lighting LED: top worktop and shelf
- 40 Kg/m³ density polyurethane insulation, low GWP and zero ODP effect
- Refrigerated under storage with doors 440x270 free (except neutral model and model without reservation)
- Static evaporator, ventilated as optional
- Ventilated condensation and automatic defrost evaporation as standard
- Electronic temperature control
- Automatic defrost, electric as optional
- Climatic class 4 (30 ° C 55% Hr) regime M1 according to UNE-EN ISO 23953-2
- Working voltage single phase 220V 50Hz
- Chassis in epoxy finished steel

CARACTÉRISTIQUES TECHNIQUES

- Extérieur et intérieur en acier plastifié.
- Surface d'exposition et plan de travail en inox. AISI-304
- Bacs planes à surface d'exposition, possibilité double niveau sur demande
- Côtés en ABS thermoformé, épaisseur 30 mm.
- Profilés en aluminium anodisé
- Pare-chocs en partie frontale
- Vitre droite ou bombée sécurit rabattable
- Étagère en verre non réfrigérée
- Lumière standard en partie haute LED
- Isolation en polyuréthane injecté sans CFC, densité 40Kg/m³
- Stockage réfrigéré, espace 440x270 (sauf modèle neutre et le modèle sans réserve)
- Evaporateur statique
- Condensation ventilé, évaporation automatique en standard
- Contrôle électronique de la température
- Dégivrage automatique, électrique en option
- Classe climatique 4 (30 ° C 55% Hr) régime M1 selon UNE-EN ISO 23953-2
- Tension de fonctionnement monophasé 220V 50Hz
- Châssis en acier fini époxy



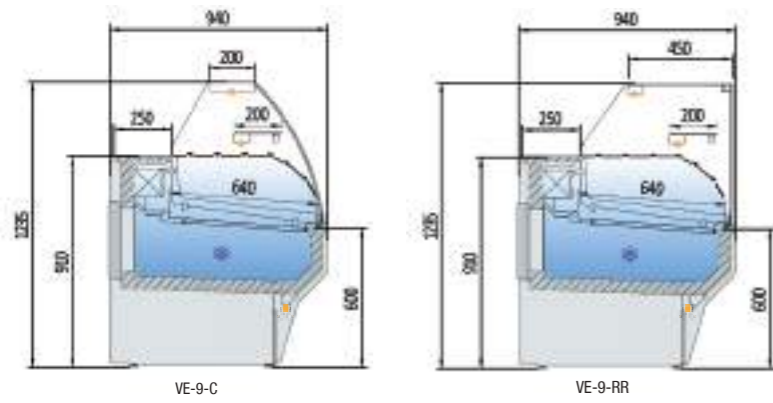

4000K RED FRESH



detalle plano de exposición
display area detail
Up détail de l'exposition

detalle periferia anodizada
anodized profiles detail
profilis anodisés détail



VE-9-20-C



VE-9-15-RR

Ver características técnicas en página 24 / See technical data in page 24 / Voir caractéristiques techniques page 24

Modelo Model Modèle	Largo Length Longueur (mm)	Superficie de exposición Display area Surface d'exposition (m²)	Superficie total de exposición (TDA) Total display area (TDA) Surface totale de l'exposition (TDA) (m²)		Cámara VE Storage VE Stockage VE (lts.)	Puertas Doors Portes (Uds)	Potencia frig. Frig. Power Puissance frig. (W)	Consumo Nominal Nominal power Consommation nominale (W)	Refrigerante Coolant Réfrigérant
			(RR)	(C)					
VE-9-10	1025	0,77	0,76	0,62	299	1	565	830	R-290
VE-9-13	1265	0,96	0,95	0,78	376	2	572	891	R-290
VE-9-15	1505	1,15	1,14	0,93	452	2	781	1011	R-290
VE-9-20	1985	1,54	1,52	1,24	606	3	1098	1234	R-290
VE-9-25	2465	1,92	1,90	1,55	759	4	1284	1298	R-290
VE-9-30	2945	2,30	2,28	1,86	913	4	1284	1322	R-290

230v 60Hz / 115v 60Hz. consultar - consult - consulter

*Modelos en HFC, consultar precio / HFC Models, consult prices / Modèles HFC, consulter prix

PVP de opcionales incluidos en equipo, no como repuesto / PVP of options included in the equipment, not as a spare part / PVP d'options incluses dans l'équipement, pas en tant que pièce de rechange

Modelo Model Modèle	OPCIONES · OPTIONS · OPTIONS		Cierre Plexi Plexi slide Doors Kit vitrage arrière coulissant plexi	Iluminación led extra Extra led lighting Eclairage led extra	Plano de exposición hermético Plane of airtight exhibition Avion de exposition hermétique	Neutra Neutral Neutre	Pre Instalación Remote Unit Groupe à distance
	1 decoración frontal / front decor / décoration frontal	2 Total decoración / Total decor / décoration total					
VE-9-10	140 €	460 €	118 €	57 €	75 €	-410 €	-120 €
VE-9-13	150 €	471 €	173 €	78 €	86 €	-460 €	-135 €
VE-9-15	164 €	481 €	201 €	93 €	100 €	-510 €	-145 €
VE-9-20	174 €	489 €	252 €	112 €	125 €	-615 €	-180 €
VE-9-25	184 €	495 €	335 €	148 €	174 €	-870 €	-205 €
VE-9-30	194 €	502 €	397 €	160 €	205 €	-995 €	-255 €

Características técnicas y constructivas sujetas a variación sin previo aviso. / We reserve the right to change specifications without prior notice. / Sujet technique et la conception de modifications sans préavis.

Laterales incluidos en PVP / Sides included in PVP / Latéraux inclus dans PVP

VE-9-10-RR 2.371 €	VE-9-13-RR 2.615 €	VE-9-15-RR 2.837 €	VE-9-20-RR 3.455 €	VE-9-25-RR 4.034 €	VE-9-30-RR 4.829 €
VE-9-10-C 2.371 €	VE-9-13-C 2.615 €	VE-9-15-C 2.837 €	VE-9-20-C 3.455 €	VE-9-25-C 4.034 €	VE-9-30-C 4.829 €

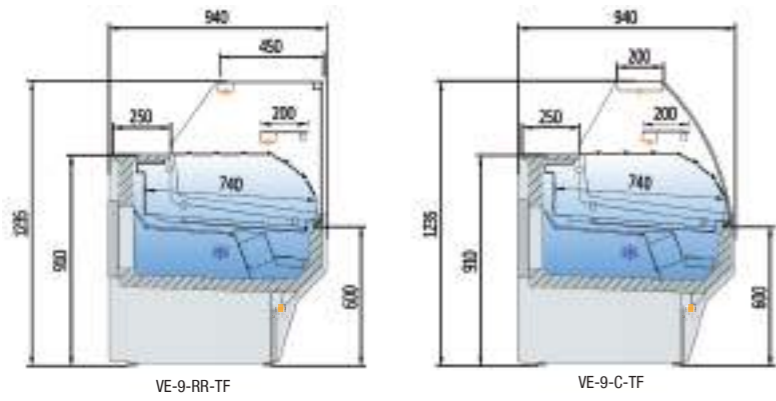

Modelo con reserva VE
 Model with reservation VE
 Modèle avec réserve VE

Ver características técnicas en página 24 / See technical data in page 24 / Voir caractéristiques techniques page 24

Modelo Model Modèle	Largo Length Longueur (mm)	Superficie de exposición Display area Surface d'exposition (m²)	Superficie total de exposición (TDA) Total display area (TDA) Surface totale de l'exposition (TDA) (m²)		Cámara VE Storage VE Stockage VE (Its.)	Puertas Doors Portes (Uds)	Potencia frig. Frig. Power Puissance frig. (W)	Consumo Nominal Nominal power Consommation nominale (W)	Refrigerante Coolant Réfrigérant
			(C)	(RR)					
VE-9-10-TF	1025	0,86	0,62	0,76	242	1	565	851	R-290
VE-9-13-TF	1265	1,08	0,78	0,95	304	2	572	912	R-290
VE-9-15-TF	1505	1,29	0,93	1,14	366	2	781	1046	R-290
VE-9-20-TF	1985	1,72	1,24	1,52	491	3	1098	1290	R-290
VE-9-25-TF	2465	2,15	1,55	1,9	615	4	1284	1354	R-290
VE-9-30-TF	2945	2,58	1,86	2,28	739	4	1284	1378	R-290

230v 60Hz / 115v 60Hz. consultar - consult - consulter

*Modelos en HFC, consultar precio / HFC Models, consult prices / Modèles HFC, consulter prix

PVP de opcionales incluidos en equipo, no como repuesto / PVP of options included in the equipment, not as a spare part / PVP d'options incluses dans l'équipement, pas en tant que pièce de rechange

Modelo Model Modèle	OPCIONES · OPTIONS · OPTIONS		Cierre Plexi Plexi slide Doors Kit vitrage arrière coulissant plexi	Iluminación led extra Extra led lighting Eclairage led extra	Cierre cortina Night blind Rideau nocturne	Neutra Neutral Neutre	Pre Instalación Remote Unit Groupe à distance
	1 decoración frontal / front decor / décoration frontal	2 Total decoración / Total decor / décoration total					
VE-9-10-TF	140 €	460 €	118 €	57 €	175 €	-410 €	-120 €
VE-9-13-TF	150 €	471 €	173 €	78 €	242 €	-460 €	-135 €
VE-9-15-TF	164 €	481 €	201 €	93 €	292 €	-510 €	-145 €
VE-9-20-TF	174 €	489 €	252 €	112 €	321 €	-615 €	-180 €
VE-9-25-TF	184 €	495 €	335 €	148 €	378 €	-870 €	-205 €
VE-9-30-TF	194 €	502 €	397 €	160 €	581 €	-995 €	-255 €

Características técnicas y constructivas sujetas a variación sin previo aviso. / We reserve the right to change specifications without prior notice. / Sujet technique et la conception de modifications sans préavis.

□□□□□ 4000K
 ●●●●● RED FRESH



VE-9-25-C-TF



VE-9-15-RR-TF

Laterales incluidos en PVP / Sides included in PVP / Latéraux inclus dans PVP

VE-9-10-C-TF 2.452 €	VE-9-13-C-TF 2.777 €	VE-9-15-C-TF 3.062 €	VE-9-20-C-TF 3.570 €	VE-9-25-C-TF 4.178 €	VE-9-30-C-TF 5.194 €
VE-9-10-RR-TF 2.452 €	VE-9-13-RR-TF 2.777 €	VE-9-15-RR-TF 3.062 €	VE-9-20-RR-TF 3.570 €	VE-9-25-RR-TF 4.178 €	VE-9-30-RR-TF 5.194 €

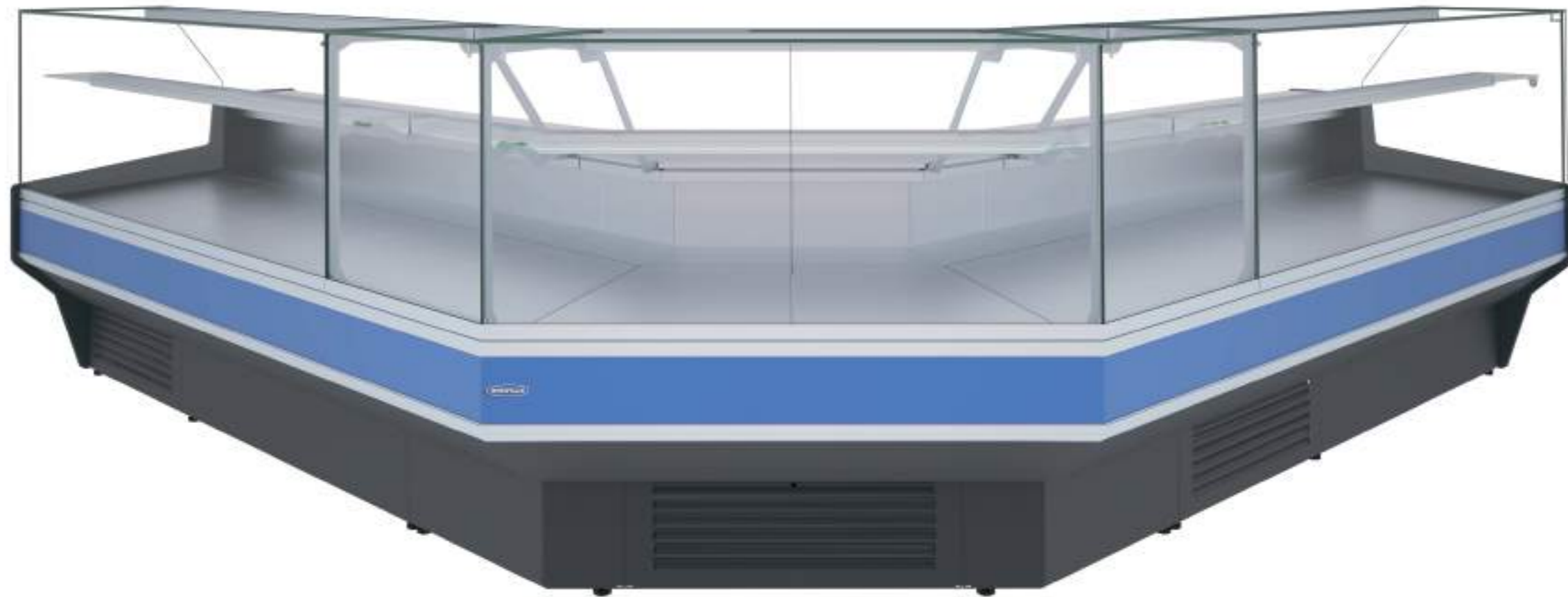

Ver características técnicas en página 24 / See technical data in page 24 / Voir caractéristiques techniques page 24

CARACTERÍSTICAS TÉCNICAS ÁNGULOS REFRIGERADOS

- Sistema de evaporación ventilado
- Modelos AP45 y AN45 neutros
- **C:** Cristal curvo
- **RR:** Cristal doble recto
- Mismo precio para cristales **C** y **RR**

REFRIGERATED ANGLE TECHNICAL DATA

- Ventilated evaporation system
- Neutral models AP45 y AN45
- **C:** Curved glass
- **RR:** Double flat glass
- Same price for glass **C** and **RR**

CARACTÉRISTIQUES TECHNIQUES DES ANGLES RÉFRIGÉRÉS

- Système d'évaporation ventilé
- Modèles AP45 y AN45 neutros
- **C:** Vitre bombée
- **RR:** Vitre double droit
- Même prix pour le verre **C** et **RR**

Laterales incluidos en PVP / Sides included in PVP / Latéraux inclus dans PVP

CARACTERÍSTICAS TÉCNICAS MUEBLES CAJAS

- Todos los modelos con cajón incorporado, estantes y enchufe
- Modelo MCVE-DIS frontal adaptado a discapacitados
- Modelo MCVE frontal recto

CASH NEUTRAL COUNTER DATA

- All models with built-in drawer, shelves and plug
- Front MCVE-DIS model adapted for the disabled
- Straight front MCVE model

CARACTÉRISTIQUES TECHNIQUES DES MEUBLE CAISSE

- Tous les modèles avec tiroir intégré, étagères et prise
- Modèle avant MCVE-DIS adapté aux handicapés
- Modèle MCVE à façade droite

DETALLE FRONTAL / FRONT DETAIL
DÉTAIL AVANT



Modelo Model Modèle	Total decoración Total decor Décoration total
MCVE-9-8-DIS	460 €
MCVE-9-8	460 €
MCVE-9-12-DIS	471 €
MCVE-9-12	471 €

MUEBLES CAJA NEUTROS
CASH NEUTRAL COUNTER / MEUBLE CAISSE NEUTRE

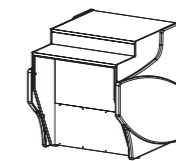

MCVE-9-8-DIS **1.261 €**
MCVE-9-8 **1.261 €**

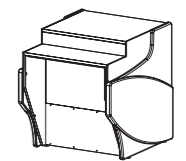

MCVE-9-12-DIS **1.314 €**
MCVE-9-12 **1.314 €**

ÁNGULOS NEGATIVOS / NEGATIVE ANGLES / NÉGATIF ANGLES

VE-9-RN90 5.763 €	VE-9-AN90 5.763 €	VE-9N-AN45 4.108 €

ÁNGULOS POSITIVOS / POSITIVE ANGLES / POSITIF ANGLES

VE-9-RP90 5.749 €	VE-9-AP90 5.749 €	VE-9N-AP45 4.056 €

230v 60Hz / 115v 60Hz. consultar - consult - consulter

*Modelos en HFC, consultar precio / HFC Models, consult prices / Modèles HFC, consulter prix

PVP de opcionales incluidos en equipo, no como repuesto / PVP of options included in the equipment, not as a spare part / PVP d'options incluses dans l'équipement, pas en tant que pièce de rechange

OPCIONES · OPTIONS · OPTIONS

Modelo Model Modèle	1 decoración frontal / front decor / décoration frontal	2 Total decoración / Total decor / décoration total	Cierre Plexi Plexi slide Kit vitrage coulissant plexi	Iluminación led led lighting Éclairage Led blanc
VE-9-AP90	 156 €	 502 €	271 €	93 €
VE-9-RP90	 156 €	 502 €	271 €	93 €
VE-9-AN90	 156 €	 502 €	271 €	93 €
VE-9-RN90	 156 €	 502 €	271 €	93 €
VE-9-AP45	 156 €	 502 €	118 €	93 €
VE-9-AN45	 156 €	 502 €	118 €	93 €

Modelo Model Modèle	Largo Length Longueur (mm)	Alto Height Hauteur (mm)	Fondo Depth Profondeur (mm)	Superficie de exposición Display area Surface d'exposition (m²)	Superficie total de exposición (TDA) Total display area (TDA) Surface totale de l'exposition (TDA) (m²)		Cámara VE Storage VE Stockage VE (m³)	Puertas Doors Portes (Uds)	Potencia frig. Frig. Power Puissance frig. (W)	Consumo Consumption Consommation (W)	Refrigerante Coolant Réfrigérant
					(C)	(RR)					
VE-9-AN90	1405	1230	1405	1,04	0,69	0,87	-	0	572	858	R-290
VE-9-AP90	1520	1230	1520	1,47	1,31	1,56	-	0	781	968	R-290
VE-9N-AN45	1105	1230	1030	0,52	-	-	-	0	-	10	
VE-9N-AP45	1115	1230	1125	0,73	-	-	-	0	-	10	
VE-9-RN90	1410	1230	1410	1,24	0,84	1,07	-	0	572	858	R-290
VE-9-RP90	1385	1230	1385	1,60	1,41	1,67	-	0	572	858	R-290
MCVE-9-8	800	910	940	0,67							
MCVE-9-12	1200	910	940	1,03							

Características técnicas y constructivas sujetas a variación sin previo aviso / We reserve the right to change specifications without prior notice / Sujet technique et la conception de modifications sans préavis



4000K

3000K



CARACTERÍSTICAS TÉCNICAS

- Diseño especial para pastelería,
- Exterior e interior en chapa de acero plastificada
- Plano exposición y encimera en acero inox. AISI-304
- Bandejas plano de exposición lisas, con escalón sobre demanda
- Costados de 30 mm en ABS inyectado
- Perfilera en aluminio anodizado.
- Paragolpes en la parte delantera
- Cristal frontal templado, dos versiones curvo abatible y una cristal recto
- Estantes de cristal intermedios, no refrigerados
- Iluminación estándar: encimera superior, estante inferior y base frontal LED
- Aislamiento de poliuretano inyectado, densidad 40 Kg/m³, bajo GWP y cero efecto ODP
- Reserva refrigerada con puertas, hueco 440x270 (excepto modelo neutro)
- Evaporador estático, opcional ventilado
- Condensación ventilada y evaporación automática de serie
- Control electrónico de temperatura
- Descarche automático, opcional eléctrico
- Clase climática 4 (30°C 55%HR) régimen M1 según UNE-EN ISO 23953-2
- Chasis en acero acabado epoxi
- Tensión de trabajo monofásica 220V 50Hz

TECHNICAL DATA

- Design focused for bakery,
- Interior and exterior finish in plastic coated steel
- Display area and counter in stainless steel AISI-304
- Smooth deck for display area, stepped at on demand
- Sides available in ABS injected, 30 mm thickness
- Anodised aluminium profiles
- Front rubber bumper
- Toughened glass, three versions curved hinges forward
- Glass shelves non refrigerated
- Standard lighting: top worktop, lower shelf and front base LED
- 40 Kg/m³ density polyurethane insulation, low GWP and zero ODP effect
- Refrigerated under storage with doors 440x270 free (except neutral model)
- Static evaporator, ventilated as optional
- Ventilated condensation and automatic defrost evaporation as standard
- Electronic temperature controller
- Automatic defrost, electric as optional
- Climatic class 4 (30 ° C 55% Hr) regime M1 according to UNE-EN ISO 23953-2
- Working voltage single phase 220V 50Hz
- Chassis in epoxy finished steel

CARACTÉRISTIQUES TECHNIQUES

- La conception spéciale pour la pâtisserie
- Extérieur et intérieur en tôle d'acier laminé
- Niveau d'exposition et de haut en acier inoxydable. AISI-304
- Niveau de plateaux d'exposition lisses, pas à pas le sur demande
- Côtés de 30 mm en ABS injecté
- Profils en aluminium anodisé.
- Sur le pare-chocs avant
- Façade en verre trempé, trois courbes versions de pliage et fixe le verre plat
- Étagères en verre intermédiaires, et non pas au réfrigérateur
- Éclairage standard: surface supérieure étagère du bas, et avant de la base LED
- Isolation en polyuréthane injecté, densité 40 kg/m³, faible GWP et ODP
- Zéro portes à effet de livres refroidis, creuse 440x270 (sauf modèle neutre)
- Evaporateur statique, ventilé en option
- Ventilé condensation, évaporation automatique de série
- Contrôle électronique de la température
- Dégivrage automatique, électrique en option
- Classe climatique 4 (30 ° C 55% Hr) régime M1 selon UNE-EN ISO 23953-2
- Tension de fonctionnement monophasé 220V 50Hz
- Châssis en acier fini époxy



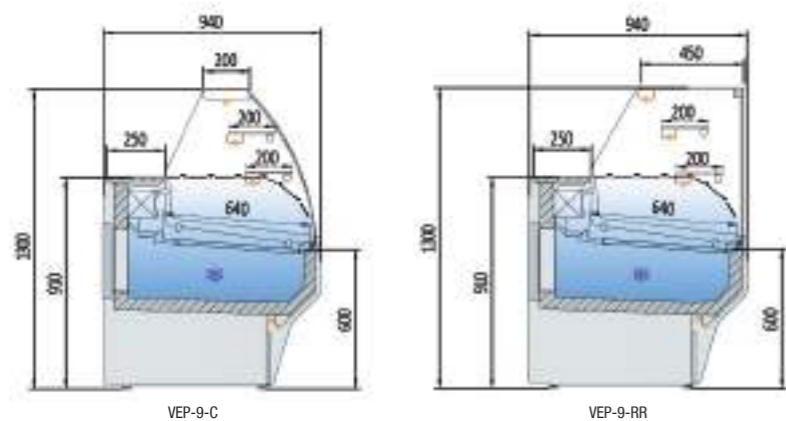

protector estornudos frontal (solo modelos RR, consultar)
front sneeze protector (RR models only, consult)
protection contre l'éternuement avant (modèles RR uniquement, consulter)

Estante de cristal no refrigerado
Glass shelf non refrigerated
Étagère en verre non refroidi

Ver características técnicas en página 33 / See technical data in page 33 / Voir caractéristiques techniques page 33

Modelo Model Modèle	Largo Length Longueur (mm)	Superficie de exposición Display area Surface d'exposition (m²)	Superficie total de exposición (TDA) Total display area (TDA) Surface totale de l'exposition (TDA) (m²)		Cámara VE Storage VE Stockage VE (lts.)	Puertas Doors Portes (Uds)	Potencia frig. Frig. Power Puissance frig. (W)	Consumo Nominal Nominal power Consommation nominale (W)	Refrigerante Coolant Réfrigérant
			(C)	(RR)					
VEP-9-10	1025	0,96	0,62	0,76	299	1	565	837	R-290
VEP-9-13	1265	1,20	0,78	0,95	376	2	572	901	R-290
VEP-9-15	1505	1,44	0,93	1,14	452	2	781	1023	R-290
VEP-9-20	1985	1,92	1,24	1,52	606	3	1098	1248	R-290
VEP-9-25	2465	2,40	1,55	1,90	759	4	1284	1318	R-290
VEP-9-30	2945	2,88	1,86	2,28	913	4	1284	1345	R-290

*Modelos en HFC, consultar precio / HFC Models, consult prices / Modèles HFC, consulter prix

230v 60Hz / 115v 60Hz, consultar - consult - consulter

PVP de opcionales incluidos en equipo, no como repuesto / PVP of options included in the equipment, not as a spare part / PVP d'options incluses dans l'équipement, pas en tant que pièce de rechange

Modelo Model Modèle	OPCIONES · OPTIONS · OPTIONS						
	1 decoración frontal / front decor / décoration frontal	2 Total decoración / Total decor / décoration total	Cierre Plexi Plexi slide Kit vitrage plexi	Plano de exposición hermético Plane of airtight exhibition Avion de exposition hermétique	Iluminación led extra Extra led lighting Éclairage Led extra	Neutra Neutral Neutre	Pre Instalación Remote Unit Groupe à distance
VEP-9-10	140 €	460 €	118 €	75 €	57 €	-410 €	-120 €
VEP-9-13	150 €	471 €	173 €	86 €	78 €	-460 €	-135 €
VEP-9-15	164 €	481 €	201 €	100 €	93 €	-510 €	-145 €
VEP-9-20	174 €	489 €	252 €	125 €	112 €	-615 €	-180 €
VEP-9-25	184 €	495 €	335 €	174 €	148 €	-870 €	-205 €
VEP-9-30	194 €	502 €	397 €	205 €	160 €	-995 €	-255 €

Características técnicas y constructivas sujetas a variación sin previo aviso. / We reserve the right to change specifications without prior notice. / Sujet technique et la conception de modifications sans préavis.

□□□□□ 4000K
●●●●● 3000K



VEP-9-15-C



VEP-9-20-RR

Laterales incluidos en PVP / Sides included in PVP / Latéraux inclus dans PVP

VEP-9-10-RR 2.753 €	VEP-9-13-RR 2.876 €	VEP-9-15-RR 3.121 €	VEP-9-20-RR 3.802 €	VEP-9-25-RR 4.436 €	VEP-9-30-RR 5.613 €
VEP-9-10-RR-TF 2.834 €	VEP-9-13-RR-TF 3.039 €	VEP-9-15-RR-TF 3.346 €	VEP-9-20-RR-TF 3.918 €	VEP-9-25-RR-TF 4.579 €	VEP-9-30-RR-TF 5.978 €
VEP-9-10-C 2.753 €	VEP-9-13-C 2.876 €	VEP-9-15-C 3.121 €	VEP-9-20-C 3.802 €	VEP-9-25-C 4.436 €	VEP-9-30-C 5.613 €
VEP-9-10-C-TF 2.834 €	VEP-9-13-C-TF 3.039 €	VEP-9-15-C-TF 3.346 €	VEP-9-20-C-TF 3.918 €	VEP-9-25-C-TF 4.579 €	VEP-9-30-C-TF 5.978 €



Laterales incluidos en PVP / Sides included in PVP / Latéraux inclus dans PVP

Ver características técnicas en página 33 / See technical data in page 33 / Voir caractéristiques techniques page 33

CARACTERÍSTICAS TÉCNICAS ÁNGULOS REFRIGERADOS

- Sistema de evaporación ventilado
- Modelos AP45 y AN45 neutros
- **C:** Cristal curvo
- **RR:** Cristal doble recto
- Mismo precio para cristales **C** y **RR**

REFRIGERATED ANGLE TECHNICAL DATA

- Ventilated evaporation system
- Neutral models AP45 y AN45
- **C:** Curved glass
- **RR:** Double flat glass
- Same price for glass **C** and **RR**

CARACTÉRISTIQUES TECHNIQUES DES ANGLES RÉFRIGÉRÉS

- Système d'évaporation ventilé
- Modèles AP45 y AN45 neutres
- **C:** Vitre bombée
- **RR:** Vitre double droit
- Même prix pour le verre **C** et **RR**

CARACTERÍSTICAS TÉCNICAS MUEBLES CAJAS

- Todos los modelos con cajón incorporado, estantes y enchufe
- Modelo MCVE-DIS frontal adaptado a discapacitados
- Modelo MCVE frontal recto

CASH NEUTRAL COUNTER DATA

- All models with built-in drawer, shelves and plug
- Front MCVE-DIS model adapted for the disabled
- Straight front MCVE model

CARACTÉRISTIQUES TECHNIQUES DES MEUBLE CAISSE

- Tous les modèles avec tiroir intégré, étagères et prise
- Modèle avant MCVE-DIS adapté aux handicapés
- Modèle MCVE à façade droite

ÁNGULOS NEGATIVOS / NEGATIVE ANGLES / NÉGATIF ANGLES

VEP-9-RN90 6.053 €	VEP-9-AN90 6.053 €	VEP-9N-AN45 4.318 €

ÁNGULOS POSITIVOS / POSITIVE ANGLES / POSITIF ANGLES

VEP-9-RP90 6.039 €	VEP-9-AP90 6.039 €	VEP-9N-AP45 4.279 €

230v 60Hz / 115v 60Hz. consultar - consult - consulter

*Modelos en HFC, consultar precio / HFC Models, consult prices / Modèles HFC, consulter prix

PVP de opcionales incluidos en equipo, no como repuesto / PVP of options included in the equipment, not as a spare part / PVP d'options incluses dans l'équipement, pas en tant que pièce de rechange

OPCIONES · OPTIONS · OPTIONS

Modelo / Model / Modèle	1 decoración frontal / front decor / décoration frontal	2 Total decoración / Total decor / décoration total	Cierre Plexi / Plexi slide / Kit vitrage coulissant plexi	Iluminación led / led lighting / Éclairage Led blanc
VEP-9-AP90	156 €	502 €	271 €	93 €
VEP-9-RP90	156 €	502 €	271 €	93 €
VEP-9-AN90	156 €	502 €	271 €	93 €
VEP-9-RN90	156 €	502 €	271 €	93 €
VEP-9-AP45	156 €	502 €	118 €	93 €
VEP-9-AN45	156 €	502 €	118 €	93 €

DETALLE FRONTAL / FRONT DETAIL / DÉTAIL AVANT



DETALLE FRONTAL / FRONT DETAIL / DÉTAIL AVANT

Modelo / Model / Modèle	Total decoración / Total decor / Décoration total
MCVE-9-8-DIS	460 €
MCVE-9-8	460 €
MCVE-9-12-DIS	471 €
MCVE-9-12	471 €

MUEBLES CAJA NEUTROS / CASH NEUTRAL COUNTER / MEUBLE CAISSE NEUTRE

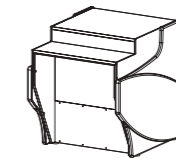

MCVE-9-8-DIS	1.261 €
MCVE-9-8	1.261 €

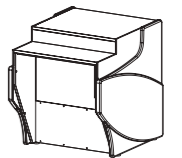

MCVE-9-12-DIS	1.314 €
MCVE-9-12	1.314 €

Modelo / Model / Modèle	Largo / Length / Longueur (mm)	Alto / Height / Hauteur (mm)	Fondo / Depth / Profondeur (mm)	Superficie de exposición / Display area / Surface d'exposition (m²)	Superficie total de exposición (TDA) / Total display area (TDA) / Surface totale de l'exposition (TDA) (m²)		Cámara VE / Storage VE / Stockage VE (m³)	Puertas / Doors / Portes (Uds)	Potencia frig. / Frig. Power / Puissance frig. (W)	Consumo / Consumption / Consommation (W)	Refrigerante / Coolant / Réfrigérant
					(C)	(RR)					
VEP-9-AN90	1405	1230	1405	1,04	0,69	0,87	-	0	572	858	R-290
VEP-9-AP90	1520	1230	1520	1,47	1,31	1,56	-	0	781	968	R-290
VEP-9N-AN45	1105	1230	1030	0,52	-	-	-	0	-	10	
VEP-9N-AP45	1115	1230	1125	0,73	-	-	-	0	-	10	
VEP-9-RN90	1410	1230	1410	1,24	0,84	1,07	-	0	572	858	R-290
VEP-9-RP90	1385	1230	1385	1,60	1,41	1,67	-	0	572	858	R-290
MCVE-9-8	800	910	940	0,67							
MCVE-9-12	1200	910	940	1,03							



CARACTERÍSTICAS TÉCNICAS

- Exterior e interior en chapa de acero plastificada
- Plano exposición y encimera en acero inox. AISI-304
- Bandejas plano de exposición lisas, con escalón sobre demanda
- Costados de 30 mm en ABS inyectado
- Perfilera en aluminio anodizado.
- Cristal frontal templado y abatible, dos versiones disponibles
- Estante de cristal intermedio, no refrigerado
- Iluminación estándar LED: encimera superior, estante y base frontal
- Aislamiento de poliuretano inyectado, densidad 40 Kg/m³, bajo GWP y cero efecto ODP
- Reserva refrigerada con puertas, hueco 440x270 (excepto modelo neutro y modelo sin reserva)
- Evaporador estático o ventilado
- Condensación ventilada y evaporación automática de serie
- Control electrónico de temperatura
- Descarche automático, opcional eléctrico
- Clase climática 4 (30 °C 55% Hr) régimen M1 según UNE-EN ISO 23953-2
- Chasis en acero acabado epoxi
- Tensión de trabajo monofásica 220V 50Hz

TECHNICAL DATA

- Interior and exterior finish in plastic coated steel
- Display area and counter in stainless steel AISI-304
- Smooth deck for display area, stepped at on demand
- Sides available in ABS injected, 30 mm thickness
- Anodised aluminium profiles
- Toughened curved glass hinges forward, two versions available
- Glass shelf non refrigerated
- Standard lighting LED: top worktop, shelf and low
- 40 Kg/m³ density polyurethane insulation, low GWP and zero ODP effect
- Refrigerated under storage with doors 440x270 free (except neutral model and model without reservation)
- Static or ventilated evaporator
- Ventilated condensation and automatic defrost evaporation as standard
- Electronic temperature control
- Automatic defrost, electric as optional
- Climatic class 4 (30 °C 55% Hr) regime M1 according to UNE-EN ISO 23953-2
- Working voltage single phase 220V 50Hz
- Chassis in epoxy finished steel

CARACTÉRISTIQUES TECHNIQUES

- Extérieur et intérieur en acier plastifié.
- Surface d'exposition et plan de travail en inox. AISI-304
- Bacs planes à surface d'exposition, possibilité double niveau sur demande
- Côtés en ABS thermoformé, épaisseur 30 mm.
- Profilés en aluminium anodisé
- Vitre droite ou bombée sécurit rabattable
- Etagère en verre non réfrigérée
- Lumière standard en partie haute LED, étageré et front bas
- Isolation en polyuréthane injecté sans CFC, densité 40Kg/m³
- Stockage réfrigéré, espace 440x270 (sauf modèle neutre et le modèle sans réserve)
- Evaporateur statique et ventilé
- Condensation ventilé, évaporation automatique en standard
- Contrôle électronique de la température
- Dégivrage automatique, électrique en option
- Classe climatique 4 (30 °C 55% Hr) régime M1 selon UNE-EN ISO 23953-2
- Tension de fonctionnement monophasé 220V 50Hz
- Châssis en acier fini époxy



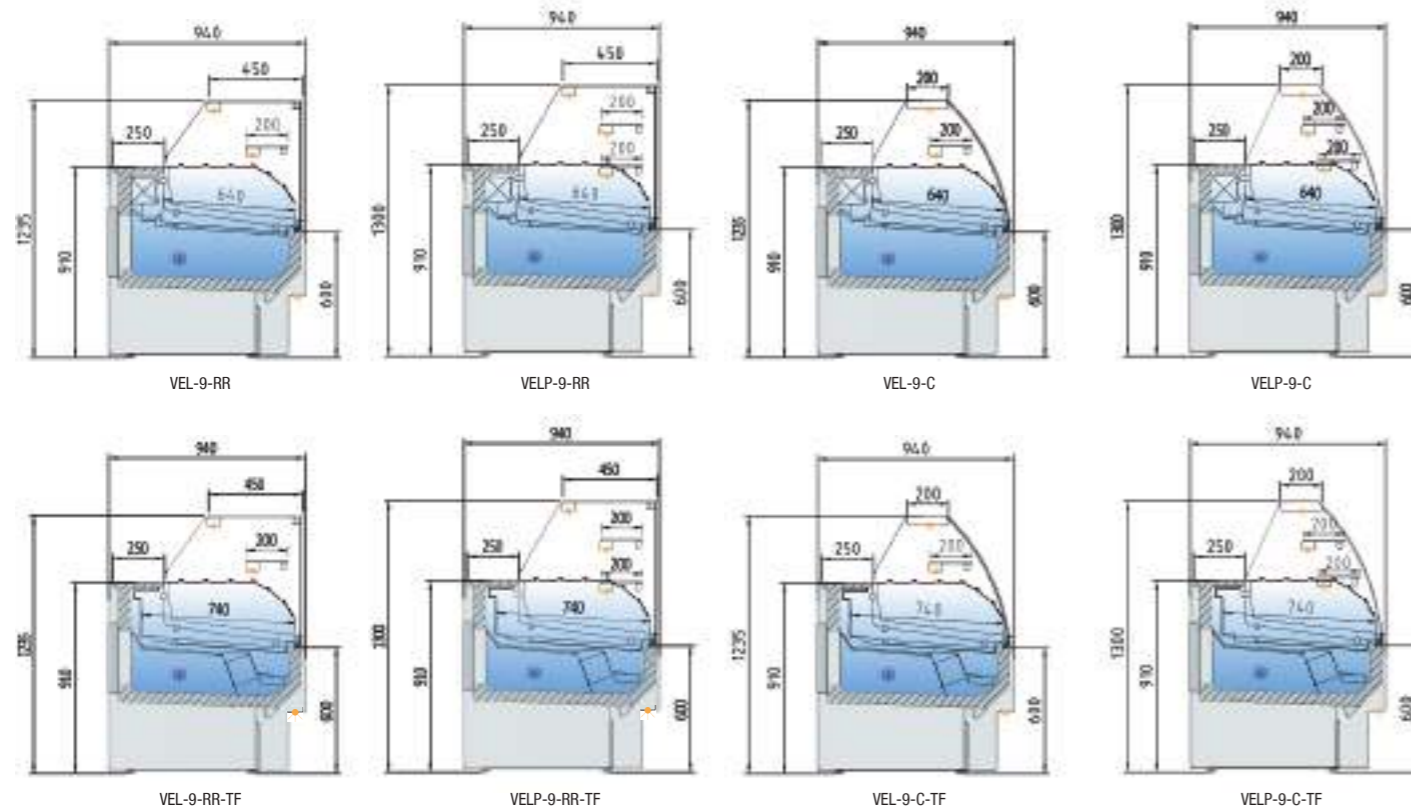

4000K RED FRESH



VEL-9-20-RR-TF



VELP-9-15-C

Ver características técnicas en página 38 / See technical data in page 38 / Voir caractéristiques techniques page 38

Modelo Model Modèle	Largo Length Longueur (mm)	Superficie de exposición Display area Surface d'exposition (m²)	Superficie total de exposición (TDA) Total display area (TDA) Surface totale de l'exposition (TDA) (m²)		Cámara VE Storage VE Stockage VE (lts.)	Puertas Doors Portes (Uds)	Potencia frig. Frig. Power Puissance frig. (W)	Consumo Nominal Nominal power Consommation nominale (W)	Refrigerante Coolant Réfrigérant
			(VEL)	(VELP)					
VEL-9-10	1025	0,86	0,76	0,76	242	1	565	851	R-290
VEL-9-13	1265	1,08	0,95	0,95	304	2	572	912	R-290
VEL-9-15	1505	1,29	1,14	1,14	366	2	781	1046	R-290
VEL-9-20	1985	1,72	1,52	1,52	491	3	1098	1290	R-290
VEL-9-25	2465	2,15	1,90	1,90	615	4	1284	1354	R-290
VEL-9-30	2945	2,58	2,28	2,28	739	4	1284	1378	R-290

230v 60Hz / 115v 60Hz. consultar - consult - consulter

*Modelos en HFC, consultar precio / HFC Models, consult prices / Modèles HFC, consulter prix

PVP de opcionales incluidos en equipo, no como repuesto / PVP of options included in the equipment, not as a spare part / PVP d'options incluses dans l'équipement, pas en tant que pièce de rechange

Modelo Model Modèle	OPCIONES · OPTIONS · OPTIONS		Cierre Plexi Plexi slide Doors Kit vitrage arrière coulissant plexi	Iluminación led extra Extra led lighting Eclairage led extra	Cierre cortina Night blind Rideau nocturne	Neutra Neutral Neutre	Pre Instalación Remote Unit Groupe à distance
	1 decoración frontal / front decor / décoration frontal	2 Total decoración / Total decor / décoration total					
VEL / VELP-9-10	140 €	460 €	118 €	57 €	175 €	-410 €	-120 €
VEL / VELP-9-13	150 €	471 €	173 €	78 €	242 €	-460 €	-135 €
VEL / VELP-9-15	164 €	481 €	201 €	93 €	292 €	-510 €	-145 €
VEL / VELP-9-20	174 €	489 €	252 €	112 €	321 €	-615 €	-180 €
VEL / VELP-9-25	184 €	495 €	335 €	148 €	378 €	-870 €	-205 €
VEL / VELP-9-30	194 €	502 €	397 €	160 €	581 €	-995 €	-255 €

Características técnicas y constructivas sujetas a variación sin previo aviso. / We reserve the right to change specifications without prior notice. / Sujet technique et la conception de modifications sans préavis.

Mismo precio cristal C y RR / Same price glass C and RR / Même prix verre C et RR

Laterales incluidos en PVP / Sides included in PVP / Latéraux inclus dans PVP

VEL-9-10	2.371 €	VEL-9-13	2.615 €	VEL-9-15	2.837 €	VEL-9-20	3.455 €	VEL-9-25	4.034 €	VEL-9-30	4.829 €
VEL-9-10-TF	2.452 €	VEL-9-13-TF	2.777 €	VEL-9-15-TF	3.062 €	VEL-9-20-TF	3.570 €	VEL-9-25-TF	4.178 €	VEL-9-30-TF	5.194 €
VELP-9-10	2.753 €	VELP-9-13	2.876 €	VELP-9-15	3.121 €	VELP-9-20	3.802 €	VELP-9-25	4.436 €	VELP-9-30	5.613 €
VELP-9-10-TF	2.834 €	VELP-9-13-TF	3.039 €	VELP-9-15-TF	3.346 €	VELP-9-20-TF	3.918 €	VELP-9-25-TF	4.579 €	VELP-9-30-TF	5.978 €

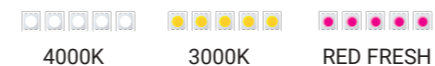

CARACTERÍSTICAS TÉCNICAS

- Exterior e interior en chapa de acero plastificada
- Plano exposición y encimera en acero inox. AISI-304
- Bandejas plano de exposición lisas, con escalón sobre demanda
- Costados de 30 mm en ABS inyectado,
- Perfilera en aluminio anodizado.
- Cristal frontal templado, tres versiones disponibles
- Estante de cristal intermedio, no refrigerado
- Aislamiento de poliuretano inyectado, densidad 40 Kg/m³, bajo GWP y cero efecto ODP
- Reserva refrigerada con puertas, hueco 440x270 (excepto modelo neutro y modelo sin reserva)
- Evaporador estático, opcional ventilado
- Condensación ventilada y evaporación automática de serie
- Control electrónico de temperatura
- Descarche automático, opcional eléctrico
- Clase climática 4 (30 °C 55% Hr) régimen M1 según UNE-EN ISO 23953-2
- Chasis en acero acabado epoxi
- Tensión de trabajo monofásica 220V 50Hz

TECHNICAL DATA

- Interior and exterior finish in plastic coated steel
- Display area and counter in stainless steel AISI-304
- Smooth deck for display area, stepped at on demand
- Sides in ABS injected, 30 mm thickness
- Anodised aluminium profiles
- Toughened glass, three versions available
- Glass shelf non refrigerated
- 40 Kg/m³ density polyurethane insulation, low GWP and zero ODP effect
- Refrigerated under storage with doors 440x270 free (except neutral model and model without reservation)
- Static evaporator, ventilated as optional
- Ventilated condensation and automatic defrost evaporation as standard
- Electronic temperature controller
- Automatic defrost, electric as optional
- Climatic class 4 (30 °C 55% Hr) regime M1 according to UNE-EN ISO 23953-2
- Working voltage single phase 220V 50Hz
- Chassis in epoxy finished steel

CARACTÉRISTIQUES TECHNIQUES

- Extérieur et intérieur en tôle d'acier plastifié.
- Plan d'exposition et plan de travail en acier inoxydable AISI 304
- Plateaux d'exposition plats et lisses, ou à échelon pour sur demande
- Côtés de 30mm en polystyrène injecté
- Profils en aluminium anodisé
- Vitrine frontale en verre trempé, trois versions disponibles.
- Étagère intermédiaire en verre, non réfrigérée
- Isolation en polyuréthane injecté, densité de 40 Kg / m³, faible GWP et aucun effet ODP.
- Réserve réfrigérée avec portes, espace de 440x270 (sauf modèle neutre et le modèle sans réserve)
- Évaporateur statique, sur option: évaporateur ventilé.
- Condensation ventilée, évaporation automatique de série.
- Contrôle électronique de température
- Dégivrage automatique-sur option électrique
- Classe climatique 4 (30 ° C 55% Hr) régime M1 selon UNE-EN ISO 23953-2
- Tension de fonctionnement monophasé 220V 50Hz
- Châssis en acier fini époxy



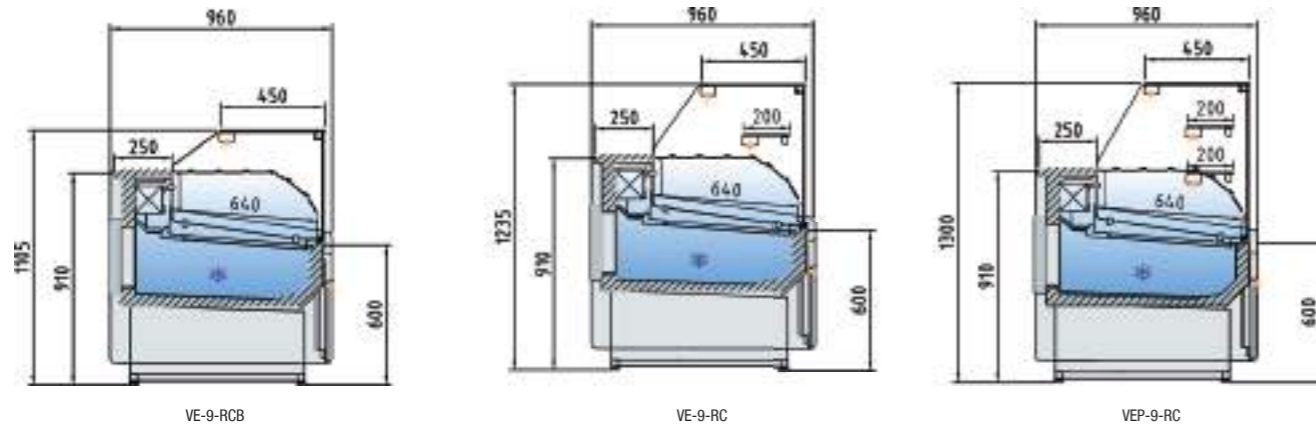

4000K 3000K RED FRESH



protector estornudos frontal (solo modelos RR, consultar)
front sneeze protector (RR models only, consult)
protection contre l'éternuement avant (modèles RR uniquement, consulter)



Franja superior inox
Stainless steel upper strip
Bande supérieure en acier inoxydable

Franja frontal decorativa (Carta colores pag. 16)
Decorative front stripe (Color chart page 16)
Bande décorative devant (Nuancier page 16)

Base inferior color RAL 7024 en todas las opciones
Lower base color RAL 7024 (in all options)
Couleur de base inférieure RAL 7024 (dans toutes les options)

VE-9-20-RC



VE-9-20-RCB

Ver características técnicas en página 42 / See technical data in page 42 / Voir caractéristiques techniques page 42

Modelo Model Modèle	Largo Length Longueur (mm)	Superficie de exposición Display area Surface d'exposition (m²)	Superficie total de exposición (TDA) Total display area (TDA) Surface totale de l'exposition (TDA) (m²)			Cámara VE Storage VE Stockage VE (m³)	Puertas Doors Portes (Uds)	Potencia frig. Frig. Power Puissance frig. (W)	Consumo Nominal Nominal power Consommation nominale (W)	Refrigerante Coolant Réfrigérant
			(RCB)	(RC)	(P-RC)					
VE-9-10-RC	1025	0,77	0,76	0,76	0,76	299	1	565	830	R-290
VE-9-13-RC	1265	0,96	0,95	0,95	0,95	376	2	572	891	R-290
VE-9-15-RC	1505	1,15	1,14	1,14	1,14	452	2	781	1011	R-290
VE-9-20-RC	1985	1,54	1,52	1,52	1,52	606	3	1098	1234	R-290
VE-9-25-RC	2465	1,92	1,90	1,90	1,90	759	4	1284	1298	R-290
VE-9-30-RC	2945	2,30	2,28	2,28	2,28	913	4	1284	1322	R-290

230v 60Hz / 115v 60Hz. consultar - consult - consulter

*Modelos en HFC, consultar precio / HFC Models, consult prices / Modèles HFC, consulter prix

PVP de opcionales incluidos en equipo, no como repuesto / PVP of options included in the equipment, not as a spare part / PVP d'options incluses dans l'équipement, pas en tant que pièce de rechange

Modelo Model Modèle	OPCIONES · OPTIONS · OPTIONS		Cierre Plexi Plexi slide Doors Kit vitrage arrière coulissant plexi	Iluminación led extra Extra led lighting Eclairage led extra	Cierre cortina Night blind Rideau nocturne	Neutra Neutral Neutre	Pre Instalación Remote Unit Groupe à distance
	1 decoración frontal / front decor / décoration frontal	2 Total decoración / Total decor / décoration total					
VE-9-10-RC	140 €	460 €	118 €	57 €	175 €	-410 €	-120 €
VE-9-13-RC	150 €	471 €	173 €	78 €	242 €	-460 €	-135 €
VE-9-15-RC	164 €	481 €	201 €	93 €	292 €	-510 €	-145 €
VE-9-20-RC	174 €	489 €	252 €	112 €	321 €	-615 €	-180 €
VE-9-25-RC	184 €	495 €	335 €	148 €	378 €	-870 €	-205 €
VE-9-30-RC	194 €	502 €	397 €	160 €	581 €	-995 €	-255 €

Laterales incluidos en PVP / Sides included in PVP / Latéraux inclus dans PVP

VE-9-10-RCB 2.747 €	VE-9-13-RCB 3.030 €	VE-9-15-RCB 3.310 €	VE-9-20-RCB 4.003 €	VE-9-25-RCB 4.675 €	VE-9-30-RCB 5.596 €
VE-9-10-RC 2.832 €	VE-9-13-RC 3.124 €	VE-9-15-RC 3.412 €	VE-9-20-RC 4.127 €	VE-9-25-RC 4.820 €	VE-9-30-RC 5.770 €
VEP-9-10-RC 3.114 €	VEP-9-13-RC 3.437 €	VEP-9-15-RC 3.754 €	VEP-9-20-RC 4.543 €	VEP-9-25-RC 5.300 €	VEP-9-30-RC 6.349 €

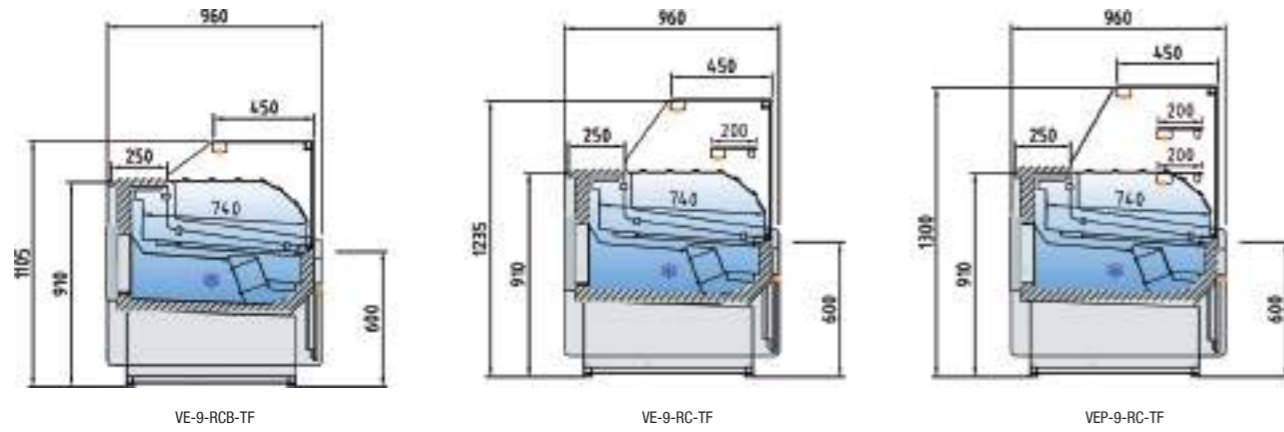

4000K 3000K RED FRESH



détalle separador de genero
détail separator genre
détail séparateur de genre



protector estornudos frontal (solo modelos RR, consultar)
front sneeze protector (RR models only, consult)
protection contre l'éternement avant (modèles RR uniquement, consulter)

Ver características técnicas en página 42 / See technical data in page 42 / Voir caractéristiques techniques page 42

Modelo Model Modèle	Largo Length Longueur (mm)	Superficie de exposición Display area Surface d'exposition (m²)	Superficie total de exposición (TDA) Total display area (TDA) Surface totale de l'exposition (TDA) (m²)			Cámara VE Storage VE Stockage VE (m³)	Puertas Doors Portes (Uds)	Potencia frig. Frig. Power Puissance frig. (W)	Consumo Nominal Nominal power Consommation nominale (W)	Refrigerante Coolant Réfrigérant
			(RCB)	(RC)	(P-RC)					
VE-9-10-RC-TF	1025	0,86	0,76	0,76	0,76	242	1	565	851	R-290
VE-9-13-RC-TF	1265	1,08	0,95	0,95	0,95	304	2	572	912	R-290
VE-9-15-RC-TF	1505	1,29	1,14	1,14	1,14	366	2	781	1046	R-290
VE-9-20-RC-TF	1985	1,72	1,52	1,52	1,52	491	3	1098	1290	R-290
VE-9-25-RC-TF	2465	2,15	1,90	1,90	1,90	615	4	1284	1354	R-290
VE-9-30-RC-TF	2945	2,58	2,28	2,28	2,28	739	4	1284	1378	R-290

230v 60Hz / 115v 60Hz. consultar - consult - consulter

*Modelos en HFC, consultar precio / HFC Models, consult prices / Modèles HFC, consulter prix

PVP de opcionales incluidos en equipo, no como repuesto / PVP of options included in the equipment, not as a spare part / PVP d'options incluses dans l'équipement, pas en tant que pièce de rechange

OPCIONES · OPTIONS · OPTIONS

Modelo Model Modèle	1 decoración frontal / front decor / décoration frontal		2 Total decoración / Total decor / décoration total		Cierre Plexi Plexi slide Kit vitrage plexi	Cierre cortina Night blind Rideau nocturne	Iluminación led extra Extra led lighting Éclairage Led extra	Pre Instalación Remote Unit Groupe à distance
VE-9-10-RC-TF	140 €		460 €		118 €	175 €	57 €	-120 €
VE-9-13-RC-TF	150 €		471 €		173 €	242 €	78 €	-135 €
VE-9-15-RC-TF	164 €		481 €		201 €	292 €	93 €	-145 €
VE-9-20-RC-TF	174 €		489 €		252 €	321 €	112 €	-180 €
VE-9-25-RC-TF	184 €		495 €		335 €	378 €	148 €	-205 €
VE-9-30-RC-TF	194 €		502 €		397 €	581 €	160 €	-255 €

Características técnicas y constructivas sujetas a variación sin previo aviso. / We reserve the right to change specifications without prior notice. / Sujet technique et la conception de modifications sans préavis.



VE-9-15-RC-TF

Franja superior inox
Stainless steel upper strip
Bande supérieure en acier inoxydable

Franja frontal decorativa (Carta colores pag. 16)
Decorative front stripe (Color chart page 16)
Bande décorative devant (Nuancier page 16)

Base inferior color RAL 7024 en todas las opciones
Lower base color RAL 7024 (in all options)
Couleur de base inférieure RAL 7024 (dans toutes les options)

Laterales incluidos en PVP / Sides included in PVP / Latéraux inclus dans PVP

VE-9-10-RCB-TF 2.866 €	VE-9-13-RCB-TF 3.241 €	VE-9-15-RCB-TF 3.634 €	VE-9-20-RCB-TF 4.296 €	VE-9-25-RCB-TF 4.866 €	VE-9-30-RCB-TF 5.759 €
VE-9-10-RC-TF 2.983 €	VE-9-13-RC-TF 3.371 €	VE-9-15-RC-TF 3.741 €	VE-9-20-RC-TF 4.316 €	VE-9-25-RC-TF 4.971 €	VE-9-30-RC-TF 5.993 €
VEP-9-10-RC-TF 3.281 €	VEP-9-13-RC-TF 3.708 €	VEP-9-15-RC-TF 4.115 €	VEP-9-20-RC-TF 4.747 €	VEP-9-25-RC-TF 5.468 €	VEP-9-30-RC-TF 6.593 €

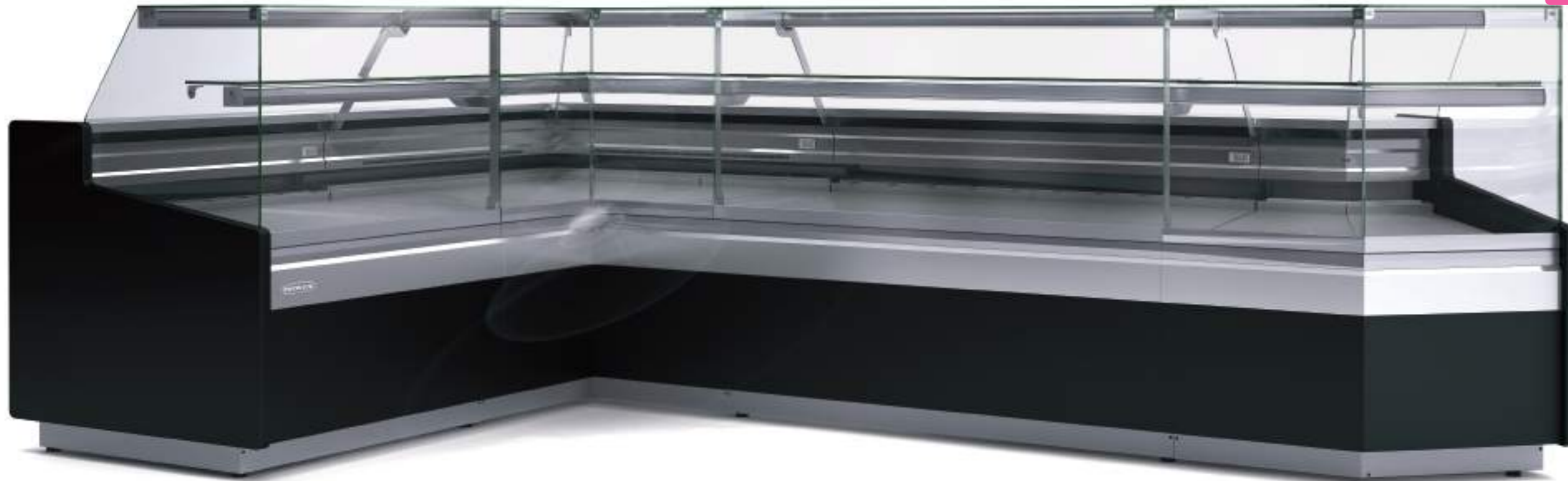

Mueble caja torre MCT-70-RC
Cash neutral counter tower MCT-70-RC
Meuble caisse tour MCT-70-RC

Laterales incluidos en PVP / Sides included in PVP / Latéraux inclus dans PVP

Ver características técnicas en página 42 / See technical data in page 42 / Voir caractéristiques techniques page 42

CARACTERÍSTICAS TÉCNICAS ÁNGULOS REFRIGERADOS

- Sistema de evaporación ventilado
- Modelos AP45 y AN45 neutros
- RC: Cristal recto

REFRIGERATED ANGLE TECHNICAL DATA

- Ventilated evaporation system
- Neutral models AP45 y AN45
- RC: Flat glass

CARACTÉRISTIQUES TECHNIQUES DES ANGLES RÉFRIGÉRÉS

- Système d'évaporation ventilé
- Modèles AP45 y AN45 neutres
- RC: Vitre droit

CARACTERÍSTICAS TÉCNICAS MUEBLES CAJAS

- Todos los modelos con cajón incorporado, estantes y enchufe
- Modelo MCVE-DIS frontal adaptado a discapacitados
- Modelo MCVE frontal recto

CASH NEUTRAL COUNTER DATA

- All models with built-in drawer, shelves and plug
- Front MCVE-DIS model adapted for the disabled
- Straight front MCVE model

CARACTÉRISTIQUES TECHNIQUES DES MEUBLE CAISSE

- Tous les modèles avec tiroir intégré, étagères et prise
- Modèle avant MCVE-DIS adapté aux handicapés
- Modèle MCVE à façade droite

CARACTERÍSTICAS TÉCNICAS MUEBLES CAJAS MCT-70

- Exterior en madera MDF hidrofuga según color
- Interior en acero prepintado
- 4 Estantes de cristal regulables en inclinación
- De serie: Luz vertical led
- Gran visibilidad de producto, laterales y frontal acristalados
- Lacado según color RAL

CASH NEUTRAL COUNTER DATA MCT-70

- MDF wood exterior water leak according to color
- Prepainted steel interior
- 4 Glass shelves adjustable in inclination
- Standard: led vertical light
- High product visibility, side and front glazing
- Lacquered according to RAL color

CARACTÉRISTIQUES TECHNIQUES DES MEUBLE CAISSE MCT-70

- Bois extérieur MDF repoussant par couleur
- Prépeinte intérieur acier
- 4 tablettes en verre réglables en inclinaison
- Série: lumière verticale LED
- Grande visibilité du produit, côté frontal et vitrés
- Laqué selon RAL

ÁNGULOS NEGATIVOS / NEGATIVE ANGLES / NÉGATIF ANGLES

VE-9-RN90-RCB 5.677 €	VE-9-AN90-RCB 5.677 €	VE-9N-RN45-RCB 3.984 €
VE-9-RN90-RC 5.789 €	VE-9-AN90-RC 5.789 €	VE-9N-RN45-RC 4.108 €
VEP-9-RN90-RC 6.082 €	VEP-9-AN90-RC 6.082 €	VEP-9N-RN45-RC 4.279 €

ÁNGULOS POSITIVOS / POSITIVE ANGLES / POSITIF ANGLES

VE-9-RP90-RCB 5.662 €	VE-9-AP90-RCB 5.662 €	VE-9N-RP45-RCB 3.984 €
VE-9-RP90-RC 5.775 €	VE-9-AP90-RC 5.775 €	VE-9N-RP45-RC 4.108 €
VEP-9-RP90-RC 6.067 €	VEP-9-AP90-RC 6.067 €	VEP-9N-RP45-RC 4.279 €

*Modelos en HFC, consultar precio / HFC Models, consult prices / Modèles HFC, consulter prix
230v 60Hz / 115v 60Hz. consultar - consult - consulter

PVP de opcionales incluidos en equipo, no como repuesto / PVP of options included in the equipment, not as a spare part / PVP d'options incluses dans l'équipement, pas en tant que pièce de rechange

OPCIONES · OPTIONS · OPTIONS

Modelo	1 decoración frontal / front decor / décoration frontal	2 Total decoración / Total decor / décoration total	Cierre Plexi	Iluminación led
Model			Plexi slide	led lighting
Modèle			Kit vitrage coulissant plexi	Éclairage Led blanc
VE-9-AP90-RC	156 €	502 €	271 €	93 €
VE-9-RP90-RC	156 €	502 €	271 €	93 €
VE-9-AN90-RC	156 €	502 €	271 €	93 €
VE-9-RN90-RC	156 €	502 €	271 €	93 €
VE-9-AP45-RC	156 €	502 €	118 €	93 €
VE-9-AN45-RC	156 €	502 €	118 €	93 €

DETALLE FRONTAL / FRONT DETAIL
DÉTAIL AVANT



Modelo Model Modèle	Total decoración Total decor Décoration total
MCVE-9-8-DIS	460 €
MCVE-9-8	460 €
MCVE-9-12-DIS	471 €
MCVE-9-12	471 €

MUEBLES CAJA NEUTROS
CASH NEUTRAL COUNTER / MEUBLE CAISSE NEUTRE

	MCVE-9-8-RC-DIS 1.261 €		MCVE-9-12-RC-DIS 1.314 €		MCT-70-RC 1.996 €
	MCVE-9-8-RC 1.261 €		MCVE-9-12-RC 1.314 €		

Modelo Model Modèle	Largo Length Longueur (mm)	Alto Height Hauteur (mm)	Fondo Depth Profondeur (mm)	Superficie de exposición Display area Surface d'exposition (m²)	Superficie total de exposición (TDA) Total display area (TDA) Surface totale de l'exposition (TDA)		Cámara VE Storage VE Stockage VE (m³)	Puertas Doors Portes (Uds)	Potencia frig. Frig. Power Puissance frig. (W)	Consumo Consumption Consommation (W)	Refrigerante Coolant Réfrigérant
					(C)	(RR)					
VE/VEP-9-AN90-RCB/RC	1425	1230	1425	1,04	0,69	0,87	0		939	1122	R-290
VE/VEP-9-AP90-RCB/RC	1540	1230	1540	1,47	1,31	1,56	0		1084	1165	R-290
VE/VEP-9N-AN45-RCB/RC	1105	1230	1030	0,52	-	-	0	-		10	
VE/VEP-9N-AP45-RCB/RC	1115	1230	1125	0,73	-	-	0	-		10	
VE/VEP-9-RN90-RCB/RC	1430	1230	1430	1,24	0,84	1,07	0		926	961	R-290
VE/VEP-9-RP90-RCB/RC	1405	1230	1405	1,60	1,41	1,67	0		957	1004	R-290
MCVE-9-8-RC	800	910	960	0,67	-	-	-	-	-	-	
MCVE-9-12-RC	1200	910	960	1,03	-	-	-	-	-	-	
MCT-70-RC	700	1850	700	1,68	-	-	-	-	-	-	

Características técnicas y constructivas sujetas a variación sin previo aviso / We reserve the right to change specifications without prior notice / Sujet technique et la conception de modifications sans préavis

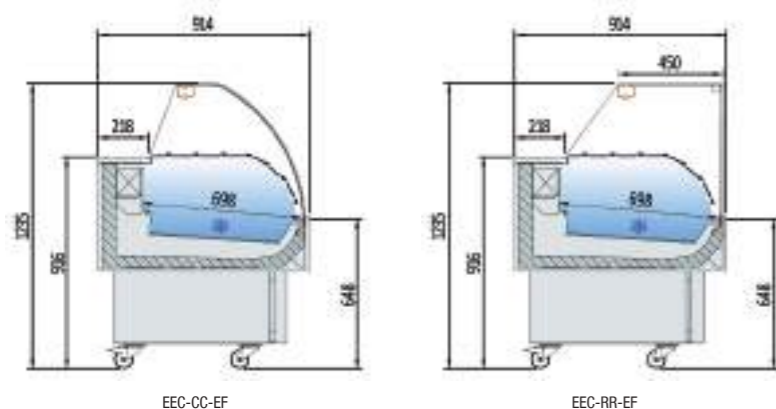

Detalle plano de exposicion
Display area detail
Up détail de l'exposition

SERIE VITRINA EXPOSITORA REFRIGERADA PESCADO O MARISCO EEC-EF
TROLEY REFRIGERATED DISPLAY FISH AND SHELLFISH EEC · ARMOIRE EEC CHARIOT POISSON ET CRUSTACÉS



4000K



EEC-130-CC-EF



EEC-150-RR-EF

Laterales incluidos en PVP / Sides included in PVP / Latéraux inclus dans PVP

CARACTERÍSTICAS TÉCNICAS EEC	TECHNICAL DATA EEC	CARACTÉRISTIQUES TECHNIQUES EEC
<ul style="list-style-type: none"> Exterior en acero inox AISI-304 Interior en acero inox AISI-304 Cristal frontal templado y abatible Bastidor en acero acabado epoxi, sobre ruedas, 2 de ellas con freno Perfilería de aluminio anodizado Unidad condensadora ventilada Aislamiento de poliuretano inyectado, densidad 40 Kg/m³, bajo GWP y cero efecto ODP Control digital de temperatura y descargas, eficiente en la gestión del consumo de energía Temperatura de trabajo a 25°C 60% HR ambiente, clase climática 3 EEC-EF evaporador estático + placa fría Cierre plexi de serie Iluminación LED superior 	<ul style="list-style-type: none"> AISI-304 stainless steel exterior AISI-304 stainless steel interior Toughened curved glass hinges forward Steel frame with epoxy finish, on wheels, 2 of them with brakes Anodized aluminium profiles Ventilated condenser unit 40 Kg/m³ density polyurethane insulation, low GWP and zero ODP effect Energy efficient digital controller of temperature and defrosts Operating temperature 25°C 60% HR ambient, climatic class 3 EEC-EF, static evaporator + cool plate Plexi slide doors as standard Top LED lighting 	<ul style="list-style-type: none"> Extérieur en acier inox AISI-304 Intérieur en acier inox AISI-304 Vitrine avant en verre trempé et rabatable Châssis acier finition époxy, sur roulettes dont 2 avec freins Profils en aluminium anodisé Unité de condensation ventilée Isolation à base de polyuréthane injecté, densité 40 kg/m³, faible GWP et aucun effet ODP. Le Contrôle digital de température ainsi que le dégivrage automatique œuvre à une meilleure gestion de la consommation énergétique. Température ambiante de travail à 25°C 60% HR, classe climatique 3 EEC-EF + évaporateur statique + plaque froide Fermer série plexi Illumination supérieure LED

Modelo Model Modèle	Largo Length Longueur (mm)	Superficie de exposición Display area Surface d'exposition (m ²)	Superficie total de exposición (TDA) Total display area (TDA) Surface totale de l'exposition (TDA) (m ²)	Potencia frig. Frig. Power Puissance frig. (W)	Consumo Nominal Nominal power Consommation nominale (W)	Refrigerante Coolant Réfrigérant
EEC-100-CC-EF	1035	0,55	0,76	565	815	R-290
EEC-130-CC-EF	1285	0,70	0,95	781	991	R-290
EEC-150-CC-EF	1505	0,84	1,13	949	1064	R-290
EEC-100-RR-EF	1035	0,55	0,76	565	815	R-290
EEC-130-RR-EF	1285	0,70	0,95	781	991	R-290
EEC-150-RR-EF	1505	0,84	1,13	949	1064	R-290

*Modelos en HFC, consultar precio / HFC Models, consult prices / Modèles HFC, consulter prix

230v 60Hz / 115v 60Hz. consultar - consult - consulter

PVP de opcionales incluidos en equipo, no como repuesto / PVP of options included in the equipment, not as a spare part / PVP d'options incluses dans l'équipement, pas en tant que pièce de rechange

Modelo Model Modèle	Cuerpo interior acero inox AISI-316 Inner structure stainless steel AISI-316 Corps intérieur acier AISI-316	Plano de exposición AISI-316 Exhibition plan/AISI-316 Project d'exposition AISI-316	Encimera acero inox AISI-316 Worktop stainless steel AISI-316 Plan de travail acier AISI-316
EEC-100	390 €	374 €	84 €
EEC-130	448 €	429 €	98 €
EEC-150	539 €	516 €	111 €

Características técnicas y constructivas sujetas a variación sin previo aviso. / We reserve the right to change specifications without prior notice. / Sujet technique et la conception de modifications sans préavis.

 EEC-100-RR-EF 2.830 €	 EEC-130-RR-EF 3.120 €	 EEC-150-RR-EF 3.274 €
 EEC-100-CC-EF 2.845 €	 EEC-130-CC-EF 3.280 €	 EEC-150-CC-EF 3.610 €

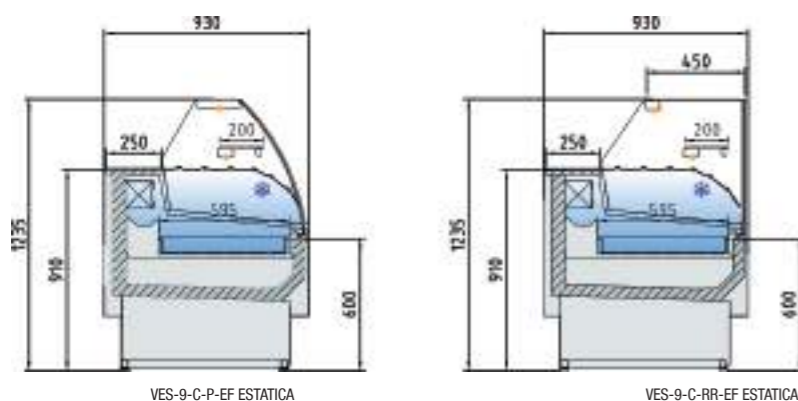

CARACTERÍSTICAS TÉCNICAS

- Exterior e interior en chapa de acero inoxidable
- Encimera de trabajo en acero inox AISI-316
- Plano de exposición hermético de altura 65mm, con desagüe canalizado al exterior, fabricado en acero inox AISI-316
- Costados en acero inox de 30mm.
- Perfilera en aluminio anodizado.
- Cristal frontal templado y abatible
- Estante de cristal intermedio, no refrigerado
- Iluminación estándar: encimera superior y estante LED
- Aislamiento de poliuretano inyectado, densidad 40 Kg/m³, bajo GWP y cero efecto ODP
- Evaporador estático con placa fría en el plano de exposición.
- Condensación ventilada
- Control electrónico de temperatura
- Descarche automático
- Temperatura de trabajo a 25°C 60% HR ambiente, clase climática 3
- Chasis en acero acabado epoxi
- Tensión de trabajo monofásica 220V 50Hz
- EF: Evaporador estático + placa fría

TECHNICAL DATA

- Exterior and interior in stainless steel sheet
- Worktop in stainless steel AISI-316
- Hermetic exposition 65mm height, with drainage channeled up to the outside, made of stainless steel AISI-316
- 30mm stainless steel sides.
- Anodised aluminium profiles
- Toughened curved glass hinges forward
- Glass shelf non refrigerated
- Standard lighting: top worktop and shelf LED
- 40 Kg/m³ density polyurethane insulation, low GWP and zero ODP effect
- Static evaporator and cold plate at the exposure level.
- Ventilated condensation
- Electronic temperature controller
- Automatic defrost
- Operating temperature 25°C 60% HR ambient, climatic class 3
- Working voltage single phase 220V 50Hz
- Chassis in epoxy finished steel
- EF: Static evaporator + cold plate

CARACTÉRISTIQUES TECHNIQUES

- Extérieur et intérieur en tôle d'acier inoxydable
- Plan de travail en acier inoxydable AISI-316
- Plan d'exposition hermétique (hauteur de 65mm) avec dégivrage dirigé vers l'extérieur, fabriqué en acier inoxydable AISI-316
- Côtés en acier inoxydable de 30 mm.
- Profils en aluminium anodisés
- Vitrine avant en verre trempé et rabatable
- étagère intermédiaire en verre, sans réfrigération LED
- Eclairage standard : Comptoir et plateau
- Isolation à base de polyuréthane injecté, densité 40 kg / m³, faible GWP et aucun effet ODP.
- Evaporateur statique avec plaque froide sur le plan d'exposition
- Condensation ventilée
- Contrôle électronique de température
- Dégivrage automatique
- Température ambiante de travail à 25°C 60% HR, classe climatique 3
- Tension de fonctionnement monophasé 220V 50Hz
- Châssis en acier fini époxy
- EF : Evaporateur statique + plaque froide



VES-9-20-RR-P-EF

Modelo Model Modèle	Largo Length Longueur (mm)	Superficie de exposición Display area Surface d'exposition (m ²)	Superficie total de exposición (TDA) Total display area (TDA) Surface totale de l'exposition (TDA) (m ²) (C)	Potencia frig. Frig. Power Puissance frig. (W)	Consumo Nominal Nominal power Consommation nominale (W)	Refrigerante Coolant Réfrigérant
VES-9-10-P-EF	1025	0,75	0,62	565	830	R-290
VES-9-13-P-EF	1265	0,94	0,78	949	1065	R-290
VES-9-15-P-EF	1505	1,13	0,93	949	1075	R-290
VES-9-20-P-EF	1985	1,51	1,24	1284	1269	R-290
VES-9-25-P-EF	2465	1,90	1,55	1284	1298	R-290

Modelos neutros y preinstalación / Neutral models and pre-installation / Modèles neutres et pré-installation consultar - consult - consulter

*Modelos en HFC, consultar precio / HFC Models, consult prices / Modèles HFC, consulter prix

230v 60Hz / 115v 60Hz. consultar - consult - consulter

PVP de opcionales incluidos en equipo, no como repuesto / PVP of options included in the equipment, not as a spare part / PVP d'options incluses dans l'équipement, pas en tant que pièce de rechange

OPCIONES · OPTIONS · OPTIONS

Modelo	Cierre Plexi	Cuerpo interior acero inox AISI-316	Cierre cortina	Iluminación led extra
Model	Plexi slide	Inner structure stainless steel AISI-316	Night blind	Extra led lighting
Modèle	Kit vitrage plexi	Corps intérieur acier AISI-316	Rideau nocturne	Éclairage Led extra
VES-9-10-P-EF	118 €	420 €	175 €	57 €
VES-9-13-P-EF	173 €	518 €	242 €	78 €
VES-9-15-P-EF	201 €	647 €	292 €	93 €
VES-9-20-P-EF	252 €	776 €	321 €	112 €
VES-9-25-P-EF	335 €	1.037 €	378 €	148 €

Mismo precio cristal C y RR / Same price glass C and RR / Même prix verre C et RR

Laterales incluidos en PVP / Sides included in PVP / Latéraux inclus dans PVP

VES-9-10-P-EF 3.259 €	VES-9-13-P-EF 3.531 €	VES-9-15-P-EF 3.908 €	VES-9-20-P-EF 4.723 €	VES-9-25-P-EF 6.032 €

Características técnicas y constructivas sujetas a variación sin previo aviso. / We reserve the right to change specifications without prior notice. / Sujet technique et la conception de modifications sans préavis.

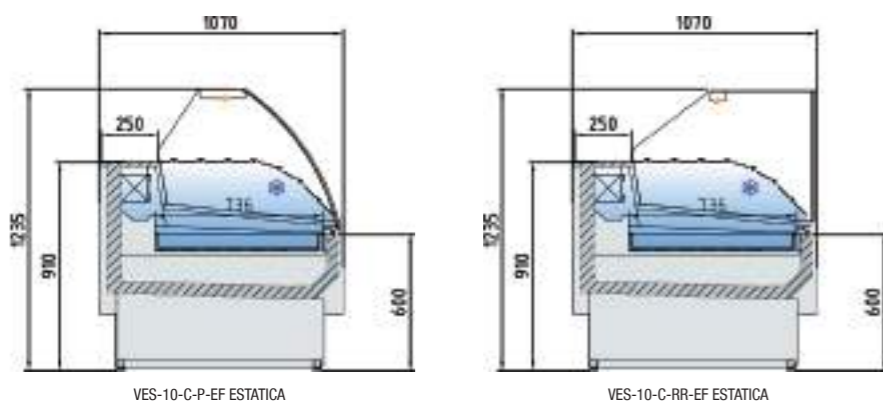

CARACTERÍSTICAS TÉCNICAS

- Exterior e interior en chapa de acero inoxidable
- Encimera de trabajo en acero inox AISI-316
- Plano de exposición hermético de altura 65mm, con desagüe canalizado al exterior, fabricado en acero inox AISI-316
- Costados en acero inox de 30mm.
- Perfilera en aluminio anodizado.
- Cristal frontal templado y abatible
- Iluminación estándar: encimera superior LED
- Aislamiento de poliuretano inyectado, densidad 40 Kg/m³, bajo GWP y cero efecto ODP
- Evaporador estático con placa fría en el plano de exposición.
- Condensación ventilada
- Control electrónico de temperatura
- Descarche automático
- Temperatura de trabajo a 25°C 60% HR ambiente, clase climática 3
- Chasis en acero acabado epoxi
- Tensión de trabajo monofásica 220V 50Hz
- EF: Evaporador estático + placa fría
- VES-10-P-EF-PR: Modelos preinstalación incorporan valvulería solenoide y expansión en R-449A, opción R-134a

TECHNICAL DATA

- Exterior and interior in stainless steel sheet
- Worktop in stainless steel AISI-316
- Hermetic exposition 65mm height, with drainage channeled up to the outside, made of stainless steel AISI-3016
- 30mm stainless steel sides.
- Anodised aluminium profiles
- Toughened curved glass hinges forward
- Standard lighting: top worktop LED
- 40 Kg/m³ density polyurethane insulation, low GWP and zero ODP effect
- Static evaporator and cold plate at the exposure level.
- Ventilated condensation
- Electronic temperature controller
- Automatic defrost
- Operating temperature 25°C 60% HR ambient, climatic class 3
- Working voltage single phase 220V 50Hz
- Chassis in epoxy finished steel
- EF: Static evaporator + cold plate
- VES-10-P-EF-PR: Pre-installation models incorporate solenoid valve and expansion in R-449A, option R-134a

CARACTÉRISTIQUES TECHNIQUES

- Extérieur et intérieur en tôle d'acier inoxydable
- Plan de travail en acier inoxydable AISI-316
- Plan d'exposition hermétique (hauteur de 65mm) avec dégivrage dirigé vers l'extérieur, fabriqué en acier inoxydable AISI-316
- Côtés en acier inoxydable de 30 mm.
- Profils en aluminium anodisés
- Vitrine avant en verre trempé et rabatable en verre, sans réfrigération LED
- Isolation à base de polyuréthane injecté, densité 40 kg / m³, faible GWP et aucun effet ODP.
- Evaporateur statique avec plaque froide sur le plan d'exposition
- Condensation ventilée
- Contrôle électronique de température
- Dégivrage automatique
- Température ambiante de travail à 25°C 60% HR, classe climatique 3
- Tension de fonctionnement monophasé 220V 50Hz
- Châssis en acier fini époxy
- EF : Evaporateur statique + plaque froide
- VES-10-P-EF-PR: Les modèles de pré-installation incorporent l'électrovanne et l'expansion R-449A en option R-134a



VES-10-20-RR-P-EF



VES-10-20-C-P-EF-PR

Modelo Model Modèle	Largo Length Longueur (mm)	Superficie de exposición Display area Surface d'exposition (m ²)	Superficie total de exposición (TDA) Total display area (TDA) Surface totale de l'exposition (TDA) (m ²) (C)	Potencia frig. Frig. Power Puissance frig. (W)	Consumo Nominal Nominal power Consommation nominale (W)	Refrigerante Coolant Réfrigérant
VES-10-10-P-EF	1025	0,75	0,62	565	830	R-290
VES-10-13-P-EF	1265	0,94	0,78	949	1065	R-290
VES-10-15-P-EF	1505	1,13	0,93	949	1075	R-290
VES-10-20-P-EF	1985	1,51	1,24	1284	1269	R-290
VES-10-25-P-EF	2465	1,90	1,55	1284	1298	R-290

Modelos neutros y preinstalación / Neutral models and pre-installation / Modèles neutres et pré-installation consulter - consult - consulter

*Modelos en HFC, consultar precio / HFC Models, consult prices / Modèles HFC, consulter prix

230v 60Hz / 115v 60Hz. consultar - consult - consulter

PVP de opcionales incluidos en equipo, no como repuesto / PVP of options included in the equipment, not as a spare part / PVP d'options incluses dans l'équipement, pas en tant que pièce de rechange

OPCIONES · OPTIONS · OPTIONS

Modelo Model Modèle	Cierre Plexi Plexi slide Kit vitrage plexi	Cierre cortina Night blind Rideau nocturne	Iluminación led extra Extra led lighting Éclairage Led extra
VES-10-10-P-EF	118 €	175 €	57 €
VES-10-13-P-EF	173 €	242 €	78 €
VES-10-15-P-EF	201 €	292 €	93 €
VES-10-20-P-EF	252 €	321 €	112 €
VES-10-25-P-EF	335 €	378 €	148 €

Mismo precio cristal C y RR / Same price glass C and RR / Même prix verre C et RR

Laterales incluidos en PVP / Sides included in PVP / Latéraux inclus dans PVP

VES-10-10-P-EF-PR 3.790 €	VES-10-13-P-EF-PR 3.995 €	VES-10-15-P-EF-PR 4.444 €	VES-10-20-P-EF-PR 5.293 €	VES-10-25-P-EF-PR 6.919 €
VES-10-10-P-EF 3.910 €	VES-10-13-P-EF 4.130 €	VES-10-15-P-EF 4.589 €	VES-10-20-P-EF 5.473 €	VES-10-25-P-EF 7.124 €

Características técnicas y constructivas sujetas a variación sin previo aviso. / We reserve the right to change specifications without prior notice. / Sujet technique et la conception de modifications sans préavis.



CARACTERÍSTICAS TÉCNICAS

- Exterior e interior en chapa de acero plastificada
- Plano exposición y encimera en acero inox. AISI-304
- Bandejas plano de exposición lisas, con escalón sobre demanda
- Costados de 30 mm en ABS inyectado (modelo con reserva)
- Costado panorámico 20mm (modelo sin reserva)
- Perfilera en aluminio anodizado.
- Paragolpes en la parte delantera
- Cristal frontal templado y abatible, tres versiones disponibles
- Estante de cristal intermedio, opcional
- Iluminación estándar: encimera superior y base inferior LED
- Aislamiento de poliuretano inyectado, densidad 40 Kg/m³, bajo GWP y cero efecto ODP
- Reserva refrigerada con puertas, hueco 440x270 (excepto modelo neutro y modelo sin reserva)
- Evaporador ventilado, estático opcional
- Condensación ventilada y evaporación automática de serie
- Control electrónico de temperatura
- Descarche automático, opcional eléctrico
- Clase climática 4 (30°C 55% Hr) régimen M1 según UNE-EN ISO 23953-2
- Chasis en acero acabado epoxi
- Tensión de trabajo monofásica 220V 50Hz

TECHNICAL DATA

- Interior and exterior finish in plastic coated steel
- Display area and counter in stainless steel AISI-304
- Smooth deck for display area, stepped on demand
- 30 mm sides in injected ABS (model with storage)
- Panoramic side 20mm (model without storage)
- Anodised aluminium profiles
- Front rubber bumper
- Toughened curved glass hinges forward, three versions available
- Glass shelf non refrigerated, optional
- Standard lighting: top worktop and low level LED
- 40 Kg/m³ density polyurethane insulation, low GWP and zero ODP effect
- Refrigerated under storage with doors, 440x270 free (except neutral model and model without reservation)
- Ventilated evaporator, optional static evaporator
- Ventilated condensation and automatic defrost evaporation as standard
- Electronic temperature controller
- Automatic defrost, electric as optional
- Climatic class 4 (30 ° C 55% Hr) regime M1 according to UNE-EN ISO 23953-2
- Working voltage single phase 220V 50Hz
- Chassis in epoxy finished steel

CARACTÉRISTIQUES TECHNIQUES

- Extérieur et intérieur en acier plastifié.
- Surface d'exposition et plan de travail en inox. AISI-304
- Surface d'exposition lisse, possibilité double niveau sur demande
- Cotés de 30 mm en ABS injecté (modèle avec réserve)
- Panoramique cotés 20mm (modèle sans réserve)
- Profils en aluminium anodise
- Pare-chocs en partie frontale
- Vitre droite ou bombée sécurit rabattable
- Etagère en verre non réfrigérée
- Lumière standard en partie haute et base inferieur LED
- Isolation en polyuréthane injecté sans CFC, densité 40Kg/m³
- Stockage réfrigéré, espace 440x270 (sauf modèle neutre et le modèle sans réserve)
- Evaporateur ventilé
- Condensation ventilé, évaporation automatique en standard
- Contrôle de température électronique
- Dégivrage automatique, électrique en option
- Classe climatique 4 (30 ° C 55% Hr) régime M1 selon UNE-EN ISO 23953-2
- Tension de fonctionnement monophasé 220V 50Hz
- Châssis en acier fini époxy



4000K



RED FRESH



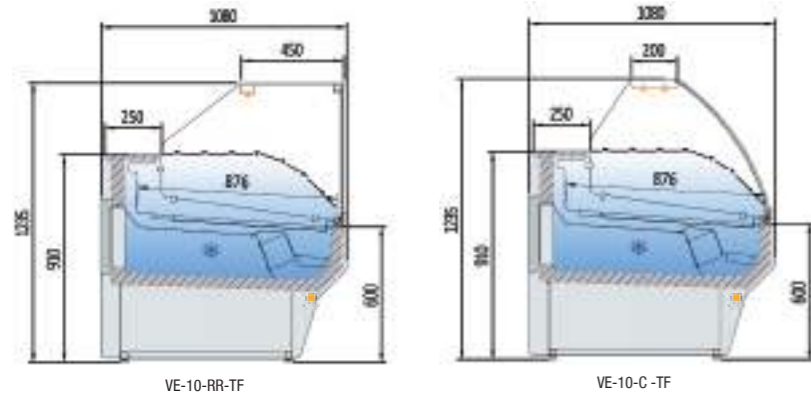

protector estornudos frontal (solo modelos RR, consultar)
front sneeze protector (RR models only, consult)
protection l'éternuement (modèles RR uniquement, consulter)



detalle separador de genero
detail separator genre
détail séparateur de genre

Ver características técnicas en página 56 / See technical data in page 56 / Voir caractéristiques techniques page 56

Modelo Model Modèle	Largo Length Longueur (mm)	Superficie de exposición Display area Surface d'exposition (m²)	Superficie total de exposición (TDA) Total display area (TDA) Surface totale de l'exposition (TDA) (m²)		Cámara VE Storage VE Stockage VE (lts.)	Puertas Doors Portes (Uds)	Potencia frig. Frig. Power Puissance frig. (W)	Consumo Nominal Nominal power Consommation nominale (W)	Refrigerante Coolant Réfrigérant
			(C)	(RR)					
VE-10-10-TF	1025	0,80	0,77	0,91	293	1	565	851	R-290
VE-10-13-TF	1265	1,00	0,96	1,13	369	2	572	912	R-290
VE-10-15-TF	1505	1,21	1,15	1,36	444	2	781	1046	R-290
VE-10-20-TF	1985	1,61	1,53	1,81	594	3	1098	1290	R-290
VE-10-25-TF	2465	2,01	1,91	2,26	745	4	1284	1354	R-290
VE-10-30-TF	2945	2,41	2,29	2,71	896	4	1284	1378	R-290

*Modelos en HFC, consultar precio / HFC Models, consult prices / Modèles HFC, consulter prix

230v 60Hz / 115v 60Hz. consultar - consult - consulter

PVP de opcionales incluidos en equipo, no como repuesto / PVP of options included in the equipment, not as a spare part / PVP d'options incluses dans l'équipement, pas en tant que pièce de rechange

Modelo Model Modèle	OPCIONES · OPTIONS · OPTIONS		Cierre Plexi Plexi slide Kit vitrage plexi	Iluminación led extra Extra led lighting Éclairage Led extra	Cierre cortina Night blind Rideau nocturne	Estante cristal iluminado Lighting Glass shelf Plateau en verre	Neutra Neutral Neutre	Pre Instalación Remote Unit Groupe à distance
	1 decoración frontal / front decor / décoration frontal	2 Total decoración / Total decor / décoration total						
VE-10-10-TF	140 €	460 €	118 €	57 €	175 €	179 €	-410 €	-120 €
VE-10-13-TF	150 €	471 €	173 €	78 €	242 €	228 €	-460 €	-135 €
VE-10-15-TF	164 €	481 €	201 €	93 €	292 €	267 €	-510 €	-145 €
VE-10-20-TF	174 €	489 €	252 €	112 €	321 €	360 €	-615 €	-180 €
VE-10-25-TF	184 €	495 €	335 €	148 €	378 €	450 €	-870 €	-205 €
VE-10-30-TF	194 €	502 €	397 €	160 €	581 €	506 €	-995 €	-255 €

Características técnicas y constructivas sujetas a variación sin previo aviso. / We reserve the right to change specifications without prior notice. / Sujet technique et la conception de modifications sans préavis.

VITRINA EXPOSITORA MODULAR VE-10 CON RESERVA

SERVE OVER COUNTER MODULAR VE-10 LINE RESERVATION WITH · VITRINE SERIE VE-10 GAMME AVEC RÉSERVATION

4000K RED FRESH



VE-10-15-RR-TF



VE-10-20-C-TF

Laterales incluidos en PVP / Sides included in PVP / Latéraux inclus dans PVP

VE-10-10-C-TF 3.103 €	VE-10-13-C-TF 3.376 €	VE-10-15-C-TF 3.742 €	VE-10-20-C-TF 4.321 €	VE-10-25-C-TF 5.269 €	VE-10-30-C-TF 5.961 €
VE-10-10-RR-TF 3.103 €	VE-10-13-RR-TF 3.376 €	VE-10-15-RR-TF 3.742 €	VE-10-20-RR-TF 4.321 €	VE-10-25-RR-TF 5.269 €	VE-10-30-RR-TF 5.961 €

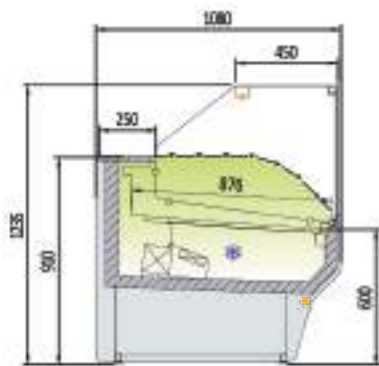

VES-10-RR-TF



protector estornudos frontal (solo modelos RR, consultar)
front sneeze protector (RR models only, consult)
protection l'éternuement (modèles RR uniquement, consulter)

De serie costado panorámico / (standard panoramic side) / (côté panoramique standard)

Ver características técnicas en página 56 / See technical data in page 56 / Voir caractéristiques techniques page 56

Modelo Model Modèle	Largo Length Longueur (mm)	Superficie de exposición Display area Surface d'exposition (m²)	Superficie total de exposición (TDA) Total display area (TDA) Surface totale de l'exposition (TDA) (m²)		Potencia frig. Frig. Power Puissance frig. (W)	Consumo Nominal Nominal power Consommation nominale (W)	Refrigerante Coolant Réfrigérant
			(C)	(RR)			
VES-10-10-TF	1025	0,80	0,77	0,91	565	851	R-290
VES-10-13-TF	1265	1,00	0,96	1,13	572	912	R-290
VES-10-15-TF	1505	1,21	1,15	1,36	781	1046	R-290
VES-10-20-TF	1985	1,61	1,53	1,81	1098	1290	R-290
VES-10-25-TF	2465	2,01	1,91	2,26	1284	1354	R-290
VES-10-30-TF	2945	2,41	2,29	2,71	1284	1378	R-290

*Modelos en HFC, consultar precio / HFC Models, consult prices / Modèles HFC, consulter prix

230v 60Hz / 115v 60Hz. consultar - consult - consulter

PVP de opcionales incluidos en equipo, no como repuesto / PVP of options included in the equipment, not as a spare part / PVP d'options incluses dans l'équipement, pas en tant que pièce de rechange

Modelo Model Modèle	OPCIONES · OPTIONS · OPTIONS		Cierre Plexi Plexi slide Kit vitrage plexi	Iluminación led extra Extra led lighting Éclairage Led extra	Cierre cortina Night blind Rideau nocturne	Estante cristal iluminado Lighting Glass shelf Plateau en verre	Neutra Neutral Neutre	Pre Instalación Remote Unit Groupe à distance
	1 decoración frontal / front decor / décoration frontal	2 Total decoración / Total decor / décoration total						
VE-10-10-TF	140 €	460 €	118 €	57 €	175 €	179 €	-410 €	-120 €
VE-10-13-TF	150 €	471 €	173 €	78 €	242 €	228 €	-460 €	-135 €
VE-10-15-TF	164 €	481 €	201 €	93 €	292 €	267 €	-510 €	-145 €
VE-10-20-TF	174 €	489 €	252 €	112 €	321 €	360 €	-615 €	-180 €
VE-10-25-TF	184 €	495 €	335 €	148 €	378 €	450 €	-870 €	-205 €
VE-10-30-TF	194 €	502 €	397 €	160 €	581 €	506 €	-995 €	-255 €

Características técnicas y constructivas sujetas a variación sin previo aviso. / We reserve the right to change specifications without prior notice. / Sujet technique et la conception de modifications sans préavis.

VITRINA EXPOSITORA MODULAR VE-10 SIN RESERVA

SERVE OVER COUNTER MODULAR LINE RESERVATION WITHOUT VE-10 · VITRINE SERIE VE-10 GAMME SANS RÉSERVATION

4000K RED FRESH



A ↑ E Clase Eficiencia Energética (Pag. 9)
Energy Efficiency Class (Pag. 9)

Laterales incluidos en PVP / Sides included in PVP / Latéraux inclus dans PVP

VES-10-10-TF 3.027 €	VES-10-13-TF 3.313 €	VES-10-15-TF 3.685 €	VES-10-20-TF 4.187 €	VES-10-25-TF 5.061 €	VES-10-30-TF 5.735 €

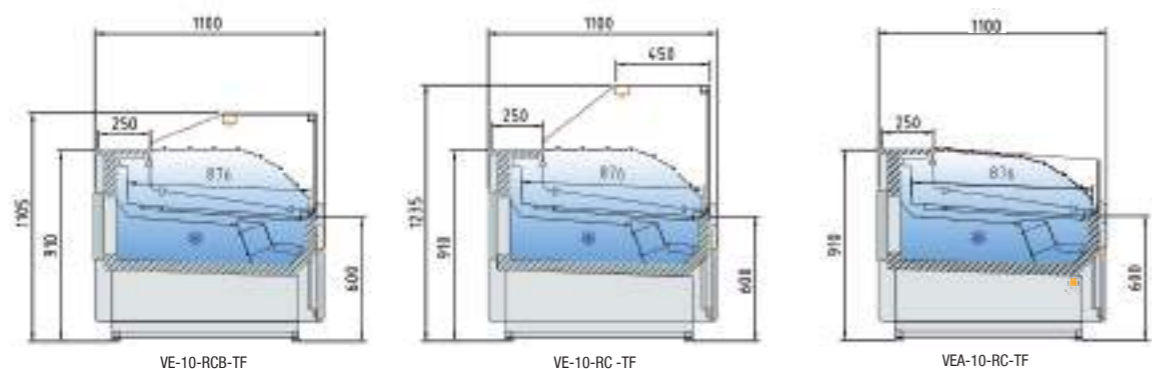

protector estornudos frontal (solo modelos RR, consultar)
front sneeze protector (RR models only, consult)
protection l'éternement (modèles RR uniquement, consulter)



Ejemplo VEA-RC-TF
Example VEA-RC-TF
Exemple VEA-RC-TF

4000K RED FRESH



VE-10-20-RC-TF

Franja superior inox
Stainless steel upper strip
Bande supérieure en acier inoxydable

Franja frontal decorativa (Carta colores pag. 16)
Decorative front stripe (Color chart page 16)
Bande décorative devant (Nuancier page 16)

Base inferior color RAL 7024 en todas las opciones
Lower base color RAL 7024 (in all options)
Couleur de base inférieure RAL 7024 (dans toutes les options)

Ver características técnicas en página 56 / See technical data in page 56 / Voir caractéristiques techniques page 56

Modelo Model Modèle	Largo Length Longueur (mm)	Superficie de exposición Display area Surface d'exposition (m²)	Superficie total de exposición (TDA) Total display area (TDA) Surface totale de l'exposition (TDA) (m²)			Cámara VE Storage VE Stockage VE (lts.)	Puertas Doors Portes (Uds)	Potencia frig. Frig. Power Puissance frig. (W)	Consumo Nominal Nominal power Consommation nominale (W)	Refrigerante Coolant Régfrigérant
			(RCB)	(RC)	(VEA)					
VE / VEA-10-10-RC-TF	1025	0,80	0,91	0,91	0,97	293	1	565	851	R-290
VE / VEA-10-13-RC-TF	1265	1,00	1,13	1,13	1,21	369	2	572	912	R-290
VE / VEA-10-15-RC-TF	1505	1,21	1,36	1,36	1,45	444	2	781	1046	R-290
VE / VEA-10-20-RC-TF	1985	1,61	1,81	1,81	1,93	594	3	1098	1290	R-290
VE / VEA-10-25-RC-TF	2465	2,01	2,26	2,26	2,41	745	4	1284	1354	R-290
VE / VEA-10-30-RC-TF	2945	2,41	2,71	2,71	2,89	896	4	1284	1378	R-290

*Modelos en HFC, consultar precio / HFC Models, consult prices / Modèles HFC, consulter prix

230v 60Hz / 115v 60Hz. consultar - consult - consulter

PVP de opcionales incluidos en equipo, no como repuesto / PVP of options included in the equipment, not as a spare part / PVP d'options incluses dans l'équipement, pas en tant que pièce de rechange

Modelo Model Modèle	OPCIONES · OPTIONS · OPTIONS		Cierre Plexi Plexi slide Kit vitrage plexi	Iluminación led extra Extra led lighting Éclairage Led extra	Cierre cortina Night blind Rideau nocturne	Estante cristal iluminado Lighting Glass shelf Plateau en verre	Neutra Neutral Neutre	Pre Instalación Remote Unit Groupe à distance
	1 decoración frontal / front decor / décoration frontal	2 Total decoración / Total decor / décoration total						
VE / VEA-10-10-RC-TF	140 €	460 €	118 €	57 €	175 €	179 €	-410 €	-120 €
VE / VEA-10-13-RC-TF	150 €	471 €	173 €	78 €	242 €	228 €	-460 €	-135 €
VE / VEA-10-15-RC-TF	164 €	481 €	201 €	93 €	292 €	267 €	-510 €	-145 €
VE / VEA-10-20-RC-TF	174 €	489 €	252 €	112 €	321 €	360 €	-615 €	-180 €
VE / VEA-10-25-RC-TF	184 €	495 €	335 €	148 €	378 €	450 €	-870 €	-205 €
VE / VEA-10-30-RC-TF	194 €	502 €	397 €	160 €	581 €	506 €	-995 €	-255 €

Características técnicas y constructivas sujetas a variación sin previo aviso. / We reserve the right to change specifications without prior notice. / Sujet technique et la conception de modifications sans préavis.

Laterales incluidos en PVP / Sides included in PVP / Latéraux inclus dans PVP

VEA-10-10-RC TF 3.390 €	VEA-10-13-RC TF 3.708 €	VEA-10-15-RC TF 4.217 €	VEA-10-20-RC TF 4.592 €	VEA-10-25-RC TF 5.579 €	VEA-10-30-RC TF 6.724 €
VE-10-10-RCB-TF 3.157 €	VE-10-13-RCB-TF 3.341 €	VE-10-15-RCB-TF 3.704 €	VE-10-20-RCB-TF 4.276 €	VE-10-25-RCB-TF 5.216 €	VE-10-30-RCB-TF 6.013 €
VE-10-10-RC-TF 3.192 €	VE-10-13-RC-TF 3.445 €	VE-10-15-RC-TF 3.819 €	VE-10-20-RC-TF 4.409 €	VE-10-25-RC-TF 5.377 €	VE-10-30-RC-TF 6.199 €



Ver características técnicas en página 56 / See technical data in page 56 / Voir caractéristiques techniques page 56

Laterales incluidos en PVP / Sides included in PVP / Latéraux inclus dans PVP

CARACTERÍSTICAS TÉCNICAS ÁNGULOS REFRIGERADOS

- Sistema de evaporación ventilado
- Modelos AP45 y AN45 neutros
- VES vitrina sin reserva (de serie costado panorámico)
- VE vitrina con reserva
- C: Cristal curvo
- Mismo precio para cristales C, RR
- Todos los modelos sin puerta de reserva

REFRIGERATED ANGLE TECHNICAL DATA

- Ventilated evaporation system
- Neutral models AP45 y AN45
- VES without storage (standard panoramic side)
- VE with storage
- C: Curved glass
- Same price for glass C, RR
- All door models without reservation

CARACTÉRISTIQUES TECHNIQUES DES ANGLES RÉFRIGÉRÉS

- Système d'évaporation ventilé
- Modèles AP45 y AN45 neutros
- VES sans stockage (côté panoramique standard)
- VE stockage
- C: Vitre bombée
- Même prix pour le verre C, RR
- Tous les modèles sans portes de réserve

CARACTERÍSTICAS TÉCNICAS MUEBLES CAJAS

- Todos los modelos con cajón incorporado, estantes y enchufe
- Modelo MCVE-DIS frontal adaptado a discapacitados
- Modelo MCVE frontal recto

CASH NEUTRAL COUNTER DATA

- All models with built-in drawer, shelves and plug
- Front MCVE-DIS model adapted for the disabled
- Straight front MCVE model

CARACTÉRISTIQUES TECHNIQUES DES MEUBLE CAISSE

- Tous les modèles avec tiroir intégré, étagères et prise
- Modèle avant MCVE-DIS adapté aux handicapés
- Modèle MCVE à façade droite

PVP de opcionales incluidos en equipo, no como repuesto / PVP of options included in the equipment, not as a spare part / PVP d'options incluses dans l'équipement, pas en tant que pièce de rechange

ÁNGULOS NEGATIVOS / NEGATIVE ANGLES / NÉGATIF ANGLES			ÁNGULOS POSITIVOS / POSITIVE ANGLES / POSITIF ANGLES		
	VE-10-RN90	6.347 €		VE-10-AN90	6.406 €
	VES-10-RN90	6.149 €		VE-10-RP90	5.784 €
	VE-10-AN45	4.136 €		VE-10-AP90	5.843 €
	VES-10-AN45	4.136 €		VE-10-AP45	4.136 €
	VES-10-AN90	6.265 €		VES-10-RP90	5.678 €
				VES-10-AP90	5.790 €
				VES-10-AP45	4.136 €

Mismo precio modelos RC / Same price RC models / Modèles RC au même prix

*Modelos en HFC, consultar precio / HFC Models, consult prices / Modèles HFC, consulter prix
 230v 60Hz / 115v 60Hz - consultar - consult - consulter

OPCIONES · OPTIONS · OPTIONS

Modelo	1 decoración frontal / front decor / décoration frontal	2 Total decoración / Total decor / décoration total	Cierre Plexi Plexi slide Kit vitrage coulissant plexi	Iluminación led led lighting Éclairage Led blanc
VE/VES-10-AP90	156 €	502 €	271 €	93 €
VE/VES-10-RP90	156 €	502 €	271 €	93 €
VE/VES-10-AN90	156 €	502 €	271 €	93 €
VE/VES-10-RN90	156 €	502 €	271 €	93 €
VE/VES-10-AP45	156 €	502 €	271 €	93 €
VE/VES-10-AN45	156 €	502 €	271 €	93 €

DETALLE FRONTAL / FRONT DETAIL
DÉTAIL AVANT



Modelo Model Modèle	Total decoración Total decor Décoration total
MCVE-10-8-DIS	460 €
MCVE-10-8	460 €
MCVE-10-12-DIS	471 €
MCVE-10-12	471 €

MUEBLES CAJA NEUTROS
CASH NEUTRAL COUNTER / MEUBLE CAISSE NEUTRE

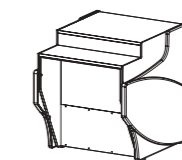

MCVE-10-8-DIS **1.555 €**
 MCVE-10-8 **1.555 €**

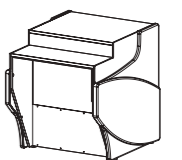

MCVE-10-12-DIS **1.720 €**
 MCVE-10-12 **1.720 €**

Modelo Model Modèle	Largo Length Longueur (mm)	Alto Height Hauteur (mm)	Fondo Depth Profondeur (mm)	Superficie de exposición Display area Surface d'exposition (m²)	Superficie total de exposición (TDA) Total display area (TDA) Surface totale de l'exposition (TDA) (m²)		Cámara VE Storage VE Stockage VE (m³)	Puertas Doors Portes (Uds)	Potencia frig. Frig. Power Puissance frig. (W)	Consumo Consumption Consommation (W)	Refrigerante Coolant Réfrigérant
					(C)	(RR)					
VE/VES-10-AN90-TF	1565	1230	1565	1,22	0,88	1,12	-	0	583	939	R-290
VE/VES-10-AP90-TF	1520	1230	1520	1,31	1,52	1,72	-	0	796	1084	R-290
VE/VES-10N-AN45-TF	1140	1230	1250	0,61	-	-	-	0	-	10	
VE/VES-10N-AP45-TF	1110	1230	1235	0,66	-	-	-	0	-	10	
VE/VES-10-RN90-TF	1575	1230	1575	1,49	1,08	1,36	-	0	583	926	R-290
VE/VES-10-RP90-TF	1385	1230	1385	1,36	1,63	1,83	-	0	583	957	R-290
MCVE-10-8	800	910	1100	0,78	-	-	-	-	-	-	
MCVE-10-12	1200	910	1100	1,21	-	-	-	-	-	-	

Características técnicas y constructivas sujetas a variación sin previo aviso / We reserve the right to change specifications without prior notice / Sujet technique et la conception de modifications sans préavis

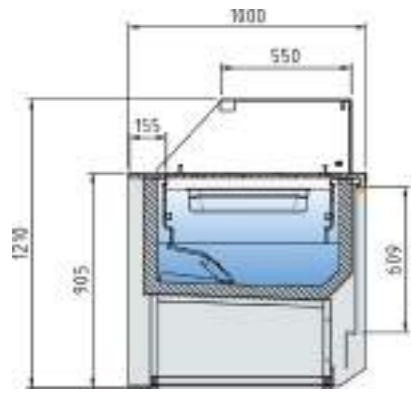

VETB-10-GN-1/1

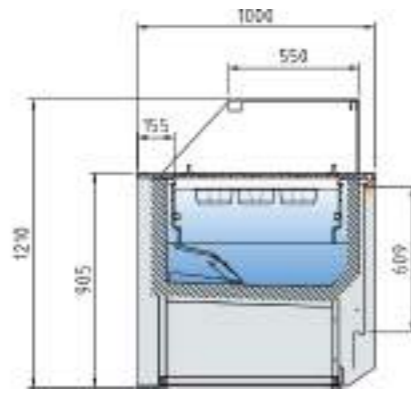

VETB-10-GN-1/6



Detalle encimera VETB-10-15 GN-1/1
Counter detail VETB-10-15 GN-1/1
Détail du comptoir VETB-10-15 GN-1/1

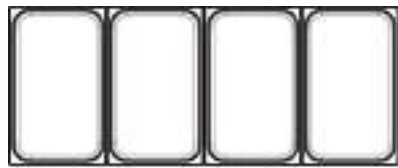

VETB-10-15-GN-1/1

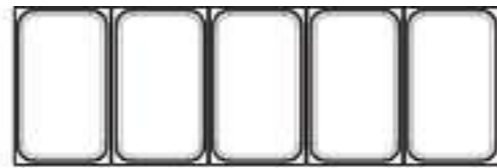

VETB-10-20-GN-1/1

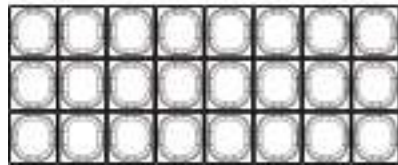

VETB-10-15-GN-1/6



VETB-10-20-GN-1/6

Otros modelos de cubetas consultar / Other models of buckets consult / Autres modèles de godets consulter

Ver características técnicas en página 56 / See technical data in page 56 / Voir caractéristiques techniques page 56

Modelo Model Modèle	Largo Length Longueur (mm)	Superficie de exposición Display area Surface d'exposition (m²)	Superficie total de exposición (TDA) Total display area (TDA) Surface totale de l'exposition (TDA) (m²)	Capacidad cubetas Tray capacity Capacité plateau (GN)	Potencia frigorífica Cooling capacity Puissance frigorifique (W)	Consumo Nominal Nominal power Consommation nominale (W)	Refrigerante Coolant Réfrigérant
VETB-10-15-TF 1/1	1505	0,94	0,88	4 GN 1/1	781	1032	R-290
VETB-10-15-TF 1/6	1505	0,94	0,88	24 GN 1/6	781	1032	R-290
VETB-10-20-TF 1/1	1985	1,27	1,19	5 GN 1/1	1098	1276	R-290
VETB-10-20-TF 1/6	1985	1,27	1,19	30 GN 1/6	1098	1276	R-290

*Modelos en HFC, consultar precio / HFC Models, consult prices / Modèles HFC, consulter prix

230v 60Hz / 115v 60Hz. consultar - consult - consulter

PVP de opcionales incluidos en equipo, no como repuesto / PVP of options included in the equipment, not as a spare part / PVP d'options incluses dans l'équipement, pas en tant que pièce de rechange

OPCIONES · OPTIONS · OPTIONS			
Modelo Model Modèle	Cierre Plexi Plexi Slide Kit Vitrage plexi	Pre Instalación Remote Unit Groupe à distance	Neutra Neutral Neutre
VETB-10-15-TF	201 €	-510 €	-145 €
VETB-10-20-TF	252 €	-615 €	-180 €

Características técnicas y constructivas sujetas a variación sin previo aviso. / We reserve the right to change specifications without prior notice. / Sujet technique et la conception de modifications sans préavis.



VETB-10-15-TF GN-1/6

Laterales y cubetas incluidos en PVP / Sides and trays included in PVP / Latéraux et plateau inclus dans PVP

VETB-10-15-TF-GN-1/1 4.722 €	VETB-10-20-TF-GN-1/1 5.074 €	VETB-10-15-TF-GN-1/6 5.402 €	VETB-10-20-TF-GN-1/6 5.842 €

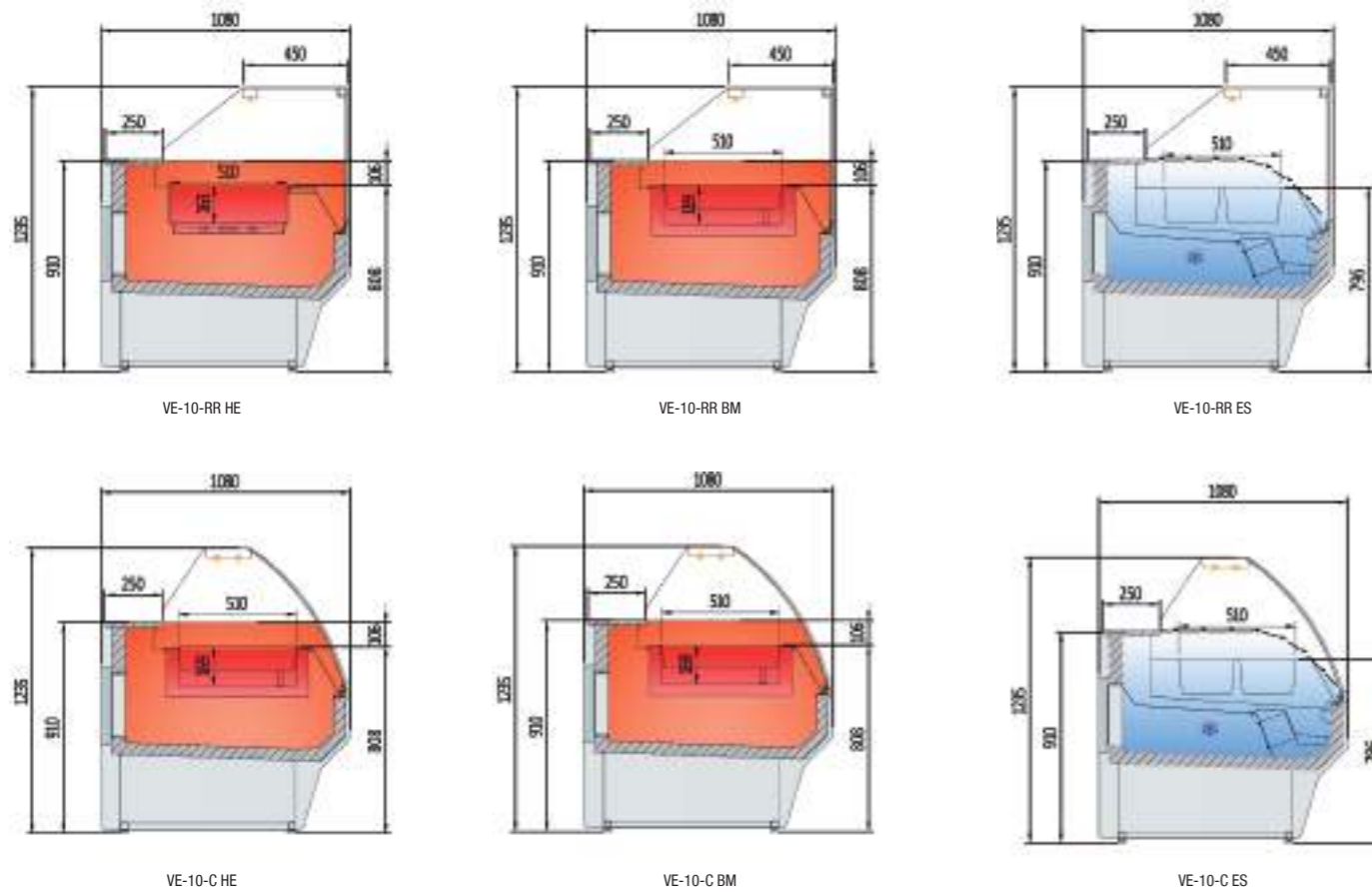

□□□□□ 4000K
 ●●●●● RED FRESH

Modelo Model Modèle	Largo Length Longueur (mm)	Capacidad cubetas Tray capacity Capacité plateau (GN)	Potencia frig. Frig. Power Puissance frig. (W)	Consumo Nominal Nominal power Consommation nominale (W)	Refrigerante Coolant Réfrigérant
VE-10BM-10	1025	2 GN 1/1-150	-	2000	-
VE-10BM-13	1265	3 GN 1/1-150	-	2000	-
VE-10BM-15	1505	4 GN 1/1-150	-	3000	-
VE-10BM-20	1985	5 GN 1/1-150	-	3000	-
VE-10BM-25	2465	6 GN 1/1-150	-	4000	-
VE-10-10-HE	1025	2 GN 1/1-150	-	800	-
VE-10-13-HE	1265	3 GN 1/1-150	-	1200	-
VE-10-15-HE	1505	4 GN 1/1-150	-	1600	-
VE-10-20-HE	1985	5 GN 1/1-150	-	2000	-
VE-10-25-HE	2465	6 GN 1/1-150	-	2400	-
VE-10ES-10	1025	2 GN 1/1 + 2 GN 1/4	483	851	R-290
VE-10ES-13	1265	3 GN 1/1-150	572	912	R-290
VE-10ES-15	1505	4 GN 1/1-150	781	1046	R-290
VE-10ES-20	1985	5 GN 1/1 + 2 GN 1/4	1098	1290	R-290
VE-10ES-25	2465	7 GN 1/1-150	1284	1354	R-290

CARACTERÍSTICAS TÉCNICAS	TECHNICAL DATA	CARACTÉRISTIQUES TECHNIQUES
<ul style="list-style-type: none"> Plano de exposición, con alojamientos para cubetas GN, fondo máximo 150 mm (cubetas no incluidas) VE-ES Cubetas refrigeradas VE-HE Calor seco temperatura de trabajo +55°C+70°C VE-BM Calor baño maría Recomendamos no poner estante intermedio Los módulos se podrán integrar en modelos de vitrina VE-10 	<ul style="list-style-type: none"> Exposition display for GN trays, maximum depth 150 mm (trays not included) VE-ES Refrigerated trays VE-HE Dry heat working temperature +55°C+70°C VE-BM Heat bath We recommend not putting intermediate shelf The modules can be integrated into cabinet model VE-10 	<ul style="list-style-type: none"> Surface d'exposition cuvette avec hébergement GN, profondeur maximale 150mm (plateaux non inclus) VE-ES Plateaux réfrigérés VE-HE chaleur sèche température de travail +55°C+70°C VE-BM bain de chaleur Nous recommandons de ne pas mettre étagère intermédiaire Les modules peuvent être intégrés modèle d'enceinte VE-10

Características técnicas y constructivas sujetas a variación sin previo aviso. / We reserve the right to change specifications without prior notice. / Sujet technique et la conception de modifications sans préavis.

Laterales incluidos en PVP / Sides included in PVP / Latéraux inclus dans PVP

<p>CUBETAS REFRIGERADAS REFRIGERATED TRAYS TASSES RÉFRIGÉRÉS</p>	<p>VE-10-10-ES-TF 3.302 €</p>	<p>VE-10-13-ES-TF 3.601 €</p>	<p>VE-10-15-ES-TF 3.994 €</p>	<p>VE-10-20-ES-TF 4.612 €</p>	<p>VE-10-25-ES-TF 5.601 €</p>
<p>BAÑO MARIA BAIN MARIE BAIN-MARIE</p>	<p>VE-10-10-BM 4.319 €</p>	<p>VE-10-13-BM 4.830 €</p>	<p>VE-10-15-BM 5.364 €</p>	<p>VE-10-20-BM 6.235 €</p>	<p>VE-10-25-BM 8.111 €</p>
<p>CALOR SECO DRY HEAT CHALEUR SÈCHE</p>	<p>VE-10-10-HE 3.375 €</p>	<p>VE-10-13-HE 3.680 €</p>	<p>VE-10-15-HE 4.078 €</p>	<p>VE-10-20-HE 4.767 €</p>	<p>VE-10-25-HE 5.596 €</p>

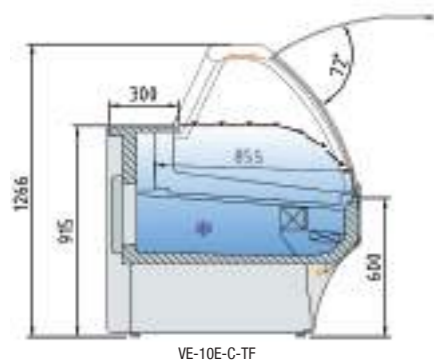

VE-10E-C-TF



detalle cristal elevable
detail lifting glass
detail vitre rabattable

4000K RED FRESH



VE-10E-20-C-TF

CARACTERÍSTICAS TÉCNICAS	TECHNICAL DATA	CARACTÉRISTIQUES TECHNIQUES
<ul style="list-style-type: none"> Cristal frontal templado y elevable. Estante de cristal intermedio, opcional Iluminación estándar: encimera superior led Reserva refrigerada con puertas, hueco 440x270 Evaporador ventilado. Condensación ventilada, evaporación automática de serie 	<ul style="list-style-type: none"> Toughened curved and liftable glass. Glass shelf non refrigerated, optional Refrigerated under storage with doors, 440x270 without reservation Ventilated evaporator Ventilated condensation and automatic defrost evaporation as standard 	<ul style="list-style-type: none"> Vitre bombée sécurit rabattable levée Etagère en verre non réfrigérée Lumière standard en partie haute led Stockage réfrigéré, espace 440x270 Evaporateur statique Condensation ventilé, évaporation automatique en standard

Ver características técnicas en página 56 / See technical data in page 56 / Voir caractéristiques techniques page 56

Modelo / Model / Modèle	Largo / Length / Longueur (mm)	Superficie de exposición / Display area / Surface d'exposition (m²)	Superficie total de exposición (TDA) / Total display area (TDA) / Surface totale de l'exposition (TDA) (m²)	Cámara VE / Storage VE / Stockage VE (lts.)	Puertas / Doors / Portes (Uds)	Potencia frig. / Frig. Power / Puissance frig. (W)	Consumo Nominal / Nominal power / Consommation nominale (W)	Refrigerante / Coolant / Réfrigérant
VE-10E-10-TF	1025	0,80	0,70	293	1 / 0	565	851	R-290
VE-10E-13-TF	1265	1,00	0,87	369	2 / 0	572	912	R-290
VE-10E-15-TF	1505	1,21	1,05	444	2 / 0	781	1046	R-290
VE-10E-20-TF	1985	1,61	1,39	594	3 / 0	1098	1290	R-290
VE-10E-25-TF	2465	2,01	1,74	745	4 / 0	1284	1354	R-290
VE-10E-30-TF	2945	2,41	2,09	896	4 / 0	1284	1378	R-290

*Modelos en HFC, consultar precio / HFC Models, consult prices / Modèles HFC, consulter prix
230v 60Hz / 115v 60Hz. consultar - consult - consulter



VE-10E-20-C-TF + VE-10E-20-C-TF

PVP de opcionales incluidos en equipo, no como repuesto / PVP of options included in the equipment, not as a spare part / PVP d'options incluses dans l'équipement, pas en tant que pièce de rechange

Modelo / Model / Modèle	OPCIONES · OPTIONS · OPTIONS		Cierre Plexi / Plexi slide / Kit vitrage plexi	Iluminación led blanco / White led lighting / Éclairage Led blanc	Cierre cortina / Night blind / Rideau nocturne	Estante cristal iluminado / Lighting Glass shelf / Plateau en verre illuminé	Neutra / Neutral / Neutre	Pre Instalación Remote Unit / Groupe à distance
	1 decoración frontal / front decor / décoration frontal	2 Total decoración / Total decor / décoration total						
VE-10E-10-TF	140 €	460 €	118 €	57 €	175 €	179 €	-410 €	-120 €
VE-10E-13-TF	150 €	471 €	173 €	78 €	242 €	228 €	-460 €	-135 €
VE-10E-15-TF	164 €	481 €	201 €	93 €	292 €	267 €	-510 €	-145 €
VE-10E-20-TF	174 €	489 €	252 €	112 €	321 €	360 €	-615 €	-180 €
VE-10E-25-TF	184 €	495 €	335 €	148 €	378 €	450 €	-870 €	-205 €
VE-10E-30-TF	194 €	502 €	397 €	160 €	581 €	506 €	-995 €	-255 €

Laterales incluidos en PVP / Sides included in PVP / Latéraux inclus dans PVP

VE-10E-10-C-TF 3.772 €	VE-10E-13-C-TF 3.914 €	VE-10E-15-C-TF 4.350 €	VE-10E-20-C-TF 5.193 €	VE-10E-25-C-TF 6.069 €	VE-10E-30-C-TF 7.197 €

Características técnicas y constructivas sujetas a variación sin previo aviso / We reserve the right to change specifications without prior notice / Sujet technique et la conception de modifications sans préavis

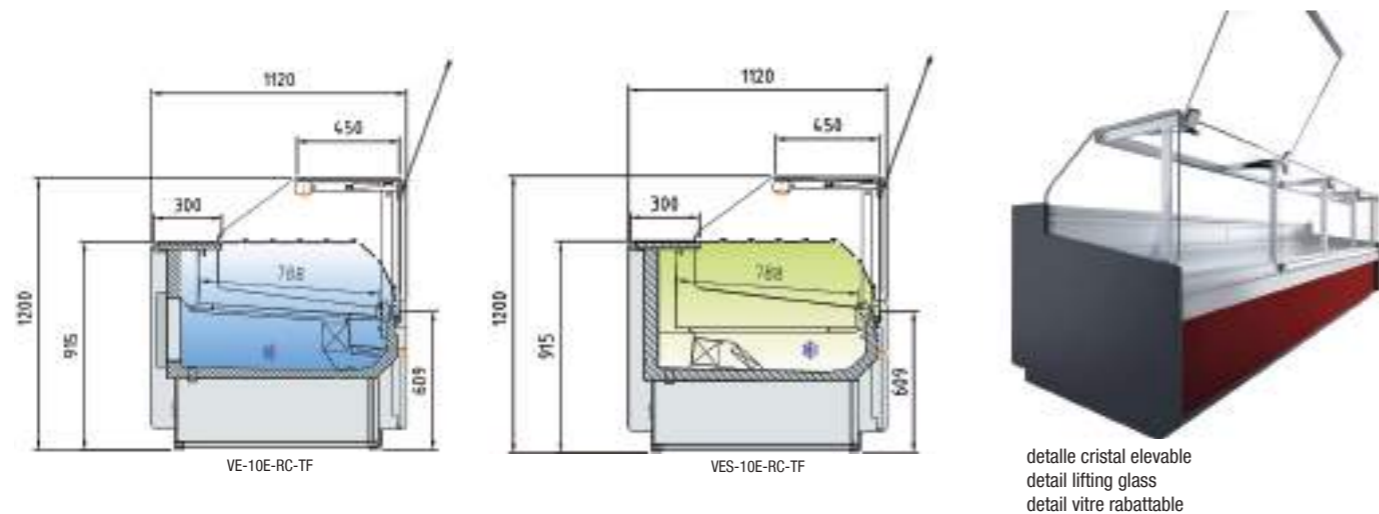

detalle cristal elevable
detail lifting glass
detail vitre rabattable



Franja superior inox
Stainless steel upper strip
Bande supérieure en acier inoxydable

Franja frontal decorativa (Carta colores pag. 16)
Decorative front stripe (Color chart page 16)
Bande décorative devant (Nuancier page 16)

Base inferior color RAL 7024
en todas las opciones)
Lower base color RAL 7024 (in all options)
Couleur de base inférieure RAL 7024
(dans toutes les options)

VE-10E-20-RC-TF

CARACTERÍSTICAS TÉCNICAS	TECHNICAL DATA	CARACTÉRISTIQUES TECHNIQUES
<ul style="list-style-type: none"> Cristal frontal templado y elevable. Estante de cristal intermedio, opcional Iluminación estándar: encimera superior led Reserva refrigerada con puertas, hueco 440x270 (excepto modelo neutro y sin reserva) Evaporador ventilado. Condensación ventilada, evaporación automática de serie Evaporación estática opcional 	<ul style="list-style-type: none"> Toughened curved and liftable glass. Glass shelf non refrigerated, optional Refrigerated under storage with doors, 440x270free (except for ambient models and without reservation) Ventilated evaporator Ventilated condensation and automatic defrost evaporation as standard Optional static evaporation 	<ul style="list-style-type: none"> Vitre bombée sécurit rabattable levée Etagère en verre non réfrigérée Lumière standard en partie haute led Stockage réfrigéré, espace 440x270 (sauf modèles neutres et sans réservation) Evaporateur statique Condensation ventilé, évaporation automatique en standard Évaporation statique en option

Ver características técnicas en página 56 / See technical data in page 56 / Voir caractéristiques techniques page 56

Modelo / Model / Modèle	Largo / Length / Longueur (mm)	Superficie de exposición / Display area / Surface d'exposition (m²)	Superficie total de exposición (TDA) / Total display area (TDA) / Surface totale de l'exposition (TDA) (m²)	Cámara VE / Storage VE / Stockage VE (lts.)	Puertas / Doors / Portes (Uds)	Potencia frig. / Frig. Power / Puissance frig. (W)	Consumo Nominal / Nominal power / Consommation nominale (W)	Refrigerante / Coolant / Réfrigérant
VE / VES-10E-10-RC-TF	1025	0,80	0,91	293	1 / 0	565	851	R-290
VE / VES-10E-13-RC-TF	1265	1,00	1,13	369	2 / 0	572	912	R-290
VE / VES-10E-15-RC-TF	1505	1,21	1,36	444	2 / 0	781	1046	R-290
VE / VES-10E-20-RC-TF	1985	1,61	1,81	594	3 / 0	1098	1290	R-290
VE / VES-10E-25-RC-TF	2465	2,01	2,26	745	4 / 0	1284	1354	R-290
VE / VES-10E-30-RC-TF	2945	2,41	2,71	896	4 / 0	1284	1378	R-290

230v 60Hz / 115v 60Hz. consultar - consult - consulter
Modelo estático / Static model / Statique modelé consultar - consult - consulter
*Modelos en HFC, consultar precio / HFC Models, consult prices / Modèles HFC, consulter prix

PVP de opcionales incluidos en equipo, no como repuesto / PVP of options included in the equipment, not as a spare part / PVP d'options incluses dans l'équipement, pas en tant que pièce de rechange

Modelo / Model / Modèle	OPCIONES · OPTIONS · OPTIONS		Cierre Plexi / Plexi slide / Kit vitrage plexi	Iluminación led blanco / White led lighting / Éclairage Led blanc	Cierre cortina / Night blind / Rideau nocturne	Estante cristal iluminado / Lighting Glass shelf / Plateau en verre illuminé	Neutra / Neutral / Neutre	Pre Instalación Remote Unit / Groupe à distance
	1 decoración frontal / front decor / décoration frontal	2 Total decoración / Total decor / décoration total						
VE / VES-10E-10-RC-TF	140 €	460 €	118 €	57 €	175 €	179 €	-410 €	-120 €
VE / VES-10E-13-RC-TF	150 €	471 €	173 €	78 €	242 €	228 €	-460 €	-135 €
VE / VES-10E-15-RC-TF	164 €	481 €	201 €	93 €	292 €	267 €	-510 €	-145 €
VE / VES-10E-20-RC-TF	174 €	489 €	252 €	112 €	321 €	360 €	-615 €	-180 €
VE / VES-10E-25-RC-TF	184 €	495 €	335 €	148 €	378 €	450 €	-870 €	-205 €
VE / VES-10E-30-RC-TF	194 €	502 €	397 €	160 €	581 €	506 €	-995 €	-255 €

Características técnicas y constructivas sujetas a variación sin previo aviso / We reserve the right to change specifications without prior notice / Sujet technique et la conception de modifications sans préavis





LINEAL VE-10E-20-RC-TF + VE-10E-20-RC-TF

ÁNGULOS POSITIVOS / POSITIVE ANGLES / POSITIF ANGLES	
VE-10E-RP90-RC	7.526 €
VES-10E-RP90-RC	7.377 €
VE-10E-AP90-RC	7.526 €
VES-10E-AP90-RC	7.377 €

Laterales incluidos en PVP / Sides included in PVP / Latéraux inclus dans PVP					
VE-10E-10-RC-TF	3.997 €	VE-10E-13-RC-TF	4.274 €	VE-10E-15-RC-TF	4.700 €
VE-10E-10-RC-TF	3.912 €	VES-10E-13-RC-TF	4.171 €	VES-10E-15-RC-TF	4.603 €
VE-10E-20-RC-TF	5.506 €	VE-10E-25-RC-TF	6.620 €	VE-10E-30-RC-TF	7.175 €
VES-10E-20-RC-TF	5.202 €	VES-10E-25-RC-TF	6.333 €	VES-10E-30-RC-TF	6.948 €



CARACTERÍSTICAS TÉCNICAS	TECHNICAL DATA	CARACTÉRISTIQUES TECHNIQUES
<ul style="list-style-type: none"> • Sistema de frío ventilado • Reserva refrigerada con puertas, hueco 440x270 (excepto modelo neutro) • Plano de exposición en acero INOX horizontal y elevado. • Máxima visibilidad • Sin estante intermedio • Leds bajo encimera de trabajo • Cristal templado • Encimera de cuarzo tecnológico color blanco • Laterales de 30mm y frontal en DM hidrófugo + PVC o Lacado alto brillo metalizados • Evaporador tratado con epoxi anticorrosión • Condensación ventilada, evaporación automática de serie • Clase climática 3 (25°C 60% Hr) régimen M1 según UNE-EN ISO 23953-2 • Chasis en acero acabado epoxi • Tensión de trabajo monofásica 220V 50Hz • Modelo preinstalación (PR) solo evaporador, control y válvulas solenoide y expansión termostática R-449A / R-134a • Modelo VEGPC con columnas y estantes de cristal 	<ul style="list-style-type: none"> • Ventilated cold system • Refrigerated under storage with doors 440x270 (except neutral model) • Exposition display in Stainless steel horizontal and high. • Maximum visibility • Without intermediate shelf • Leds under worktop • Tempered glass • White technological quartz countertop • Side and front 30mm waterproof MDF + PVC or highgloss metallic-lacquered • High gloss epoxy corrosion treated evaporator • Condensation ventilated, automatic evaporation of as standard defrost • Climatic class 3 (25°C 60% Hr) regime M1 according to UNE-EN ISO 23953-2 • Working voltage single phase 220V 50Hz • Chassis in epoxy finished steel • Pre-installation model (PR) single evaporator, control and solenoid valves and thermostatic expansion R-449A / R-134a • VEGPC Model with columns and glass shelves 	<ul style="list-style-type: none"> • Système de froid ventilé • Réserve refroidi portes, 440x270 creux (sauf modèle neutre) • Exposition Plano en acier inoxydable horizontale et haute. • Une visibilité maximale • Aucune étagère intermédiaire • Leds sous plan de travail • Le verre trempé • Quartz comptoir blanc technologiques • Côté et avant 30mm étanche MDF + PVC ou brillant époxy corrosion évaporateur traité métallique laqué • De la condensation ventilé, évaporation automatique de série • Classe climatique 3 (25°C 60% Hr) régime M1 selon UNE-EN ISO 23953-2 • Tension de fonctionnement monophasé 220V 50Hz • Châssis en acier fini époxy • Évaporateur simple de modèle de pré-installation (PR), électrovannes de contrôle et d'électro-aimant et expansion thermostatique R-449A / R-134a • Modèle VEGPC avec des colonnes et étagères en verre
<ul style="list-style-type: none"> • Decoración incluida  • Decoraciones especiales: consultar 	<ul style="list-style-type: none"> • Decorations included  • Special decorations: consult 	<ul style="list-style-type: none"> • Décorations inclus  • Décorations spéciales: consulter



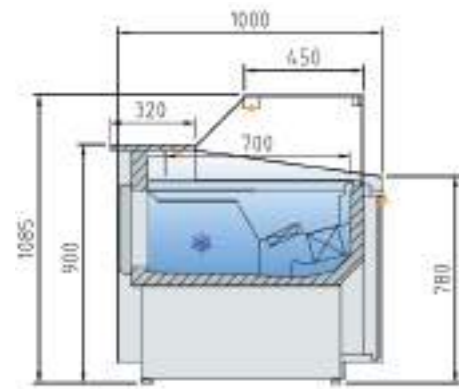

VEG-10



4000K 3000K



Ejemplo línea VEG-10-15-TF + VEG-10-15-TF + MCVEG-10-10 + MCT-70-VEG
VEG-10-15-TF + VEG-10-15-TF + MCVEG-10-10 + MCT-70-VEG line example
VEG-10-15-TF + VEG-10-15-TF + MCVEG-10-10 + MCT-70-VEG exemple de ligne

Ver características técnicas en página 74 / See technical data in page 74 / Voir caractéristiques techniques page 74

Modelo Model Modèle	Largo Length Longueur (mm)	Superficie de exposición Display area Surface d'exposition (m²)	Superficie total de exposición (TDA) Total display area (TDA) Surface totale de l'exposition (TDA) (m²)	Cámara VE Storage VE Stockage VE (lts)	Puertas Doors Portes (Uds)	Potencia frig. Frig. Power Puissance frig. (W)	Consumo Nominal Nominal power Consommation nominale (W)	Refrigerante Coolant Réfrigérant
VEG-10-10-TF	1025	0,63	0,60	192	1	565	844	R-290
VEG-10-13-TF	1265	0,80	0,75	243	2	572	922	R-290
VEG-10-15-TF	1505	0,96	0,90	294	2	781	1044	R-290
VEG-10-20-TF	1985	1,28	1,21	395	3	1098	1290	R-290

*Modelos en HFC, consultar precio / HFC Models, consult prices / Modèles HFC, consulter prix
230v 60Hz / 115v 60Hz. consultar - consult - consulter

PVP de opcionales incluidos en equipo, no como repuesto / PVP of options included in the equipment, not as a spare part / PVP d'options incluses dans l'équipement, pas en tant que pièce de rechange

OPCIONES · OPTIONS · OPTIONS

Modelo Model Modèle	Cierre Plexi Plexi slide Kit vitrage plexi
VEG-10-10-TF	118 €
VEG-10-13-TF	173 €
VEG-10-15-TF	201 €
VEG-10-20-TF	252 €

Características técnicas y constructivas sujetas a variación sin previo aviso. / We reserve the right to change specifications without prior notice. / Sujet technique et la conception de modifications sans préavis.



VEG-10-20-TF



VEG-10-15-TF

Laterales incluidos en PVP / Sides included in PVP / Latéraux inclus dans PVP

VEG-10-10-TF 2.914 €	VEG-10-13-TF 3.245 €	VEG-10-15-TF 3.543 €	VEG-10-20-TF 4.132 €

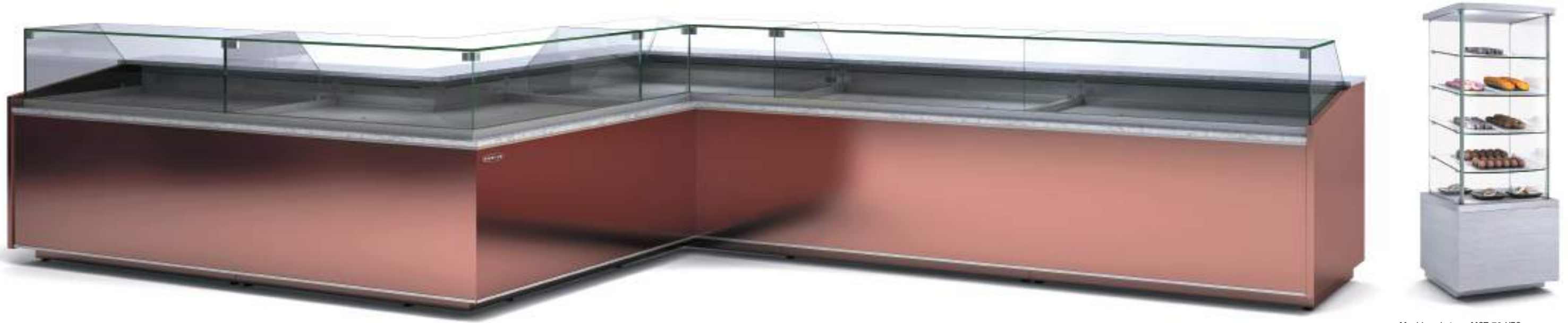

Mueble caja torre MCT-70-VEG
 Cash neutral counter tower MCT-70-VEG
 Meuble caisse tour MCT-70-VEG

Laterales incluidos en PVP / Sides included in PVP / Latéraux inclus dans PVP

Ver características técnicas en página 74 / See technical data in page 74 / Voir caractéristiques techniques page 74

CARACTERÍSTICAS TÉCNICAS ÁNGULOS REFRIGERADOS	REFRIGERATED ANGLE TECHNICAL DATA	CARACTÉRISTIQUES TECHNIQUES DES ANGLES RÉFRIGÉRÉS
<ul style="list-style-type: none"> Sistema de evaporación ventilado Todos los modelos sin puerta de reserva 	<ul style="list-style-type: none"> Ventilated evaporation system All door models without reservation 	<ul style="list-style-type: none"> Système d'évaporation ventilé Tous les modèles sans portes de réserve



230v 60Hz / 115v 60Hz. consultar - consult - consulter

*Modelos en HFC, consultar precio / HFC Models, consult prices / Modèles HFC, consulter prix

PVP de opcionales incluidos en equipo, no como repuesto / PVP of options included in the equipment, not as a spare part / PVP d'options incluses dans l'équipement, pas en tant que pièce de rechange

OPCIONES · OPTIONS · OPTIONS	
Modelo	Cierre Plexi
Model	Plexi slide
Modèle	Kit vitrage plexi
VEG-10-RP90	271 €
VEG-10-RN90	271 €

Características técnicas y constructivas sujetas a variación sin previo aviso / We reserve the right to change specifications without prior notice / Sujet technique et la conception de modifications sans préavis

CARACTERÍSTICAS TÉCNICAS MUEBLES CAJAS	CASH NEUTRAL COUNTER DATA	CARACTÉRISTIQUES TECHNIQUES DES MEUBLE CAISSE
<ul style="list-style-type: none"> Todos los modelos con cajón incorporado, estantes y enchufe Modelo MCVEG-DIS frontal adaptado a discapacitados Modelo MCVEG frontal recto 	<ul style="list-style-type: none"> All models with built-in drawer, shelves and plug Front MCVEG-DIS model adapted for the disabled Straight front MCVEG model 	<ul style="list-style-type: none"> Tous les modèles avec tiroir intégré, étagères et prise Modèle avant MCVEG-DIS adapté aux handicapés Modèle MCVEG à façade droite

CARACTERÍSTICAS TÉCNICAS MUEBLES CAJAS MCT	CASH NEUTRAL COUNTER DATA MCT	CARACTÉRISTIQUES TECHNIQUES DES MEUBLE CAISSE MCT
<ul style="list-style-type: none"> Exterior en madera MDF hidrofuga según color Interior en acero prepintado 4 Estantes de cristal regulables en inclinación De serie: Luz vertical LED Gran visibilidad de producto, laterales y frontal acristalados Lacado según color RAL 	<ul style="list-style-type: none"> MDF wood exterior water leak according to color Prepainted steel interior 4 Glass shelves adjustable in inclination Standard: LED vertical light High product visibility, side and front glazing Lacquered according to RAL color 	<ul style="list-style-type: none"> Bois extérieur MDF repoussant par couleur Prépeinte intérieur acier 4 tablettes en verre réglables en inclinaison Série: lumière verticale LED Grande visibilité du produit, côté frontal et vitrés Laqué selon RAL

DETALLE DETAIL / DETAIL	MUEBLES CAJA NEUTROS NEUTRAL CASH COUNTER / MEUBLE CAISSE NEUTRE	
	MCVEG-10-10-DIS 1.538 €	MCT-70-VEG 1.968 €
	MCVEG-10-10 1.538 €	

Modelo Modèle	Largo Longueur (mm)	Alto Height Hauteur (mm)	Fondo Depth Profondeur (mm)	Superficie de exposición Display area Surface d'exposition (m²)	Superficie total de exposición (TDA) Total display area (TDA) Surface totale de l'exposition (TDA) (m²)	Cámara VE Storage VE Stockage VE (m³)	Puertas Doors Portes (Uds)	Potencia frig. Frig. Power Puissance frig. (W)	Consumo Consumption Consommation (W)	Refrigerante Coolant Réfrigérant
VEG-10-RN90	1440	1085	1440	1,14	0,9	-	0	583	926	R-290
VEG-10-RP90	1430	1085	1430	1,21	1,28	-	0	583	957	R-290
MCVEG-10-10	1000	900	1030	0,92	-	-	-	-	-	
MCT-70-VEG	700	1850	700	1,68	-	-	-	-	24	



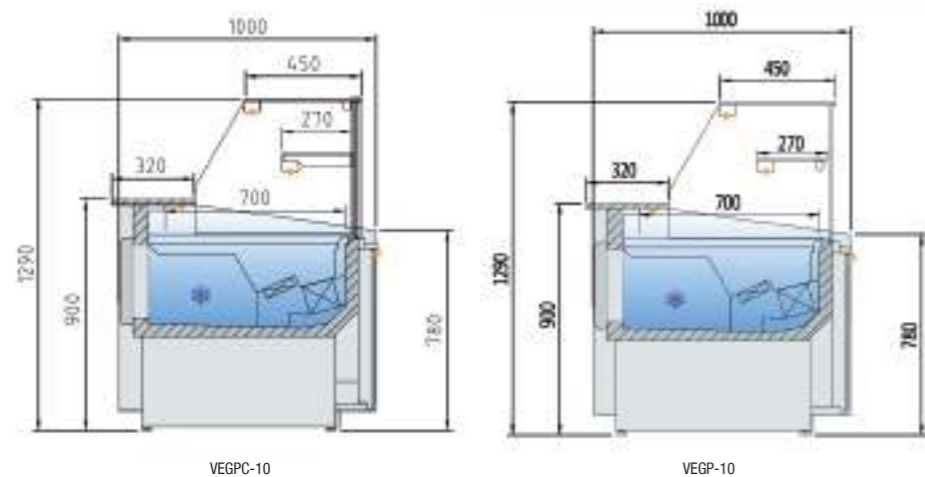

Detalle VEGP
VEGP detail
Detail VEGP



VITRINA EXPOSITORA MODULAR PASTELERA VEGPC / VEGP-10
SERVE OVER COUNTER MODULAR BAKERY VEGPC/VEGP-10 · VITRINE SERIE VEGPC/VEGP-10 GAMME MODULAIRE PATISSERIE

□□□□□ 4000K ●●●●● 3000K



VEGPC-10-20-TF



Detalle interior + encimera trabajo color negro (Consultar)
Interior detail + black work countertop (Consult)
Détail intérieur + plan de travail noir (Consulter)



VEGP-10-15-TF

Ver características técnicas en página 74 / See technical data in page 74 / Voir caractéristiques techniques page 74

Modelo Model Modèle	Largo Length Longueur (mm)	Superficie de exposición Display area Surface d'exposition (m²)	Superficie total de exposición (TDA) Total display area (TDA) Surface totale de l'exposition (TDA) (m²)	Cámara VE Storage VE Stockage VE (lbs.)	Puertas Doors Portes (Uds)	Potencia frig. Frig. Power Puissance frig. (W)	Consumo Nominal Nominal power Consommation nominale (W)	Refrigerante Coolant Réfrigérant
VEGP / VEGPC-10-10-TF	1025	0,82	0,60	192	1	565	844	R-290
VEGP / VEGPC-10-13-TF	1265	1,03	0,75	243	2	572	922	R-290
VEGP / VEGPC-10-15-TF	1505	1,24	0,90	294	2	781	1044	R-290
VEGP / VEGPC-10-20-TF	1985	1,66	1,21	395	3	1098	1290	R-290

*Modelos en HFC, consultar precio / HFC Models, consult prices / Modèles HFC, consulter prix

230v 60Hz / 115v 60Hz, consultar - consult - consulter

PVP de opcionales incluidos en equipo, no como repuesto / PVP of options included in the equipment, not as a spare part / PVP d'options incluses dans l'équipement, pas en tant que pièce de rechange

OPCIONES · OPTIONS · OPTIONS

Modelo Model Modèle	Cierre Plexi Plexi slide Kit vitrage plexi
VEGP / VEGPC-10-10-TF	118 €
VEGP / VEGPC-10-13-TF	173 €
VEGP / VEGPC-10-15-TF	201 €
VEGP / VEGPC-10-20-TF	252 €

Características técnicas y constructivas sujetas a variación sin previo aviso. / We reserve the right to change specifications without prior notice. / Sujet technique et la conception de modifications sans préavis.

Laterales incluidos en PVP / Sides included in PVP / Latéraux inclus dans PVP

VEGP-10-10-TF 3.060 €	VEGP-10-13-TF 3.407 €	VEGP-10-15-TF 3.720 €	VEGP-10-20-TF 4.339 €
VEGPC-10-10-TF 3.632 €	VEGPC-10-13-TF 4.045 €	VEGPC-10-15-TF 4.592 €	VEGPC-10-20-TF 5.198 €

□□□□□ □□□□□
 4000K 3000K



Mueble caja torre MCT-70-VEG
 Cash neutral counter tower MCT-70-VEG
 Meuble caisse tour MCT-70-VEG

Laterales incluidos en PVP / Sides included in PVP / Latéraux inclus dans PVP

Ver características técnicas en página 74 / See technical data in page 74 / Voir caractéristiques techniques page 74

CARACTERÍSTICAS TÉCNICAS ÁNGULOS REFRIGERADOS	REFRIGERATED ANGLE TECHNICAL DATA	CARACTÉRISTIQUES TECHNIQUES DES ANGLES RÉFRIGÉRÉS
<ul style="list-style-type: none"> Sistema de evaporación ventilado Todos los modelos sin puerta de reserva 	<ul style="list-style-type: none"> Ventilated evaporation system All door models without reservation 	<ul style="list-style-type: none"> Système d'évaporation ventilé Tous les modèles sans portes de réserve

CARACTERÍSTICAS TÉCNICAS MUEBLES CAJAS	CASH NEUTRAL COUNTER DATA	CARACTÉRISTIQUES TECHNIQUES DES MEUBLE CAISSE
<ul style="list-style-type: none"> Todos los modelos con cajón incorporado, estantes y enchufe Modelo MCVEG-DIS frontal adaptado a discapacitados Modelo MCVEG frontal recto 	<ul style="list-style-type: none"> All models with built-in drawer, shelves and plug Front MCVEG-DIS model adapted for the disabled Straight front MCVEG model 	<ul style="list-style-type: none"> Tous les modèles avec tiroir intégré, étagères et prise Modèle avant MCVEG-DIS adapté aux handicapés Modèle MCVEG à façade droite

CARACTERÍSTICAS TÉCNICAS MUEBLES CAJAS MCT	CASH NEUTRAL COUNTER DATA MCT	CARACTÉRISTIQUES TECHNIQUES DES MEUBLE CAISSE MCT
<ul style="list-style-type: none"> Exterior en madera MDF hidrofuga según color Interior en acero prepintado 4 Estantes de cristal regulables en inclinación De serie: Luz vertical LED Gran visibilidad de producto, laterales y frontal acristalados Lacado según color RAL 	<ul style="list-style-type: none"> MDF wood exterior water leak according to color Prepainted steel interior 4 Glass shelves adjustable in inclination Standard: LED vertical light High product visibility, side and front glazing Lacquered according to RAL color 	<ul style="list-style-type: none"> Bois extérieur MDF repoussant par couleur Prépeinte intérieur acier 4 tablettes en verre réglables en inclinaison Série: lumière verticale LED Grande visibilité du produit, côté frontal et vitrés Laqué selon RAL

VEGP / VEGPC-10-RN90 **7.106 €**

VEGP / VEGPC-10-RP90 **6.673 €**

230v 60Hz / 115v 60Hz. consultar - consult - consulter

PVP de opcionales incluidos en equipo, no como repuesto / PVP of options included in the equipment, not as a spare part / PVP d'options incluses dans l'équipement, pas en tant que pièce de rechange

OPCIONES · OPTIONS · OPTIONS	
Modelo	Cierre Plexi
Model	Plexi slide
Modèle	Kit vitrage plexi
VEGPC-10-RP90	271 €
VEGPC-10-RN90	271 €

DETALLE DETAIL / DETAIL	MUEBLES CAJA NEUTROS NEUTRAL CASH COUNTER / MEUBLE CAISSE NEUTRE
<p>MCVEG-10-10-DIS 1.538 €</p> <p>MCVEG-10-10 1.538 €</p>	<p>MCT-70-VEG 1.968 €</p>

Modelo Modèle	Largo Longueur (mm)	Alto Height Hauteur (mm)	Fondo Depth Profondeur (mm)	Superficie de exposición Display area Surface d'exposition (m²)	Superficie total de exposición (TDA) Total display area (TDA) Surface totale de l'exposition (TDA) (m²)	Cámara VE Storage VE Stockage VE (m³)	Puertas Doors Portes (Uds)	Potencia frig. Frig. Power Puissance frig. (W)	Consumo Consumption Consommation (W)	Refrigerante Coolant Réfrigérant
VEG-10-RN90	1440	1085	1440	1,14	0,9	-	0	583	926	R-290
VEG-10-RP90	1430	1085	1430	1,21	1,28	-	0	583	957	R-290
MCVEG-10-10	1000	900	1030	0,92	-	-	-	-	-	-
MCT-70-VEG	700	1850	700	1,68	-	-	-	-	24	-

Características técnicas y constructivas sujetas a variación sin previo aviso / We reserve the right to change specifications without prior notice / Sujet technique et la conception de modifications sans préavis

□□□□□ □□□□□
4000K 3000K



Detalle estante alto MP-EA
High shelf detail MP-EA
Détail de la tablette haute MP-EA



Detalle cajon extraíble
Removable drawer detail
Détail de tiroir amovible



Detalle espejo e iluminación superior
(Incluido en PVP)
Mirror detail and top lighting
(Included in PVP)
Détail de miroir et éclairage supérieur
(Inclus dans PVP)

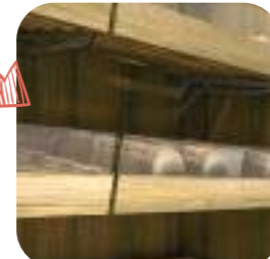

Detalle estante bajo MP-EB
Bottom shelf detail MP-EB
Détail de la tablette basse MP-EB



Módulo bajo con puertas
Low module with doors
Module bas avec portes

Decoración lacado RAL a elegir mismo precio
RAL lacquered decoration to choose same price
Décoration laquée RAL au même prix



Modelo Model Modèle	Largo Length Longueur (mm)	Alto Height Hauteur (mm)	Fondo Depth Profondeur (mm)	Consumo Consumption Consommation (W)
Módulo Panero MPM-800	830	2300	600	23
Módulo Panero MPM-1600	1630	2300	600	46
Módulo Panero MPM-2400	2440	2300	600	70
Módulo Estante alto MP-EA	785	200	485	-
Módulo Estante bajo MP-EB	785	80	485	-
Encimera granito módulo bajo MP-EMB	800	20	560	-
Módulo bajo 2P MPMB-2P	800	695	560	-
Módulo bajo 1C MPMB-1C	800	600	560	-

230v 60Hz / 115v 60Hz. consultar - consult - consulter
Características técnicas y constructivas sujetas a variación sin previo aviso. / We reserve the right to change specifications without prior notice. / Sujet technique et la conception de modifications sans préavis.

 MP-EA 261 €	 MP-EMB 140 €	 MPMB-2P 832 €	 MPMB-1C 1.105 €
 MPM-800 1.187 €	 MPM-1600 2.261 €	 MPM-2400 3.070 €	 MP-EB 227 €

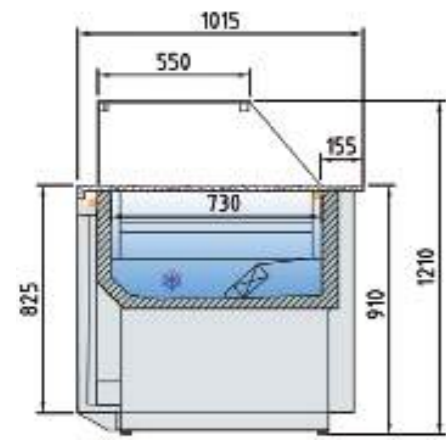

Detalle plano de exposición regulable
Adjustable shelves detail
Détailé l'exposition réglable

4000K 3000K

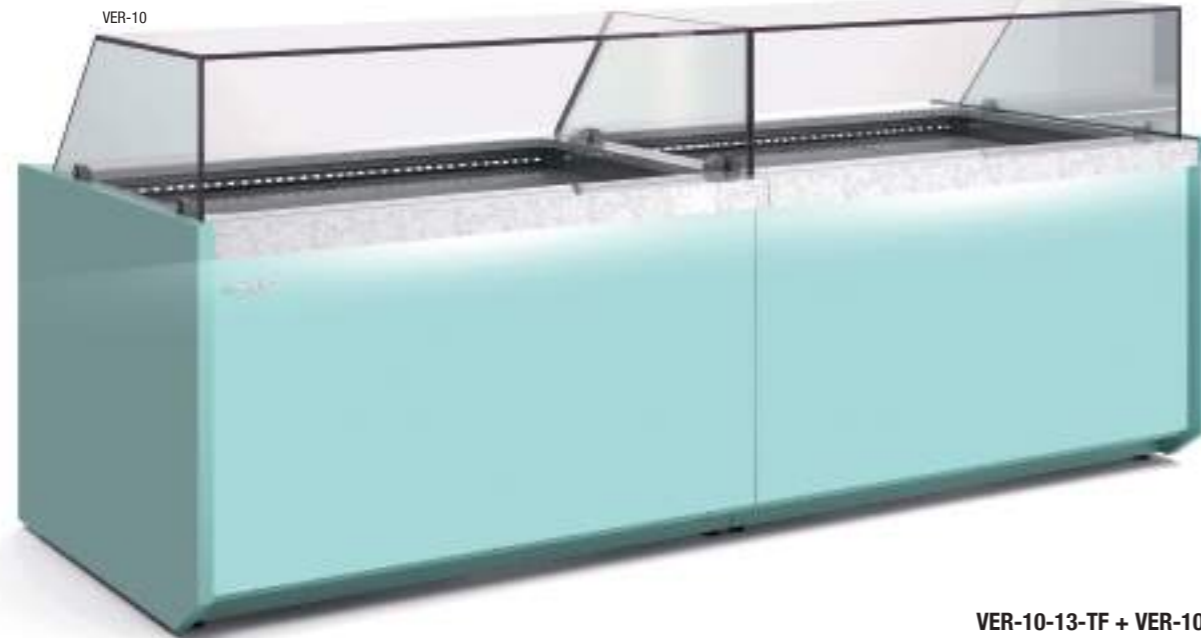

VER-10-13-TF + VER-10-13-TF

VER-10-13-TF

Modelo Model Modèle	Largo Length Longueur (mm)	Superficie de exposición Display area Surface d'exposition (m ²)	Superficie total de exposición (TDA) Total display area (TDA) Surface totale de l'exposition (TDA) (m ²)	Puertas Doors Portes (Uds)	Potencia frig. Frig. Power Puissance frig. (W)	Consumo Nominal Nominal power Consommation nominale (W)	Refrigerante Coolant Réfrigérant
VER-10-10-TF	1025	0,61	0,57	-	565	844	R-290
VER-10-13-TF	1265	0,77	0,72	-	572	922	R-290
VER-10-15-TF	1505	0,94	0,88	-	781	1044	R-290
VER-10-20-TF	1985	1,27	1,19	-	1098	1290	R-290

*Modelos en HFC, consultar precio / HFC Models, consult prices / Modèles HFC, consulter prix

PVP de opcionales incluidos en equipo, no como repuesto / PVP of options included in the equipment, not as a spare part / PVP d'options incluses dans l'équipement, pas en tant que pièce de rechange

OPCIONES · OPTIONS · OPTIONS	
Modelo	Cierre Plexi
Model	Plexi slide
Modèle	Kit vitrage plexi
VER-10-10-TF	118 €
VER-10-13-TF	173 €
VER-10-15-TF	201 €
VER-10-20-TF	252 €

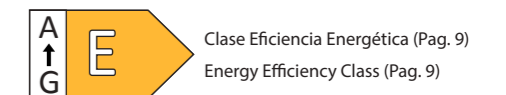

Clase Eficiencia Energética (Pag. 9)
Energy Efficiency Class (Pag. 9)

Laterales incluidos en PVP / Sides included in PVP / Latéraux inclus dans PVP

VER-10-10 TF 3.120 €	VER-10-13 TF 3.474 €	VER-10-15 TF 3.793 €	VER-10-20 TF 4.790 €

Características técnicas y constructivas sujetas a variación sin previo aviso. / We reserve the right to change specifications without prior notice. / Sujet technique et la conception de modifications sans préavis.

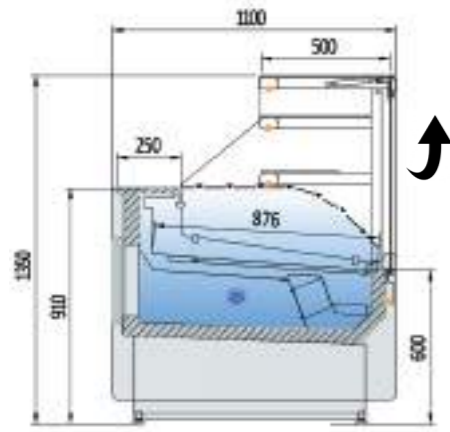

VEPR-10E-RC-TF

CARACTERÍSTICAS TÉCNICAS GENERALES

- Exterior e interior en chapa de acero plastificada
- Plano exposición y encimera en acero inox. AISI-304
- Dos estantes de cristal intermedio iluminado, no refrigerado
- Cristal frontal elevable recto
- Iluminación estándar: encimera superior y estantes LED
- Reserva refrigerada con puertas, hueco 440x270
- Evaporador tratado epoxy
- Condensación ventilada y evaporación automática de serie
- Modelos preinstalación incorporan valvulería solenoide y expansión en R-449A, opción R-134a
- Control electrónico de temperatura
- Descarche automático, opcional eléctrico
- Clase climática 4 (30°C 55%RH) régimen M1 según UNE-EN ISO 23953-2
- Chasis en acero acabado epoxy
- Tensión de trabajo monofásica 220V 50Hz

GENERAL TECHNICAL DATA

- Exterior and interior in plasticized steel sheet
- Exposure plan and countertop in stainless steel. AISI-304
- Two illuminated, non-refrigerated middle glass shelves
- Straight lift-up front glass
- Standard lighting: top worktop and LED shelves
- Refrigerated storage with doors, hollow 440x270
- Epoxy treated evaporator
- Ventilated condensation and automatic evaporation as standard
- Pre-installation models incorporate solenoid valves and expansion in R-449A, option R-134a
- electronic temperature control
- Automatic defrost, optional electric
- Climate class 4 (30°C 55%RH) regime M1 according to UNE-EN ISO 23953-2
- Epoxy finished steel chassis
- Single-phase working voltage 220V 50Hz

CARACTÉRISTIQUES TECHNIQUES GÉNÉRAL

- Extérieur et intérieur en tôle d'acier plastifié
- Plan d'exposition et plan de travail en inox. AISI-304
- Deux étagères centrales en verre éclairées et non réfrigérées
- Vitre frontale relevable droite
- Eclairage standard : plan de travail supérieur et étagères LED
- Entrepôt réfrigéré avec portes, creux 440x270
- Évaporateur traité époxy
- Condensation ventilée et évaporation automatique de série
- Les modèles de pré-installation intègrent des électrovannes et une expansion au R-449A, option R-134a
- contrôle électronique de la température
- Dégivrage automatique, électrique en option
- Classe climatique 4 (30°C 55%HR) régime M1 selon UNE-EN ISO 23953-2
- Châssis en acier finition époxy
- Tension de travail monophasée 220V 50Hz

4000K 3000K

VITRINA EXPOSITORA MODULAR PASTELERA VEPR-10

SERVE OVER COUNTER MODULAR BAKERY LINE VEPR-10 · VITRINE SERIE VEPR-10 GAMME MODULAIRE PATISSERIE



VEPR-10-20-TF

Modelo Model Modèle	Largo Length Longueur (mm)	Superficie de exposición Display area Surface d'exposition (m²)	Superficie total de exposición (TDA) Total display area (TDA) Surface totale de l'exposition (TDA) (m²)	Cámara VE Storage VE Stockage VE (lts.)	Puertas Doors Portes (Uds)	Potencia frig. Frig. Power Puissance frig. (W)	Consumo Nominal Nominal power Consommation nominale (W)	Refrigerante Coolant Réfrigérant
VEPR-10E-10-RC-TF	1025	0,80	0,91	293	1	565	851	R-290
VEPR-10E-13-RC-TF	1265	1,00	1,13	369	2	572	912	R-290
VEPR-10E-15-RC-TF	1505	1,21	1,36	444	2	781	1046	R-290
VEPR-10E-20-RC-TF	1985	1,61	1,81	594	3	1098	1290	R-290
VEPR-10E-25-RC-TF	2465	2,01	2,26	745	4	1284	1354	R-290
VEPR-10E-30-RC-TF	2945	2,41	2,71	896	4	1284	1378	R-290

*Modelos en HFC, consultar precio / HFC Models, consult prices / Modèles HFC, consulter prix

230v 60Hz / 115v 60Hz. consultar - consult - consulter

PVP de opcionales incluidos en equipo, no como repuesto / PVP of options included in the equipment, not as a spare part / PVP d'options incluses dans l'équipement, pas en tant que pièce de rechange

OPCIONES · OPTIONS · OPTIONS

Modelo Model Modèle	1 decoración frontal / front decor / décoration frontale	2 Total decoración / Total decor / déco- ration total	Cierre Plexi Plexi slide Kit vitrage plexi	Iluminación led extra Extra led lighting Éclairage Led extra	Neutra Neutral Neutre	Pre Instalación Remote Unit Groupe à distance
VEPR-10E-10-RC-TF	140 €	460 €	118 €	57 €	-410 €	-120 €
VEPR-10E-13-RC-TF	150 €	471 €	173 €	78 €	-460 €	-135 €
VEPR-10E-15-RC-TF	164 €	481 €	201 €	93 €	-510 €	-145 €
VEPR-10E-20-RC-TF	174 €	489 €	252 €	112 €	-615 €	-180 €
VEPR-10E-25-RC-TF	184 €	495 €	335 €	148 €	-870 €	-205 €
VEPR-10E-30-RC-TF	194 €	502 €	397 €	160 €	-995 €	-255 €

Características técnicas y constructivas sujetas a variación sin previo aviso. / We reserve the right to change specifications without prior notice. / Sujet technique et la conception de modifications sans préavis.

Laterales incluidos en PVP / Sides included in PVP / Latéraux inclus dans PVP

VEPR-10E-10-RC-TF 4.397€	VEPR-10E-13-RC-TF 4.701€	VEPR-10E-15-RC-TF 5.170€	VEPR-10E-20-RC-TF 6.057€	VEPR-10E-25-RC-TF 7.282€	VEPR-10E-30-RC-TF 7.893€



CARACTERÍSTICAS TÉCNICAS

- Exterior e interior en chapa de acero plastificada
- Plano exposición y encimera en acero inox. AISI-304
- Costados de 30 mm en ABS inyectado
- Perfilera en aluminio anodizado.
- Paragolpes en la parte delantera
- Cristal frontal templado y elevable curvo o recto
- Estante de cristal intermedio, opcional
- Iluminación estándar: encimera superior LED
- Aislamiento de poliuretano inyectado, densidad 40 Kg/m³, bajo GWP y cero efecto ODP
- Reserva refrigerada con puertas, hueco 440x270 (excepto modelo neutro y modelo sin reserva)
- Evaporador ventilado.
- Condensación ventilada, evaporación automática de serie
- Control electrónico de temperatura
- Descarche automático, opcional eléctrico
- Clase climática 4 (30 °C 55% Hr) régimen M1 según UNE-EN ISO 23953-2
- Chasis en acero acabado epoxi
- Tensión de trabajo monofásica 220V 50Hz

TECHNICAL DATA

- Exterior and interior finish in plastic coated steel
- Display area and counter in stainless steel AISI-304
- Sides 30 mm injected ABS
- Profiles in anodized aluminum.
- Front rubber bumper
- Toughened and liftable curved or straight front glass
- Intermediate glass shelf, optional
- Standard lighting: counter top LED
- Injected polyurethane insulation, density 40 Kg/m³, low GWP and zero ODP effect
- Refrigerated under storage with doors 440x270 (except neutral model and model without reservation)
- Ventilated evaporator.
- Condensation ventilated, automatic defrost evaporation of as standar
- Electronic temperature control
- Automatic electric defrost, optional
- Climatic class 4 (30 °C 55% Hr) regime M1 according to UNE-EN ISO 23953-2
- Working voltage single phase 220V 50Hz
- Chassis in epoxy finished steel

CARACTÉRISTIQUES TECHNIQUES

- Extérieur et intérieur en tôle d'acier plastifié chaque
- Exposition Plano et comptoir en acier inoxydable. AISI-304
- Côtés 30 mm ABS injecté
- Profils en aluminium anodisé.
- Sur le pare-chocs avant
- Trempé et verre de levage avant courbe ou droite
- Étagère en verre intermédiaire, en option
- Eclairage standard: comptoir LED
- Isolation en polyuréthane injecté, densité 40 kg/m³, faible GWP et ODP nul effet
- Réserver refroidi portes, creux 440x270 (sauf modèle neutre et le modèle sans réserve)
- Évaporateur ventilé.
- De la condensation ventilé, évaporation automatique de série
- Contrôle électronique de la température
- Dégivrage électrique automatique, en option
- Classe climatique 4 (30 °C 55% Hr) régime M1 selon UNE-EN ISO 23953-2
- Tension de fonctionnement monphasé 220V 50Hz
- Châssis en acier fini époxy



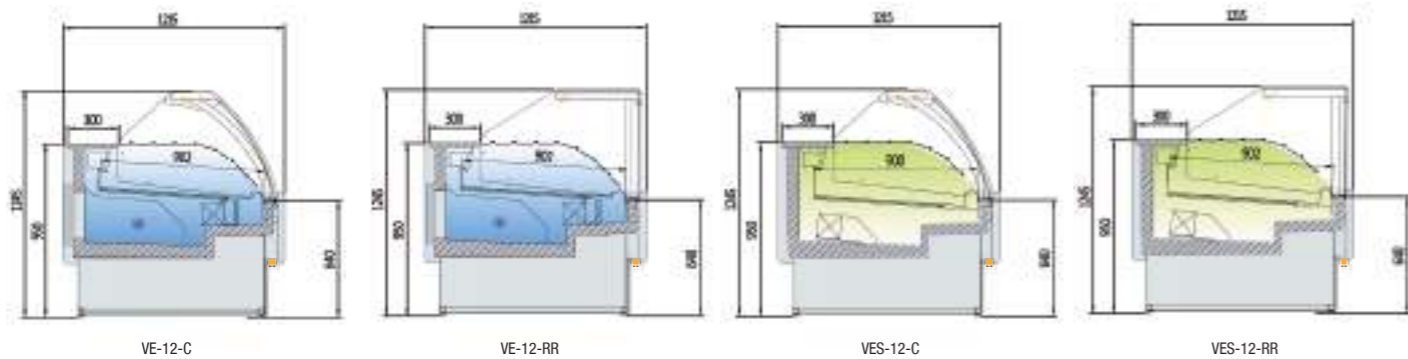

4000K 3000K RED FRESH



MODELOS CON RESERVA / MODELS WITH RESERVATION / RÉSERVE MODÈLES

MODELOS SIN RESERVA / MODELS WITHOUT RESERVATION / RÉSERVE SANS MODÈLES



Detalle cristal elevable
Liftable glass detail
Detail vitree elevable



Detalle repetidor temperatura
Display temperature detail
Detail température repeater

Ver características técnicas en página 92 / See technical data in page 92 / Voir caractéristiques techniques page 92

Modelo Model Modèle	Largo Length Longueur (mm)	Superficie de exposición Display area Surface d'exposition (m²)	Superficie total de exposición (TDA) Total display area (TDA) Surface totale de l'exposition (TDA) (m²)		Cámara VE Storage VE Stockage VE (lts.)	Puertas Doors Portes (Uds)	Potencia frig. Frig. Power Puissance frig. (W)	Consumo Nominal Nominal power Consommation nominale (W)	Refrigerante Coolant Réfrigérant
			(C)	(RR)					
VE / VES-12-10-TF	997	1,05	1	1,29	520	2 / 0	949	1054	R-290
VE / VES-12-13-TF	1310	1,05	1	1,29	520	2 / 0	949	1054	R-290
VE / VES-12-15-TF	1623	1,31	1,25	1,61	600	2 / 0	1012	1105	R-290
VE / VES-12-20-TF	1935	1,57	1,50	1,93	810	3 / 0	1419	1379	R-290
VE / VES-12-25-TF	2560	2,10	2	2,58	1100	4 / 0	1703	1417	R-290
VE / VES-12-30-TF	3185	2,62	2,5	3,22	1280	5 / 0	1931	1689	R-290
VE / VES-12-37-TF	3810	3,14	3,01	3,87	1620	6 / 0	2838	2136	R-290

230v 60Hz / 115v 60Hz. consultar - consult - consulter

*Modelos en HFC, consultar precio / HFC Models, consult prices / Modèles HFC, consulter prix

PVP de opcionales incluidos en equipo, no como repuesto / PVP of options included in the equipment, not as a spare part / PVP d'options incluses dans l'équipement, pas en tant que pièce de rechange

Modelo Model Modèle	OPCIONES · OPTIONS · OPTIONS		Cierre Plexi Plexi slide Kit vitrage plexi	Iluminación led extra Extra led lighting Éclairage Led extra	Cierre cortina Night blind Rideau nocturne	Neutra Neutral Neutre	Pre Instalación Remote Unit Groupe à distance
	1 decoración frontal / front decor / décoration frontal	2 Total decoración / Total decor / décoration total					
VE / VES-12-10-TF	140 €	460 €	118 €	57 €	175 €	-410 €	-120 €
VE / VES-12-13-TF	150 €	471 €	173 €	78 €	242 €	-460 €	-135 €
VE / VES-12-15-TF	164 €	481 €	201 €	93 €	292 €	-510 €	-145 €
VE / VES-12-20-TF	174 €	489 €	252 €	112 €	321 €	-615 €	-180 €
VE / VES-12-25-TF	184 €	495 €	335 €	148 €	378 €	-870 €	-205 €
VE / VES-12-30-TF	194 €	502 €	397 €	160 €	581 €	-995 €	-255 €
VE / VES-12-37-TF	275 €	780 €	500 €	222 €	640 €	-1.050 €	-310 €

Características técnicas y constructivas sujetas a variación sin previo aviso. / We reserve the right to change specifications without prior notice. / Sujet technique et la conception de modifications sans préavis.



VE-12-20-C-TF



VE-12-25-RR-TF

Clase Eficiencia Energética (Pag. 9)
Energy Efficiency Class (Pag. 9)

Laterales incluidos en PVP / Sides included in PVP / Latéraux inclus dans PVP

VE-12-10-C-TF	4.191 €	VE-12-13-C-TF	4.587 €	VE-12-15-C-TF	4.930 €	VE-12-20-C-TF	5.457 €	VE-12-25-C-TF	6.506 €	VE-12-30-C-TF	7.305 €	VE-12-37-C-TF	8.910 €
VES-12-10-C-TF	4.042 €	VES-12-13-C-TF	4.470 €	VES-12-15-C-TF	4.862 €	VES-12-20-C-TF	5.263 €	VES-12-25-C-TF	6.303 €	VES-12-30-C-TF	6.965 €	VES-12-37-C-TF	8.480 €
VE-12-10-RR-TF	4.272 €	VE-12-13-RR-TF	4.631 €	VE-12-15-RR-TF	5.074 €	VE-12-20-RR-TF	5.588 €	VE-12-25-RR-TF	6.701 €	VE-12-30-RR-TF	7.320 €	VE-12-37-RR-TF	9.215 €
VES-12-10-RR-TF	4.160 €	VES-12-13-RR-TF	4.470 €	VES-12-15-RR-TF	4.955 €	VES-12-20-RR-TF	5.390 €	VES-12-25-RR-TF	6.363 €	VES-12-30-RR-TF	7.137 €	VES-12-37-RR-TF	8.130 €

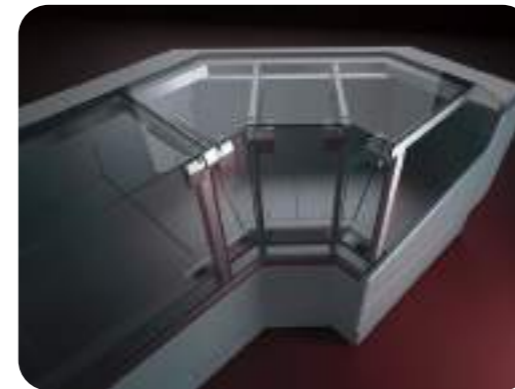

Laterales incluidos en PVP / Sides included in PVP / Latéraux inclus dans PVP

Ver características técnicas en página 92 / See technical data in page 92 / Voir caractéristiques techniques page 92

CARACTERÍSTICAS TÉCNICAS ÁNGULOS REFRIGERADOS

- Sistema de evaporación ventilado
- VES vitrina sin reserva
- VE vitrina con reserva
- **C:** Cristal curvo
- **RR:** Cristal doble recto
- Todos los modelos sin puerta de reserva

REFRIGERATED ANGLE TECHNICAL DATA

- Ventilated evaporation system
- VES without storage
- VE with storage
- **C:** Curved glass
- **RR:** Double flat glass
- All door models without reservation

CARACTÉRISTIQUES TECHNIQUES DES ANGLES RÉFRIGÉRÉS

- Système d'évaporation ventilé
- VES sans stockage
- VE stockage
- **C:** Vitre bombée
- **RR:** Vitre double droit
- Tous les modèles sans portes de réserve

CARACTERÍSTICAS TÉCNICAS MUEBLES CAJAS

- Todos los modelos con cajón incorporado, estantes y enchufe
- Modelo MCVE frontal recto

CASH NEUTRAL COUNTER DATA

- All models with built-in drawer, shelves and plug
- Straight front MCVE model

CARACTÉRISTIQUES TECHNIQUES DES MEUBLE CAISSE

- Tous les modèles avec tiroir intégré, étagères et prise
- Modèle MCVE à façade droite

Modelo DIS consultar / DIS model consult / Modelé DIS consulter

MUEBLES CAJA NEUTROS
 CASH NEUTRAL COUNTER / MEUBLE CAISSE NEUTRE

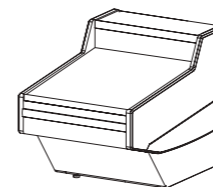

MCVE-12-8 **1.415 €**

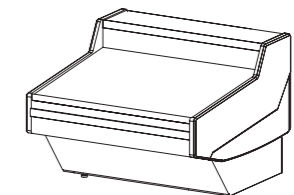

MCVE-12-12 **1.548 €**

VE-12-AN90-RR 9.233 €	VES-12-AN90-RR 9.233 €	VE-12-AP90-C 7.380 €	VES-12-AP90-C 7.380 €
		VE-12-AP90-RR 7.235 €	VES-12-AP90-RR 7.235 €

230v 60Hz / 115v 60Hz. consultar - consult - consulter

*Modelos en HFC, consultar precio / HFC Models, consult prices / Modèles HFC, consulter prix

PVP de opcionales incluidos en equipo, no como repuesto / PVP of options included in the equipment, not as a spare part / PVP d'options incluses dans l'équipement, pas en tant que pièce de rechange

OPCIONES · OPTIONS · OPTIONS

Modelo / Model / Modèle	1 decoración frontal / front decor / décoration frontal	2 Total decoración / Total decor / décoration total	Cierre Plexi / Plexi slide / Kit vitrage plexi
VE/VES-12-AP90	 156 €	 502 €	271 €
VE/VES-12-AN90	156 €	502 €	271 €

Características técnicas y constructivas sujetas a variación sin previo aviso / We reserve the right to change specifications without prior notice / Sujet technique et la conception de modifications sans préavis

Modelo / Model / Modèle	Largo / Length / Longueur (mm)	Alto / Height / Hauteur (mm)	Fondo / Depth / Profondeur (mm)	Superficie de exposición / Display area / Surface d'exposition (m²)	Superficie total de exposición (TDA) / Total display area (TDA) / Surface totale de l'exposition (TDA) (m²)	Cámara VE / Storage VE / Stockage VE (m²)	Puertas / Doors / Portes (Uds)	Potencia frig. / Frig. Power / Puissance frig. (W)	Consumo / Consumption / Consommation (W)	Refrigerante / Coolant / Réfrigérant
VE/VES-12-AN90	1565	1230	1565	1,27	0,84 / 1,12	-	0	949	1076	R-290
VE/VES-12-AP90	1565	1230	1565	1,31	1,35 / 1,70	-	0	781	1012	R-290
VE/VES-12N-AN45	800	940	1215	0,78	- / -	-	-	-	-	-
VE/VES-12N-AP45	1200	940	1215	1,21	- / -	-	-	-	-	-

Imagen Picture Image	Descripción Description Description	Gama VE Excepto modelos Saus modeés (ES / BM)	Gama Gamma VEP	Gama Gamma VE-P	Gama Gamma EEC	Gama Gamma VEA	Gama Gamma VE-E	Gama Gamma VEL	Gama Gamma VE-RC	Gama Gamma VE-E-RC VEPR-E-RC	Gama Gamma VEG	Gama Gamma VEGP VEGPC	Gama Gamma VER
	Decoración frontal Front decor Décoration frontale	✓	✓	-	-	✓	✓	✓	✓	✓	-	-	-
	Decoración total Total decor Total frontal	✓	✓	-	-	✓	✓	✓	✓	✓	De serie Standard De serie	De serie Standard De serie	De serie Standard De serie
	Kit de puertas plexi Plexi slide doors Kit coulissant arrière plexi	✓	✓	✓	De serie Standard De serie	-	✓	✓	✓	✓	✓	✓	✓
	Cierre cortina Night blind Rideau de nuit	✓	✓	✓	-	✓	-	✓	✓	✓	-	-	-
	Juego de guías pasteleras (por puerta) Pastry guide set (per door) Jeu de glissières pâtisserie (par porte)	-	✓	-	-	-	-	-	-	-	-	-	-
	Estante adicional intermedio con luz Additional intermediate shelf with light Étagère intermédiaire supplément avec lumière	✓	-	-	-	-	✓	✓	✓	✓	-	-	-
	LED cálida adicional 3000K LED extra warm 3000K LED lumière supplémentaire jaune 3000K	✓	✓	✓	✓	✓	✓	✓	✓	✓	✓	✓	✓
	LED blanco adicional 4000K LED extra white 4000K LED lumière supplémentaire blanc 4000K	✓	✓	✓	✓	✓	✓	✓	✓	✓	✓	✓	✓
	LED adicional Red Fresh LED extra Red Fresh LED lumière supplémentaire Red Fresh	✓	✓	✓	✓	✓	✓	✓	✓	✓	✓	✓	✓
	Cambio led standard 4000K por led cálido 3000K Change standard 4000K LED for warm 3000K LED Remplacement de la LED standard 4000k per une 3000k	✓	✓	✓	✓	✓	✓	✓	✓	✓	✓	✓	✓
	Cambio led standard 4000K por led Red Fresh Change standard 4000K LED for red fresh LED Remplacement de la LED standard 4000k per red fresh	✓	✓	✓	✓	✓	✓	✓	✓	✓	✓	✓	✓
	Cuba en acero inoxidable AISI-316 AISI-316 stainless steel tank Cuve en inox AISI-316	✓	✓	✓	✓	-	-	-	-	-	-	-	-
	Plano de exposición inoxidable AISI-316 AISI-316 stainless steel exhibition table Plan de travail inox AISI-316	-	-	De serie Standard De serie	✓	-	-	-	-	-	-	-	-
	Encimera en cuarzo tecnológico color blanco Stone worktop - compact white Plan de travail en pierre - compact blanc	✓	✓	✓	✓	✓	✓	✓	✓	✓	De serie Standard De serie	De serie Standard De serie	De serie Standard De serie
	Encimera en cuarzo tecnológico color negro Stone worktop - compact black Plan de travail en pierre - granit noir	✓	✓	✓	✓	✓	✓	✓	✓	✓	✓	✓	✓
	Plano de exposición en color blanco Exhibition plan in white Plan d'exposition en couleur blanc	✓	✓	-	-	✓	✓	✓	✓	✓	✓	✓	✓
	Plano de exposición en color negro Exhibition plan in black Plan d'exposition en couleur noir	✓	✓	-	-	✓	✓	✓	✓	✓	✓	✓	✓
	Pies inox 125-200mm (mod. superiores a +2000mm) Inox feet 125-200mm (models greater than +2000mm) Pieds inox 125-200mm (Pour mod. longueur +2000mm)	✓	✓	✓	✓	✓	✓	✓	✓	✓	✓	✓	✓

Imagen Picture Image	Descripción Description Description	Gama VE Excepto modelos Saus modeés (ES / BM)	Gama Gamma VEP	Gama Gamma VE-P	Gama Gamma EEC	Gama Gamma VEA	Gama Gamma VE-E	Gama Gamma VEL	Gama Gamma VE-RC	Gama Gamma VE-E-RC VEPR-E-RC	Gama Gamma VEG	Gama Gamma VEGP VEGPC	Gama Gamma VER
	Kit estantes reserva trasera Rear reserve shelf kit Plancher sous réserve	✓	✓	✓	-	✓	✓	✓	✓	✓	-	-	-
	Plano de exposición con escalón Exhibition plan with step Plan d'exposition double niveau	✓	✓	-	-	✓	✓	✓	✓	✓	-	-	-
	Separador de género Food separator Separateur de réserve	✓	✓	-	-	✓	✓	✓	✓	✓	✓	✓	✓
	Separador de ambiente (Kit de unión) Ambiente food separator (Union kit) Separateur de ambiant (Kit d'union)	✓	✓	-	-	-	✓	✓	✓	✓	✓	✓	✓
	Kit de unión Union kit Kit d'union	✓	✓	✓	-	✓	✓	✓	✓	✓	✓	✓	✓
	Kit de ruedas Kit wheels Kit de roulettes	✓	✓	✓	De serie Standard De serie	✓	✓	✓	✓	✓	✓	✓	✓

2

VITRINAS HOSTELERÍA

SERVE OVER COUNTERS CATERING

VITRINES HÔTELLERIE



VV-C Página 105
Vitrina expositora ventilada cristal curvo
Serve over counter curved glass
Vitrine serie vv gamme verre courbé



VV-MR Página 113
Vitrina expositora ventilada cristal panoramico
Serve over counter panoramic glass
Vitrine serie vv gamme verre panoramico



VV-R Página 107
Vitrina expositora ventilada cristal recto
Serve over counter straight glass
Vitrine serie vv gamme verre droite



VV-HE Página 115
Vitrina expositora ventilada caliente
Serve over counter hot
Vitrine serie vv gamme chaleur



VVA / VVAM Página 109
Vitrina expositora ventilada autoservicio
Serve over counter modular vva and vvam
Vitrine serie vva et vvam gamme modulaire



VCC-9 Página 117
Vitrina cerrada fondo 900
Vision display 9
Vitrine réfrigérée fermée 9



VV-RG Página 111
Vitrina expositora ventilada cristal panoramico
Serve over counter panoramic glass
Vitrine serie vv gamme verre panoramico



BS Página 119
Bandeja fría de tapas y sushi
Tapas and sushi cooler display
Plateaux froids tapas and sushi



VV-6-C: Cristal curvo, frontal cerrado
VV-6-C: Curved glass, closed front
VV-6-C: Verre bombé, façade fermée



VVA-6-C: Cristal curvo, frontal abierto
VVA-6-C: Curved glass, open front
VVA-6-C: Verre bombé, façade ouvrée



VVAM-6-C: Cristal curvo, frontal abierto, respaldo mural
VVAM-6-C: Curved glass, open front, wall backrest
VVAM-6-C: Verre bombé, façade ouvrée, paroi arrière



VV-6-R: Cristal recto, frontal cerrado (opcional puertas correderas)
VV-6-R: Straight glass, closed front (optional sliding doors)
VV-6-R: Verre droit, façade fermée (portes coulissantes en option)



VVA-6-R: Cristal recto, frontal abierto
VVA-6-R: Straight glass, self service front
VVA-6-R: Verre droit, façade libre-service



VVAM-6-R: Cristal recto, frontal abierto, respaldo mural
VVAM-6-R: Straight glass, self service front, wall backrest
VVAM-6-R: Verre droit, façade libre-service, paroi arrière



VVA-6-MR: Cristal inclinado recto, frontal abierto
VVA-6-MR: Inclined straight glass, open front
VVA-6-MR: verre droit incliné, façade libre-service



VVAM-6-MR: Cristal inclinado recto, frontal abierto, respaldo mural
VVAM-6-MR: Inclined straight glass, open front, wall backrest
VVAM-6-MR: verre droit incliné, façade libre-service, paroi arrière



VV-6-RGB: Cristal panorámico recto, 1 estante alt. 1.100mm
VV-6-RGB: Panoramic straight glass, 1 shelf ht. 1.100 mm
VV-6-RGB: Vitre panoramique droite, 1 étagère ht. 1.100 mm

VV-6-RGM: Cristal panorámico recto, 2 estantes alt. 1.195mm
VV-6-RGM: Panoramic straight glass, 2 shelves ht. 1.195 mm
VV-6-RGM: Vitre panoramique droite, 2 étagères ht. 1.195 mm

VV-6-RG: Cristal panorámico recto, 3 estantes alt. 1.380mm
VV-6-RG: Panoramic straight glass, 3 shelves ht. 1.380 mm
VV-6-RG: Vitre panoramique droite, 3 étagères ht. 1.380 mm

SERIE VV (Pag. 105-115)

MODELOS REFRIGERACIÓN (Pag. 105-115)

- Exterior fabricado en chapa de acero plastificada, lacada o inox
- Costados en ABS inyectado espesor 40 mm
- Interior en acero inoxidable AISI-304 18/10.
- Cristal doble lateral (todos los modelos) y frontal (modelos VV)
- Perfilera en aluminio anodizado
- Estantes de cristal regulables (en altura), con iluminación LED
- Aislamiento de poliuretano inyectado, densidad 40 Kg/m³, bajo GWP y cero efecto ODP
- Evaporador ventilado
- Descarga automática con evaporación automática
- Condensación ventilada
- Control electrónico de temperatura
- Clase climática 3 (25°C 60%HR)
- VV vitrina refrigerada para snack (+2°+8°)
- WB vitrina refrigerada para chocolates (+14°+17°, 55% HR)
- VV-RG/B vitrina refrigerada para snack (+2°+8°)
- VB-RG/B vitrina refrigerada para chocolates (+14°+17°, 55% HR)
- Chasis en acero acabado epoxy
- Modelos preinstalación incorporan valvulería solenoide y expansión termostática en R-449A, opción R-134a

MODELOS CALIENTES (Pag. 112-113)

- Cajón humidificador para aporte externo (solo VV)
- Control electrónico de temperatura
- Estantes de chapa de acero regulables
- **VV-HE vitrina cerrada caliente (+60°+70°) y (45% - 50%HR)**
- **VVAM-HE vitrina abierta caliente (+60°+70°) y (45% - 50%HR)**

VV SERIES (Pag. 105-115)

REFRIGERATED MODELS (Pag. 105-115)

- External finish in plastic coated steel, lacquered or stainless steel
- Sides in ABS injected thickness 40mm
- Internal finish in AISI-304 18/10 stainless steel
- Double side glass (all models) and front glass (VV models)
- Anodised aluminium profiles
- Adjustable glass shelves (height), with LED lighting
- 40 Kg/m³ density polyurethane insulation, low GWP and zero ODP effect
- Ventilated evaporator
- Auto defrost and automatic evaporation
- Ventilated condensation
- Electronic temperature controller
- Climate class 3 (25°C 60%HR)
- VV snacks refrigerated (+2°+8°)
- VB chocolate refrigerated (+14°+17°, 55% HR)
- VV-RG/B snacks refrigerated (+2°+8°)
- VB-RG/B chocolate refrigerated (+14°+17°, 55% HR)
- Chassis in epoxy finished steel
- Pre-installation models incorporate solenoid valve and thermostatic expansion in R-449A, option R-134a

HOT MODELS (Pag. 112-113)

- Humidifier drawer (Only VV)
- Electronic temperature controller
- Adjustable sheet steel shelves
- **VV-HE heat closed serve over counter (+60°+70°) and (45% - 50%HR)**
- **VVAM heat open serve over counter (+60°+70°) and (45% - 50%HR)**

SÉRIE VV (Pag. 105-115)

RÉFRIGÉRATION MODÈLES (Pag. 105-115)

- Extérieur fabriqué en tôle d'acier plastifiée, laquée ou inox
- Côtés en ABS injecté épaisseur 40mm
- Intérieur en acier inoxydable AISI 304 18/10
- Vitre double face (tous modèles) et vitre frontale (modèles VV)
- Profils en aluminium anodisé
- Étagères en verre réglable (en hauteur), avec éclairage LED.
- Isolation en polyuréthane injecté, densité de 40 Kg / m³, faible GWP et aucun effet ODP.
- Evaporateur ventilé
- Dégivrage automatique avec évaporation automatique
- Condensation ventilée
- Contrôle électronique de température
- Classe climatique 3 (25 ° C 60% HR)
- VV : vitrine réfrigérée pour snacks (+2°C à +8°C)
- VB : Vitrine réfrigérée pour chocolats (+14°C à +17°C, 55% HR)
- VV-RG/B : vitrine réfrigérée pour snacks (+2°C à +8°C)
- VB-RG/B : Vitrine réfrigérée pour chocolats (+14°C à +17°C, 55% HR)
- Châssis en acier fini époxy
- Les modèles de pré-installation incorporent l'électrovanne et l'expansion thermostatique R-449A en option R-134a

RÉFRIGÉRATION CHAUD (Pag. 112-113)

- Tiroir de l'humidificateur (VV modèles)
- Contrôle électronique de température
- Étagères en tôle d'acier réglables
- **VV-HE : vitrine fermé chaud (+60°C à +70°C) et (45% - 50%HR)**
- **VVAM-HE : vitrine ouvert chaud (+60°C à +70°C) et (45% - 50%HR)**

SERIE BS BANDEJAS FRIAS (Pag. 119-121)

- Exterior en acero inox AISI-304 18/10
- Fondo interior embutido en acero inox AISI 304 18/10
- Cristal templado y securizado
- Iluminación por LEDS
- Puertas transparentes correderas.
- Aislamiento de poliuretano inyectado, densidad 40 Kg/m³, bajo GWP y cero efecto ODP
- Patas reguladoras de altura
- Unidad condensadora ventilada, incluida en modelo remoto BS-1200 y BS-1500 (2 metros)
- Ajuste de temperatura y descarga por control electrónico digital
- Temperatura de trabajo BS +4° +8° a 32°C de ambiente
- Temperatura de trabajo BSMS, BSS, BSPM and BSPP 0° +5° a 32°C de ambiente
- BS Fondo plano, no GN 1/3
- BSMS BSPM Bandeja interior embutida, preparada para cubetas GN1/3-40 (incluidas)
- BSS BSPP Bandeja interior embutida, preparada para platos (no incluidos)
- BSM BSD Bandeja interior embutida, preparada para cubetas GN1/3-40 (incluidas)
- BSP BPD Bandeja interior embutida, preparada para platos

SERIES BS COOLER DISPLAY (Pag. 119-121)

- AISI-304 18/10 stainless steel exterior
- AISI-304 18/10 stainless steel stamped bottom
- Toughened safety glass
- LED lighting
- Transparent front sliding doors
- 40 Kg/m³ density polyurethane insulation, low GWP and zero ODP effect
- Adjustable supports
- Fan assisted condenser unit, included in remote models BS-1200 y BS-1500 (2 meters)
- Temperature and defrost sets by digital electronic control
- Operating temperature BS +4° +8°, 32°C ambient
- Operating temperature BSMS, BSS, BSPM and BSPP 0° +5°, 32°C ambient
- Working temperature 0° +5° a 32°C de ambient
- BS Not GN 1/3 capacity
- BSMS BSPM, stamped steel bottom, GN 1/3-40 containers capacity (included)
- BSS BSPP stamped steel (not GN capacity)
- BSM BSD, stamped steel bottom, GN 1/3-40 containers capacity (included)
- BSP BPD, stamped steel (not GN capacity)

SÉRIE BS PLATEUX FROIDS (Pag. 119-121)

- Extérieur en acier inoxydable AISI 304 18/10,
- Base encastrée en acier inox AISI 304 18/10
- Verre trempé et sécurisé
- Éclairage LED
- Portes transparentes coulissantes
- Isolation à base de polyuréthane injecté, densité 40 kg/m³, faible GWP et aucun effet ODP.
- Réglable en hauteur
- Condensateur ventilé, y compris dans le modèle à distance BS-1200 y BS-1500 (2mètres)
- Ajustement de température et dégivrage par contrôle électronique digital
- Température de travail BS +4°C à +8°C, à 32°C de température ambiante.
- Température de travail BSMS, BSS, BSPM and BSPP 0°C à +5°C, à 32°C de température ambiante. inclus
- BS Fond plat, non GN 1/3
- BSMS BSPM : Plateau intérieur encastré, préparé pour accueillir bacs / récipients (inclus).
- BSS BSPP : Plateau intérieur encastré, préparé pour accueillir des plats / assiettes (non inclus)
- BSM BSD Plateau intérieur embouti, préparé pour plateaux GN1/3-40 (inclus)
- BSP BPD Plateau intérieur embouti, préparé pour plaques (non inclus)

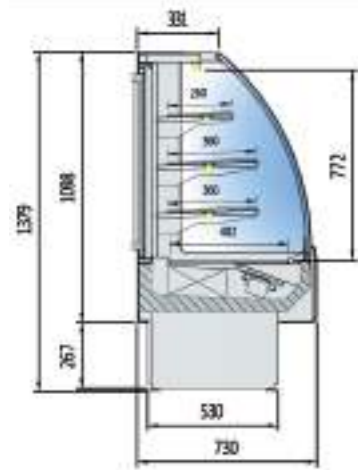

W-6-C



VV-6-13-C
vista trasera
rear view
vue arrière



Detalle apertura cristal y montaje estantes
Glass opening detail and mounting shelves
Détail d'ouverture en verre et étagères de montage

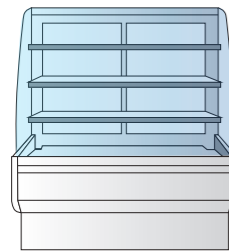

VV REFRIGERACIÓN
VV COOLING
VV REFROIDISSEMENT

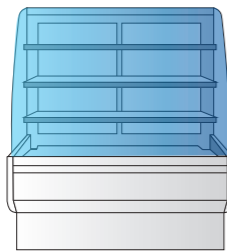

WB FRIO BOMBONES
WB CHOCOLATES
WB CHOCOLATS



VV-6-6-C
vista trasera
rear view
vue arrière



VV-6-6-C



VV-6-13-C

*Modelos en HFC, consultar precio / HFC Models, consult prices / Modèles HFC, consulter prix

Modelo Model Modèle	Largo Length Longueur (mm)	Área de estantes refrigerados Refrigerated shelf area Surface des plans refroidis (m ²)	Superficie total de exposición (TDA) Total display area (TDA) Surface totale de l'exposition (TDA) (m ²)	Volumen neto Net volume Volume utile (lts.)	Puertas correderas Sliding doors Portes coulissantes	Potencia frig. Cooling capacity Puissance frig. (W)	Consumo Consumption Consommation (W)	Refrigerante Coolant Réfrigérant
WV-6-6-C	600	0,74	0,55	140	1	483	837	R-290
WV-6-9-C	950	1,27	0,92	231	2	949	1140	R-290
WV-6-13-C	1300	1,78	1,29	322	2	949	1501	R-290
WV-6-16-C	1650	2,30	1,66	417	2	1528	1915	R-290
WB-6-6-C	600	0,74	0,55	140	1	483	837	R-290
WB-6-9-C	950	1,27	0,92	231	2	949	1140	R-290
WB-6-13-C	1300	1,78	1,29	322	2	949	1501	R-290
WB-6-16-C	1650	2,30	1,66	417	2	1528	1915	R-290

*Cambio de estantes de cristal a acero inox perforado: Sin incremento / *Change from glass shelves to perforated stainless steel: No increase / *Passage des clayettes verre à l'inox perforé : Pas d'augmentation

PVP de opcionales incluidos en equipo, no como repuesto / PVP of options included in the equipment, not as a spare part / PVP d'options incluses dans l'équipement, pas en tant que pièce de rechange

Modelo Model Modèle	Decoración interior negro Black interior decoration Décoration intérieure noire	Puerta cristal corredera Sliding glass door Porte coulissante en verre	kit ruedas Castors kit Jeu de roues	230v 60Hz / 115v 60 Hz
WV-6-6	156 €	-	240 €	Consultar - consult- Consulter
WV-6-9	274 €	193 €	240 €	Consultar - consult- Consulter
WV-6-13	354 €	267 €	240 €	Consultar - consult- Consulter
WV-6-16	411 €	305 €	360 €	Consultar - consult- Consulter

Características técnicas y constructivas sujetas a variación sin previo aviso. / We reserve the right to change specifications without prior notice. / Sujet technique et la conception de modifications sans préavis.



Clase Eficiencia Energética (Pag. 9)
Energy Efficiency Class (Pag. 9)

Laterales incluidos en PVP / Sides included in PVP / Latéraux inclus dans PVP

WV-6-6-C 3.214 €	WB-6-6-C 3.246 €	WV-6-13-C 4.330 €	WB-6-13-C 4.373 €
		WV-6-16-C 5.357 €	WB-6-16-C 5.410 €

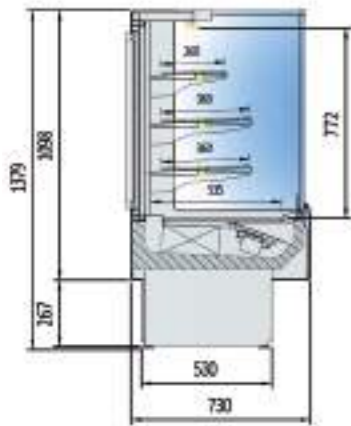
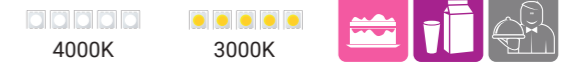

W-6-R



Detalle ruedas
Wheels detail
Roues de détail



Detalle apertura cristal y montaje estantes
Glass opening detail and mounting shelves
Détail d'ouverture en verre et étagères de montage



VV-6-9-R



VV-6-16-R



Clase Eficiencia Energética (Pag. 9)
Energy Efficiency Class (Pag. 9)

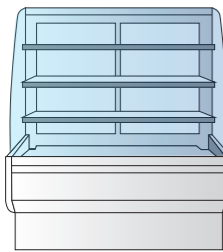

VV REFRIGERACIÓN
VV COOLING
VV REFROIDISSEMENT

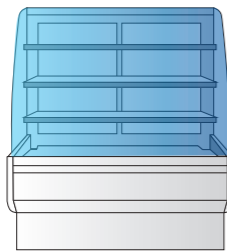

VVB FRIO BOMBONES
VVB CHOCOLATES
VVB CHOCOLATS



*Modelos en HFC, consultar precio / HFC Models, consult prices / Modèles HFC, consulter prix

Modelo Model Modèle	Largo Length Longueur (mm)	Área de estantes refrigerados Refrigerated shelf area Surface des plans refroidis (m ²)	Superficie total de exposición (TDA) Total display area (TDA) Surface totale de l'exposition (TDA) (m ²)	Volumen neto Net volume Volume utile (lts.)	Puertas correderas Sliding doors Portes coulissantes	Potencia frig. Cooling capacity Puissance frig. (W)	Consumo Consumption Consommation (W)	Refrigerante Coolant Réfrigérant
WV-6-6-R	600	0,74	0,55	140	1	483	837	R-290
WV-6-9-R	950	1,27	0,92	231	2	949	1140	R-290
WV-6-13-R	1300	1,78	1,29	322	2	949	1501	R-290
WV-6-16-R	1650	2,30	1,66	417	2	1528	1915	R-290
WBV-6-6-R	600	0,74	0,55	140	1	483	837	R-290
WBV-6-9-R	950	1,27	0,92	231	2	949	1140	R-290
WBV-6-13-R	1300	1,78	1,29	322	2	949	1501	R-290
WBV-6-16-R	1650	2,30	1,66	417	2	1528	1915	R-290

*Cambio de estantes de cristal a acero inox perforado: Sin incremento / *Change from glass shelves to perforated stainless steel: No increase / *Passage des clayettes verre à l'inox perforé : Pas d'augmentation

PVP de opcionales incluidos en equipo, no como repuesto / PVP of options included in the equipment, not as a spare part / PVP d'options incluses dans l'équipement, pas en tant que pièce de rechange

Modelo Model Modèle	Decoración interior negro Black interior decoration Décoration intérieure noire	Puerta cristal corredera Sliding glass door Porte coulissante en verre	kit ruedas Castors kit Jeu de roues	230v 60Hz / 115v 60 Hz
WV-6-6	156 €	-	240 €	Consultar - consult- Consulter
WV-6-9	274 €	193 €	240 €	Consultar - consult- Consulter
WV-6-13	354 €	267 €	240 €	Consultar - consult- Consulter
WV-6-16	411 €	305 €	360 €	Consultar - consult- Consulter

Características técnicas y constructivas sujetas a variación sin previo aviso. / We reserve the right to change specifications without prior notice. / Sujet technique et la conception de modifications sans préavis.



Laterales incluidos en PVP / Sides included in PVP / Latéraux inclus dans PVP

WV-6-6-R 3.417 €	WV-6-9-R 4.147 €	WV-6-13-R 4.584 €	WV-6-16-R 5.461 €
WBV-6-6-R 3.452 €	WBV-6-9-R 4.188 €	WBV-6-13-R 4.629 €	WBV-6-16-R 5.516 €

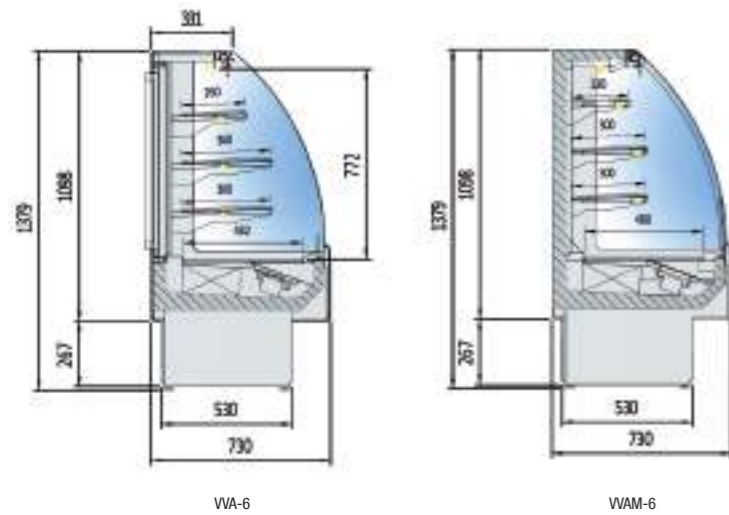

Detalle ruedas
Wheels detail
Roues de détail



Posibilidad de kit unión
Possibility of union kit
Possibilité de kit union

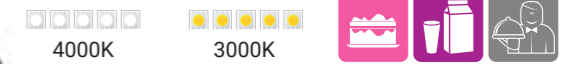

VVAM-6-16
Tipo mural - Wallback type - Type de mur



VVA-6-13-C

*Modelos en HFC, consultar precio / HFC Models, consult prices / Modèles HFC, consulter prix

Modelo Model Modèle	Largo Length Longueur (mm)	Área de estantes refrigerados Refrigerated shelf area Surface des plans refroidis (m²)	Superficie total de exposición (TDA) Total display area (TDA) Surface totale de l'exposition (TDA) (m²)	Volumen neto Net volume Volume utile (lts.)	Puertas correderas Sliding doors Portes coulissantes	Potencia frig. Cooling capacity Puissance frig. (W)	Consumo Consumption Consommation (W)	Refrigerante Coolant Réfrigérant
VVA-6-6	600	0,74	0,62	140	1	483	1137	R-290
VVA-6-9	950	1,27	1,03	231	2	949	1380	R-290
VVA-6-13	1300	1,78	1,44	322	2	1419	1670	R-290
VVA-6-16	1650	2,30	1,85	417	2	1931	2084	R-290
VVAM-6-6	600	0,66	0,62	128	0	483	1137	R-290
VVAM-6-9	950	1,13	1,03	209	0	949	1380	R-290
VVAM-6-13	1300	1,58	1,44	293	0	1419	1670	R-290
VVAM-6-16	1650	2,05	1,85	379	0	1931	2084	R-290

*Cambio de estantes de cristal a acero inox perforado: Sin incremento / *Change from glass shelves to perforated stainless steel: No increase / *Passage des clayettes verre à l'inox perforé : Pas d'augmentation

PVP de opcionales incluidos en equipo, no como repuesto / PVP of options included in the equipment, not as a spare part / PVP d'options incluses dans l'équipement, pas en tant que pièce de rechange

Modelo Model Modèle	Decoración interior negro VVA Black interior decoration VVA Décoration intérieure noire VVA	Decoración interior negro VVAM Black interior decoration VVAM Décoration intérieure noire VVAM	Puerta cristal corredera Sliding glass door Porte coulissante en verre	kit ruedas Castors kit Jeu de roues	230v 60Hz / 115v 60 Hz
VVA / VVAM-6-6	156 €	179 €	-	240 €	Consultar - consult- Consulter
VVA / VVAM-6-9	274 €	286 €	193 €	240 €	Consultar - consult- Consulter
VVA / VVAM-6-13	354 €	367 €	267 €	240 €	Consultar - consult- Consulter
VVA / VVAM-6-16	411 €	423 €	305 €	360 €	Consultar - consult- Consulter

Características técnicas y constructivas sujetas a variación sin previo aviso. / We reserve the right to change specifications without prior notice. / Sujet technique et la conception de modifications sans préavis.

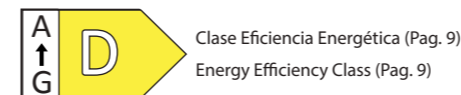

Clase Eficiencia Energética (Pag. 9)
Energy Efficiency Class (Pag. 9)

Laterales incluidos en PVP / Sides included in PVP / Latéraux inclus dans PVP

WA-6-6-C/R 3.457 €	WA-6-9-C/R 4.061 €	WA-6-13-C/R 4.501 €	WA-6-16-C/R 6.318 €
VVAM-6-6 3.069 €	VVAM-6-9 3.668 €	VVAM-6-13 4.000 €	VVAM-6-16 5.308 €

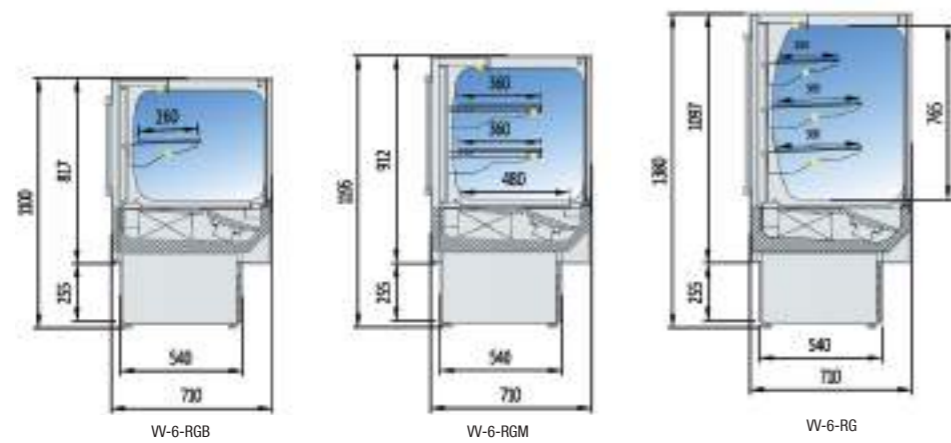

Detalle puertas correderas
Rear door detail
Détail des portes coulissantes



Detalle modelo VV-RGB encastrada
Detail model VV-RGB recessed
Modèle détaillé VV-RGB encastré



*Modelos en HFC, consultar precio / HFC Models, consult prices / Modèles HFC, consulter prix

Modelo Model Modèle	Largo Length Longueur (mm)	Área de estantes refrigerados Refrigerated shelf area Surface des plans refroidis (m ²)	Superficie total de exposición (TDA) Total display area (TDA) Surface totale de l'exposition (TDA) (m ²)	Volumen neto Net volume Volume utile (lts.)	Puertas correderas Sliding doors Portes coulissantes	Potencia frig. Cooling capacity Puissance frig. (W)	Consumo Consumption Consommation (W)	Refrigerante Coolant Réfrigérant
VV-6-6-RG	600	0,74	0,55	140	1	483	1137	R-290
VV-6-9-RG	950	1,27	0,92	231	2	949	1380	R-290
VV-6-13-RG	1300	1,78	1,29	322	2	1419	1670	R-290
VV-6-16-RG	1650	2,30	1,66	417	2	1931	2084	R-290
VV-6-6-RGM	600	0,60	0,50	120	1	483	1137	R-290
VV-6-9-RGM	950	1,03	0,86	197	2	949	1380	R-290
VV-6-13-RGM	1300	1,44	1,20	272	2	1419	1670	R-290
VV-6-16-RGM	1650	1,87	1,56	354	2	1931	2084	R-290
VV-6-6-RGB	600	0,37	0,46	85	1	483	1137	R-290
VV-6-9-RGB	950	0,63	0,79	135	2	949	1380	R-290
VV-6-13-RGB	1300	0,89	1,11	185	2	1419	1670	R-290
VV-6-16-RGB	1650	1,15	1,44	238	2	1931	2084	R-290

*Cambio de estantes de cristal a acero inox perforado: Sin incremento / *Change from glass shelves to perforated stainless steel: No increase / *Passage des clayettes verre à l'inox perforé : Pas d'augmentation

PVP de opcionales incluidos en equipo, no como repuesto / PVP of options included in the equipment, not as a spare part / PVP d'options incluses dans l'équipement, pas en tant que pièce de rechange

OPCIONES · OPTIONS · OPTIONS				
Modelo Model Modèle	Decoración interior negro Black interior decoration Décoration intérieure noire	Puerta cristal corredera Sliding glass door Porte coulissante en verre	kit ruedas Castors kit Jeu de roues	230v 60Hz / 115v 60 Hz
VV-6-6	156 €	-	240 €	Consultar - consult- Consulter
VV-6-9	274 €	193 €	240 €	Consultar - consult- Consulter
VV-6-13	354 €	267 €	240 €	Consultar - consult- Consulter
VV-6-16	411 €	305 €	360 €	Consultar - consult- Consulter

Características técnicas y constructivas sujetas a variación sin previo aviso. / We reserve the right to change specifications without prior notice. / Sujet technique et la conception de modifications sans préavis.

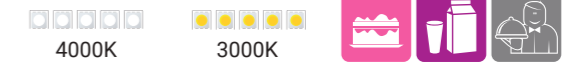

VV-6-9-RGB



VV-6-13-RGM



VV-6-9-RG

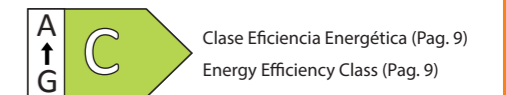

Laterales incluidos en PVP / Sides included in PVP / Latéraux inclus dans PVP

VV-6-6-RG 3.585 €	VV-6-9-RG 4.395 €	VV-6-13-RG 4.886 €	VV-6-16-RG 5.716 €
VV-6-6-RGM 3.518 €	VV-6-9-RGM 4.304 €	VV-6-13-RGM 4.844 €	VV-6-16-RGM 5.635 €
VV-6-6-RGB 3.463 €	VV-6-9-RGB 4.273 €	VV-6-13-RGB 4.769 €	VV-6-16-RGB 5.594 €



W / WA-6

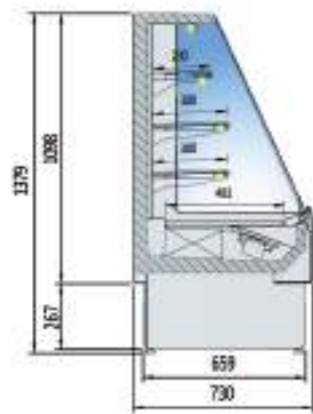

VVAM-6

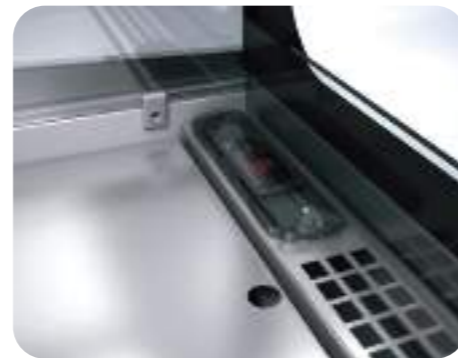

Detalle interior termostato
Interior detail thermostat
Intérieur détail thermostat



*Modelos en HFC, consultar precio / HFC Models, consult prices / Modèles HFC, consulter prix

Modelo Model Modèle	Largo Length Longueur (mm)	Área de estantes refrigerados Refrigerated shelf area Surface des plans refroidis (m²)	Superficie total de exposición (TDA) Total display area (TDA) Surface totale de l'exposition (TDA) (m²)	Volumen neto Net volume Volume utile (lts.)	Puertas correderas Sliding doors Portes coulissantes	Potencia frig. Cooling capacity Puissance frig. (W)	Consumo Consumption Consommation (W)	Refrigerante Coolant Réfrigérant
WV-6-6-MR	560	0,68	0,55	101	1	483	837	R-290
WV-6-9-MR	910	1,15	0,92	166	2	949	1140	R-290
VV-6-13-MR	1260	1,63	1,29	239	2	949	1501	R-290
VV-6-16-MR	1610	2,09	1,66	301	2	1528	1915	R-290
VA-6-6-MR	560	0,68	0,62	101	1	483	1137	R-290
VVA-6-9-MR	910	1,15	1,03	166	2	949	1380	R-290
VVA-6-13-MR	1260	1,63	1,44	239	2	1419	1670	R-290
VVA-6-16-MR	1610	2,09	1,85	301	2	1931	2084	R-290
VVAM-6-6-MR	560	0,62	0,62	93	0	483	1137	R-290
VVAM-6-9-MR	910	1,06	1,03	151	0	949	1380	R-290
VVAM-6-13-MR	1260	1,5	1,44	211	0	1419	1670	R-290
VVAM-6-16-MR	1610	1,94	1,85	273	0	1931	2084	R-290

*Cambio de estantes de cristal a acero inox perforado: Sin incremento / *Change from glass shelves to perforated stainless steel: No increase / *Passage des clayettes verre à l'inox perforé : Pas d'augmentation

PVP de opcionales incluidos en equipo, no como repuesto / PVP of options included in the equipment, not as a spare part / PVP d'options incluses dans l'équipement, pas en tant que pièce de rechange

Modelo Model Modèle	Decoración interior negro VVA-MR Black interior decoration VVA-MR Décoration intérieure noire VVA-MR	Decoración interior negro VVAM-MR Black interior decoration VVAM-MR Décoration intérieure noire VVAM-MR	kit ruedas Castors kit Jeu de roues	230v 60Hz / 115v 60 Hz
WV-6-6	156 €	179 €	240 €	Consultar - consult- Consulter
WV-6-9	274 €	286 €	240 €	Consultar - consult- Consulter
WV-6-13	354 €	367 €	240 €	Consultar - consult- Consulter
WV-6-16	411 €	423 €	360 €	Consultar - consult- Consulter

Características técnicas y constructivas sujetas a variación sin previo aviso. / We reserve the right to change specifications without prior notice. / Sujet technique et la conception de modifications sans préavis.



VVAM-6-9-MR

VV
A ↑ C → Clase Eficiencia Energética (Pag. 9)
Energy Efficiency Class (Pag. 9)

VVA / VVAM
A ↑ D → Clase Eficiencia Energética (Pag. 9)
Energy Efficiency Class (Pag. 9)

Laterales incluidos en PVP / Sides included in PVP / Latéraux inclus dans PVP

 WV-6-6-MR 3.417 €	 VV-6-9-MR 4.147 €	 VV-6-13-MR 4.584 €	 VV-6-16-MR 5.461 €
 VVA-6-6-MR 3.490 €	 VVA-6-9-MR 4.061 €	 VVA-6-13-MR 4.523 €	 VVA-6-16-MR 6.318 €
 VVAM-6-6-MR 3.373 €	 VVAM-6-9-MR 3.828 €	 VVAM-6-13-MR 4.305 €	 VVAM-6-16-MR 5.308 €

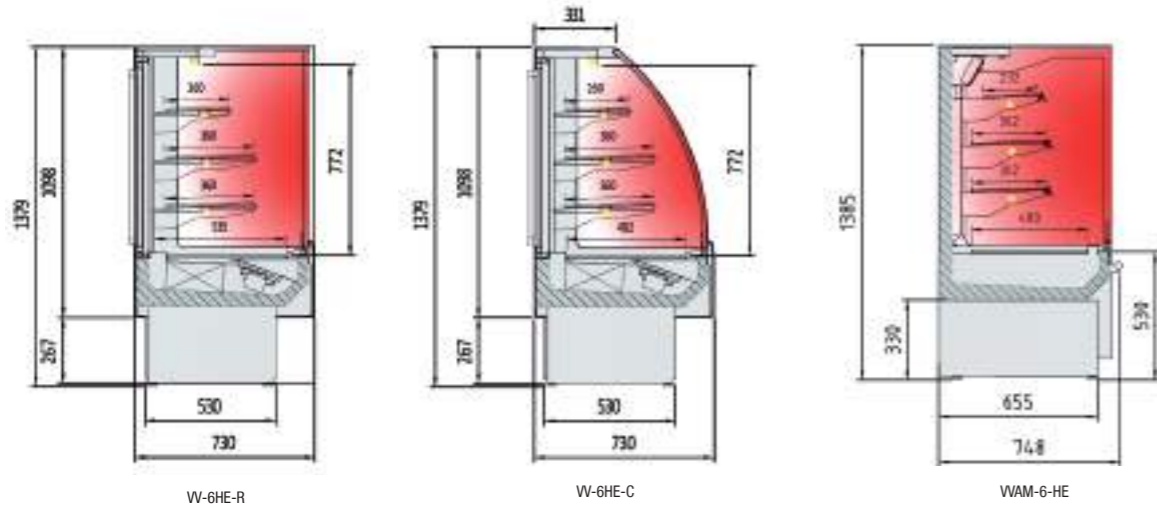

W-6HE-R

VV-6HE-C

WVAM-6-HE



Detalle cajon trasero humidificador (Disponible gama WV y VVA)
Detail rear humidifier drawer (VV and VVA range available)
Détail tiroir arrière humidificateur (Gamme WV et VVA disponible)

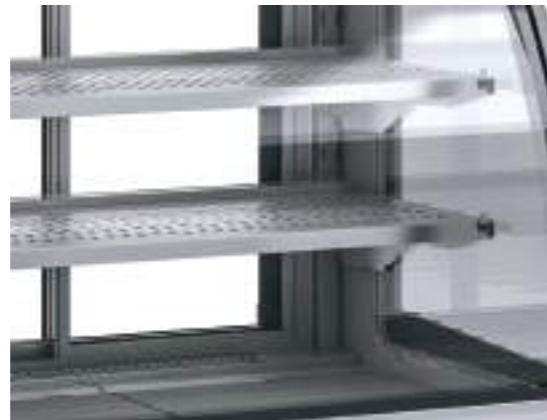

Detalle estantes de acero regulables
Detail stainless steel adjustable shelves
Détail d'étagères réglables en acier



VV-6HE-9-C
Total lacado
Total lacquered
Laqué total

4000K 3000K



WVAM-6-9-HE

Laterales incluidos en PVP / Sides included in PVP / Latéraux inclus dans PVP

Modelo Model Modèle	Largo Length Longueur (mm)	Área de estantes calefactado Refrigerated shelf area Surface des plans de chauffé (m²)	Superficie total de exposición (TDA) Total display area (TDA) Surface totale de l'exposition (TDA) (m²)	Volumen neto Net volume Volume utile (lts.)	Puertas correderas Sliding doors Portes coulissantes	Consumo Consumption Consommation (W)
WV-6HE-6	600	0,74	0,55	140	1	1049
WV-6HE-9	950	1,27	0,92	231	2	1683
WV-6HE-13	1300	1,78	1,29	322	2	2517
WV-6HE-16	1650	2,30	1,66	417	2	3351
WVAM-6HE-9	915	1,27	0,92	189	-	1683
WVAM-6HE-13	1265	1,78	1,29	280	-	2430

PVP de opcionales incluidos en equipo, no como repuesto / PVP of options included in the equipment, not as a spare part / PVP d'options incluses dans l'équipement, pas en tant que pièce de rechange

Modelo Model Modèle	Decoración interior negro WV Black interior decoration WV Décoration intérieure noire WV	Decoración interior negro WVAM Black interior decoration WVAM Décoration intérieure noire WVAM	kit ruedas Castors kit Jeu de roues	230v 60Hz / 115v 60 Hz
WV-6-6	156 €	-	240 €	Consultar - consult- Consulter
WV-6-9	274 €	286 €	240 €	Consultar - consult- Consulter
WV-6-13	354 €	367 €	240 €	Consultar - consult- Consulter
WV-6-16	411 €	-	360 €	Consultar - consult- Consulter

Características técnicas y constructivas sujetas a variación sin previo aviso. / We reserve the right to change specifications without prior notice. / Sujet technique et la conception de modifications sans préavis.

	WVAM-6HE-9 3.553 €		WVAM-6HE-13 4.024 €
	WV-6HE-6-R 2.930 €		WV-6HE-9-R 3.586 €
	WV-6HE-13-R 4.003 €		WV-6HE-16-R 4.795 €
	WV-6HE-6-C 2.858 €		WV-6HE-9-C 3.555 €
	WV-6HE-13-C 3.928 €		WV-6HE-16-C 4.748 €

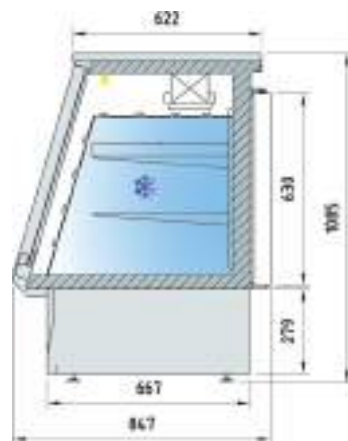

Detalle apertura frontal
Detail front opening
Détail ouverture frontale



VCC-9-20

CARACTERÍSTICAS TÉCNICAS

- Exterior en acero inox AISI-304 18/10
- Interior en acero inox AISI-304 18/10
- Puertas traseras con sistema de cierre automático y burlete magnético (permanece abierta al superar los 90° de apertura)
- Contrapuerta inox embutida
- Patas reguladoras de altura
- Iluminación interior LEDS
- Estantes interiores en acero plastificado
- Frontal abatible, cristal doble sobre marco de aluminio anodizado
- Evaporador estático con recubrimiento anticorrosión
- Unidad condensadora ventilada
- Evaporación automática del agua de descarche
- Aislamiento de poliuretano inyectado, densidad 40 Kg/m³, bajo GWP y cero efecto ODP
- Control digital de temperatura y descarches, eficiente en la gestión del consumo de energía
- Clase climática 4, (30°C 55%H.R.)
- Chasis en acero acabado epoxy

TECHNICAL DATA

- AISI-304 stainless steel exterior 18/10
- AISI-304 stainless steel interior 18/10
- Rear doors with self closing system, blocked opening hinge and magnetic gasket
- Rear-door by stamped steel
- Adjustable supports
- Interior lighting LEDS
- Shelves made of plasticized steel wire
- Double glazed front opening side, with anodized aluminium frame.
- Static evaporator, with anticorrosion coating.
- Veintilated condenser unit
- Automatic evaporation of defrost water
- 40 Kg/m³ density polyurethane insulation, low GWP and zero ODP effect
- Energy efficient digital controller of temperature and defrosts
- Climatic class 4, (30°C 55%H.R.)
- Chassis in epoxy finished steel

CARACTÉRISTIQUES TECHNIQUES

- Extérieur en inox AISI-304 18/10
- Intérieur en inox AISI.304 18/10
- Portes arrières avec système de fermeture automatique et bourrelet magnétique
- Contre-porte en acier estampé
- Hauteur réglable
- Éclairage intérieur LEDS
- Étagères intérieures en acier plastifié
- Façade rabattable, vitre double sur cadre d'aluminium anodisé
- Évaporateur statique avec recouvrement anticorrosion
- Groupe condensateur ventilé
- Évaporation automatique des eaux de dégivrage
- Isolation en polyuréthane injecté, densité 40 kg/m3, GWP faible et effet nul ODP
- Contrôle digital de température et de dégivrage, pour une gestion efficace de la consommation d'énergie
- Classe climatique 4, (30°C 55%H.R.)
- Châssis en acier fini époxy

*Modelos en HFC, consultar precio / HFC Models, consult prices / Modèles HFC, consulter prix

Modelo Model Modèle	Largo Length Longueur (mm.)	Área de estantes calefactado Refrigerated shelf area Surface des plans de chauffé (m²)	Superficie total de exposición (TDA) Total display area (TDA) Surface totale de l'exposition (TDA) (m²)	Potencia Frig. Frig Power Puissance Frig. (W)	Consumo Nominal Nominal Consumption Consommation Nominale (W)	Volumen neto Net volume Volume utile (Kg)	Puertas Doors Portes	Refrig. Coolant Réfrigérant
VCC-9-13	1315	1,83	0,37	781	417	289	2	R-290
VCC-9-15	1515	2,11	0,43	781	418	337	2	R-290
VCC-9-20	2015	2,84	0,59	949	485	456	3	R-290



Detalle vista trasera
Rear view detail
Détail de la vue arrière

PVP de opcionales incluidos en equipo, no como repuesto / PVP of options included in the equipment, not as a spare part / PVP d'options incluses dans l'équipement, pas en tant que pièce de rechange

OPCIONES · OPTIONS · OPTIONS

Cerradura puerta frontal	Front door lock	Serrure de porte d'entrée	61 € x set
Set 4 ruedas VCC-9-13/15	4 castors set VCC-9-13/15	Jeu 4 roulettes VCC-9-13/15	240 € x set
Set 6 ruedas VCC-9-20	6 castors set VCC-9-20	Jeu 6 roulettes VCC-9-20	360 € x set
Puerta trasera cristal	Rear door glass	Porte arrière vitrée	210 € und.

Características técnicas y constructivas sujetas a variación sin previo aviso. / We reserve the right to change specifications without prior notice. / Sujet technique et la conception de modifications sans préavis.

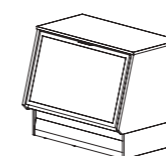

VCC-9-13 2.945 €

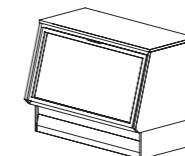

VCC-9-15 3.035 €

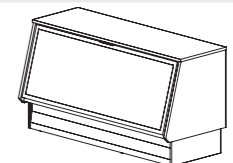

VCC-9-20 3.706 €

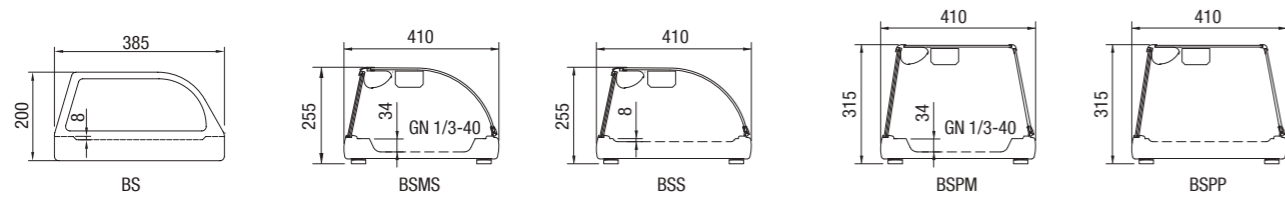

Detalle cristal y evaporador sushi
Detail glass evaporator sushi
Détail verre évaporateur sushi



BS-1400



BS-1500



BSS-1700

Modelo Model Modèle	Largo Length Longueur (mm.)	Alto Height Hauteur (mm.)	Fondo Depth Profondeur (mm.)	Potencia Frig. Frig Power Puissance Frig. (W)	Consumo Consumption Consommation (W)	GN 1/3-40	Peso Neto Net Weight Poid Net (Kg)	Tensión monofásica Single phase voltage Tension monophasique	Rango Range Gamme	Refrig. Coolant Réfrigérant
BSMS-4 / BSPM-4	1050	255 / 315	410	160	260	4	35	230 V - 50 Hz	0°C+5°C	R-290
BSMS-6 / BSPM-6	1400	255 / 315	410	190	280	6	42	230 V - 50 Hz	0°C+5°C	R-290
BSMS-8 / BSPM-8	1755	255 / 315	410	210	300	8	50	230 V - 50 Hz	0°C+5°C	R-290
BSS-1000 / BSPP-1000	1050	255 / 315	410	160	260	NO	34	230 V - 50 Hz	0°C+5°C	R-290
BSS-1400 / BSPP-1400	1400	255 / 315	410	190	280	NO	41	230 V - 50 Hz	0°C+5°C	R-290
BSS-1700 / BSPP-1700	1755	255 / 315	410	210	300	NO	49	230 V - 50 Hz	0°C+5°C	R-290
BS-1400	1400	200	385	160	220	NO	33	230 V - 50 Hz	+4°C+8°C	R-290
BS-1700	1750	200	385	160	240	NO	40	230 V - 50 Hz	+4°C+8°C	R-290
BS-1200	1200	200	385	160	220	NO	48	230 V - 50 Hz	+4°C+8°C	R-290
BS-1500	1550	200	385	160	240	NO	40	230 V - 50 Hz	+4°C+8°C	R-290



BSMS-4 **1.583 €**
BSS-1000 **1.500 €**

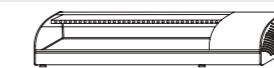

BSMS-6 **1.656 €**
BSS-1400 **1.629 €**

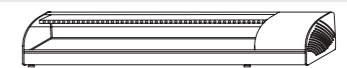

BSMS-8 **1.924 €**
BSS-1700 **1.770 €**

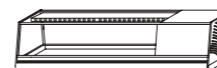

BSPM-4 **1.857 €**
BSPP-1000 **1.663 €**

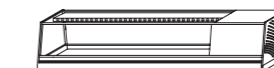

BSPM-6 **1.984 €**
BSPP-1400 **1.837 €**

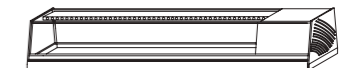

BSPM-8 **2.204 €**
BSPP-1700 **2.057 €**

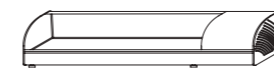

BS-1400 **1.300 €**

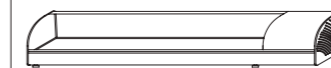

BS-1700 **1.440 €**

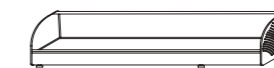

BS-1200 **1.248 €**

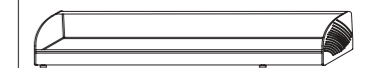

BS-1500 **1.386 €**

PVP de opcionales incluidos en equipo, no como repuesto / PVP of options included in the equipment, not as a spare part / PVP d'options incluses dans l'équipement, pas en tant que pièce de rechange

OPCIONES · OPTIONS · OPTIONS

Otros Refrigerantes Other refrigerants Autres réfrigérants	consultar - consult - consulter
230v 60Hz / 115v 60Hz.	consultar - consult - consulter

Características técnicas y constructivas sujetas a variación sin previo aviso. / We reserve the right to change specifications without prior notice. / Sujet technique et la conception de modifications sans préavis.

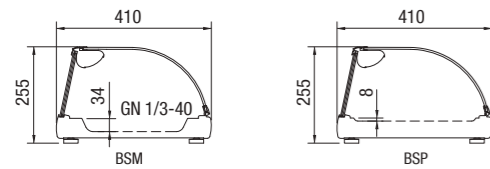

BSM-6



BSP-1400

Modelo Modèle	Largo Length Longueur (mm.)	Alto Height Hauteur mm.	Fondo Depth Profondeur mm.	Potencia Frig. Frig Power Puissance Frig. (W)	Consumo Consumption Consommation (W)	GN 1/3-40	Peso Neto Net Weight Poid Net (Kg)	Tensión monofásica Single phase voltage Tension monophasique	Rango Range Gamme	Refrig. Coolant Réfrigérant
BSM-4	1050	255	410	160	200	4	33	230 V - 50 Hz	+4°C+8°C	R-290
BSM-6	1400	255	410	160	220	6	40	230 V - 50 Hz	+4°C+8°C	R-290
BSM-8	1755	255	410	160	240	8	48	230 V - 50 Hz	+4°C+8°C	R-290
BSP-1000	1050	255	410	160	200		33	230 V - 50 Hz	+4°C+8°C	R-290
BSP-1400	1400	255	410	160	220		40	230 V - 50 Hz	+4°C+8°C	R-290
BSP-1700	1755	255	410	160	240		48	230 V - 50 Hz	+4°C+8°C	R-290
BPD-1400	1400	400	410	160	220		40	230 V - 50 Hz	+4°C+8°C	R-290
BPD-1700	1755	400	410	160	240		51	230 V - 50 Hz	+4°C+8°C	R-290

PVP de opcionales incluidos en equipo, no como repuesto / PVP of options included in the equipment, not as a spare part / PVP d'options incluses dans l'équipement, pas en tant que pièce de rechange

OPCIONES · OPTIONS · OPTIONS			
Otros Refrigerantes	Other refrigerants	Autres réfrigérants	consultar - consult - consulter
230v 60Hz / 115v 60Hz.	230v 60Hz / 115v 60Hz.	230v 60Hz / 115v 60Hz.	consultar - consult - consulter

Características técnicas y constructivas sujetas a variación sin previo aviso. / We reserve the right to change specifications without prior notice. / Sujet technique et la conception de modifications sans préavis.

BSM-4 1.260 €	BSM-6 1.415 €	BSM-8 1.554 €
BSP-1000 1.180 €	BSP-1400 1.280 €	BSP-1700 1.385 €

3 VITRINAS MURALES MULTIDECK DISPLAY MUREAUX



GAMA CEDAR Página 127
Modelo HE M1
HE M1 model
Modèle HE M1



GAMA CEDAR Página 137
H1 Sin puertas
H1 Whitout doors
H1 Aucune portes



GAMA CEDAR Página 129
Fondo 0 (653mm) M1-M2
Depth 0 (653mm) M1-M2
Profondeur 0 (653mm) M1-M2



GAMA CEDAR Página 139
Modelo Inox con puertas
Inox model with doors
Modèle Inox avec portes



GAMA CEDAR Página 131
Fondo 1 (797mm) M1-M2
Depth 1 (797mm) M1-M2
Profondeur 1 (797mm) M1-M2



GAMA CEDAR Página 141
Modelo Inox sin puertas
Inox model without doors
Modèle Inox sans portes



GAMA CEDAR Página 133
Fondo 3 (897mm) M1-M2
Depth 3 (897mm) M1-M2
Profondeur 3 (897mm) M1-M2



GAMA MAPLE Página 143
Mural Baja
Low Multideck
Murale Basse



GAMA CEDAR Página 135
H1 Con puertas
H1 Whit doors
H1 Avec portes

Para acabados exteriores en alto brillo, fluorescentes, luminiscentes, consultar precio
For exterior finishes in high gloss, fluorescent, luminescent, consult price
Pour finitions extérieures en brillant, fluorescent, luminescent, consulter le prix

FRANJA ESTÁNDAR
STANDARD STRIP · STANDARD BANDE









		
		
		
		
		
		
		
		

FRONTAL COMPLETO
FULL FRONTAL DECORATION · PLEIN DECORATION FRONTAL

INCREMENTO 1 · INCREASE 1 · AUGMENTER 1







	
	
	



DECORACIÓN TOTAL
TOTAL DECOR · DÉCORATION TOTAL

INCREMENTO 2 · INCREASE 2 · AUGMENTER 2



	
	
	



CARACTERÍSTICAS TÉCNICAS	TECHNICAL DATA	CARACTÉRISTIQUES TECHNIQUES
<ul style="list-style-type: none"> Mueble vertical grupo incorporado con capacidad y visibilidad optimizada del producto Modelo DS: Cortina de noche manual y frente cuba inferior de metacrilato Modelo DG: Puertas abatibles de vidrio con serigrafía mínima, apertura permitida hasta 93° y bloqueo de cierre manual. Autocierre con barra de torsión Gran posibilidad de personalización. Exterior (inferior y laterales) en gris RAL 7024, franja superior e inferior en chapa a elegir en los colores disponibles Estantes regulables en altura y ángulo, con portaprecios de 40 mm incluidos Evaporador ventilado con recubrimiento EPOXI anticorrosión Desescarche natural del evaporador Bandeja de evaporación automática Ventiladores electromecánicos, opcional electrónicos (consultar) Control electrónico Iluminación LED 24v 4000k en visera y montantes (solo en modelos DG) Temperatura de producto, según EN-ISO-23953: <ul style="list-style-type: none"> -M1: -1°+5°C, apropiado para carnes. -M2: -1°+7°C, apropiado para lácteos, delis y embutidos -H1: +1°+10°C, apropiado para frutas y verduras. Clase climática 3 (25°C, 60 H.R), excepto SVG1 (Clase climática 4) Modelos preinstalación incorporan valvulería solenoide y expansión termostática en R-449A, opción R-134a (consultar otros refrigerantes) Aislamiento de poliuretano inyectado, densidad 40kg/m3 bajo GWP y cero efecto ODP El paragolpes de tubo es opcional en todos los modelos (no incluido de serie) 	<ul style="list-style-type: none"> Plug in vertical cabinet with optimized capacity and visibility of the product DS Model: Manual night blind and inferior exposition deck perspex DG model: Glass folding doors with minimum screen printing, allowed opening up to 93° and manual closing lock. Self-closing with torsion bar High customization possibilities. As standard: plinth in colour RAL 7024, inferior and superior decorative stripe choose from available colours, except INOX model Adjustable shelves in height and angle, with 40 mm price holders included Ventilated evaporator EPOXY with anticorrosive coating Natural defrost of evaporator Automatic evaporation tray Electromechanic fans, électronique en option (consultar) Electronic control 24v LED lighting on vertical frame and superior 4000k colour(only models DG) Product temperature, according to EN-ISO-23953: <ul style="list-style-type: none"> -M1: -1°+5°C, suitable for meat -M2: -1°+7°C, suitable for dairy products, delis and sausages -H1: +1°+10°C, suitable for fruits and vegetables Climatic class 3 (25°C, 60 H.R), Except SVG1 (Climatic class 4) Pre-installation models incorporate solenoid and expansion valves thermostatic in R-449A, option R-134a (consult other refrigerants) Injected polyurethane insulation, density 40kg / m3 low GWP and zero ODP effect The tube bumper is optional on all models (not included as standard) 	<ul style="list-style-type: none"> Unité verticale intégrée avec capacité et visibilité optimisée du produit. Modèle DS: store de nuit manuel et façade inférieure du réservoir en méthacrylate Modèle DG: Portes pliantes en verre avec sérigraphie minimale, ouverture autorisée jusqu'à 93° et serrure à fermeture manuelle. Fermeture automatique avec barre de torsion Grande possibilité de personnalisation. Standard: plinthe inférieure en RAL 7024, bandes supérieure et inférieure en tôle au choix parmi les couleurs disponibles Tablettes réglables en hauteur et en angle, avec support de prix de 40 mm inclus Évaporateur ventilé EPOXY avec revêtement anticorrosion Dégivrage naturel de l'évaporateur Bac d'évaporation automatique Ventilateurs électromécaniques, électronique en option (consultar) Contrôle électronique Éclairage LED 24v 4000k sur la visière et les montants, (Modèles DG uniquement) Température du produit, selon EN-ISO-23953: <ul style="list-style-type: none"> -M1: -1° + 5°C, convient aux viandes. -M2: -1° + 7°C, convient aux produits laitiers, charcuteries et saucisses - -H1: + 1° + 10°C, convient aux fruits et légumes. Classe climatique 3 (25 ° C, 60 H.R), Except SVG1 (Classe climatique 4) Les modèles de pré-installation intègrent des électrovannes thermostatiques et des détendeurs dans le R-449A, option R-134a (consultar d'autres réfrigérants) Isolation polyuréthane injectée, densité 40kg / m3 faible GWP et zéro effet ODP Le pare-chocs tubulaire est en option sur tous les modèles (non inclus en standard)



DS3 15 M1-M2

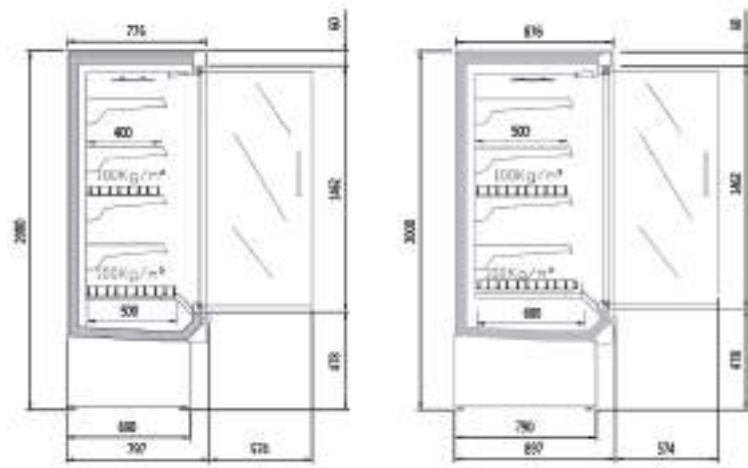

HDG1 M1 HE

HDG3 M1 HE

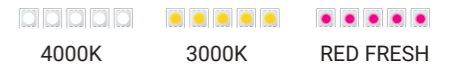

HDG1 12

Vertical led included in price
 Vertical led included in price
 Led verticale incluse dans le prix



Detalle puerta abierta
 Open door detail
 Détail de la porte ouverte

Ver características técnicas en página 125 / See technical data in page 125 / Voir caractéristiques techniques page 125

Modelo	Longitud (con costados)	Área estantes refrigerados	Superficie total exposicion	Volumen neto	Estantes	Puertas	Potencia frigorífica	Consumo nominal	Clase Energética	Refrigerante
Model	Length (with sides)	Refrigerated shelf area	Total display area	Net volume	Shelves	Doors	Cooling capacity	Nominal Power	Energy Class	Refrigerant
	(mm)	m2	(TDA)	(L)	Uds. Units	Uds. Units	(W)	(Kwh/24h)		
HDG1 09 M1	998	2,00	1,15	549	4	2	496 - 1018W	4,55	B	R-290
HDG1 12 M1	1310	2,68	1,50	714	4	2	497 - 1018W	5,4	B	R-290
HDG3 09 M1	998	2,47	1,17	659	4	2	498 - 1018W	4,55	B	R-290
HDG3 12 M1	1310	3,30	1,52	857	4	2	499 - 1018W	5,4	B	R-290

CARACTERÍSTICAS TÉCNICAS	TECHNICAL DATA	CARACTÉRISTIQUES TECHNIQUES
<ul style="list-style-type: none"> Lateral exterior panorámico incluido en PVP Exterior lacado o inox incluido en PVP Interior blanco 9003, negro 9005 incluido en PVP Compresor inverter de velocidad variable Ventiladores electrónicos Válvula de expansión electrónica Nivel sonoro modelo HDG 09: 36 db Nivel sonoro modelo HDG 12: 45 db 	<ul style="list-style-type: none"> Panoramic exterior side included in RRP Lacquered or stainless exterior included in PVP Interior white 9003, black 9005 included in PVP Variable speed inverter compressor Electronic fans Electronic expansion valve Sound level model HDG 09: 36 db Sound level model HDG 12: 45 db 	<ul style="list-style-type: none"> Côté extérieur panoramique inclus dans le PVC Extérieur laqué ou inoxydable inclus en PVP Intérieur blanc 9003, noir 9005 inclus dans PVP Compresseur inverseur à vitesse variable Ventilateurs électroniques Détendeur électronique Modèle de niveau sonore HDG 09: 36 db Modèle de niveau sonore HDG 12: 45 db

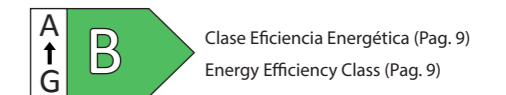

Clase Eficiencia Energética (Pag. 9)
 Energy Efficiency Class (Pag. 9)

Laterales incluidos en PVP / Sides included in PVP / Latéraux inclus dans PVP

HDG1 09 M1 5.692 €	HDG1 12 M1 5.745 €	HDG3 09 M1 5.789 €	HDG3 12 M1 5.842 €

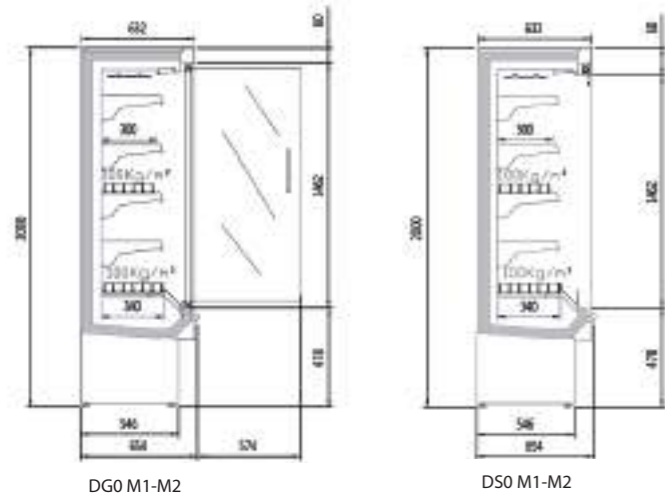

Decoración exterior total blanco, negro o gris RAL 7024 sin incremento de precio
 Total exterior decoration white, black or gray RAL 7024 without price increase
 Décoration extérieure totale blanc, noir ou gris RAL 7024 sans majoration de prix

CARACTERÍSTICAS TÉCNICAS

- Lateral estándar en ABS color gris RAL 7024,
- Opcional lateral cerrado sin incremento de precio (añadir al modelo -LC Ej: DG0 06 M1-M2-LC)
- 230v 60 Hz / 115v 60 Hz (consultar)

TECHNICAL DATA

- Standard side in ABS gray RAL 7024
- Optional side closed without price increase (add to model -LC Ej: DG0 06 M1-M2-LC)
- 230v 60 Hz / 115v 60 Hz (consult)

CARACTÉRISTIQUES TECHNIQUES

- Côté standard en ABS gris RAL 7024, fermé en option pas d'augmentation de prix
- Côté optionnel fermé sans augmentation de prix (ajouter au modèle -LC Ej: DG0 06 M1-M2-LC)
- 230v 60 Hz / 115v 60 Hz (consulter)

Ver características técnicas en página 125 / See technical data in page 125 / Voir caractéristiques techniques page 125

Modelo	Longitud (con costados)	Área estantes refrigerados	Superficie total exposición	Volumen neto	Estantes	Puertas	Potencia frigorífica HC	Consumo nominal HC	Refrigerante HC
Model	Length (with sides)	Refrigerated shelf area	Total display area	Net volume	Shelves	Doors	Cooling capacity HC	Nominal Power HC	Refrigerant HC
	(mm)	m2	(TDA)	(L)	Uds. Units	Uds. Units	(W)	(W)	(W)
MODELOS CON PUERTAS / MODELS WITH DOORS / MODÈLES AVEC PORTES									
DG0 06 M1-M2	685	1,00	0,73	255	4	1	555	1132	R-290
DG0 09 M1-M2	998	1,50	1,11	392	4	2	1192	1494	R-290
DG0 12 M1-M2	1310	2,00	1,46	510	4	2	1192	1508	R-290
DG0 15 M1-M2	1623	2,50	1,77	668	8	2	1419	1635	R-290
DG0 18 M1-M2	1935	3,00	2,19	784	8	3	1528	1945	R-290
DG0 25 M1-M2	2560	4,00	2,90	1020	8	4	2384	2612	R-290
DG0 31 M1-M2	3185	5,00	3,54	1336	16	4	2838	3377	R-290
MODELOS SIN PUERTAS / MODELS WITHOUT DOORS / MODÈLES SANS PORTES									
DS0 06 M1-M2	685	1,00	0,84	255	4	-	1192	1382	R-290
DS0 09 M1-M2	998	1,50	1,27	392	4	-	1528	1713	R-290
DS0 12 M1-M2	1310	2,00	1,64	510	4	-	1931	1885	R-290
DS0 15 M1-M2	1623	2,50	2,03	668	8	-	2384	2368	R-290
DS0 18 M1-M2	1935	3,00	2,50	784	8	-	3056	3026	R-290
DS0 25 M1-M2	2560	4,00	3,20	1020	8	-	3862	3770	R-290

*Modelos en HFC, consultar precio / HFC Models, consult prices / Modèles HFC, consulter prix
 PVP de opcionales incluidos en equipo, no como repuesto / PVP of options included in the equipment, not as a spare part / PVP d'options incluses dans l'équipement, pas en tant que pièce de rechange
 Interior epoxy negro sin incremento de precio / Black epoxy interior without price increase / Intérieur époxy noir sans majoration de prix

OPCIONES - OPTIONS - OPTIONS

Modelo	1 decoración frontal / front decor / décoration frontal	2 Total decoración / Total decor / décoration total	Tope estante metacrilato	Paragolpes tubo inox	Iluminación LED X nivel estantes	Estante de vidrio (ud.)	Pre Instalación
Model			Methacrylate shelf stopper	Stainless steel bumper	LED Lighting X shelves level	Glass shelf (pcs.)	Remote Unit
Modèle			Butée d'étagère en méthacrylate	Pare-chocs en acier inoxydable	Eclairage LED X niveau des étagères	Étagère en verre (pièces)	Groupe à distance
DG0 / DS0 06	248 €	441 €	30 €	41 €	39 €	215 €	-166 €
DG0 / DS0 09	258 €	449 €	35 €	59 €	58 €	215 €	-223 €
DG0 / DS0 12	272 €	456 €	38 €	75 €	75 €	215 €	-275 €
DG0 / DS0 15	282 €	462 €	40 €	88 €	80 €	215 €	-286 €
DG0 / DS0 18	302 €	469 €	56 €	108 €	112 €	215 €	-327 €
DG0 / DS0 25	312 €	475 €	66 €	137 €	151 €	215 €	-530 €
DG0 / 31	356 €	480 €	80 €	175 €	187 €	215 €	-733 €

Características técnicas y constructivas sujetas a variación sin previo aviso. / We reserve the right to change specifications without prior notice. / Sujet technique et la conception de modifications sans préavis.

VITRINA EXPOSITORA MURAL GAMA CEDAR FONDO 0 (653MM)

MULTIDECK DISPLAY CEDAR RANGE DEPTH 0 (653MM) - MUREAUX GAMME CEDAR PROFONDEUR 0 (653MM)



4000K 3000K RED FRESH



Lateral modelo cerrado LC
 Model closed side LC
 Côté fermé modèle LC

Vertical led included in price
 Vertical led included in price
 Led verticale incluse dans le prix

DG
 A ↑ G C
 Clase Eficiencia Energética (Pag. 9)
 Energy Efficiency Class (Pag. 9)

DS
 A ↑ G D
 Clase Eficiencia Energética (Pag. 9)
 Energy Efficiency Class (Pag. 9)

Mismo precio modelos M1 y M2 / Same price models M1 and M2 / Même prix modèles M1 et M2
 Laterales incluidos en PVP / Sides included in PVP / Latéraux inclus dans PVP

DG0 06 M	3.841 €	DG0 09 M	4.309 €	DG0 12 M	4.360 €	DG0 15 M	5.473 €	DG0 18 M	5.608 €	DG0 25 M	6.633 €	DG0 31 M	9.994 €
DS0 06 M	2.827 €	DS0 09 M	3.352 €	DS0 12 M	3.740 €	DS0 15 M	4.613 €	DS0 18 M	5.168 €	DS0 25 M	5.740 €		

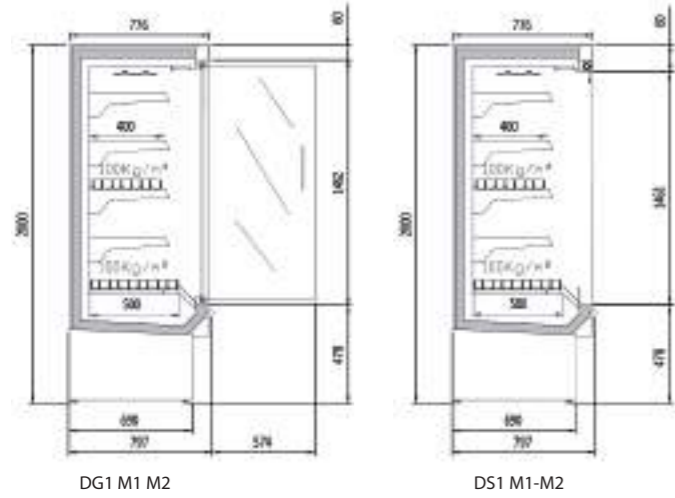

Decoración exterior total blanco, negro o gris RAL 7024 sin incremento de precio
 Total exterior decoration white, black or gray RAL 7024 without price increase
 Décoration extérieure totale blanc, noir ou gris RAL 7024 sans majoration de prix

CARACTERÍSTICAS TÉCNICAS

- Lateral estándar en ABS color gris RAL 7024,
- Opcional lateral cerrado sin incremento de precio (añadir al modelo -LC Ej: DGO 06 M1-M2-LC)
- Opcional lateral panorámico con incremento de precio (añadir al modelo -LE Ej: DGO 06 M1-M2-LE)
- 230v 60 Hz / 115v 60 Hz (consultar)

TECHNICAL DATA

- Standard side in ABS gray RAL 7024
- Optional side closed without price increase (add to model -LC Ej: DGO 06 M1-M2-LC)
- Optional panoramic side with price increase (add to the model -LE Ej: DGO 06 M1-M2-LE)
- 230v 60 Hz / 115v 60 Hz (consult)

CARACTÉRISTIQUES TECHNIQUES

- Côté standard en ABS gris RAL 7024, fermé en option pas d'augmentation de prix
- Côté optionnel fermé sans augmentation de prix (ajouter au modèle -LC Ej: DGO 06 M1-M2-LC)
- Côté panoramique en option avec augmentation de prix (ajouter au modèle -LE Ej: DGO 06 M1-M2-LE)
- 230v 60 Hz / 115v 60 Hz (consulter)

Ver características técnicas en página 125 / See technical data in page 125 / Voir caractéristiques techniques page 125

Modelo	Longitud (con costados)	Área estantes refrigerados	Superficie total exposición	Volumen neto	Estantes	Puertas	Potencia frigorífica HC	Consumo nominal HC	Refrigerante HC
Model	Length (with sides)	Refrigerated shelf area	Total display area	Net volume	Shelves	Doors	Cooling capacity HC	Nominal Power HC	Refrigerant HC
	(mm)	m2	(TDA)	(L)	Uds. Units	Uds. Units	(W)	(W)	(W)
MODELOS CON PUERTAS / MODELS WITH DOORS / MODÈLES AVEC PORTES									
DG1 06 M1-M2	685	1,34	0,76	357	4	1	555	1132	R-290
DG1 09 M1-M2	998	2,00	1,15	549	4	2	1192	1494	R-290
DG1 12 M1-M2	1310	2,68	1,50	714	4	2	1192	1508	R-290
DG1 15 M1-M2	1623	3,34	1,83	935	8	2	1419	1635	R-290
DG1 18 M1-M2	1935	4,01	2,24	1098	8	3	1528	1945	R-290
DG1 25 M1-M2	2560	5,35	2,94	1428	8	4	2384	2612	R-290
DG1 31 M1-M2	3185	6,69	3,60	1870	16	4	2838	3377	R-290
MODELOS SIN PUERTAS / MODELS WITHOUT DOORS / MODÈLES SANS PORTES									
DS1 06 M1-M2	685	1,34	0,87	357	4	-	1192	1382	R-290
DS1 09 M1-M2	998	2,00	1,32	549	4	-	1528	1713	R-290
DS1 12 M1-M2	1310	2,68	1,72	714	4	-	1931	1885	R-290
DS1 15 M1-M2	1623	3,34	2,10	935	8	-	2384	2368	R-290
DS1 18 M1-M2	1935	4,01	2,58	1098	8	-	3056	3026	R-290
DS1 25 M1-M2	2560	5,35	3,38	1428	8	-	3862	3770	R-290

*Modelos en HFC, consultar precio / HFC Models, consult prices / Modèles HFC, consulter prix
 PVP de opcionales incluidos en equipo, no como repuesto / PVP of options included in the equipment, not as a spare part / PVP d'options incluses dans l'équipement, pas en tant que pièce de rechange
 Interior epoxy negro sin incremento de precio / Black epoxy interior without price increase / Intérieur époxy noir sans majoration de prix

OPCIONES - OPTIONS - OPTIONS

Modelo	1 decoración frontal / front decor / décoration frontal	2 Total decoración / Total decor / décoration total	Tope estante metacrilato	Paragolpes tubo inox	Iluminación LED X nivel estantes	Estante de vidrio (ud.)	Pre Instalación
Model			Methacrylate shelf stopper	Stainless steel bumper	LED Lighting X shelves level	Glass shelf (pcs.)	Remote Unit
Modèle			Butée d'étagère en méthacrylate	Pare-chocs en acier inoxydable	Eclairage LED X niveau des étagères	Étagère en verre (pièces)	Groupe à distance
DG1 / DS1 06	248 €	441 €	30 €	41 €	39 €	215 €	-166 €
DG1 / DS1 09	258 €	449 €	35 €	59 €	58 €	215 €	-223 €
DG1 / DS1 12	272 €	456 €	38 €	75 €	75 €	215 €	-275 €
DG1 / DS1 15	282 €	462 €	40 €	88 €	80 €	215 €	-286 €
DG1 / DS1 18	302 €	469 €	56 €	108 €	112 €	215 €	-327 €
DG1 / DS1 25	312 €	475 €	66 €	137 €	151 €	215 €	-530 €
DG1 / 31	356 €	480 €	80 €	175 €	187 €	215 €	-733 €

Características técnicas y constructivas sujetas a variación sin previo aviso. / We reserve the right to change specifications without prior notice. / Sujet technique et la conception de modifications sans préavis.

VITRINA EXPOSITORA MURAL GAMA CEDAR FONDO 1 (797MM)
MULTIDECK DISPLAY CEDAR RANGE DEPTH 1 (797MM) - MUREAUX GAMME CEDAR PROFONDEUR 1 (797MM)



4000K 3000K RED FRESH



DG1 18 M1-M2

Vertical led included in price
 Vertical led included in price
 Led verticale incluse dans le prix

Lateral modelo plástico (De serie)
 Model plastic side (As standard)
 Côté plastique modelé (En série)

Lateral modelo cerrado
 Model closed side
 Côté fermé modelé



Lateral modelo panorámico LE
 Model panoramic side LE
 Côté panoramique modelé LE

LE 933 €

DG



Clase Eficiencia Energética (Pag. 9)
 Energy Efficiency Class (Pag. 9)

DS



Clase Eficiencia Energética (Pag. 9)
 Energy Efficiency Class (Pag. 9)

Mismo precio modelos M1 y M2 / Same price models M1 and M2 / Même prix modèles M1 et M2

Laterales incluidos en PVP / Sides included in PVP / Latéraux inclus dans PVP

DG1 06 M	3.960 €	DG1 09 M	4.394 €	DG1 12 M	4.447 €	DG1 15 M	5.558 €	DG1 18 M	5.715 €	DG1 25 M	6.860 €	DG1 31 M	10.236 €
DS1 06 M	2.954 €	DS1 09 M	3.485 €	DS1 12 M	3.879 €	DS1 15 M	4.926 €	DS1 18 M	5.272 €	DS1 25 M	5.826 €		

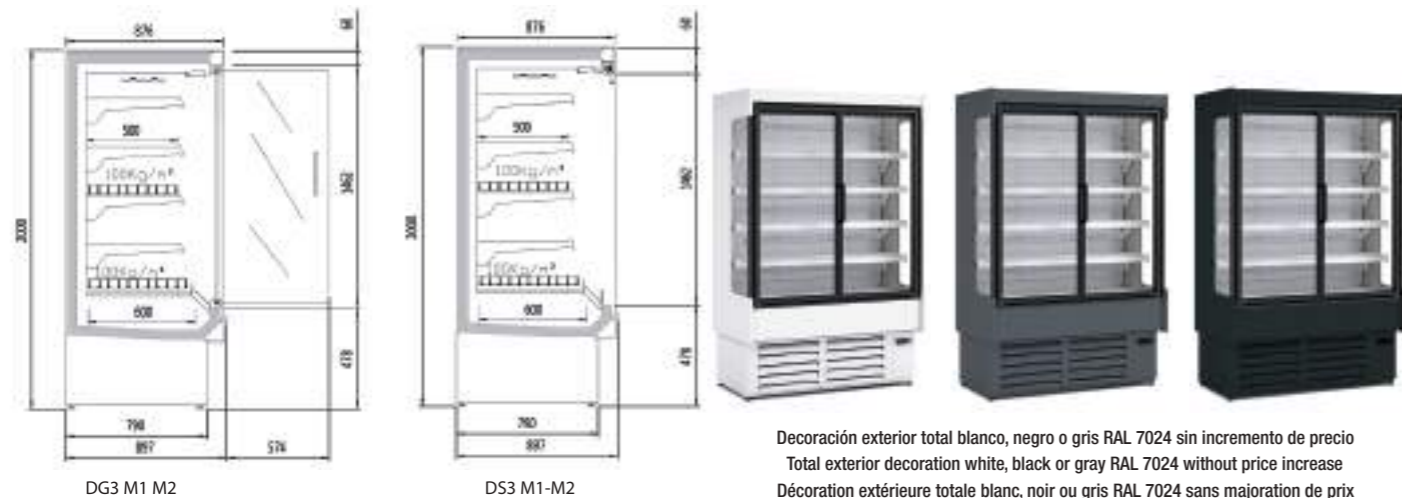

Decoración exterior total blanco, negro o gris RAL 7024 sin incremento de precio
Total exterior decoration white, black or gray RAL 7024 without price increase
Décoration extérieure totale blanc, noir ou gris RAL 7024 sans majoration de prix



CARACTERÍSTICAS TÉCNICAS

- Lateral estándar en ABS color gris RAL 7024,
- Opcional lateral cerrado sin incremento de precio (añadir al modelo -LC Ej: DGO 06 M1-M2-LC)
- Opcional lateral panorámico con incremento de precio (añadir al modelo -LE Ej: DGO 06 M1-M2-LE)
- 230v 60 Hz / 115v 60 Hz (consultar)

TECHNICAL DATA

- Standard side in ABS gray RAL 7024
- Optional side closed without price increase (add to model -LC Ej: DGO 06 M1-M2-LC)
- Optional panoramic side with price increase (add to the model -LE Ej: DGO 06 M1-M2-LE)
- 230v 60 Hz / 115v 60 Hz (consult)

CARACTÉRISTIQUES TECHNIQUES

- Côté standard en ABS gris RAL 7024, fermé en option pas d'augmentation de prix
- Côté optionnel fermé sans augmentation de prix (ajouter au modèle -LC Ej: DGO 06 M1-M2-LC)
- Côté panoramique en option avec augmentation de prix (ajouter au modèle -LE Ej: DGO 06 M1-M2-LE)
- 230v 60 Hz / 115v 60 Hz (consulter)

Ver características técnicas en página 125 / See technical data in page 125 / Voir caractéristiques techniques page 125

Modelo	Longitud (con costados)	Área estantes refrigerados	Superficie total exposición	Volumen neto	Estantes	Puertas	Potencia frigorífica HC	Consumo nominal HC	Refrigerante HC
Model	Length (with sides)	Refrigerated shelf area	Total display area	Net volume	Shelves	Doors	Cooling capacity HC	Nominal Power HC	Refrigerant HC
	(mm)	m2	(TDA)	(L)	Uds. Units	Uds. Units	(W)	(W)	
MODELOS CON PUERTAS / MODELS WITH DOORS / MODÈLES AVEC PORTES									
DG3 06 M1-M2	685	1,65	0,78	428	4	1	555	1132	R-290
DG3 09 M1-M2	998	2,47	1,17	659	4	2	1192	1494	R-290
DG3 12 M1-M2	1310	3,30	1,52	857	4	2	1192	1508	R-290
DG3 15 M1-M2	1623	4,12	1,88	1122	8	2	1419	1635	R-290
DG3 18 M1-M2	1935	4,95	2,29	1317	8	3	1528	1945	R-290
DG3 25 M1-M2	2560	6,60	2,99	1714	8	4	2384	2612	R-290
DG3 31 M1-M2	3185	8,25	3,71	2244	16	4	2838	3377	R-290
MODELOS SIN PUERTAS / MODELS WITHOUT DOORS / MODÈLES SANS PORTES									
DS3 06 M1-M2	685	1,65	0,90	428	4	-	1192	1382	R-290
DS3 09 M1-M2	998	2,47	1,34	659	4	-	1528	1713	R-290
DS3 12 M1-M2	1310	3,30	1,75	857	4	-	1931	1885	R-290
DS3 15 M1-M2	1623	4,12	2,16	1122	8	-	2384	2368	R-290
DS3 18 M1-M2	1935	4,95	2,63	1317	8	-	3056	3026	R-290
DS3 25 M1-M2	2560	6,60	3,44	1714	8	-	3862	3770	R-290

*Modelos en HFC, consultar precio / HFC Models, consult prices / Modèles HFC, consulter prix
PVP de opcionales incluidos en equipo, no como repuesto / PVP of options included in the equipment, not as a spare part / PVP d'options incluses dans l'équipement, pas en tant que pièce de rechange
Interior epoxy negro sin incremento de precio / Black epoxy interior without price increase / Intérieur époxy noir sans majoration de prix

OPCIONES - OPTIONS - OPTIONS

Modelo	1 decoración frontal / front decor / décoration frontal	2 Total decoración / Total decor / décoration total	Tope estante metacrilato	Paragolpes tubo inox	Iluminación LED X nivel estantes	Estante de vidrio (ud.)	Pre Instalación
Model			Methacrylate shelf stopper	Stainless steel bumper	LED Lighting X shelves level	Glass shelf (pcs.)	Remote Unit
Modèle			Butée d'étagère en méthacrylate	Pare-chocs en acier inoxydable	Eclairage LED X niveau des étagères	Étagère en verre (pièces)	Groupe à distance
DG3 / DS3 06	248 €	441 €	30 €	41 €	39 €	215 €	-166 €
DG3 / DS3 09	258 €	449 €	35 €	59 €	58 €	215 €	-223 €
DG3 / DS3 12	272 €	456 €	38 €	75 €	75 €	215 €	-275 €
DG3 / DS3 15	282 €	462 €	40 €	88 €	80 €	215 €	-286 €
DG3 / DS3 18	302 €	469 €	56 €	108 €	112 €	215 €	-327 €
DG3 / DS3 25	312 €	475 €	66 €	137 €	151 €	215 €	-530 €
DG3 / 31	356 €	480 €	80 €	175 €	187 €	215 €	-733 €

Características técnicas y constructivas sujetas a variación sin previo aviso. / We reserve the right to change specifications without prior notice. / Sujet technique et la conception de modifications sans préavis.



Lateral modelo plástico (De serie) / Model plastic side (As standard) / Côté plastique modelé (En série)
Lateral modelo cerrado / Model cosed side / Côté fermé modelé
Lateral modelo panorámico LE / Model panoramic side LE / Côté panoramique modelé LE

Mismo precio modelos M1 y M2 / Same price models M1 and M2 / Même prix modèles M1 et M2

Laterales incluidos en PVP / Sides included in PVP / Latéraux inclus dans PVP

DG3 06 M1	4.158 €	DG3 09 M1	4.491 €	DG3 12 M1	4.544 €	DG3 15 M1	5.653 €	DG3 18 M1	5.844 €	DG3 25 M1	6.914 €	DG3 31 M1	11.035 €
DS3 06 M1	3.030 €	DS3 09 M1	3.529 €	DS3 12 M1	3.928 €	DS3 15 M1	5.191 €	DS3 18 M1	5.398 €	DS3 25 M1	5.900 €		

LED vertical incluido en precio
Vertical led included in price
Led verticale incluse dans le prix

DG
A ↑ C → Clase Eficiencia Energética (Pag. 9)
Energy Efficiency Class (Pag. 9)

DS
A ↑ D → Clase Eficiencia Energética (Pag. 9)
Energy Efficiency Class (Pag. 9)

LE 933 €

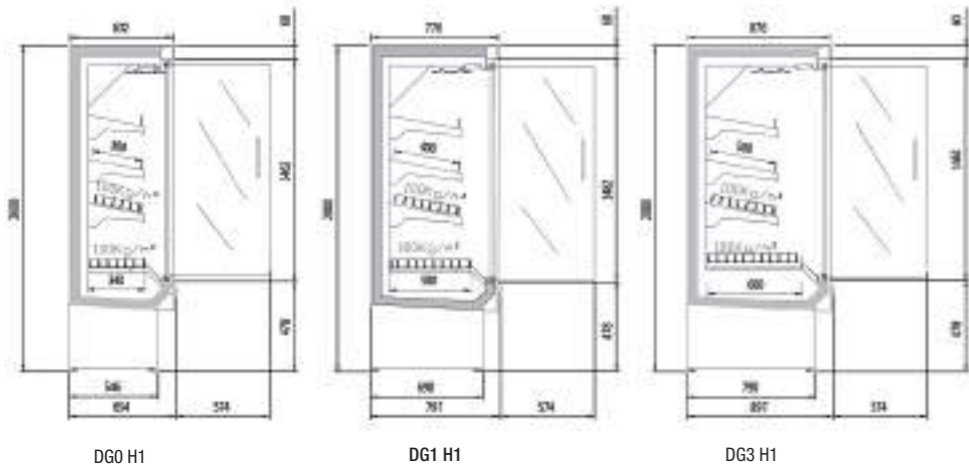

Decoración exterior total blanco, negro o gris RAL 7024 sin incremento de precio
 Total exterior decoration white, black or gray RAL 7024 without price increase
 Décoration extérieure totale blanc, noir ou gris RAL 7024 sans majoration de prix

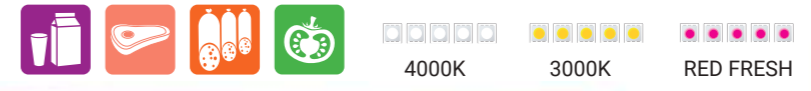

Lateral modelo plástico (De serie)
 Model plastic side (As standard)
 Côté plastique modelé (En série)

Led vertical incluido en precio
 Vertical led included in price
 Led verticale incluse dans le prix



Lateral modelo cerrado LC
 Model closed side LC
 Côté fermé modelé LC

CARACTERÍSTICAS TÉCNICAS	TECHNICAL DATA	CARACTÉRISTIQUES TECHNIQUES
<ul style="list-style-type: none"> Lateral estándar en ABS color gris RAL 7024. Opcional lateral cerrado sin incremento de precio (añadir al modelo -LC Ej: DG0 06 M1-M2-LC) Opcional lateral panorámico con incremento de precio (añadir al modelo -LE Ej: DG0 06 M1-M2-LE) 230v 60 Hz / 115v 60 Hz (consultar) Espejo superior de serie Tope metacrilato frontal de serie Temperatura H1 	<ul style="list-style-type: none"> Standard side in ABS gray RAL 7024 Optional side closed without price increase (add to model -LC Ej: DG0 06 M1-M2-LC) Optional panoramic side with price increase (add to the model -LE Ej: DG0 06 M1-M2-LE) 230v 60 Hz / 115v 60 Hz (consult) Standard top mirror Standard front methacrylate stop H1 Temperature 	<ul style="list-style-type: none"> Côté standard en ABS gris RAL 7024, fermé en option pas d'augmentation de prix Côté optionnel fermé sans augmentation de prix (ajouter au modèle -LC Ej: DG0 06 M1-M2-LC) Côté panoramique en option avec augmentation de prix (ajouter au modèle -LE Ej: DG0 06 M1-M2-LE) 230v 60 Hz / 115v 60 Hz (consultar) Miroir supérieur standard Butée avant en méthacrylate standard Température H1

Ver características técnicas en página 125 / See technical data in page 125 / Voir caractéristiques techniques page 125

Modelo	Longitud (con costados)	Área estantes refrigerados m2			Superficie total exposición (TDA)			Volumen neto (L)			Estantes	Puertas	Potencia frigorífica HC	Consumo nominal HC	Refrigerante HC		
Model	Length (with sides)	Refrigerated shelf area m2			Total display area (TDA)			Net volume (L)			Shelves	Doors	Cooling capacity HC	Nominal Power HC	Refrigerant HC		
	(mm)	Fondo/Depth 0	Fondo/Depth 1	Fondo/Depth 3	Fondo/Depth 0	Fondo/Depth 1	Fondo/Depth 3	Fondo/Depth 0	Fondo/Depth 1	Fondo/Depth 3	Uds.	Units	Uds.	Units	(W)	(W)	
DG 06 H1	685	0,81	1,08	1,33	0,72	0,75	0,77	239	336	403	3	1	555	1132	R-290		
DG 09 H1	998	1,21	1,62	2,00	1,09	1,13	1,15	368	516	619	3	2	1192	1494	R-290		
DG 12 H1	1310	1,61	2,16	2,66	1,44	1,48	1,50	480	671	805	3	2	1192	1508	R-290		
DG 15 H1	1623	2,02	2,70	3,33	1,75	1,81	1,86	628	879	1055	6	2	1419	1635	R-290		
DG 18 H1	1935	2,42	3,24	4,00	2,17	2,22	2,27	737	1032	1238	6	3	1528	1945	R-290		
DG 25 H1	2560	3,23	4,33	5,33	2,88	2,92	2,97	959	1342	1611	6	4	2384	2612	R-290		
DG 31 H1	3185	4,03	5,41	6,65	3,52	3,58	3,69	1256	1758	2110	12	4	2838	3377	R-290		

*Modelos en HFC, consultar precio / HFC Models, consult prices / Modèles HFC, consulter prix
 PVP de opcionales incluidos en equipo, no como repuesto / PVP of options included in the equipment, not as a spare part / PVP d'options incluses dans l'équipement, pas en tant que pièce de rechange
 Interior epoxy negro sin incremento de precio / Black epoxy interior without price increase / Intérieur époxy noir sans majoration de prix

Modelo	OPCIONES - OPTIONS - OPTIONS		Paragolpes tubo inox	Iluminación LED	Pre Instalación
Model	1 decoración frontal / front decor / décoration frontal	2 Total decoración / Total decor / décoration total	Stainless steel bumper	X nivel estantes / LED Lighting X shelves level / Eclairage LED X niveau des étagères	Remote Unit / Groupe à distance
Modèle			Pare-chocs en acier inoxydable		
DG 06 H1	248 €	441 €	41 €	39 €	-166 €
DG 09 H1	258 €	449 €	59 €	58 €	-223 €
DG 12 H1	272 €	456 €	75 €	75 €	-275 €
DG 15 H1	282 €	462 €	88 €	80 €	-286 €
DG 18 H1	302 €	469 €	108 €	112 €	-327 €
DG 25 H1	312 €	475 €	137 €	151 €	-530 €
DG 31 H1	356 €	480 €	175 €	187 €	-733 €

Características técnicas y constructivas sujetas a variación sin previo aviso. / We reserve the right to change specifications without prior notice. / Sujet technique et la conception de modifications sans préavis.

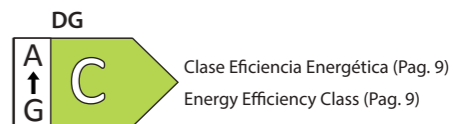

Clase Eficiencia Energética (Pag. 9)
 Energy Efficiency Class (Pag. 9)

Laterales incluidos en PVP / Sides included in PVP / Latéraux inclus dans PVP

DG0 06 H1	3.801 €	DG0 09 H1	4.393 €	DG0 12 H1	4.445 €	DG0 15 H1	5.557 €	DG0 18 H1	5.717 €	DG0 25 H1	6.762 €	DG0 31 H1	9.880 €
DG1 06 H1	3.953 €	DG1 09 H1	4.436 €	DG1 12 H1	4.490 €	DG1 15 H1	5.567 €	DG1 18 H1	5.769 €	DG1 25 H1	6.824 €	DG1 31 H1	10.220 €
DG3 06 H1	4.154 €	DG3 09 H1	4.542 €	DG3 12 H1	4.597 €	DG3 15 H1	5.571 €	DG3 18 H1	5.912 €	DG3 25 H1	6.994 €	DG3 31 H1	10.649 €

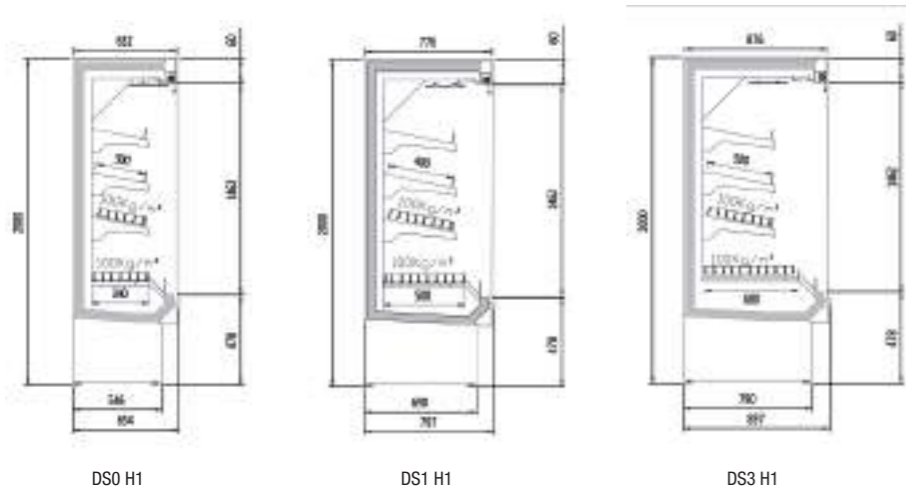

Decoración exterior total blanco, negro o gris RAL 7024 sin incremento de precio
 Total exterior decoration white, black or gray RAL 7024 without price increase
 Décoration extérieure totale blanc, noir ou gris RAL 7024 sans majoration de prix



4000K 3000K RED FRESH



Lateral modelo cerrado LC
 Model closed side LC
 Côté fermé modèle LC



Lateral modelo panorámico LE
 Model panoramic side LE
 Côté panoramique modèle LE

LE **933 €**

DS3 18 H1

DS



Clase Eficiencia Energética (Pag. 9)
 Energy Efficiency Class (Pag. 9)

Laterales incluidos en PVP / Sides included in PVP / Latéraux inclus dans PVP

CARACTERÍSTICAS TÉCNICAS	TECHNICAL DATA	CARACTÉRISTIQUES TECHNIQUES
<ul style="list-style-type: none"> Lateral estándar en ABS color gris RAL 7024. Opcional lateral cerrado sin incremento de precio (añadir al modelo -LC Ej: DGO 06 M1-M2-LC) Opcional lateral panorámico con incremento de precio (añadir al modelo -LE Ej: DGO 06 M1-M2-LE) 230v 60 Hz / 115v 60 Hz (consultar) Espejo superior de serie Tope metacrilato frontal de serie Temperatura H1 	<ul style="list-style-type: none"> Standard side in ABS gray RAL 7024 Optional side closed without price increase (add to model -LC Ej: DGO 06 M1-M2-LC) Optional panoramic side with price increase (add to the model -LE Ej: DGO 06 M1-M2-LE) 230v 60 Hz / 115v 60 Hz (consult) Standard top mirror Standard front methacrylate stop H1 Temperature 	<ul style="list-style-type: none"> Côté standard en ABS gris RAL 7024, fermé en option pas d'augmentation de prix Côté optionnel fermé sans augmentation de prix (ajouter au modèle -LC Ej: DGO 06 M1-M2-LC) Côté panoramique en option avec augmentation de prix (ajouter au modèle -LE Ej: DGO 06 M1-M2-LE) 230v 60 Hz / 115v 60 Hz (consulter) Miroir supérieur standard Butée avant en méthacrylate standard Température H1

Ver características técnicas en página 125 / See technical data in page 125 / Voir caractéristiques techniques page 125

Modelo	Longitud (con costados)	Área estantes refrigerados m2	Superficie total exposición (TDA)	Volumen neto (L)	Estantes	Potencia frigorífica HC	Consumo nominal HC	Refrigerante HF
Model	Length (with sides)	Refrigerated shelf area m2	Total display area (TDA)	Net volume (L)	Shelves	Cooling capacity HC	Nominal Power HC	Refrigerant HF
	(mm)	Fondo/Depth 0, Fondo/Depth 1, Fondo/Depth 3	Fondo/Depth 0, Fondo/Depth 1, Fondo/Depth 3	Fondo/Depth 0, Fondo/Depth 1, Fondo/Depth 3	Uds. Units	(W)	(W)	
DS 06 H1	685	0,81, 1,08, 1,33	0,83, 0,86, 0,89	239, 336, 403	3	1192	1382	R-290
DS 09 H1	998	1,21, 1,62, 2,00	1,25, 1,30, 1,32	368, 516, 619	3	1528	1713	R-290
DS 12 H1	1310	1,61, 2,16, 2,66	1,62, 1,70, 1,73	480, 671, 805	3	1931	1885	R-290
DS 15 H1	1623	2,02, 2,70, 3,33	2,01, 2,08, 2,14	628, 879, 1055	6	2384	2368	R-290
DS 18 H1	1935	2,42, 3,24, 4,00	2,48, 2,56, 2,61	737, 1032, 1238	6	3056	3026	R-290
DS 25 H1	2560	3,23, 4,33, 5,33	3,18, 3,36, 3,42	959, 1342, 1611	6	3862	3770	R-290

*Modelos en HFC, consultar precio / HFC Models, consult prices / Modèles HFC, consulter prix
 PVP de opcionales incluidos en equipo, no como repuesto / PVP of options included in the equipment, not as a spare part / PVP d'options incluses dans l'équipement, pas en tant que pièce de rechange
 Interior epoxy negro sin incremento de precio / Black epoxy interior without price increase / Intérieur époxy noir sans majoration de prix

Modelo	1 decoración frontal / front decor / décoration frontal	2 Total decoración / Total decor / décoration total	Paragolpes tubo inox / Stainless steel bumper / Pare-chocs en acier inoxydable	Iluminación LED X nivel estantes / LED Lighting X shelves level / Eclairage LED X niveau des étagères	Pre Instalación / Remote Unit / Groupe à distance
DS 06 H1	248 €	441 €	41 €	39 €	-166 €
DS 09 H1	258 €	449 €	59 €	58 €	-223 €
DS 12 H1	272 €	456 €	75 €	75 €	-275 €
DS 15 H1	282 €	462 €	88 €	80 €	-286 €
DS 18 H1	302 €	469 €	108 €	112 €	-327 €
DS 25 H1	312 €	475 €	137 €	151 €	-530 €
DS 31 H1	356 €	480 €	175 €	187 €	-733 €

Características técnicas y constructivas sujetas a variación sin previo aviso. / We reserve the right to change specifications without prior notice. / Sujet technique et la conception de modifications sans préavis.

DS0 06 H1 2.907 €	DS0 09 H1 3.432 €	DS0 12 H1 3.820 €	DS0 15 H1 4.733 €	DS0 18 H1 5.274 €	DS0 25 H1 5.820 €
DS1 06 H1 2.963 €	DS1 09 H1 3.478 €	DS1 12 H1 3.889 €	DS1 15 H1 4.795 €	DS1 18 H1 5.325 €	DS1 25 H1 5.923 €
DS3 06 H1 3.122 €	DS3 09 H1 3.637 €	DS3 12 H1 4.049 €	DS3 15 H1 5.062 €	DS3 18 H1 5.463 €	DS3 25 H1 6.080 €

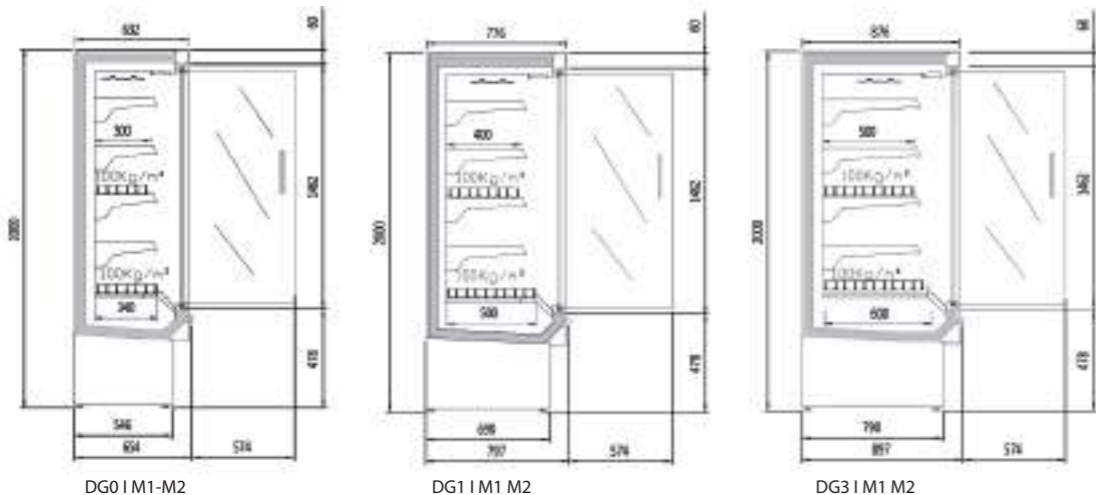

DG0 I M1-M2

DG1 I M1 M2

DG3 I M1 M2

CARACTERÍSTICAS TÉCNICAS

- Modelo INOX: Exterior e interior en acero inox.
- Lateral ventana INOX de serie (LV)
- 230v 60 Hz / 115v 60 Hz (consultar)

TECHNICAL DATA

- Inox Model: Exterior and interior in stainless steel.
- Side windows INOX as standard (LV)
- 230v 60 Hz / 115v 60 Hz (consult)

CARACTÉRISTIQUES TECHNIQUES

- Modèle INOX: Extérieur et intérieur en acier inoxydable
- Côté fenetre INOX en standard (LV)
- 230v 60 Hz / 115v 60 Hz (consulter)

Ver características técnicas en página 125 / See technical data in page 125 / Voir caractéristiques techniques page 125

Modelo	Longitud (con costados)	Área estantes refrigerados	Superficie total exposición	Volumen neto	Estantes	Puertas	Potencia frigorífica HC	Consumo nominal HC	Refrigerante HC
Model	Length (with sides)	Refrigerated shelf area	Total display area	Net volume	Shelves	Doors	Cooling capacity HC	Nominal Power HC	Refrigerant HC
	(mm)	m2	(TDA)	(L)	Uds. Units	Uds. Units	(W)	(W)	
DG0 06 I M1-M2	685	1,00	0,73	255	4	1	555	1132	R-290
DG0 09 I M1-M2	998	1,50	1,11	392	4	2	1192	1494	R-290
DG0 12 I M1-M2	1310	2,00	1,46	510	4	2	1192	1508	R-290
DG0 15 I M1-M2	1623	2,50	1,77	668	8	2	1419	1635	R-290
DG0 18 I M1-M2	1935	3,00	2,19	784	8	3	1528	1945	R-290
DG0 25 I M1-M2	2560	4,00	2,90	1020	8	4	2384	2612	R-290
DG1 06 I M1-M2	685	1,34	0,76	357	4	1	555	1132	R-290
DG1 09 I M1-M2	998	2,00	1,15	549	4	2	1192	1494	R-290
DG1 12 I M1-M2	1310	2,68	1,50	714	4	2	1192	1508	R-290
DG1 15 I M1-M2	1623	3,34	1,83	935	8	2	1419	1635	R-290
DG1 18 I M1-M2	1935	4,01	2,24	1098	8	3	1528	1945	R-290
DG1 25 I M1-M2	2560	5,35	2,94	1428	8	4	2384	2612	R-290
DG3 06 I M1-M2	685	1,65	0,78	428	4	1	555	1132	R-290
DG3 09 I M1-M2	998	2,47	1,17	659	4	2	1192	1494	R-290
DG3 12 I M1-M2	1310	3,30	1,52	857	4	2	1192	1508	R-290
DG3 15 I M1-M2	1623	4,12	1,88	1122	8	2	1419	1635	R-290
DG3 18 I M1-M2	1935	4,95	2,29	1317	8	3	1528	1945	R-290
DG3 25 I M1-M2	2560	6,60	2,99	1714	8	4	2384	2612	R-290

*Modelos en HFC, consultar precio / HFC Models, consult prices / Modèles HFC, consulter prix

PVP de opcionales incluidos en equipo, no como repuesto / PVP of options included in the equipment, not as a spare part / PVP d'options incluses dans l'équipement, pas en tant que pièce de rechange

Interior epoxy negro sin incremento de precio / Black epoxy interior without price increase / Intérieur époxy noir sans majoration de prix

OPCIONES · OPTIONS · OPTIONS

Modelo	Topo estante metacrilato	Paragolpes tubo inox	Iluminación LED X nivel estantes	Pre Instalación
Model	Methacrylate shelf stopper	Stainless steel bumper	LED Lighting X shelves level	Remote Unit
Modèle	Butée d'étagère en méthacrylate	Pare-chocs en acier inoxydable	Eclairage LED X niveau des étagères	Groupe à distance
DG 06 I H1	30 €	41 €	39 €	-166 €
DG 09 I H1	35 €	59 €	58 €	-223 €
DG 12 I H1	38 €	75 €	75 €	-275 €
DG 15 I H1	40 €	88 €	80 €	-286 €
DG 18 I H1	56 €	108 €	112 €	-327 €
DG 25 I H1	66 €	137 €	151 €	-530 €

Características técnicas y constructivas sujetas a variación sin previo aviso. / We reserve the right to change specifications without prior notice. / Sujet technique et la conception de modifications sans préavis.

VITRINA EXPOSITORA MURAL GAMA CEDAR CERRADA M1-M2 INOX
MULTIDECK DISPLAY CEDAR RANGE CLOSED M1-M2 INOX - MUREAUX GAMME CEDAR FERMÉ M1-M2 INOX

Costado ventana opcional
Optional windows side
Côté fenetre en option

4000K 3000K RED FRESH



Lateral modelo cerrado LC
Model closed side LC
Côté fermé modèle LC



DG3 12 M1-M2 INOX

Led vertical incluido en precio
Vertical led included in price
Led verticale incluse dans le prix

Paragolpes tubo inox opcional
Optional stainless steel bumper
Pare-chocs en acier inoxydable en option

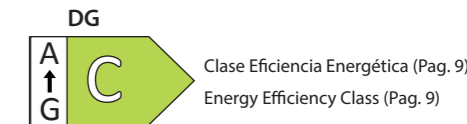

Clase Eficiencia Energética (Pag. 9)
Energy Efficiency Class (Pag. 9)

Mismo precio modelos LC y LV / Same price models LC and LV / Même prix modèles LC et LV

Mismo precio modelos M1 y M2 / Same price models M1 and M2 / Même prix modèles M1 et M2

Laterales incluidos en PVP / Sides included in PVP / Latéraux inclus dans PVP

DG0 06 I M 4.106 €	DG0 09 I M 4.811 €	DG0 12 I M 5.276 €	DG0 15 I M 5.958 €	DG0 18 I M 6.156 €	DG0 25 I M 8.953 €
DG1 06 I M 4.359 €	DG1 09 I M 5.110 €	DG1 12 I M 5.606 €	DG1 15 I M 6.646 €	DG1 18 I M 7.444 €	DG1 25 I M 9.276 €
DG3 06 I M 4.542 €	DG3 09 I M 5.335 €	DG3 12 I M 5.908 €	DG3 15 I M 6.823 €	DG3 18 I M 7.744 €	DG3 25 I M 9.443 €

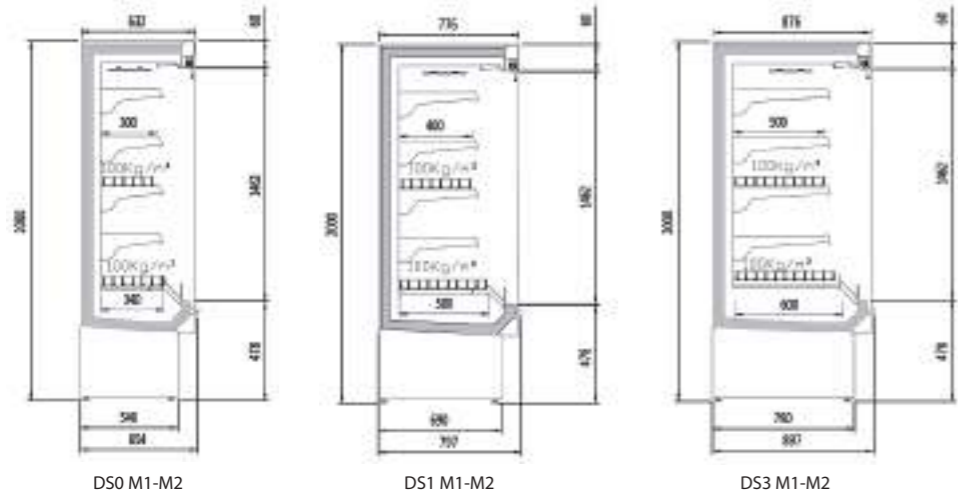

Detalle persiana superior
Upper blind detail
Détail du store supérieur



Modelo con persiana altura 2190mm
Model with blind height 2190mm
Modèle avec hauteur de store 2190 mm



4000K

3000K

RED FRESH

CARACTERÍSTICAS TÉCNICAS	TECHNICAL DATA	CARACTÉRISTIQUES TECHNIQUES
<ul style="list-style-type: none"> Modelo INOX: Exterior e interior en acero inox. Lateral cerrado INOX de serie 230v 60 Hz / 115v 60 Hz (consultar) 	<ul style="list-style-type: none"> Inox Model: Exterior and interior in stainless steel. Side closed INOX as standard 230v 60 Hz / 115v 60 Hz (consult) 	<ul style="list-style-type: none"> Modèle INOX: Extérieur et intérieur en acier inoxydable Côté ferme INOX en standard 230v 60 Hz / 115v 60 Hz (consulter)

Ver características técnicas en página 125 / See technical data in page 125 / Voir caractéristiques techniques page 125



Lateral modelo cerrado LC
Model closed side LC
Côté fermé modèle LC

Modelo	Longitud (con costados)	Área estantes refrigerados	Superficie total exposicion	Volumen neto	Estantes	Puertas	Potencia frigorífica HC	Consumo nominal HC	Refrigerante HC
Model	Length (with sides)	Refrigerated shelf area	Total display area	Net volume	Shelves	Doors	Cooling capacity HC	Nominal Power HC	Refrigerant HC
	(mm)	m2	(TDA)	(L)	Uds. Units	Uds. Units	(W)	(W)	
DS0 06 I M1-M2	685	1,00	0,84	255	4	-	1192	1382	R-290
DS0 09 I M1-M2	998	1,50	1,27	392	4	-	1528	1713	R-290
DS0 12 I M1-M2	1310	2,00	1,64	510	4	-	1931	1885	R-290
DS0 15 I M1-M2	1623	2,50	2,03	668	8	-	2384	2368	R-290
DS0 18 I M1-M2	1935	3,00	2,50	784	8	-	3056	3026	R-290
DS0 25 I M1-M2	2560	4,00	3,20	1020	8	-	3862	3770	R-290
DS1 06 I M1-M2	685	1,34	0,87	357	4	-	1192	1382	R-290
DS1 09 I M1-M2	998	2,00	1,32	549	4	-	1528	1713	R-290
DS1 12 I M1-M2	1310	2,68	1,72	714	4	-	1931	1885	R-290
DS1 15 I M1-M2	1623	3,34	2,10	935	8	-	2384	2368	R-290
DS1 18 I M1-M2	1935	4,01	2,58	1098	8	-	3056	3026	R-290
DS1 25 I M1-M2	2560	5,35	3,38	1428	8	-	3862	3770	R-290
DS3 06 I M1-M2	685	1,65	0,90	428	4	-	1192	1382	R-290
DS3 09 I M1-M2	998	2,47	1,34	659	4	-	1528	1713	R-290
DS3 12 I M1-M2	1310	3,30	1,75	857	4	-	1931	1885	R-290
DS3 15 I M1-M2	1623	4,12	2,16	1122	8	-	2384	2368	R-290
DS3 18 I M1-M2	1935	4,95	2,63	1317	8	-	3056	3026	R-290
DS3 25 I M1-M2	2560	6,60	3,44	1714	8	-	3862	3770	R-290

*Modelos en HFC, consultar precio / HFC Models, consult prices / Modèles HFC, consulter prix
PVP de opcionales incluidos en equipo, no como repuesto / PVP of options included in the equipment, not as a spare part / PVP d'options incluses dans l'équipement, pas en tant que pièce de rechange
Interior epoxy negro sin incremento de precio / Black epoxy interior without price increase / Intérieur époxy noir sans majoration de prix

Modelo	Topo estante metacrilato	Paragolpes tubo inox	Iluminación LED X nivel estantes	Persiana manual	Pre Instalación
Model	Methacrylate shelf stopper	Stainless steel bumper	LED Lighting X shelves level	Manual blind	Remote Unit
Modèle	Butée d'étagère en méthacrylate	Pare-chocs en acier inoxydable	Eclairage LED X niveau des étagères	Store manuel	Groupe à distance
DS 06 I H1	30 €	41 €	39 €	453 €	-166 €
DS 09 I H1	35 €	59 €	58 €	480 €	-223 €
DS 12 I H1	38 €	75 €	75 €	520 €	-275 €
DS 15 I H1	40 €	88 €	80 €	561 €	-286 €
DS 18 I H1	56 €	108 €	112 €	615 €	-327 €
DS 25 I H1	66 €	137 €	151 €	-	-530 €

Características técnicas y constructivas sujetas a variación sin previo aviso. / We reserve the right to change specifications without prior notice. / Sujet technique et la conception de modifications sans préavis.

DS1 251-LV M1-M2 INOX

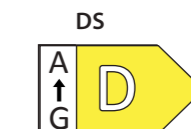

Clase Eficiencia Energética (Pag. 9)
Energy Efficiency Class (Pag. 9)

Mismo precio modelos M1 y M2 / Same price models M1 and M2 / Même prix modèles M1 et M2

Laterales incluidos en PVP / Sides included in PVP / Latéraux inclus dans PVP

DS0 06 I M 3.189 €	DS0 09 I M 3.642 €	DS0 12 I M 4.257 €	DS0 15 I M 5.042 €	DS0 18 I M 5.700 €	DS0 25 I M 7.088 €
DS1 06 I M 3.460 €	DS1 09 I M 3.951 €	DS1 12 I M 4.618 €	DS1 15 I M 5.470 €	DS1 18 I M 6.290 €	DS1 25 I M 7.691 €
DS3 06 I M 3.708 €	DS3 09 I M 4.151 €	DS3 12 I M 4.850 €	DS3 15 I M 5.578 €	DS3 18 I M 6.545 €	DS3 25 I M 7.804 €

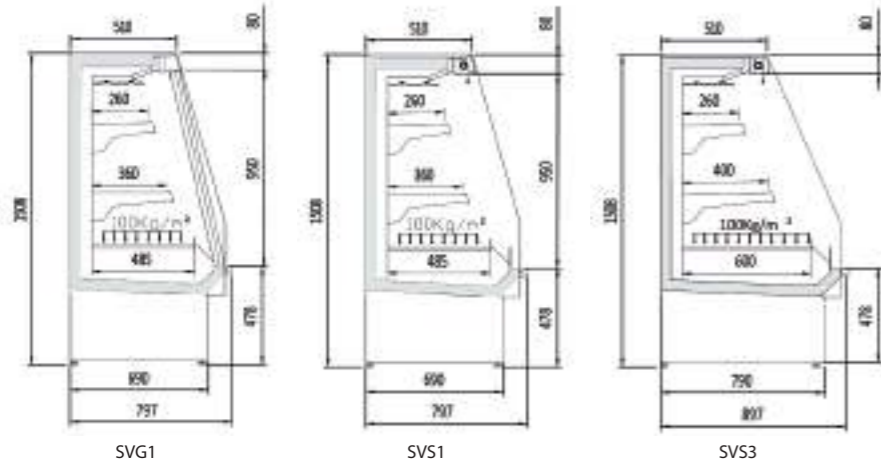

Decoración exterior total blanco, negro o gris RAL 7024 sin incremento de precio
Total exterior decoration white, black or gray RAL 7024 without price increase
Décoration extérieure totale blanc, noir ou gris RAL 7024 sans majoration de prix



4000K 3000K RED FRESH



Puertas doble cristal correderas
Sliding double glass doors
Portes coulissantes à double vitrage



Costado panorámico de serie
Panoramic side as standard
Côté panoramique de série

Modelo	Longitud (con costados) mm	Área estantes refrigerados m2	Superficie total exposicion (TDA)	Volumen neto (L)	Estantes (Uds.)	Puertas (Uds.)	Potencia frigorífica (W)	Consumo nominal (W)	Refrigerante
Model	Length (with sides) mm	Refrigerated shelf area m2	Total display area (TDA)	Net volume (L)	Shelves (units)	Doors (units)	Cooling capacity (W)	Nominal power (W)	Refrigerant
MODELOS CON PUERTAS / MODELS WITH DOORS / MODÈLES AVEC PORTES									
SVG1 09 M1	998	1,01	0,79	330	2	2	1192	1557	R-290
SVG1 12 M1	1310	1,35	1,09	421	2	2	1192	1639	R-290
SVG1 18 M1	1935	2,02	1,64	662	4	3	1528	1945	R-290
MODELOS SIN PUERTAS / MODELS WITHOUT DOORS / MODÈLES SANS PORTES									
SVS1 06 M2	685	0,67	0,57	212	2	-	1192	1382	R-290
SVS1 09 M2	998	1,01	0,80	330	2	-	1528	1713	R-290
SVS1 12 M2	1310	1,35	1,10	421	2	-	1931	1885	R-290
SVS1 15 M2	1623	1,69	1,35	564	4	-	2384	2368	R-290
SVS1 18 M2	1935	2,02	1,66	662	4	-	3056	3026	R-290
SVS3 06 M2	685	0,77	0,61	254	2	-	1192	1382	R-290
SVS3 09 M2	998	1,15	0,90	396	2	-	1528	1713	R-290
SVS3 12 M2	1310	1,54	1,21	505	2	-	1931	1885	R-290
SVS3 15 M2	1623	1,92	1,52	677	4	-	2384	2368	R-290
SVS3 18 M2	1935	2,32	1,81	794	4	-	3056	3026	R-290

230v 60Hz / 115v 60Hz. consultar - consult - consulter

Ver características técnicas en página 125 / See technical data in page 125 / Voir caractéristiques techniques page 125

*Modelos en HFC, consultar precio / HFC Models, consult prices / Modèles HFC, consulter prix

PVP de opcionales incluidos en equipo, no como repuesto / PVP of options included in the equipment, not as a spare part / PVP d'options incluses dans l'équipement, pas en tant que pièce de rechange

Interior epoxy negro sin incremento de precio / Black epoxy interior without price increase / Intérieur époxy noir sans majoration de prix

OPCIONES · OPTIONS · OPTIONS

Modelo	1 decoración frontal / front decor / décoration frontal	2 Total decoración / Total decor / décoration total	Tope estante metacrilato	Paragolpes tubo inox	Iluminación LED X nivel estantes	Pre Instalación
Model			Methacrylate shelf stopper	Stainless steel bumper	LED Lighting X shelves level	Remote Unit
Modèle			Butée d'étagère en méthacrylate	Pare-chocs en acier inoxydable	Eclairage LED X niveau des étagères	Groupe à distance
SVG / SVS 06	248 €	441 €	30 €	41 €	39 €	-166 €
SVG / SVS 09	258 €	449 €	35 €	59 €	58 €	-223 €
SVG / SVS 12	272 €	456 €	38 €	75 €	75 €	-275 €
SVG / SVS 15	282 €	462 €	40 €	88 €	80 €	-286 €
SVG / SVS 18	302 €	469 €	56 €	108 €	112 €	-327 €

Características técnicas y constructivas sujetas a variación sin previo aviso. / We reserve the right to change specifications without prior notice. / Sujet technique et la conception de modifications sans préavis.

SVS1 12



Clase Eficiencia Energética (Pag. 9)
Energy Efficiency Class (Pag. 9)

Laterales incluidos en PVP / Sides included in PVP / Latéraux inclus dans PVP

 SVS1 06 M2 2.580 €	 SVS1 09 M2 2.990 €	 SVS1 12 M2 3.165 €	 SVS1 15 M2 4.035 €	 SVS1 18 M2 4.055 €
 SVS3 06 M2 2.630 €	 SVS3 09 M2 3.005 €	 SVS3 12 M2 3.300 €	 SVS3 15 M2 3.941 €	 SVS3 18 M2 4.072 €
 SVG1 09 M1 4.311 €	 SVG1 12 M1 4.576 €	 SVG1 18 M1 5.685 €		



Lateral modelo cerrado LC
(Sin incremento PVP)

Model cosed side LC
(No PVP increase)

Côté fermé modelé LC
(Pas d'augmentation PVP)



Lateral modelo ventana LV
(Sin incremento PVP)

Model windows side LV
(No PVP increase)

Côté modelé fenetre LV
(Pas d'augmentation PVP)



Lateral modelo panorámico LE

Model panoramic side LE

Côté panoramique modelé LE

LE **933 €**



Lateral modelo plástico (De serie)

Model plastic side (As standard)

Côté plastique modelé (En série)



Pincho - Spike - Pic

44 €



Gancho - Hook - Accocher

35 €



Separador genero
Product separator
séparateur de genre

49 €



Separador ambiente
Ambient separator
séparateur de ambient

250 €



Barras carniceras - Butcher bars - Barres de boucherie
Consultar - Consult - Consulter



Frente metacrilato - Methacrylate front - Façade en méthacrylate

Modelo Model Modèle	Tope estante metacrilato Methacrylate shelf stopper Butée d'étagère en méthacrylate
DG3 / DS3 06	30 €
DG3 / DS3 09	35 €
DG3 / DS3 12	38 €
DG3 / DS3 15	40 €
DG3 / DS3 18	56 €
DG3 / DS3 25	66 €
DG3 31	80 €

Detalle opcionales - optional detail - Détail en option

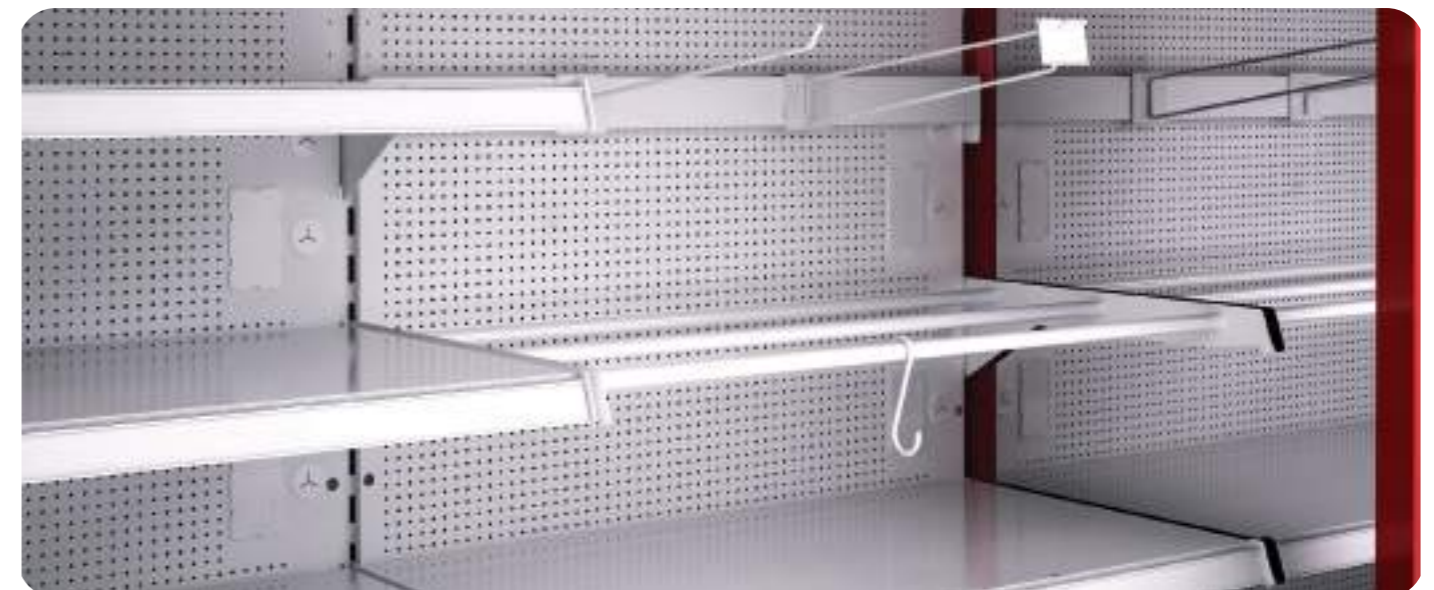

4 LINEA SUPERMERCADOS

LINE SUPERMARKET
LIGNE SUPERMARCHÉ



CLOVER Página 151
Vitrina mural preinstalación
Multideck display preinstallation
Mureaux préinstallation



AZALEA Página 195
Vitrina mural grupo incorporado
Multideck display plug-in
Mureaux groupe intégré



LIME Página 171
Vitrina mural preinstalación
Multideck display preinstallation
Mureaux préinstallation



VIS Página 197
Vitrina semi mural minimarket
Multideck display minimarket
Mureaux minimarket



CYPRESS Página 173
Vitrina mural preinstalación
Multideck display preinstallation
Mureaux préinstallation



DUMD Página 203
Expositor congelados
Frozen exhibitor
Congelés exposant



MAGNOLIA Página 175
Armario minimarket
Minimarket cabinet
Armoire minimarket



DBNP Página 205
Mostrador pescado
Island serve over counter
Vitrine island



SVEST-12 / VE-12
Página 177
Vitrina expositora
Serve over counter
Vitrine exposant



UNIDADES CONDESADORAS
Página 207
Equipos condensadores a distancia
Remote condenser
Condenseurs a distance



EFIMARKET  Página 183
Armario minimarket
Minimarket cabinet
Armoire minimarket

VITRINAS MURALES

CARACTERÍSTICAS TÉCNICAS

- Mueble vertical para conectar a unidad motocondensadora o central frigorífica con capacidad y visibilidad optimizada del producto
- Modelo RMS: Cortina de noche manual y frente cuba inferior de metacrilato
- Modelo RMG: Puertas abatibles de vidrio con serigrafía mínima, apertura permitida hasta 93° y bloqueo de cierre manual. Autocierre con barra de torsión
- Exterior: En color negro RAL 9005, franja superior e inferior personalizable a elegir colores disponibles
- Interior pintado en epoxi blanco RAL 9003
- Desagüe con sifón 40mm de diámetro
- Salida de tuberías: posibilidad por parte inferior, superior o trasera
- Evaporador HFC con recubrimiento anticorrosión acabado epoxi
- Juego de válvula solenoide y de expansión termostática R-449A / R-448A u opción R-134a
- Estantes regulables en altura y ángulo, con portaprecios de 40 mm incluidos
- Desescarche natural del evaporador
- Ventiladores electromecánicos, opcional electrónicos
- Control electrónico con sonda de ambiente y descarche
- Iluminación LED 24v 4000k en visera y montantes (sólo modelos RMG)
- Temperatura de producto, según EN-ISO-23953:
 - M1: -1°+5°C, apropiado para carnes.
 - M2: -1°+7°C, apropiado para lácteos, delis y embutidos
 - H1: +1°+10°C, apropiado para frutas y verduras.
- Clase climática 3 (25°C, 60 H.R)
- Laterales no incluidos en el precio, espesor 30mm
- El paragolpes de tubo es opcional en todos los modelos (no incluido de serie)
- Se recomienda canalizar el agua de descarche hasta acometida de aguas.
- Refrigeración por otros gases: CONSULTAR

MULTIDECK DISPLAY

COMMON TECHNICAL

- Vertical remote cabinet ready to connect to condensing unit or refrigeration plant with optimized capacity and visibility of the product
- RMS Model: Manual night blind and and inferior exposition deck perspex
- DG model: Glass folding doors with minimum screen printing, allowed opening up to 93° and manual closing lock. Self-closing with torsion bar
- As standard: plinth in colour RAL 9005, inferior and superior decorative customizable to choose available colors
- Interior painted in white epoxy RAL 9003
- Drain with siphon 40mm diameter
- Pipe outlet: possibility by bottom, top or backrest
- HFC evaporator with epoxy finish anti-corrosion coating
- R-449A / R-448A or option R-134a solenoid and thermostatic expansion valves kit
- Adjustable shelves in height and angle, with 40 mm price holders included
- Natural defrost of evaporator
- Electromechanic fans, optional electronics
- Electronic control with room probe and defrost
- 24v LED lighting on vertical frame (only RMG models) and superior 4000k colour
- Product temperature, according to EN-ISO-23953:
 - M1: -1°+5°C, suitable for meat
 - M2: -1°+7°C, suitable for dairy products, delis and sausages
 - H1: +1°+10°C, suitable for fruits and vegetables
- Climatic class 3 (25°C, 60 H.R)
- Sides not included in the price, thickness 30mm
- Stainless steel bumper is an optional in every model (standard not included)
- It is recommended to channel the defrost water to water supply
- Cooling by other gases: CONSULT

VITRINE MUREAUX

CARACTÉRISTIQUES TECHNIQUES

- Armoire verticale à connecter à un condenseur ou une unité de réfrigération avec une capacité et une visibilité optimisées du produit
- Modèle RMS: store de nuit manuel et avant du réservoir inférieur en méthacrylate
- Modèle DG: Portes pliantes en verre avec sérigraphie minimale, ouverture autorisée jusqu'à 93 ° et serrure à fermeture manuelle. Fermeture automatique avec barre de torsion
- Exterieur: base inférieure en RAL 9005, bande supérieure et inférieure en tôle personnalisable pour choisir les couleurs disponibles
- Intérieur peint en epoxy blanc RAL 9003
- Vidange avec siphon diamètre 40mm
- Sortie de tuyau: possibilité de bas, haut ou arrière
- Évaporateur HFC avec revêtement anticorrosion finition epoxy
- Kit solénoïde et détendeur thermostatique R-449A / R-448A ou option R-134°
- Tablettes réglables en hauteur et en angle, avec support de prix de 40 mm inclus
- Dégivrage naturel de l'évaporateur
- Ventilateurs électromécaniques, électroniques en option
- Commande électronique avec sonde d'ambiance et dégivrage
- Éclairage LED 24v 4000k sur la visière et les piliers (modèles RMG uniquement)
- Température du produit, selon EN-ISO-23953:
 - M1: -1° + 5°C, convient aux viandes.
 - M2: -1° + 7°C, convient aux produits laitiers, épicerie fines et saucisses
 - H1: + 1° + 10°C, convient aux fruits et légumes.
- Classe climatique 3 (25 ° C, 60 H.R)
- Côtés non inclus dans le prix, 30mm épaisseur
- Le pare-chocs tubulaire est en option sur tous les modèles (non inclus en standard)
- Est recommandé de canaliser l'eau de dégivrage vers le raccordement
- Réfrigération par d'autres gaz: CONSULTER

VITRINAS EXPOSITORAS

CARACTERÍSTICAS TÉCNICAS SVEST-12

- Vitrina remota de servicio asistido para conectar a unidad motocondensadora o central frigorífica.
- Cristal frontal templado securizado elevable
- Encimera de trabajo en acero inoxidable AISI-304
- Sin estante de cristal intermedio
- Perfilería en aluminio anodizado
- Exterior: zócalo inferior en RAL 9005, franja superior e inferior en chapa a elegir de colores disponibles
- Interior pintado en epoxi blanco RAL 9003
- Salida de tuberías por parte inferior
- Evaporador HFC con recubrimiento anticorrosión acabado epoxi
- Juego de válvula solenoide y de expansión termostática R-449A / R-448A o R-134a
- Desescarche natural del evaporador
- Ventiladores electromecánicos
- Control electrónico e indicador de temperatura en parte delantera de plano de exposición
- Iluminación LED 24v 4000k en encimera superior
- Temperatura de producto, según EN-ISO-23953:
 - M1: -1°+5°C, apropiado para carnes y embutidos
 - Clase climática 4 (30°C, 55 %H.R)
- Laterales ABS no incluidos en el precio (espesor 30mm), opcional panorámicos (espesor 20mm)
- El paragolpes de tubo es opcional en todos los modelos (no incluido de serie)
- Se recomienda canalizar el agua de descarche hasta acometida de aguas
- Refrigeración por otros gases: CONSULTAR

SERVE OVER COUNTER

TECHNICAL DATA SVEST-12

- Serve over counter ready to connect to condensing unit or refrigeration plant
- Tempered securized liftable frontal glass
- Worktop in stainless steel AISI 304
- Without intermediate glass shelf
- Anodized aluminum profiling
- As standard: plinth in colour RAL 9005, inferior and superior decorative stripe choose from available colours
- Interior painted in white epoxy RAL 9003
- Pipe outlet by bottom
- HFC evaporator with epoxy finish anti-corrosion coating
- R-449A / R-448A or R-134a solenoid and thermostatic expansion valves kit
- Adjustable shelves in height and angle, with 40 mm price holders included
- Natural defrost of evaporator
- Electromechanic fans
- Electronic control and temperature indicator in exposition deck
- 24v LED lighting on superior worktop in 4000k colour
- Product temperature, according to EN-ISO-23953:
 - M1: -1°+5°C, suitable for meat and sausages
 - Climatic class 4 (30°C, 55% H.R)
- Side view not included in the price (thickness 30mm), optional panoramic (thickness 20mm)
- Stainless steel bumper is an optional in every model (standard not included)
- It is recommended to channel the defrost water to water supply or automatic
- Cooling by other gases: CONSULT

VITRINE RÉFRIGÉRÉ

CARACTÉRISTIQUES TECHNIQUES SVEST-12

- Vitrine de service assistée à distance pour se connecter à un condenseur ou une unité de réfrigération.
- Verre avant trempé de sécurité relevable
- Plan de travail en acier inoxydable AISI-304
- Pas d'étagère en verre intermédiaire
- Profilés en aluminium anodisé
- Exterieur: base inférieure en RAL 9005, bande supérieure et inférieure en tôle au choix parmi les couleurs disponibles
- Intérieur peint en epoxy blanc RAL 9003
- Sortie de tuyau par le bas
- Évaporateur HFC avec revêtement anticorrosion finition epoxy
- Kit d'expansion thermostatique et d'électrovanne R-449A / R-448A ou R-134a
- Dégivrage naturel de l'évaporateur
- Ventilateurs électromécaniques
- Contrôle électronique et indicateur de température devant le plan d'exposition
- Éclairage LED 24v 4000k sur le comptoir supérieur
- Température du produit, selon EN-ISO-23953:
 - M1: -1° + 5°C, convient à la viande et aux saucisses
 - Classe climatique 4 (30 ° C, 55% H.R.)
- Vue latérale non incluse dans le prix (épaisseur 30 mm), panoramique en option (épaisseur 20 mm)
- Le pare-chocs tubulaire est en option sur tous les modèles (non inclus en standard)
- Il est recommandé de canaliser l'eau de dégivrage vers le raccordement d'eau ou le bac
- Réfrigération par d'autres gaz: CONSULTER

Para acabados exteriores en alto brillo, fluorescentes, luminiscentes, consultar precio
 For exterior finishes in high gloss, fluorescent, luminescent, consult price
 Pour finitions extérieures en brillant, fluorescent, luminescent, consulter le prix

CARTA DE ACABADOS

COLOR · COULEUR

RAL-9003	RAL-9005	RAL-4010	RAL-5003	
RAL-2011	PANTONE 7606C	PANTONE 543C	PANTONE 2298C	PANTONE 7604C
RAL-1018	RAL-3015	PANTONE 5523C	RAL-5023	PANTONE 5865
DECORACIÓN INOX	RAL 7024	RAL-6001	PANTONE 4725C	PANTONE 2408C
WENGUE	NOGAL	ROBLE	HAYA	RAL-3020



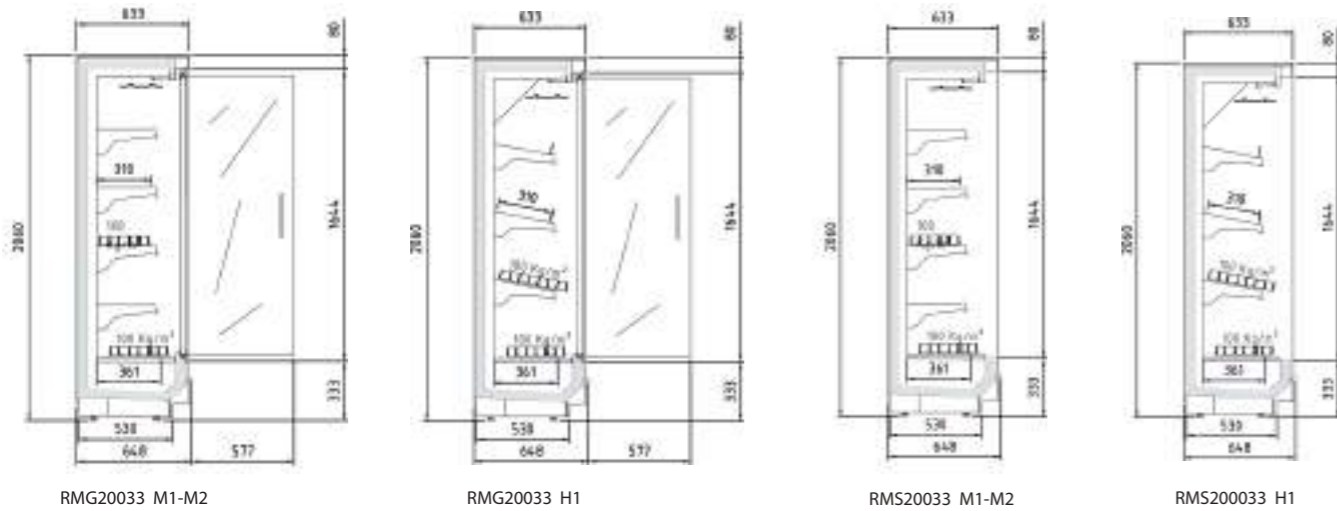

Iluminación led vertical de serie
Standard vertical led lighting

Puertas doble vidrio transparente
Transparent double glass door



RMG20033 18 M1-M2

Ver características técnicas en página 148 / See technical data in page 148 / Voir caractéristiques techniques page 148

Modelo	Longitud (sin costados)	Área estantes refrigerados m2	Superficie total exposición (TDA)	Volumen neto (L)	Estantes	Puertas
Model	Length (without sides)	Refrigerated shelf area m2	Total display area (TDA)	Net volume (L)	Shelves	Doors
Modelé	Longueur (sans côtés)	Zone d'étagères réfrigérées	Surface totale d'exposition (TDA)	Volume net (L)	Étagères	Portes
	(mm)	Fondo/ Depth 0	Fondo/ Depth 0	Fondo/ Depth 0	Uds. Units	Uds. Units
RMG20033 12 M1-M2	1250	1,99	1,76	553	4	2
RMG20033 18 M1-M2	1875	2,99	2,64	830	8	3
RMG20033 25 M1-M2	2500	3,99	3,52	1106	8	4
RMG20033 37 M1-M2	3750	5,98	5,60	1659	12	6
RMG20033 12 H1	1250	1,60	1,74	479	3	2
RMG20033 18 H1	1875	2,41	2,61	718	6	3
RMG20033 25 H1	2500	3,21	3,47	958	6	4
RMG20033 37 H1	3750	4,81	5,52	1437	9	6
RMS20033 12 M1-M2	1250	1,99	1,97	553	4	-
RMS20033 18 M1-M2	1875	2,99	2,96	830	8	-
RMS20033 25 M1-M2	2500	3,99	3,94	1106	8	-
RMS20033 37 M1-M2	3750	5,98	5,91	1659	12	-
RMS20033 12 H1	1250	1,60	1,97	479	3	-
RMS20033 18 H1	1875	2,41	3,17	718	6	-
RMS20033 25 H1	2500	3,21	4,22	958	6	-
RMS20033 37 H1	3750	4,81	6,33	1437	9	-



Costado ventana
Window side



RMS20033 25 M1

Paragolpes de tubo en acero inoxidable opcional
Optional stainless steel bumper tube



RMG
A ↑ B
G ↓

Clase Eficiencia Energética (Pag. 9)
Energy Efficiency Class (Pag. 9)

RMS
A ↑ D
G ↓

Clase Eficiencia Energética (Pag. 9)
Energy Efficiency Class (Pag. 9)

PVP de opcionales incluidos en equipo, no como repuesto / PVP of options included in the equipment, not as a spare part / PVP d'options incluses dans l'équipement, pas en tant que pièce de rechange
 Interior epoxy negro sin incremento de precio / Black epoxy interior without price increase / Intérieur époxy noir sans majoration de prix

OPCIONES · OPTIONS · OPTIONS

Modelo	Exterior lacado	Costado lacado Ciego / Visión (1 Ud)	Costado lacado Panorámico (1 Ud)	Kit ventiladores electronicos	Kit espejo superior	Paragolpes tubo inox (€ / m)	Tope estante metacrilato (X nivel de estante)	Iluminación LED (X nivel de estante)
Model	Lacquered exterior	Lacquered side Blind / Vision (1 Ud)	Lacquered side Panoramic (1 Ud)	Kit electronic ventilators	Top kit mirror	Stainless steel bumper (€ / m)	Methacrylate shelf stop (X nivel de estante)	LED Lighting (X level shelf)
Modèle	Extérieur laqué	Côté laqué Aveugle / Vision (1 Ud)	Côté laqué Panoramique (1 Ud)	Kit électronique ventilateurs	Top kit miroir	Pare-chocs acier inoxydable(€ / m)	Butée d'étagère méthacrylate (X nivel de estante)	Eclairage LED (X niveau d'étagère)
RMG033 12	173 €	155 €	80 €	81 €	84 €	75 €	34 €	77 €
RMG033 18	207 €	155 €	80 €	124 €	116 €	108 €	56 €	115 €
RMG033 25	303 €	155 €	80 €	164 €	165 €	137 €	66 €	148 €
RMG033 37	345 €	155 €	80 €	247 €	229 €	217 €	99 €	242 €
RMS033 12	173 €	155 €	80 €	81 €	84 €	75 €	34 €	77 €
RMS033 18	207 €	155 €	80 €	124 €	116 €	108 €	56 €	115 €
RMS033 25	303 €	155 €	80 €	164 €	165 €	137 €	66 €	148 €
RMS033 37	345 €	155 €	80 €	247 €	229 €	217 €	99 €	242 €

JUEGO LATERALES CIEGOS BLIND SIDES KIT CÔTÉS AVEUGLE JEU	JUEGO LATERALES VENTANA WINDOWS SIDES KIT CÔTÉS FENÊTRE JEU
LCD 254 €	LVD 254 €
LCI 254 €	LVI 254 €

Laterales NO incluidos en PVP / Sides NOT included in PVP / Latéraux NON inclus dans PVP

RMG20133 12 M 3.896 €	RMG20033 18 M 5.103 €	RMG20033 25 M 6.062 €	RMG20033 37 M 8.152 €	RMS20133 12 M 3.569 €	RMS20133 18 M 4.593 €	RMS20133 25 M 5.456 €	RMS20133 37 M 7.337 €
RMG20133 12 H 3.850 €	RMG20033 18 H 5.192 €	RMG20033 25 H 6.171 €	RMG20033 37 H 8.226 €	RMS20133 12 H 3.465 €	RMS20133 18 H 4.673 €	RMS20133 25 H 5.554 €	RMS20133 37 H 7.404 €

Características técnicas y constructivas sujetas a variación sin previo aviso. / We reserve the right to change specifications without prior notice. / Sujet technique et la conception de modifications sans préavis.

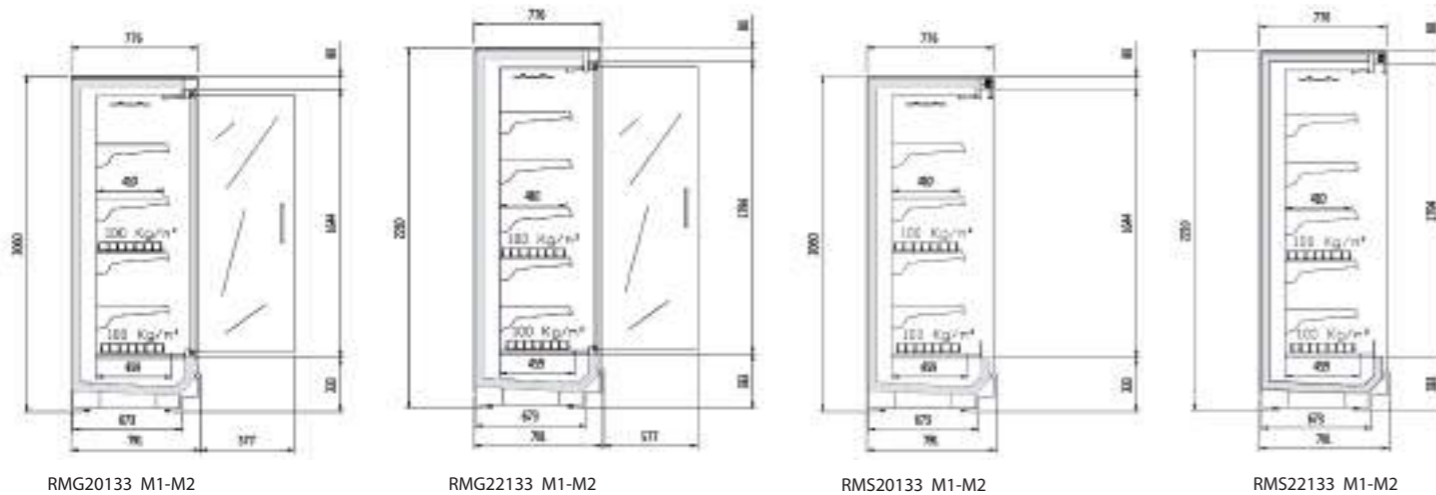

RMG20133 M1-M2 RMG22133 M1-M2 RMS20133 M1-M2 RMS22133 M1-M2

Ver características técnicas en página 148 / See technical data in page 148 / Voir caractéristiques techniques page 148

Modelo	Longitud (sin costados)	Área estantes refrigerados m2	Superficie total exposicion (TDA)	Volumen neto (L)	Estantes	Puertas
Model	Length (without sides)	Refrigerated shelf area m2	Total display area (TDA)	Net volume (L)	Shelves	Doors
Modelé	Longueur (sans côtés)	Zone d'étagères réfrigérées	Surface totale d'exposition (TDA)	Volume net (L)	Étagères	Portes
	(mm)	Fondo/ Depth 0	Fondo/ Depth 0	Fondo/ Depth 0	Uds. Units	Uds. Units
RMG20133 12 M1-M2	1250	2,62	1,76	700	4	2
RMG20133 18 M1-M2	1875	3,94	2,64	1050	8	3
RMG20133 25 M1-M2	2500	5,25	3,52	1400	8	4
RMG20133 37 M1-M2	3750	7,87	5,60	2100	12	6
RMG22133 12 M1-M2	1250	2,11	1,90	683	5	2
RMG22133 18 M1-M2	1875	3,17	2,86	1025	10	3
RMG22133 25 M1-M2	2500	4,22	3,81	1366	10	4
RMG22133 37 M1-M2	3750	6,33	6,05	2049	15	6
RMS20133 12 M1-M2	1250	2,62	1,97	700	4	-
RMS20133 18 M1-M2	1875	3,94	2,96	1050	8	-
RMS20133 25 M1-M2	2500	5,25	3,94	1400	8	-
RMS20133 37 M1-M2	3750	7,87	5,91	2100	12	-
RMS22133 12 M1-M2	1250	3,14	2,16	751	5	-
RMS22133 18 M1-M2	1875	4,70	3,24	1127	10	-
RMS22133 25 M1-M2	2500	6,27	4,32	1503	10	-
RMS22133 37 M1-M2	3750	9,41	6,48	2254	15	-

PVP de opcionales incluidos en equipo, no como repuesto / PVP of options included in the equipment, not as a spare part / PVP d'options incluses dans l'équipement, pas en tant que pièce de rechange
Interior epoxy negro sin incremento de precio / Black epoxy interior without price increase / Intérieur époxy noir sans majoration de prix

OPCIONES · OPTIONS · OPTIONS

Modelo	Exterior lacado	Costado lacado Ciego / Visión (1 Ud)	Costado lacado Panorámico (1 Ud)	Kit ventiladores electronicos	Kit espejo superior	Paragolpes tubo inox (€ / m)	Tope estante metacrilato (X nivel de estante)	Iluminación LED (X nivel de estante)
Model	Lacquered exterior	Lacquered side Blind / Vision (1 Ud)	Lacquered side Panoramic (1 Ud)	Kit electronic ventilators	Top kit mirror	Stainless steel bumper (€ / m)	Methacrylate shelf stop (X nivel de estante)	LED Lighting (X level shelf)
Modèle	Extérieur laqué	Côté laqué Aveugle / Vision (1 Ud)	Côté laqué Panoramique (1 Ud)	Kit électronique ventilateurs	Top kit miroir	Pare-chocs acier inoxydable(€ / m)	Butée d'étagère méthacrylate (X nivel de estante)	Eclairage LED (X niveau d'étagère)
RMG133 12	173 €	155 €	80 €	81 €	84 €	75 €	34 €	77 €
RMG133 18	207 €	155 €	80 €	124 €	116 €	108 €	56 €	115 €
RMG133 25	303 €	155 €	80 €	164 €	165 €	137 €	66 €	148 €
RMG133 37	345 €	155 €	80 €	247 €	229 €	217 €	99 €	242 €
RMS133 12	173 €	155 €	80 €	81 €	84 €	75 €	34 €	77 €
RMS133 18	207 €	155 €	80 €	124 €	116 €	108 €	56 €	115 €
RMS133 25	303 €	155 €	80 €	164 €	165 €	137 €	66 €	148 €
RMS133 37	345 €	155 €	80 €	247 €	229 €	217 €	99 €	242 €

Características técnicas y constructivas sujetas a variación sin previo aviso. / We reserve the right to change specifications without prior notice. / Sujet technique et la conception de modifications sans préavis.

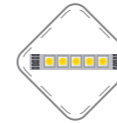

Iluminación led vertical de serie
Standard vertical led lighting



Costado ventana
Window side



RMS20133 25 M1

Laterales NO incluidos en PVP / Sides NOT included in PVP / Latéraux NON inclus dans PVP

MODELO CON PUERTAS ALTO 2060 / MODEL WITH DOORS ALTO 2060 / MODÈLE AVEC PORTES ALTO 2060				MODELO CON PUERTAS ALTO 2210 / MODEL WITH DOORS ALTO 2210 / MODÈLE AVEC PORTES ALTO 2210			
RMG20133 12 M	3.786 €	RMG20133 18 M	5.103 €	RMG20133 25 M	6.062 €	RMG20133 37 M	8.152 €
RMG22133 12 M	3.979 €	RMG22133 18 M	5.370 €	RMG22133 25 M	6.386 €	RMG22133 37 M	8.637 €
MODELO SIN PUERTAS ALTO 2060 / MODEL WITHOUT DOORS ALTO 2060 / MODÈLE SANS PORTES ALTO 2060				MODELO SIN PUERTAS ALTO 2210 / MODEL WITHOUT DOORS ALTO 2210 / MODÈLE SANS PORTES ALTO 2210			
RMS20133 12 M	3.160 €	RMS20133 18 M	4.085 €	RMS20133 25 M	4.683 €	RMS20133 37 M	6.379 €
RMS22133 12 M	3.316 €	RMS22133 18 M	4.290 €	RMS22133 25 M	4.925 €	RMS22133 37 M	6.747 €



RMG20133 18 M1-M2

Paragolpes de tubo en acero inoxidable opcional
Opcional stainless steel bumper tube

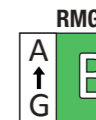

Clase Eficiencia Energética (Pag. 9)
Energy Efficiency Class (Pag. 9)

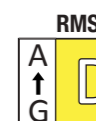

Clase Eficiencia Energética (Pag. 9)
Energy Efficiency Class (Pag. 9)

JUEGO LAT. PANORAMICOS PANORAMIC SIDES KIT CÔTÉS PANORAMIQUE JEU	JUEGO LATERALES CIEGOS BLIND SIDES KIT CÔTÉS AVEUGLE JEU	JUEGO LATERALES VENTANA WINDOWS SIDES KIT CÔTÉS FENÊTRE JEU
LPD20 445 €	LCD 278 €	LVD 278 €
LPI20 445 €	LCI 278 €	LVI 278 €
LPD22 476 €		
LPI22 476 €		

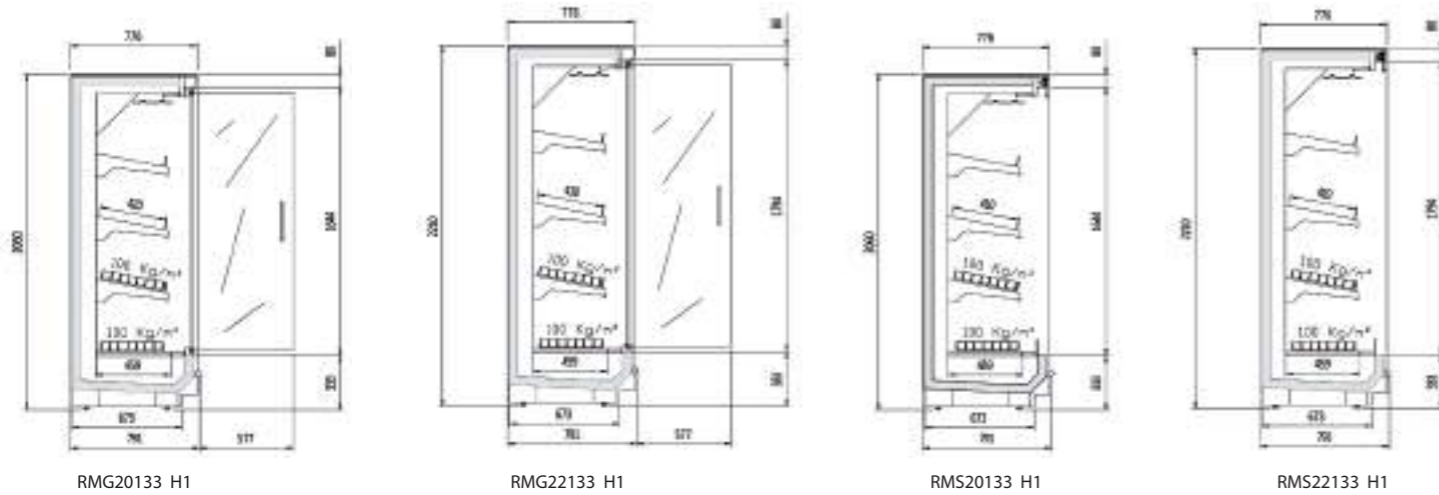

Costado ciego + espejo
Blind side + mirror

Puertas doble vidrio
Double glass doors

Iluminación led vertical de serie
Standard vertical led lighting

Decoración frontal lacado
Lacquered front decoration

Ver características técnicas en página 148 / See technical data in page 148 / Voir caractéristiques techniques page 148

Modelo	Longitud (sin costados) Length (without sides)	Área estantes refrigerados m2 Refrigerated shelf area m2	Superficie total exposición (TDA) Total display area (TDA)	Volumen neto (L) Net volume (L)	Estantes Shelves	Puertas Doors
Model	Longueur (sans côtés) (mm)	Zone d'étagères réfrigérées Fondo/ Depth 0	Surface totale d'exposition (TDA) Fondo/ Depth 0	Volume net (L) Fondo/ Depth 0	Étagères Uds. Units	Portes Uds. Units
RMG20133 12 H1	1250	2,11	1,74	606	3	2
RMG20133 18 H1	1875	3,17	2,61	909	6	3
RMG20133 25 H1	2500	4,22	3,47	1213	6	4
RMG20133 37 H1	3750	6,33	5,52	1819	9	6
RMG22133 12 H1	1250	2,11	1,90	683	3	2
RMG22133 18 H1	1875	3,17	2,86	1025	6	3
RMG22133 25 H1	2500	4,22	3,81	1366	6	4
RMG22133 37 H1	3750	6,33	6,05	2049	9	6
RMS20133 12 H1	1250	2,11	1,97	606	3	-
RMS20133 18 H1	1875	3,17	2,96	909	6	-
RMS20133 25 H1	2500	4,22	3,94	1213	6	-
RMS20133 37 H1	3750	6,33	5,91	1819	9	-
RMS22133 12 H1	1250	2,11	2,16	683	3	-
RMS22133 18 H1	1875	3,17	3,24	1025	6	-
RMS22133 25 H1	2500	4,22	4,32	1366	6	-
RMS22133 37 H1	3750	6,33	6,47	2049	9	-

230v 60Hz / 115v 60Hz. consultar - consult - consulter

PVP de opcionales incluidos en equipo, no como repuesto / PVP of options included in the equipment, not as a spare part / PVP d'options incluses dans l'équipement, pas en tant que pièce de rechange
Interior epoxy negro sin incremento de precio / Black epoxy interior without price increase / Intérieur époxy noir sans majoration de prix

OPCIONES · OPTIONS · OPTIONS

Modelo	Exterior lacado Lacquered exterior	Costado lacado Ciego / Visión (1 Ud) Lacquered side Blind / Vision (1 Ud)	Costado lacado Panorámico (1 Ud) Lacquered side Panoramic (1 Ud)	Kit ventiladores electronicos Kit electronic ventilators	Paragolpes tubo inox (€ / m) Stainless steel bumper (€ / m)	Iluminación LED (X nivel de estante) LED Lighting (X level shelf)
Model	Lacquered exterior	Lacquered side Blind / Vision (1 Ud)	Lacquered side Panoramic (1 Ud)	Kit electronic ventilators	Stainless steel bumper (€ / m)	LED Lighting (X level shelf)
Modèle	Extérieur laqué	Côté laqué Aveugle / Vision (1 Ud)	Côté laqué Panoramique (1 Ud)	Kit électronique ventilateurs	Pare-chocs acier inoxydable(€ / m)	Eclairage LED (X niveau d'étagère)
RMG133 12	173 €	155 €	80 €	81 €	75 €	77 €
RMG133 18	207 €	155 €	80 €	124 €	108 €	115 €
RMG133 25	303 €	155 €	80 €	164 €	137 €	148 €
RMG133 37	345 €	155 €	80 €	247 €	217 €	242 €
RMS133 12	173 €	155 €	80 €	81 €	75 €	77 €
RMS133 18	207 €	155 €	80 €	124 €	108 €	115 €
RMS133 25	303 €	155 €	80 €	164 €	137 €	148 €
RMS133 37	345 €	155 €	80 €	247 €	217 €	242 €

Características técnicas y constructivas sujetas a variación sin previo aviso. / We reserve the right to change specifications without prior notice. / Sujet technique et la conception de modifications sans préavis.

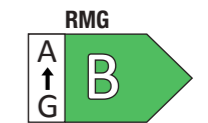

Clase Eficiencia Energética (Pag. 9)
Energy Efficiency Class (Pag. 9)



Clase Eficiencia Energética (Pag. 9)
Energy Efficiency Class (Pag. 9)

RMG20333 18 H1

Paragolpes de tubo en acero inoxidable opcional
Opcional stainless steel bumper tube

JUEGO LAT. PANORAMICOS PANORAMIC SIDES KIT CÔTES PANORAMIQUE JEU	JUEGO LATERALES CIEGOS BLIND SIDES KIT CÔTES AVEUGLE JEU	JUEGO LATERALES VENTANA WINDOWS SIDES KIT CÔTES FENÊTRE JEU
LPD20 445 €	LCD 278 €	LVD 278 €
LPI20 445 €	LCI 278 €	LVI 278 €
LPD22 476 €		
LPI22 476 €		

Laterales NO incluidos en PVP / Sides NOT included in PVP / Latéraux NON inclus dans PVP

MODELO CON PUERTAS ALTO 2060 / MODEL WITH DOORS ALTO 2060 / MODÈLE AVEC PORTES ALTO 2060				MODELO CON PUERTAS ALTO 2210 / MODEL WITH DOORS ALTO 2210 / MODÈLE AVEC PORTES ALTO 2210			
RMG20133 12 H 3.850 €	RMG20133 18 H 5.192 €	RMG20133 25 H 6.171 €	RMG20133 37 H 8.339 €	RMG22133 12 H 4.047 €	RMG22133 18 H 5.465 €	RMG22133 25 H 6.501 €	RMG22133 37 H 8.710 €
MODELO SIN PUERTAS ALTO 2060 / MODEL WITHOUT DOORS ALTO 2060 / MODÈLE SANS PORTES ALTO 2060				MODELO SIN PUERTAS ALTO 2210 / MODEL WITHOUT DOORS ALTO 2210 / MODÈLE SANS PORTES ALTO 2210			
RMS20133 12 H 3.159 €	RMS20133 18 H 4.083 €	RMS20133 25 H 4.681 €	RMS20133 37 H 6.407 €	RMS22133 12 H 3.315 €	RMS22133 18 H 4.288 €	RMS22133 25 H 4.923 €	RMS22133 37 H 6.682 €



Iluminación led vertical de serie
Standard vertical led lighting

GAMA CLOVER FONDO 3 (891MM) M1-M2
CLOVER RANGE DEPTH 3 (891MM) · GAMMA CLOVER PROFONDEUR 3 (891MM)

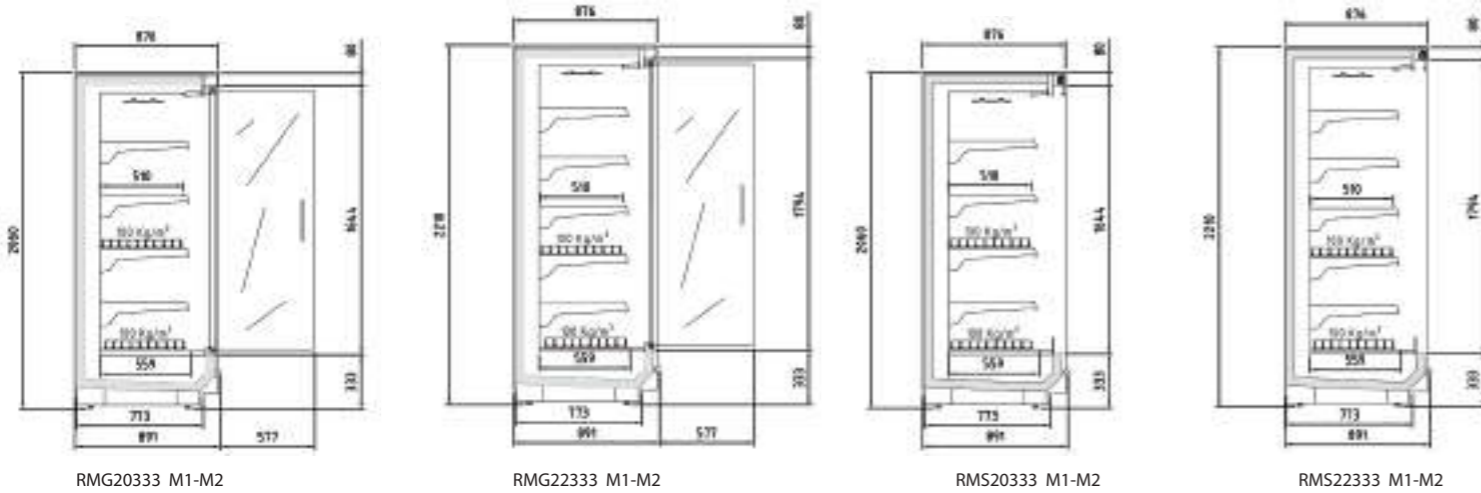

Paragolpes de tubo en acero inoxidable opcional
Optional stainless steel bumper tube

Ver características técnicas en página 148 / See technical data in page 148 / Voir caractéristiques techniques page 148

Modelo	Longitud (sin costados)	Área estantes refrigerados m2	Superficie total exposicion (TDA)	Volumen neto (L)	Estantes	Puertas
Model	Length (without sides)	Refrigerated shelf area m2	Total display area (TDA)	Net volume (L)	Shelves	Doors
Modelé	Longueur (sans côtés)	Zone d'étagères réfrigérées	Surface totale d'exposition (TDA)	Volume net (L)	Étagères	Portes
	(mm)	Fondo/ Depth 0	Fondo/ Depth 0	Fondo/ Depth 0	Uds. Units	Uds. Units
RMG20333 12 M1-M2	1250	3,25	1,74	871	4	2
RMG20333 18 M1-M2	1875	4,87	2,61	1306	8	3
RMG20333 25 M1-M2	2500	6,50	3,47	1742	8	4
RMG20333 37 M1-M2	3750	9,75	5,52	2612	12	6
RMG22333 12 M1-M2	1250	3,89	1,90	935	5	2
RMG22333 18 M1-M2	1875	5,83	2,86	1402	10	3
RMG22333 25 M1-M2	2500	7,77	3,81	1869	10	4
RMG22333 37 M1-M2	3750	11,66	6,05	2804	15	6
RMS20333 12 M1-M2	1250	3,25	1,97	871	4	-
RMS20333 18 M1-M2	1875	4,87	2,96	1306	8	-
RMS20333 25 M1-M2	2500	6,50	3,94	1742	8	-
RMS20333 37 M1-M2	3750	9,75	5,91	2612	12	-
RMS22333 12 M1-M2	1250	3,89	2,16	935	5	-
RMS22333 18 M1-M2	1875	5,83	3,24	1402	10	-
RMS22333 25 M1-M2	2500	7,77	4,32	1869	10	-
RMS22333 37 M1-M2	3750	11,66	6,48	2804	15	-

230v 60Hz / 115v 60Hz. consultar - consult - consulter

PVP de opcionales incluidos en equipo, no como repuesto / PVP of options included in the equipment, not as a spare part / PVP d'opcionales incluses dans l'équipement, pas en tant que pièce de rechange
Interior epoxy negro sin incremento de precio / Black epoxy interior without price increase / Intérieur époxy noir sans majoration de prix

OPCIONES · OPTIONS · OPTIONS

Modelo	Exterior lacado	Costado lacado Ciego / Visión (1 Ud)	Costado lacado Panorámico (1 Ud)	Kit ventiladores electronicos	Kit espejo superior	Paragolpes tubo inox (€ / m)	Tope estante metacrilato (X nivel de estante)	Iluminación LED (X nivel de estante)
Model	Lacquered exterior	Lacquered side Blind / Vision (1 Ud)	Lacquered side Panoramic (1 Ud)	Kit electronic ventilators	Top kit mirror	Stainless steel bumper (€ / m)	Methacrylate shelf stop (X nivel de estante)	LED Lighting (X level shelf)
Modèle	Extérieur laqué	Côté laqué Aveugle / Vision (1 Ud)	Côté laqué Panoramique (1 Ud)	Kit électronique ventilateurs	Top kit miroir	Pare-chocs acier inoxydable(€ / m)	Butée d'étagère méthacrylate (X nivel de estante)	Eclairage LED (X niveau d'étagère)
RMG333 12	173 €	155 €	80 €	81 €	84 €	75 €	34 €	77 €
RMG333 18	207 €	155 €	80 €	124 €	116 €	108 €	56 €	115 €
RMG333 25	303 €	155 €	80 €	164 €	165 €	137 €	66 €	148 €
RMG333 37	345 €	155 €	80 €	247 €	229 €	217 €	99 €	242 €
RMS333 12	173 €	155 €	80 €	81 €	84 €	75 €	34 €	77 €
RMS333 18	207 €	155 €	80 €	124 €	116 €	108 €	56 €	115 €
RMS333 25	303 €	155 €	80 €	164 €	165 €	137 €	66 €	148 €
RMS333 37	345 €	155 €	80 €	247 €	229 €	217 €	99 €	242 €

Características técnicas y constructivas sujetas a variación sin previo aviso. / We reserve the right to change specifications without prior notice. / Sujet technique et la conception de modifications sans préavis.



RMS20333 37

RMG
A ↑ G B → Clase Eficiencia Energética (Pag. 9)
Energy Efficiency Class (Pag. 9)

RMS
A ↑ G D → Clase Eficiencia Energética (Pag. 9)
Energy Efficiency Class (Pag. 9)

JUEGO LAT. PANORAMICOS PANORAMIC SIDES KIT CÔTES PANORAMIQUE JEU	JUEGO LATERALES CIEGOS BLIND SIDES KIT CÔTES AVEUGLE JEU	JUEGO LATERALES VENTANA WINDOWS SIDES KIT CÔTES FENÊTRE JEU
LPD20	454 €	
LPI20	454 €	
LPD22	486 €	LCD 289 €
LPI22	486 €	LCI 289 €
		LVD 289 €
		LVI 289 €

Laterales NO incluidos en PVP / Sides NOT included in PVP / Latéraux NON inclus dans PVP

MODELO CON PUERTAS ALTO 2060 / MODEL WITH DOORS ALTO 2060 / MODÈLE AVEC PORTES ALTO 2060				MODELO CON PUERTAS ALTO 2210 / MODEL WITH DOORS ALTO 2210 / MODÈLE AVEC PORTES ALTO 2210			
RMG20333 12 M 3.852 €	RMG20333 18 M 5.241 €	RMG20333 25 M 6.173 €	RMG20333 37 M 8.342 €	RMG22333 12 M 4.050 €	RMG22333 18 M 5.516 €	RMG22333 25 M 6.504 €	RMG22333 37 M 8.797 €
MODELO SIN PUERTAS ALTO 2060 / MODEL WITHOUT DOORS ALTO 2060 / MODÈLE SANS PORTES ALTO 2060				MODELO SIN PUERTAS ALTO 2210 / MODEL WITHOUT DOORS ALTO 2210 / MODÈLE SANS PORTES ALTO 2210			
RMS20333 12 M 3.241 €	RMS20333 18 M 4.191 €	RMS20333 25 M 4.808 €	RMS20333 37 M 6.524 €	RMS22333 12 M 3.374 €	RMS22333 18 M 4.367 €	RMS22333 25 M 5.015 €	RMS22333 37 M 6.812 €

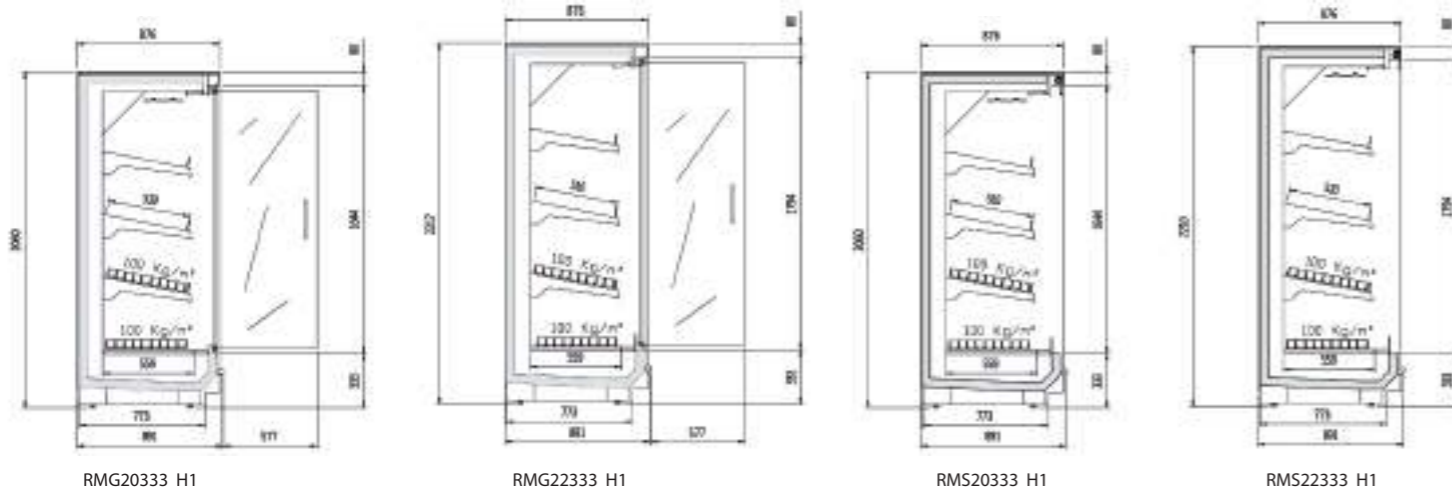

Costado ciego + espejo
Blind side + mirror

Puertas doble vidrio
Double glass doors

Iluminación led vertical de serie
Standard vertical led lighting

Decoración frontal lacado
Lacquered front decoration



RMG20333 18 H1

Paragolpes de tubo en acero inoxidable opcional
Optional stainless steel bumper tube



Clase Eficiencia Energética (Pag. 9)
Energy Efficiency Class (Pag. 9)



Clase Eficiencia Energética (Pag. 9)
Energy Efficiency Class (Pag. 9)

Ver características técnicas en página 148 / See technical data in page 148 / Voir caractéristiques techniques page 148

Modelo	Longitud (sin costados) Length (without sides)	Área estantes refrigerados m2 Refrigerated shelf area m2	Superficie total exposición (TDA) Total display area (TDA)	Volumen neto (L) Net volume (L)	Estantes Shelves	Puertas Doors
Model	Longueur (sans côtés) (mm)	Zone d'étagères réfrigérées Fondo/ Depth 0	Surface totale d'exposition (TDA) Fondo/ Depth 0	Volume net (L) Fondo/ Depth 0	Étagères Uds. Units	Portes Uds. Units
RMG20333 12 H1	1250	2,61	1,74	754	3	2
RMG20333 18 H1	1875	3,92	2,61	1131	6	3
RMG20333 25 H1	2500	5,22	3,47	1508	6	4
RMG20333 37 H1	3750	7,83	5,53	2262	9	6
RMG20333 12 H1	1250	2,61	1,74	754	3	2
RMG20333 18 H1	1875	3,92	2,61	1131	6	3
RMG20333 25 H1	2500	5,22	3,47	1508	6	4
RMG20333 37 H1	3750	7,83	5,53	2262	9	6
RMS20333 12 H1	1250	2,61	1,97	754	3	-
RMS20333 18 H1	1875	3,92	2,96	1131	6	-
RMS20333 25 H1	2500	5,22	3,95	1508	6	-
RMS20333 37 H1	3750	7,83	5,92	2262	9	-
RMS22333 12 H1	1250	2,61	2,16	850	3	-
RMS22333 18 H1	1875	3,92	3,24	1275	6	-
RMS22333 25 H1	2500	5,22	4,32	1700	6	-
RMS22333 37 H1	3750	7,83	6,48	2549	9	-

230v 60Hz / 115v 60Hz. consultar - consult - consulter

PVP de opcionales incluidos en equipo, no como repuesto / PVP of options included in the equipment, not as a spare part / PVP d'options incluses dans l'équipement, pas en tant que pièce de rechange
Interior epoxy negro sin incremento de precio / Black epoxy interior without price increase / Intérieur époxy noir sans majoration de prix

OPCIONES · OPTIONS · OPTIONS

Modelo	Exterior lacado	Costado lacado Ciego / Visión (1 Ud)	Costado lacado Panorámico (1 Ud)	Kit ventiladores electronicos	Paragolpes tubo inox (€ / m)	Iluminación LED (X nivel de estante)
Model	Lacquered exterior	Lacquered side Blind / Vision (1 Ud)	Lacquered side Panoramic (1 Ud)	Kit electronic ventilators	Stainless steel bumper (€ / m)	LED Lighting (X level shelf)
Modèle	Extérieur laqué	Côté laqué Aveugle / Vision (1 Ud)	Côté laqué Panoramique (1 Ud)	Kit électronique ventilateurs	Pare-chocs acier inoxydable(€ / m)	Eclairage LED (X niveau d'étagère)
RMG333 12	173 €	155 €	80 €	81 €	75 €	77 €
RMG333 18	207 €	155 €	80 €	124 €	108 €	115 €
RMG333 25	303 €	155 €	80 €	164 €	137 €	148 €
RMG333 37	345 €	155 €	80 €	247 €	217 €	242 €
RMS333 12	173 €	155 €	80 €	81 €	75 €	77 €
RMS333 18	207 €	155 €	80 €	124 €	108 €	115 €
RMS333 25	303 €	155 €	80 €	164 €	137 €	148 €
RMS333 37	345 €	155 €	80 €	247 €	217 €	242 €

Características técnicas y constructivas sujetas a variación sin previo aviso. / We reserve the right to change specifications without prior notice. / Sujet technique et la conception de modifications sans préavis.

Laterales NO incluidos en PVP / Sides NOT included in PVP / Latéraux NON inclus dans PVP

MODELO CON PUERTAS ALTO 2060 / MODEL WITH DOORS ALTO 2060 / MODÈLE AVEC PORTES ALTO 2060				MODELO CON PUERTAS ALTO 2210 / MODEL WITH DOORS ALTO 2210 / MODÈLE AVEC PORTES ALTO 2210			
	RMG20333 12 H 3.918 €		RMG20333 18 H 5.333 €		RMG20333 25 H 6.283 €		RMG20333 37 H 8.493 €
	RMG22333 12 H 4.085 €		RMG22333 18 H 5.613 €		RMG22333 25 H 6.621 €		RMG22333 37 H 8.877 €
MODELO SIN PUERTAS ALTO 2060 / MODEL WITHOUT DOORS ALTO 2060 / MODÈLE SANS PORTES ALTO 2060				MODELO SIN PUERTAS ALTO 2210 / MODEL WITHOUT DOORS ALTO 2210 / MODÈLE SANS PORTES ALTO 2210			
	RMS20333 12 H 3.240 €		RMS20333 18 H 4.218 €		RMS20333 25 H 4.807 €		RMS20333 37 H 6.521 €
	RMS22333 12 H 3.401 €		RMS22333 18 H 4.401 €		RMS22333 25 H 5.056 €		RMS22333 37 H 6.867 €

JUEGO LAT. PANORAMICOS PANORAMIC SIDES KIT CÔTÉS PANORAMIQUE JEU	JUEGO LATERALES CIEGOS BLIND SIDES KIT CÔTÉS AVEUGLE JEU	JUEGO LATERALES VENTANA WINDOW SIDES KIT CÔTÉS FENÊTRE JEU
LPD20 454 €	LCD 289 €	LVD 289 €
LPI20 454 €	LCI 289 €	LVI 289 €
LPD22 486 €		
LPI22 486 €		

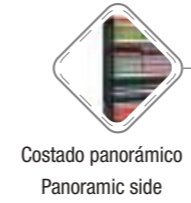
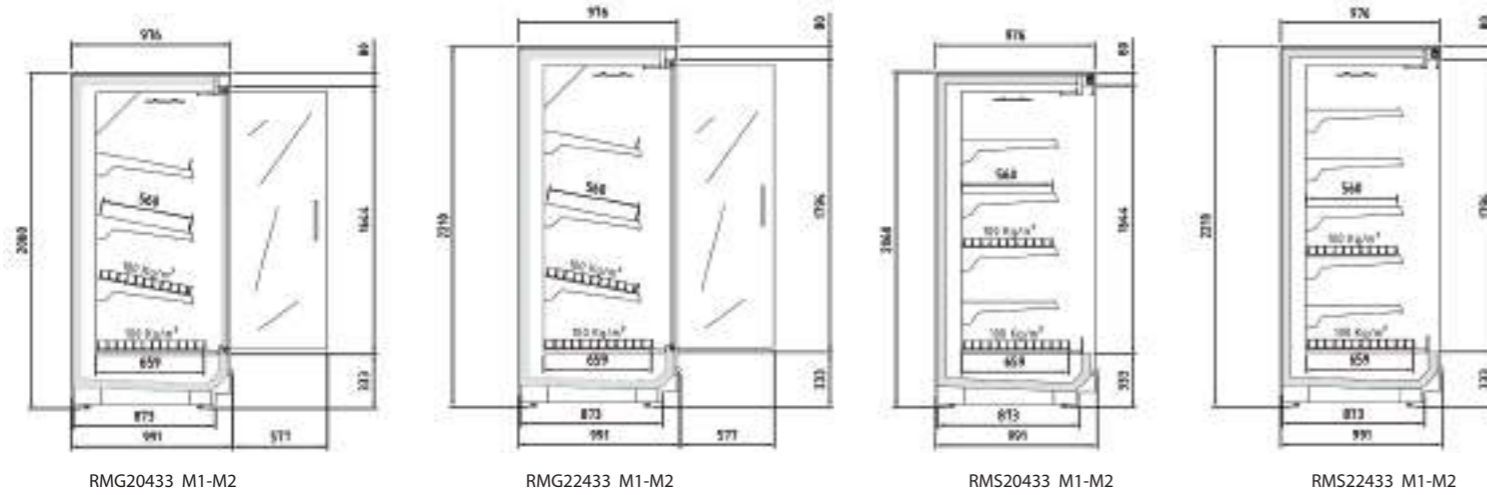

Paragolpes de tubo en acero inoxidable
Stainless steel bumper tube

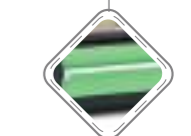

Ver características técnicas en página 148 / See technical data in page 148 / Voir caractéristiques techniques page 148

Modelo	Longitud (sin costados)	Área estantes refrigerados m2	Superficie total exposicion (TDA)	Volumen neto (L)	Estantes	Puertas
Model	Length (without sides)	Refrigerated shelf area m2	Total display area (TDA)	Net volume (L)	Shelves	Doors
Modelé	Longueur (sans côtés)	Zone d'étagères réfrigérées	Surface totale d'exposition (TDA)	Volume net (L)	Étagères	Portes
	(mm)	Fondo/ Depth 0	Fondo/ Depth 0	Fondo/ Depth 0	Uds. Units	Uds. Units
RMG20433 12 M1-M2	1250	3,62	1,79	956	4	2
RMG20433 18 M1-M2	1875	5,44	2,69	1434	8	3
RMG20433 25 M1-M2	2500	7,25	3,58	1912	8	4
RMG20433 37 M1-M2	3750	10,87	5,70	2869	12	6
RMG22433 12 M1-M2	1250	4,32	1,96	1026	5	2
RMG22433 18 M1-M2	1875	6,49	2,94	1539	10	3
RMG22433 25 M1-M2	2500	8,65	3,92	2052	10	4
RMG22433 37 M1-M2	3750	12,97	6,23	3079	15	6
RMS20433 12 M1-M2	1250	3,62	2,03	956	4	-
RMS20433 18 M1-M2	1875	5,44	3,05	1434	8	-
RMS20433 25 M1-M2	2500	7,25	4,07	1912	8	-
RMS20433 37 M1-M2	3750	10,87	6,10	2869	12	-
RMS22433 12 M1-M2	1250	4,32	2,22	1026	5	-
RMS22433 18 M1-M2	1875	6,49	3,33	1539	10	-
RMS22433 25 M1-M2	2500	8,65	4,44	2052	10	-
RMS22433 37 M1-M2	3750	12,97	6,66	3079	15	-

230v 60Hz / 115v 60Hz. consultar - consult - consulter

PVP de opcionales incluidos en equipo, no como repuesto / PVP of options included in the equipment, not as a spare part / PVP d'options incluses dans l'équipement, pas en tant que pièce de rechange
Interior epoxy negro sin incremento de precio / Black epoxy interior without price increase / Intérieur époxy noir sans majoration de prix

OPCIONES · OPTIONS · OPTIONS

Modelo	Exterior lacado	Costado lacado Ciego / Visión (1 Ud)	Costado lacado Panorámico (1 Ud)	Kit ventiladores electronicos	Kit espejo superior	Paragolpes tubo inox (€ / m)	Tope estante metacrilato (X nivel de estante)	Iluminación LED (X nivel de estante)
Model	Lacquered exterior	Lacquered side Blind / Vision (1 Ud)	Lacquered side Panoramic (1 Ud)	Kit electronic ventilators	Top kit mirror	Stainless steel bumper (€ / m)	Methacrylate shelf stop (X nivel de estante)	LED Lighting (X level shelf)
Modèle	Extérieur laqué	Côté laqué Aveugle / Vision (1 Ud)	Côté laqué Panoramique (1 Ud)	Kit électronique ventilateurs	Top kit miroir	Pare-chocs acier inoxydable(€ / m)	Butéé d'étagère méthacrylate (X nivel de estante)	Eclairage LED (X niveau d'étagère)
RMG433 12	173 €	155 €	80 €	81 €	84 €	75 €	34 €	77 €
RMG433 18	207 €	155 €	80 €	124 €	116 €	108 €	56 €	115 €
RMG433 25	303 €	155 €	80 €	164 €	165 €	137 €	66 €	148 €
RMG433 37	345 €	155 €	80 €	247 €	229 €	217 €	99 €	242 €
RMS433 12	173 €	155 €	80 €	81 €	84 €	75 €	34 €	77 €
RMS433 18	207 €	155 €	80 €	124 €	116 €	108 €	56 €	115 €
RMS433 25	303 €	155 €	80 €	164 €	165 €	137 €	66 €	148 €
RMS433 37	345 €	155 €	80 €	247 €	229 €	217 €	99 €	242 €

Características técnicas y constructivas sujetas a variación sin previo aviso. / We reserve the right to change specifications without prior notice. / Sujet technique et la conception de modifications sans préavis.



RMG
A ↑ G
B →
Clase Eficiencia Energética (Pag. 9)
Energy Efficiency Class (Pag. 9)

RMS
A ↑ G
D →
Clase Eficiencia Energética (Pag. 9)
Energy Efficiency Class (Pag. 9)

JUEGO LATERALES CIEGOS
BLIND SIDES KIT
CÔTÉS AVEUGLE JEUX

JUEGO LATERALES VENTANA
WINDOWS SIDES KIT
CÔTÉS FENÊTRE JEUX

LCD 299 € LVD 299 €
LCI 299 € LVI 299 €

Laterales NO incluidos en PVP / Sides NOT included in PVP / Latéraux NON inclus dans PVP

MODELO CON PUERTAS ALTO 2060 / MODEL WITH DOORS ALTO 2060 / MODÈLE AVEC PORTES ALTO 2060				MODELO CON PUERTAS ALTO 2210 / MODEL WITH DOORS ALTO 2210 / MODÈLE AVEC PORTES ALTO 2210											
RMG20433 12 M	3.983 €	RMG20433 18 M	5.424 €	RMG20433 25 M	6.393 €	RMG20433 37 M	8.645 €	RMG22433 12 M	4.189 €	RMG22433 18 M	5.685 €	RMG22433 25 M	6.738 €	RMG22433 37 M	9.118 €
MODELO SIN PUERTAS ALTO 2060 / MODEL WITHOUT DOORS ALTO 2060 / MODÈLE SANS PORTES ALTO 2060				MODELO SIN PUERTAS ALTO 2210 / MODEL WITHOUT DOORS ALTO 2210 / MODÈLE SANS PORTES ALTO 2210											
RMS20433 12 M	3.416 €	RMS20433 18 M	4.345 €	RMS20433 25 M	5.048 €	RMS20433 37 M	6.855 €	RMS22433 12 M	3.574 €	RMS22433 18 M	4.549 €	RMS22433 25 M	5.291 €	RMS22433 37 M	7.191 €

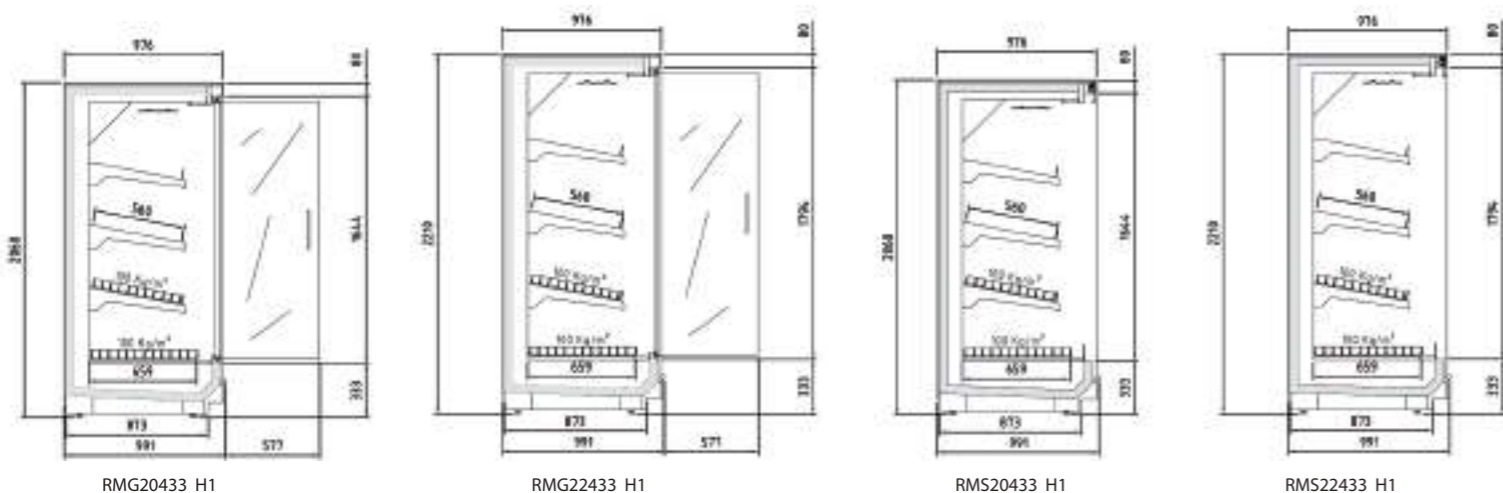

Ver características técnicas en página 148 / See technical data in page 148 / Voir caractéristiques techniques page 148

Modelo	Longitud (sin costados)	Área estantes refrigerados m2	Superficie total exposicion (TDA)	Volumen neto (L)	Estantes	Puertas
Model	Length (without sides)	Refrigerated shelf area m2	Total display area (TDA)	Net volume (L)	Shelves	Doors
Modelé	Longueur (sans côtés)	Zone d'étagères réfrigérées	Surface totale d'exposition (TDA)	Volume net (L)	Étagères	Portes
	(mm)	Fondo/ Depth 0	Fondo/ Depth 0	Fondo/ Depth 0	Uds. Units	Uds. Units
RMG20433 12 H1	1250	2,92	1,79	828	3	2
RMG20433 18 H1	1875	4,39	2,69	1242	6	3
RMG20433 25 H1	2500	5,85	3,59	1656	6	4
RMG20433 37 H1	3750	8,77	5,71	2484	9	6
RMG20433 12 H1	1250	2,92	1,96	933	3	2
RMG20433 18 H1	1875	4,39	2,95	1400	6	3
RMG20433 25 H1	2500	5,85	3,92	1866	6	4
RMG20433 37 H1	3750	8,77	6,24	2799	9	6
RMS20433 12 H1	1250	2,92	2,04	828	3	-
RMS20433 18 H1	1875	4,39	3,06	1242	6	-
RMS20433 25 H1	2500	5,85	4,07	1656	6	-
RMS20433 37 H1	3750	8,77	6,11	2484	9	-
RMS22433 12 H1	1250	2,92	2,22	933	3	-
RMS22433 18 H1	1875	4,39	3,34	1400	6	-
RMS22433 25 H1	2500	5,85	4,45	1866	6	-
RMS22433 37 H1	3750	8,77	6,67	2799	9	-

230v 60Hz / 115v 60Hz. consultar - consult - consulter

PVP de opcionales incluidos en equipo, no como repuesto / PVP of options included in the equipment, not as a spare part / PVP d'options incluses dans l'équipement, pas en tant que pièce de rechange
Interior epoxy negro sin incremento de precio / Black epoxy interior without price increase / Intérieur époxy noir sans majoration de prix

OPCIONES · OPTIONS · OPTIONS

Modelo	Exterior lacado	Costado lacado Ciego / Visión (1 Ud)	Costado lacado Panorámico (1 Ud)	Kit ventiladores electronicos	Paragolpes tubo inox (€ /m)	Iluminación LED (X nivel de estante)
Model	Lacquered exterior	Lacquered side Blind / Vision (1 Ud)	Lacquered side Panoramic (1 Ud)	Kit electronic ventilators	Stainless steel bumper (€ /m)	LED Lighting (X level shelf)
Modèle	Extérieur laqué	Côté laqué Aveugle / Vision (1 Ud)	Côté laqué Panoramique (1 Ud)	Kit électronique ventilateurs	Pare-chocs acier inoxydable(€ /m)	Eclairage LED (X niveau d'étagère)
RMG433 12	173 €	155 €	80 €	81 €	75 €	77 €
RMG433 18	207 €	155 €	80 €	124 €	108 €	115 €
RMG433 25	303 €	155 €	80 €	164 €	137 €	148 €
RMG433 37	345 €	155 €	80 €	247 €	217 €	242 €
RMS433 12	173 €	155 €	80 €	81 €	75 €	77 €
RMS433 18	207 €	155 €	80 €	124 €	108 €	115 €
RMS433 25	303 €	155 €	80 €	164 €	137 €	148 €
RMS433 37	345 €	155 €	80 €	247 €	217 €	242 €

Características técnicas y constructivas sujetas a variación sin previo aviso. / We reserve the right to change specifications without prior notice. / Sujet technique et la conception de modifications sans préavis.

RMG20433 18 H1

Paragolpes de tubo en acero inoxidable opcional
Optional stainless steel bumper tube

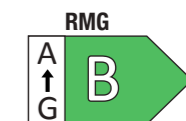

Clase Eficiencia Energética (Pag. 9)
Energy Efficiency Class (Pag. 9)

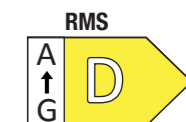

Clase Eficiencia Energética (Pag. 9)
Energy Efficiency Class (Pag. 9)

JUEGO LATERALES CIEGOS BLIND SIDES KIT CÔTÉS AVEUGLE JEJ	JUEGO LATERALES VENTANA WINDOWS SIDES KIT CÔTÉS FENÊTRE JEJ
LCD 299 €	LVD 299 €
LCI 299 €	LVI 299 €

Laterales NO incluidos en PVP / Sides NOT included in PVP / Latéraux NON inclus dans PVP

MODELO CON PUERTAS ALTO 2060 / MODEL WITH DOORS ALTO 2060 / MODÈLE AVEC PORTES ALTO 2060				MODELO CON PUERTAS ALTO 2210 / MODEL WITH DOORS ALTO 2210 / MODÈLE AVEC PORTES ALTO 2210			
RMG20433 12 H 4.034 €	RMG20433 18 H 5.495 €	RMG20433 25 H 6.508 €	RMG20433 37 H 8.802 €	RMG22433 12 H 4.206 €	RMG22433 18 H 5.760 €	RMG22433 25 H 6.859 €	RMG22433 37 H 9.245 €
MODELO SIN PUERTAS ALTO 2060 / MODEL WITHOUT DOORS ALTO 2060 / MODÈLE SANS PORTES ALTO 2060				MODELO SIN PUERTAS ALTO 2210 / MODEL WITHOUT DOORS ALTO 2210 / MODÈLE SANS PORTES ALTO 2210			
RMS20433 12 H 3.446 €	RMS20433 18 H 4.397 €	RMS20433 25 H 5.094 €	RMS20433 37 H 6.918 €	RMS22433 12 H 3.619 €	RMS22433 18 H 4.606 €	RMS22433 25 H 5.360 €	RMS22433 37 H 7.287 €

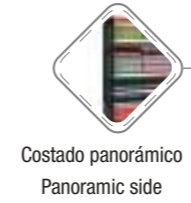
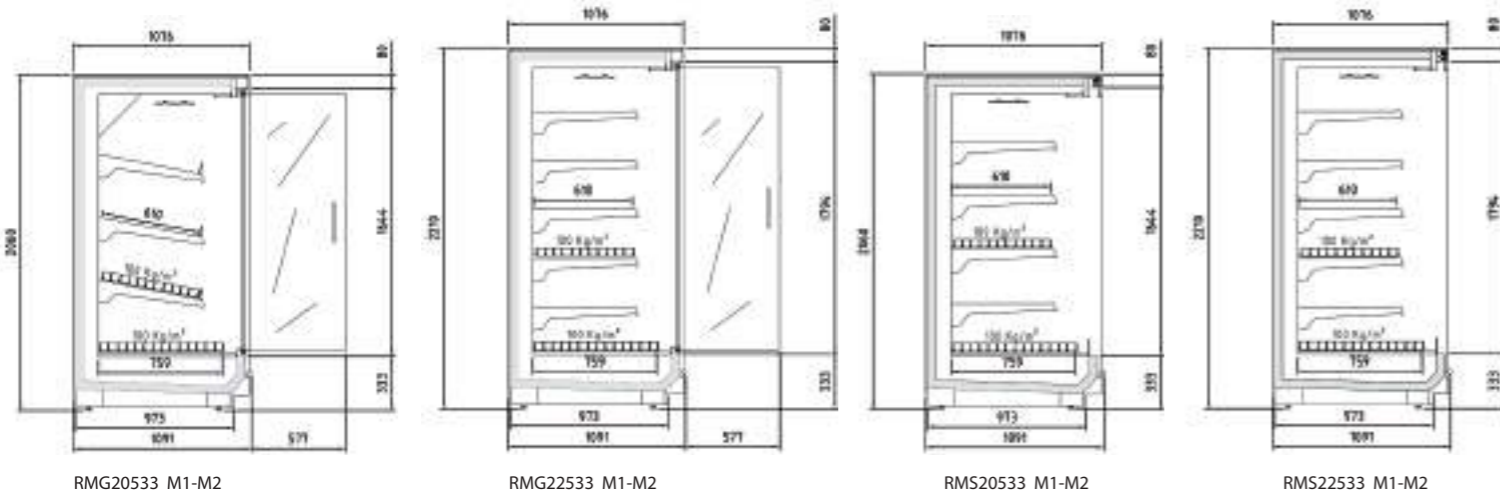

Ver características técnicas en página 148 / See technical data in page 148 / Voir caractéristiques techniques page 148

Modelo	Longitud (sin costados)	Área estantes refrigerados m2	Superficie total exposicion (TDA)	Volumen neto (L)	Estantes	Puertas
Model	Length (without sides)	Refrigerated shelf area m2	Total display area (TDA)	Net volume (L)	Shelves	Doors
Modelé	Longueur (sans côtés)	Zone d'étagères réfrigérées	Surface totale d'exposition (TDA)	Volume net (L)	Étagères	Portes
	(mm)	Fondo/ Depth 0	Fondo/ Depth 0	Fondo/ Depth 0	Uds. Units	Uds. Units
RMG20533 12 M1-M2	1250	4,00	1,85	1042	4	2
RMG20533 18 M1-M2	1875	6,00	2,77	1562	8	3
RMG20533 25 M1-M2	2500	8,00	3,70	2083	8	4
RMG20533 37 M1-M2	3750	12,00	5,88	3125	12	6
RMG22533 12 M1-M2	1250	4,76	2,02	1118	5	2
RMG22533 18 M1-M2	1875	7,14	3,03	1677	10	3
RMG22533 25 M1-M2	2500	9,52	4,03	2236	10	4
RMG22533 37 M1-M2	3750	14,28	6,41	3353	15	6
RMS20533 12 M1-M2	1250	4,00	2,10	1042	4	-
RMS20533 18 M1-M2	1875	6,00	3,14	1562	8	-
RMS20533 25 M1-M2	2500	8,00	4,19	2083	8	-
RMS20533 37 M1-M2	3750	12,00	6,29	3125	12	-
RMS22533 12 M1-M2	1250	4,76	2,28	1026	5	-
RMS22533 18 M1-M2	1875	7,14	3,43	1539	10	-
RMS22533 25 M1-M2	2500	9,52	4,57	2052	10	-
RMS22533 37 M1-M2	3750	14,28	6,85	3079	15	-

230v 60Hz / 115v 60Hz. consultar - consult - consulter

PVP de opcionales incluidos en equipo, no como repuesto / PVP of options included in the equipment, not as a spare part / PVP d'options incluses dans l'équipement, pas en tant que pièce de rechange
Interior epoxy negro sin incremento de precio / Black epoxy interior without price increase / Intérieur époxy noir sans majoration de prix

OPCIONES · OPTIONS · OPTIONS

Modelo	Exterior lacado	Costado lacado Ciego / Visión (1 Ud)	Costado lacado Panorámico (1 Ud)	Kit ventiladores electronicos	Kit espejo superior	Paragolpes tubo inox (€ / m)	Tope estante metacrilato (X nivel de estante)	Iluminación LED (X nivel de estante)
Model	Lacquered exterior	Lacquered side Blind / Vision (1 Ud)	Lacquered side Panoramic (1 Ud)	Kit electronic ventilators	Top kit mirror	Stainless steel bumper (€ / m)	Methacrylate shelf stop (X nivel de estante)	LED Lighting (X level shelf)
Modèle	Extérieur laqué	Côté laqué Aveugle / Vision (1 Ud)	Côté laqué Panoramique (1 Ud)	Kit électronique ventilateurs	Top kit miroir	Pare-chocs acier inoxydable(€ / m)	Butée d'étagère méthacrylate (X nivel de estante)	Eclairage LED (X niveau d'étagère)
RMG533 12	173 €	155 €	80 €	81 €	84 €	75 €	34 €	77 €
RMG533 18	207 €	155 €	80 €	124 €	116 €	108 €	56 €	115 €
RMG533 25	303 €	155 €	80 €	164 €	165 €	137 €	66 €	148 €
RMG533 37	345 €	155 €	80 €	247 €	229 €	217 €	99 €	242 €
RMS533 12	173 €	155 €	80 €	81 €	84 €	75 €	34 €	77 €
RMS533 18	207 €	155 €	80 €	124 €	116 €	108 €	56 €	115 €
RMS533 25	303 €	155 €	80 €	164 €	165 €	137 €	66 €	148 €
RMS533 37	345 €	155 €	80 €	247 €	229 €	217 €	99 €	242 €

Características técnicas y constructivas sujetas a variación sin previo aviso. / We reserve the right to change specifications without prior notice. / Sujet technique et la conception de modifications sans préavis.

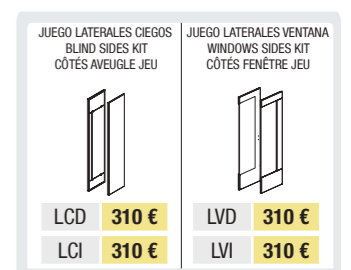
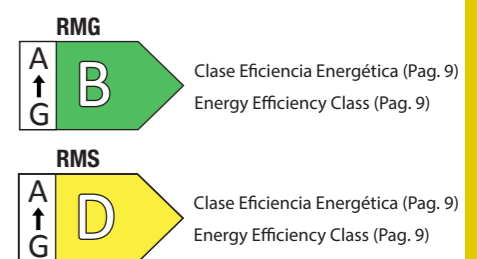

Laterales NO incluidos en PVP / Sides NOT included in PVP / Latéraux NON inclus dans PVP

MODELO CON PUERTAS ALTO 2060 / MODEL WITH DOORS ALTO 2060 / MODÈLE AVEC PORTES ALTO 2060				MODELO CON PUERTAS ALTO 2210 / MODEL WITH DOORS ALTO 2210 / MODÈLE AVEC PORTES ALTO 2210			
RMG20533 12 M 4.115 €	RMG20533 18 M 5.607 €	RMG20533 25 M 6.614 €	RMG20533 37 M 8.948 €	RMG22533 12 M 4.328 €	RMG22533 18 M 5.855 €	RMG22533 25 M 6.972 €	RMG22533 37 M 9.439 €
MODELO SIN PUERTAS ALTO 2060 / MODEL WITHOUT DOORS ALTO 2060 / MODÈLE SANS PORTES ALTO 2060				MODELO SIN PUERTAS ALTO 2210 / MODEL WITHOUT DOORS ALTO 2210 / MODÈLE SANS PORTES ALTO 2210			
RMS20533 12 M 3.592 €	RMS20533 18 M 4.499 €	RMS20533 25 M 5.288 €	RMS20533 37 M 7.186 €	RMS22533 12 M 3.773 €	RMS22533 18 M 4.730 €	RMS22533 25 M 5.566 €	RMS22533 37 M 7.571 €

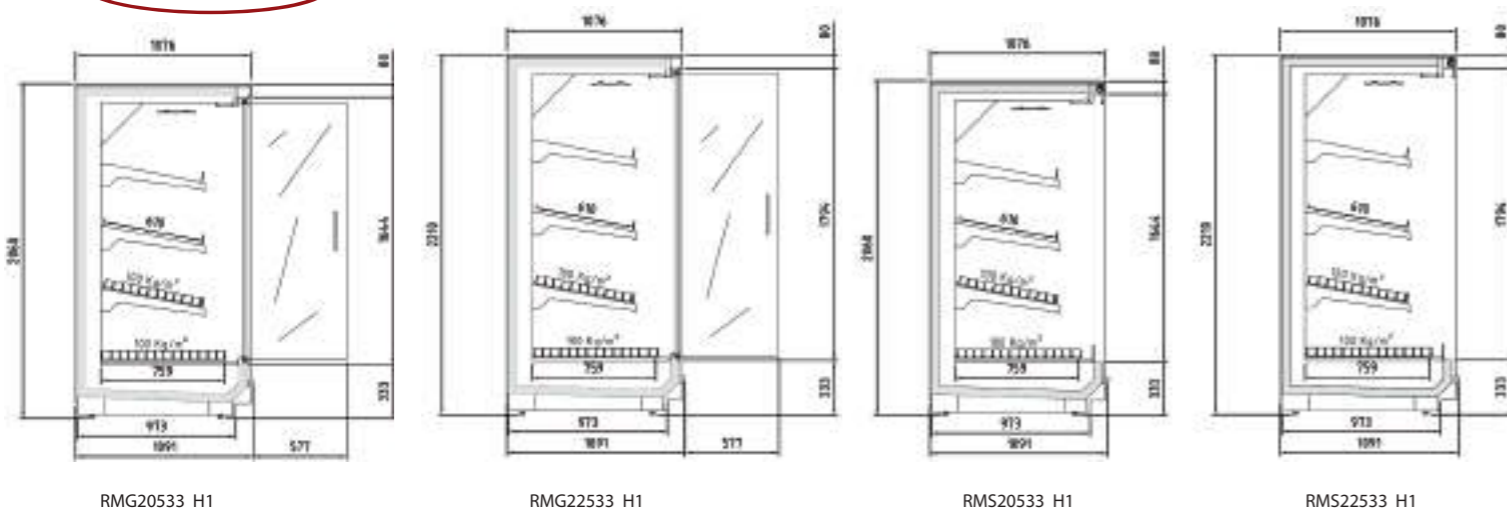

Costado ciego + espejo
Blind side + mirror

Puertas doble vidrio
Double glass doors

Iluminación led vertical de serie
Standard vertical led lighting

Decoración frontal lacado
Lacquered front decoration



Ver características técnicas en página 148 / See technical data in page 148 / Voir caractéristiques techniques page 148

Modelo	Longitud (sin costados)	Área estantes refrigerados m2	Superficie total exposicion (TDA)	Volumen neto (L)	Estantes	Puertas
Model	Length (without sides)	Refrigerated shelf area m2	Total display area (TDA)	Net volume (L)	Shelves	Doors
Modelé	Longueur (sans côtés)	Zone d'étagères réfrigérées	Surface totale d'exposition (TDA)	Volume net (L)	Étagères	Portes
	(mm)	Fondo/ Depth 0	Fondo/ Depth 0	Fondo/ Depth 0	Uds. Units	Uds. Units
RMG20533 12 H1	1250	3,24	1,85	902	3	2
RMG20533 18 H1	1875	4,85	2,78	1353	6	3
RMG20533 25 H1	2500	6,47	3,70	1804	6	4
RMG20533 37 H1	3750	9,71	5,89	2706	9	6
RMG20533 12 H1	1250	3,24	2,02	1016	3	2
RMG20533 18 H1	1875	4,85	3,03	1525	6	3
RMG20533 25 H1	2500	6,47	4,04	2033	6	4
RMG20533 37 H1	3750	9,71	6,42	3049	9	6
RMS20533 12 H1	1250	3,24	2,10	902	3	-
RMS20533 18 H1	1875	4,85	3,15	1353	6	-
RMS20533 25 H1	2500	6,47	4,20	1804	6	-
RMS20533 37 H1	3750	9,71	6,30	2706	9	-
RMS22533 12 H1	1250	3,24	2,29	1016	3	-
RMS22533 18 H1	1875	4,85	3,43	1525	6	-
RMS22533 25 H1	2500	6,47	4,58	2033	6	-
RMS22533 37 H1	3750	9,71	6,86	3049	9	-

230v 60Hz / 115v 60Hz. consultar - consult - consulter

PVP de opcionales incluidos en equipo, no como repuesto / PVP of options included in the equipment, not as a spare part / PVP d'options incluses dans l'équipement, pas en tant que pièce de rechange
Interior epoxy negro sin incremento de precio / Black epoxy interior without price increase / Intérieur époxy noir sans majoration de prix

OPCIONES · OPTIONS · OPTIONS

Modelo	Exterior lacado	Costado lacado Ciego / Visión (1 Ud)	Costado lacado Panorámico (1 Ud)	Kit ventiladores electronicos	Paragolpes tubo inox (€ /m)	Iluminación LED (X nivel de estante)
Model	Lacquered exterior	Lacquered side Blind / Vision (1 Ud)	Lacquered side Panoramic (1 Ud)	Kit electronic ventilators	Stainless steel bumper (€ /m)	LED Lighting (X level shelf)
Modèle	Extérieur laqué	Côté laqué Aveugle / Vision (1 Ud)	Côté laqué Panoramique (1 Ud)	Kit électronique ventilateurs	Pare-chocs acier inoxydable(€ /m)	Eclairage LED (X niveau d'étagère)
RMG533 12	173 €	155 €	80 €	81 €	75 €	77 €
RMG533 18	207 €	155 €	80 €	124 €	108 €	115 €
RMG533 25	303 €	155 €	80 €	164 €	137 €	148 €
RMG533 37	345 €	155 €	80 €	247 €	217 €	242 €
RMS533 12	173 €	155 €	80 €	81 €	75 €	77 €
RMS533 18	207 €	155 €	80 €	124 €	108 €	115 €
RMS533 25	303 €	155 €	80 €	164 €	137 €	148 €
RMS533 37	345 €	155 €	80 €	247 €	217 €	242 €

Características técnicas y constructivas sujetas a variación sin previo aviso. / We reserve the right to change specifications without prior notice. / Sujet technique et la conception de modifications sans préavis.

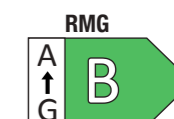

Clase Eficiencia Energética (Pag. 9)
Energy Efficiency Class (Pag. 9)

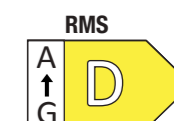

Clase Eficiencia Energética (Pag. 9)
Energy Efficiency Class (Pag. 9)

Paragolpes de tubo en acero inoxidable opcional
Optional stainless steel bumper tube

RMG20533 18 H1

JUEGO LATERALES CIEGOS BLIND SIDES KIT CÔTÉS AVEUGLE JEU	JUEGO LATERALES VENTANA WINDOWS SIDES KIT CÔTÉS FENÊTRE JEU
LCD 278 €	LVD 278 €
LCI 278 €	LVI 278 €

Laterales NO incluidos en PVP / Sides NOT included in PVP / Latéraux NON inclus dans PVP

MODELO CON PUERTAS ALTO 2060 / MODEL WITH DOORS ALTO 2060 / MODÈLE AVEC PORTES ALTO 2060				MODELO CON PUERTAS ALTO 2210 / MODEL WITH DOORS ALTO 2210 / MODÈLE AVEC PORTES ALTO 2210			
RMG20533 12 H 4.150 €	RMG20533 18 H 5.657 €	RMG20533 25 H 6.733 €	RMG20533 37 H 9.111 €	RMG22533 12 H 4.328 €	RMG22533 18 H 5.907 €	RMG22533 25 H 7.098 €	RMG22533 37 H 9.612 €
MODELO SIN PUERTAS ALTO 2060 / MODEL WITHOUT DOORS ALTO 2060 / MODÈLE SANS PORTES ALTO 2060				MODELO SIN PUERTAS ALTO 2210 / MODEL WITHOUT DOORS ALTO 2210 / MODÈLE SANS PORTES ALTO 2210			
RMS20533 12 H 3.652 €	RMS20533 18 H 4.576 €	RMS20533 25 H 5.381 €	RMS20533 37 H 7.314 €	RMS22533 12 H 3.837 €	RMS22533 18 H 4.811 €	RMS22533 25 H 5.664 €	RMS22533 37 H 7.707 €

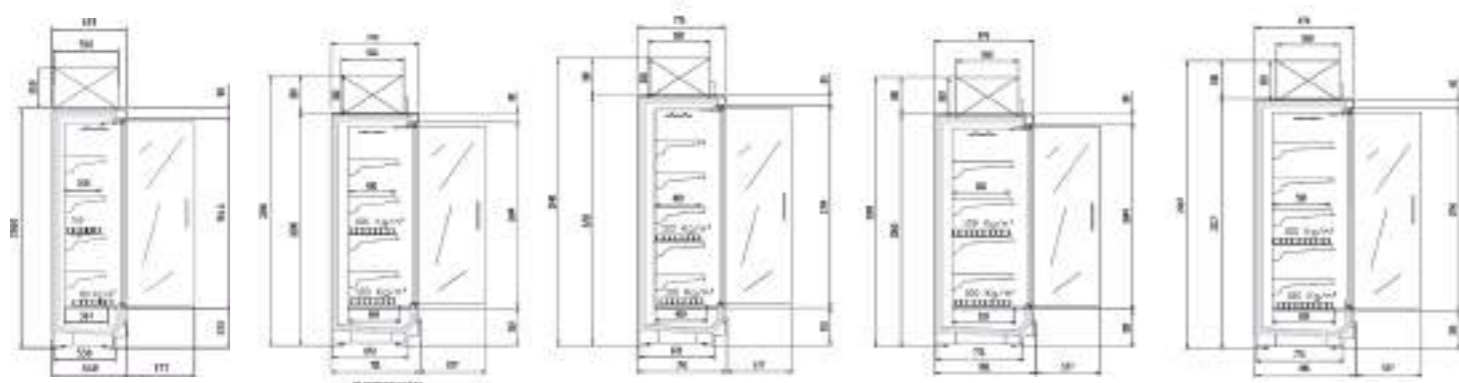

PMG20033 M1-M2 PMG20133 M1-M2 PMG22133 M1-M2 PMG20333 M1-M2 PMG22333 M1-M2



Ver características técnicas en página 148 / See technical data in page 148 / Voir caractéristiques techniques page 148

Modelo	Longitud (sin costados)	Área estantes refrigerados m2	Superficie total exposición (TDA)	Volumen neto (L)	Estantes	Puertas
Model	Length (without sides)	Refrigerated shelf area m2	Total display area (TDA)	Net volume (L)	Shelves	Doors
Modelé	Longueur (sans côtés)	Zone d'étagères réfrigérées	Surface totale d'exposition (TDA)	Volume net (L)	Étagères	Portes
	(mm)	Fondo/ Depth 0	Fondo/ Depth 0	Fondo/ Depth 0	Uds. Units	Uds. Units
PMG20033 12 M1-M2	1250	1,99	1,76	553	4	2
PMG20033 18 M1-M2	1875	2,99	2,64	830	8	3
PMG20033 25 M1-M2	2500	3,99	3,52	1106	8	4
PMG20033 37 M1-M2	3750	5,98	5,60	1659	12	6
PMG20133 12 M1-M2	1250	2,62	1,76	700	4	2
PMG20133 18 M1-M2	1875	3,94	2,64	1050	8	3
PMG20133 25 M1-M2	2500	5,25	3,52	1400	8	4
PMG20133 37 M1-M2	3750	7,87	5,60	2100	12	6
PMG22133 12 M1-M2	1250	2,11	1,90	683	5	2
PMG22133 18 M1-M2	1875	3,17	2,86	1025	10	3
PMG22133 25 M1-M2	2500	4,22	3,81	1366	10	4
PMG22133 37 M1-M2	3750	6,33	6,05	2049	15	6
PMG20333 12 M1-M2	1250	3,25	1,74	871	4	2
PMG20333 18 M1-M2	1875	4,87	2,61	1306	8	3
PMG20333 25 M1-M2	2500	6,50	3,47	1742	8	4
PMG20333 37 M1-M2	3750	9,75	5,52	2612	12	6
PMG22333 12 M1-M2	1250	3,89	1,90	935	5	2
PMG22333 18 M1-M2	1875	5,83	2,86	1402	10	3
PMG22333 25 M1-M2	2500	7,77	3,81	1869	10	4
PMG22333 37 M1-M2	3750	11,66	6,05	2804	15	6

Unidad condensadora R-290 incluida en precio / Condensing unit R-290 included in price / Groupe de condensation R-290 inclus dans le prix
 PVP de opcionales incluidos en equipo, no como repuesto / PVP of options included in the equipment, not as a spare part / PVP d'options incluses dans l'équipement, pas en tant que pièce de rechange
 Interior epoxy negro sin incremento de precio / Black epoxy interior without price increase / Intérieur époxy noir sans majoration de prix

OPCIONES · OPTIONS · OPTIONS							
Modelo	Exterior lacado	Costado lacado Ciego / Visión (1 Ud)	Costado lacado Panorámico (1 Ud)	Kit ventiladores electronicos	Kit espejo superior	Paragolpes tubo inox (€ /m)	Iluminación LED (X nivel de estante)
Model	Lacquered exterior	Lacquered side Blind / Vision (1 Ud)	Lacquered side Panoramic (1 Ud)	Kit electronic ventilators	Top kit mirror	Stainless steel bumper (€ /m)	LED Lighting (X level shelf)
Modelé	Extérieur laqué	Côté laqué Aveugle / Vision (1 Ud)	Côté laqué Panoramique (1 Ud)	Kit électronique ventilateurs	Top kit miroir	Pare-chocs acier inoxydable(€ /m)	Eclairage LED (X niveau d'étagère)
PMG133 12	173 €	155 €	80 €	81 €	84 €	75 €	77 €
PMG133 18	207 €	155 €	80 €	124 €	116 €	108 €	115 €
PMG133 25	303 €	155 €	80 €	164 €	165 €	137 €	148 €
PMG133 37	345 €	155 €	80 €	247 €	229 €	217 €	242 €

Características técnicas y constructivas sujetas a variación sin previo aviso. / We reserve the right to change specifications without prior notice. / Sujet technique et la conception de modifications sans préavis.



Costado ventana Window side

PMG22333 37

Paragolpes de tubo en acero inoxidable opcional
Optional stainless steel bumper tube



Puertas doble vidrio transparente
Transparent double glass door

Clase Eficiencia Energética (Pag. 9)
Energy Efficiency Class (Pag. 9)

Laterales NO incluidos en PVP / Sides NOT included in PVP / Latéraux NON inclus dans PVP

MODELO CON PUERTAS ALTO 2060 / MODEL WITH DOORS ALTO 2060 / MODÈLE AVEC PORTES ALTO 2060				MODELO CON PUERTAS ALTO 2210 / MODEL WITH DOORS ALTO 2210 / MODÈLE AVEC PORTES ALTO 2210			
PMG20033 12 M	3.966 €	PMG20033 18 M	5.138 €	PMG20033 25 M	6.181 €	PMG20033 37 M	8.974 €
PMG20033 12 H	3.926 €	PMG20033 18 H	5.234 €	PMG20033 25 H	6.298 €	PMG20033 37 H	9.145 €
PMG20133 12 M	3.891 €	PMG20133 18 M	5.138 €	PMG20133 25 M	6.362 €	PMG20133 37 M	9.238 €
PMG20133 12 H	3.964 €	PMG20133 18 H	5.234 €	PMG20133 25 H	6.360 €	PMG20133 37 H	9.278 €
PMG20333 12 M	3.966 €	PMG20333 18 M	5.236 €	PMG20333 25 M	6.362 €	PMG20333 37 M	9.282 €
PMG20333 12 H	4.041 €	PMG20333 18 H	5.335 €	PMG20333 25 H	6.483 €	PMG20333 37 H	9.460 €
PMG22133 12 M	4.084 €	PMG22133 18 M	5.485 €	PMG22133 25 M	6.686 €	PMG22133 37 M	9.542 €
PMG22133 12 H	4.162 €	PMG22133 18 H	5.580 €	PMG22133 25 H	6.801 €	PMG22133 37 H	9.615 €
PMG22333 12 M	4.191 €	PMG22333 18 M	5.532 €	PMG22333 25 M	6.725 €	PMG22333 37 M	9.815 €
PMG22333 12 H	4.231 €	PMG22333 18 H	5.636 €	PMG22333 25 H	6.853 €	PMG22333 37 H	10.003 €

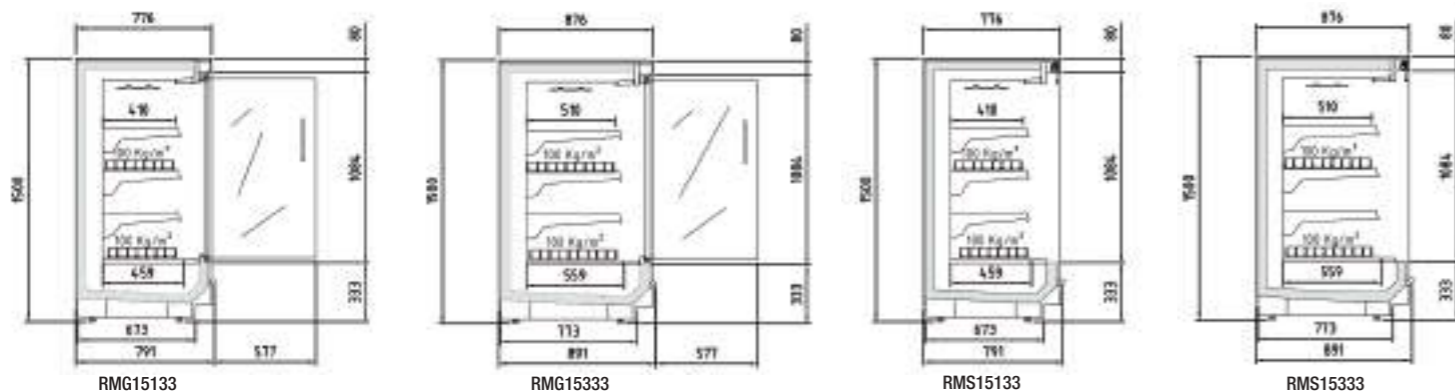

Costado ventana
Window side



CARACTERÍSTICAS TÉCNICAS	TECHNICAL DATA	CARACTÉRISTIQUES TECHNIQUES
<ul style="list-style-type: none"> Mueble vertical de altura reducida para adaptarse a las características interiores del recinto, para conectar a unidad motocondensadora o central frigorífica con capacidad y visibilidad optimizada del producto Estándar interior en epoxi RAL 9003 Gran posibilidad de personalización. Estándar: base inferior en RAL 9005, franja superior e inferior en chapa a elegir de colores disponibles Evaporador ventilado HFC pintado en EPOXI con recubrimiento anticorrosión Juego de válvula solenoide y de expansión termostática R-449A / R-448A o R-134a Estantes regulables en altura y ángulo, con portaprecios de 40 mm incluidos Desescarche natural del evaporador Ventiladores electromecánicos Control electrónico Iluminación LED 24v 4000k en visera y montantes (modelos RMG) Salida de tuberías: posibilidad por parte inferior, superior o trasera Temperatura de producto, según EN-ISO-23953: <ul style="list-style-type: none"> a. M1: -1°+5°C, apropiado para carnes. b. M2: -1°+7°C, apropiado para lácteos, delis y embutidos Clase climática 3 (25°C, 60 H.R) 	<ul style="list-style-type: none"> Vertical remote cabinet of reduced height ready to adapt to the interior features of the enclosure, to connect to condensing unit or refrigeration plant with optimized capacity and visibility of the product Interior standard in RAL 9003 epoxy High customization possibilities. As standard: plinth in colour RAL 9005, inferior and superior decorative stripe choose from available colours Ventilated HFC evaporator EPOXY painted with anticorrosive coating R-449A / R-448A or R-134a solenoid and thermostatic expansion valves kit Adjustable shelves in height and angle, with 40 mm price holders included Natural defrost of evaporator Electromechanic fans Electronic control 24v LED lighting on vertical frame and superior 4000k colour (RMG Models) Pipe outlet: possibility by bottom, top or backrest Product temperature, according to EN-ISO-23953: <ul style="list-style-type: none"> a. M1: -1°+5°C, suitable for meat b. M2: -1°+7°C, suitable for dairy products, delis and sausages Climatic class 3 (25°C, 60 H.R) 	<ul style="list-style-type: none"> Unité verticale de hauteur réduite pour s'adapter aux caractéristiques intérieures de l'enceinte, à raccorder à un groupe moto-condenseur ou à une installation frigorifique avec une capacité et une visibilité du produit optimisées. Norme intérieure en epoxy RAL 9003. Grande possibilité de personnalisation. Standard : base inférieure en RAL 9005, bande supérieure et inférieure en tôle à choisir parmi les couleurs disponibles Évaporateur ventilé HFC peint en EPOXY avec revêtement anti-corrosion. Kit solénoïde R-449A / R-448A ou R-134a et détendeur thermostatique Étagères réglables en hauteur et en inclinaison, avec porte-prix de 40 mm inclus Dégivrage naturel de l'évaporateur Ventilateurs électromécaniques Contrôle électronique Éclairage LED 24v 4000k sur la visière et les montants (modèles RMG) Sortie de tuyau : possibilité par le bas, le haut ou l'arrière. Température du produit, selon EN-ISO-23953 : <ul style="list-style-type: none"> a. pour M1 : -1°+5°C, approprié pour la viande. b. M2 : -1°+7°C, approprié pour les produits laitiers, les charcuteries et les saucisses Classe climatique 3 (25°C, 60 H.R.)

Modelo	Longitud (sin costados)	Área estantes refrigerados	Superficie total exposicion	Volumen neto	Estantes	Puertas
Model	Length (without sides)	Refrigerated shelf area	Total display area	Net volume	Shelves	Doors
Modèle	Longueur (sans côtés)	Zone d'étagères réfrigérées	Surface totale d'exposition	Volume net	Étagères	Portes
	(mm)	m2	(TDA)	(L)	Uds.	Uds.
RMG15133 12	1250	2,11	1,11	525	3	2
RMG15133 18	1875	3,16	1,72	788	6	3
RMG15133 25	2500	4,22	2,29	1050	6	4
RMG15133 37	3750	6,33	3,43	1575	9	6
RMG15333 12	1250	2,61	1,14	653	3	2
RMG15333 18	1875	3,91	1,73	980	6	3
RMG15333 25	2500	5,22	2,57	1307	6	4
RMG15333 37	3750	7,83	3,43	1884	9	6
RMS15133 12	1250	2,11	1,32	525	3	-
RMS15133 18	1875	3,16	1,97	788	6	-
RMS15133 25	2500	4,22	2,63	1050	6	-
RMS15133 37	3750	6,33	3,95	1575	9	-
RMS15333 12	1250	2,61	1,32	653	3	-
RMS15333 18	1875	3,91	1,97	980	6	-
RMS15333 25	2500	5,22	2,63	1307	6	-
RMS15333 37	3750	7,83	3,95	1884	9	-

PVP de opcionales incluidos en equipo, no como repuesto / PVP of options included in the equipment, not as a spare part / PVP d'options incluses dans l'équipement, pas en tant que pièce de rechange
Interior epoxy negro sin incremento de precio / Black epoxy interior without price increase / Intérieur époxy noir sans majoration de prix

OPCIONES · OPTIONS · OPTIONS						
Modelo Model Modèle	Costado lacado ciego / ventana (1 Ud) Lacquered side blind / window (1 Ud) Côté laqué store / fenêtre (1 Ud)	Iluminación LED (X nivel de estante) LED Lighting (X level shelf) Éclairage LED (X niveau d'étagère)	Decoración exterior lacado Lacquered exterior decoration Décoration extérieure laqué	Tope estante metacrilato (X nivel de estante) Methacrylate shelf stop (X nivel de estante) Butée d'étagère méthacrylate (X nivel de estante)	Ventiladores electronicos Electronic fans Électronique ventilateurs	Paragolpes tubo inox Stainless steel bumper Pare-chocs acier inoxydable
RMG/RMS15133 12	155 €	77 €	173 €	34 €	81 €	75 €
RMG/RMS15133 18	155 €	115 €	207 €	56 €	124 €	108 €
RMG/RMS15133 25	155 €	148 €	303 €	66 €	164 €	137 €
RMG/RMS15133 37	155 €	242 €	345 €	99 €	247 €	217 €

Iluminación led vertical de serie
Standard vertical led lighting

Paragolpes de tubo en acero inoxidable (opcional)
Stainless steel bumper tube (optional)

RMG15533 25



Modelos RMG / RMG Models

Modelos RMS / RMS Models

A
↑
G **D**
Clase Eficiencia Energética (Pag. 9)
Energy Efficiency Class (Pag. 9)

A
↑
G **E**
Clase Eficiencia Energética (Pag. 9)
Energy Efficiency Class (Pag. 9)

JUEGO LAT. CIEGOS
BLIND SIDES KIT
CÔTÉS STORE JEU



RM151 268 €
RM153 279 €

JUEGO LAT. VENTANA
WINDOW SIDES KIT
CÔTÉS FENÊTRE JEU



RM151 268 €
RM153 279 €

	RMS15133 12 3.049 €		RMS15133 18 3.942 €		RMS15133 25 4.519 €		RMS15133 37 6.156 €
	RMS15333 12 3.128 €		RMS15333 18 4.044 €		RMS15333 25 4.640 €		RMS15333 37 6.296 €
	RMG15133 12 3.653 €		RMG15133 18 4.924 €		RMG15133 25 5.850 €		RMG15133 37 7.867 €
	RMG15333 12 3.717 €		RMG15333 18 5.058 €		RMG15333 25 5.957 €		RMG15333 37 8.050 €

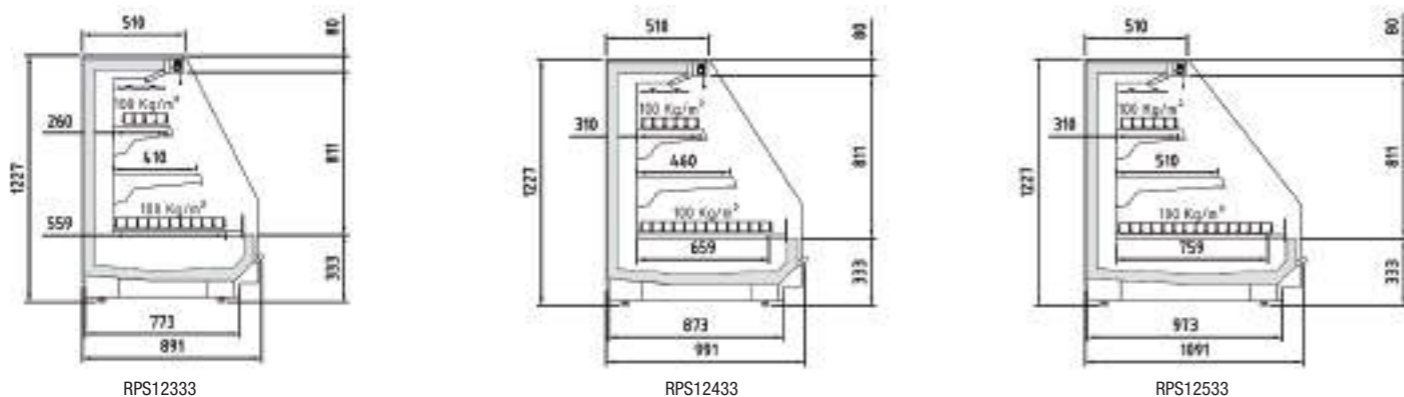

CARACTERÍSTICAS TÉCNICAS

- Mueble semivertical para conectar a unidad motocondensadora o central frigorífica con capacidad y visibilidad optimizada del producto
- Modelo RPS: Cortina de noche manual y frente inferior de metacrilato
- Estándar interior en epoxi RAL 9003
- Gran posibilidad de personalización. Estándar: base inferior en RAL 9005, franja superior e inferior en chapa a elegir de colores disponibles
- Evaporador ventilado HFC pintado en EPOXI con recubrimiento anticorrosión
- Juego de válvula solenoide y de expansión termostática R-449A / R-448A o R-134a
- Estantes regulables en altura y ángulo, con portaprecios de 40 mm incluidos
- Desescarche natural del evaporador
- Ventiladores electromecánicos
- Control electrónico
- Iluminación LED 24v 4000k en visera.
- Salida de tuberías: posibilidad por parte inferior, superior o trasera
- Temperatura de producto, según EN-ISO-23953:
 - a. M1: -1°+5°C, apropiado para carnes.
 - b. M2: -1°+7°C, apropiado para lácteos, delis y embutidos
- Clase climática 3 (25°C, 60 H.R)

TECHNICAL DATA

- Semivertical remote cabinet ready to connect to condensing unit or refrigeration plant with optimized capacity and visibility of the product
- RPS Model: Manual night blind and inferior exposition deck perspex
- Interior standard in RAL 9003 epoxy
- High customization possibilities. As standard: plinth in colour RAL 9005, inferior and superior decorative stripe choose from available colours
- Ventilated HFC evaporator EPOXY painted with anticorrosive coating
- R-449A / R-448A or R-134a solenoid and thermostatic expansion valves kit
- Adjustable shelves in height and angle, with 40 mm price holders included
- Natural defrost of evaporator
- Electromechanic fans
- Electronic control
- 24v LED lighting on superior part 4000k colour
- Pipe outlet: possibility by bottom, top or backrest
- Product temperature, according to EN-ISO-23953:
 - a. M1: -1°+5°C, suitable for meat
 - b. M2: -1°+7°C, suitable for dairy products, delis and sausages
- Climatic class 3 (25°C, 60 H.R)

CARACTÉRISTIQUES TECHNIQUES

- Groupe semi-vertical à raccorder à un groupe de condensation ou groupe frigorifique avec capacité et visibilité optimisées du produit.
- Modèle RPS : store de nuit manuel et façade inférieure en méthacrylate
- Norme intérieure en époxy RAL 9003.
- Grande possibilité de personnalisation. Standard : base inférieure en RAL 9005, bande supérieure et inférieure en tôle à choisir parmi les couleurs disponibles
- Evaporateur ventilé HFC peint en EPOXY avec revêtement anticorrosion.
- Kit solénoïde R-449A / R-448A ou R-134a et détendeur thermostatique
- Étagères réglables en hauteur et en inclinaison, avec porte-prix de 40 mm inclus
- Dégivrage naturel de l'évaporateur
- Ventilateurs électromécaniques
- Contrôle électronique
- Eclairage LED 24v 4000k sur la visière.
- Sortie de tuyau : possibilité par le bas, le haut ou l'arrière.
- Température du produit, selon EN-ISO-23953
 - a. M1 : -1°+5°C, approprié pour la viande.
 - b. M2 : -1°+7°C, approprié pour les produits laitiers, les charcuteries et les saucisses
- Classe climatique 3 (25°C, 60 H.R.)

Costado panorámico
Panoramic side



RPS12533 18



Clase Eficiencia Energética (Pag. 9)
Energy Efficiency Class (Pag. 9)

Paragolpes de tubo en acero inoxidable (opcional)
Stainless steel bumper tube (optional)



JUEGO LAT. PANORAMICOS
PANORAMIC SIDES KIT
CÔTES PANORAMIQUE JEU

RP123	394 €	RP124	415 €	RP-125	436 €
-------	-------	-------	-------	--------	-------

Modelo	Longitud costados (sin)	Área estantes refrigerados	Superficie total exposicion	Volumen neto	Estantes
Model	Length (without sides)	Refrigerated shelf area	Total display area	Net volume	Shelves
Modèle	Longueur (sans côtés)	Zone d'étagères réfrigérées	Surface totale d'exposition	Volume net	Étagères
	(mm)	m2	(TDA)	(L)	Uds.
RPS12333 12	1250	1,54	1,11	330	2
RPS12333 18	1875	2,30	1,66	494	4
RPS12333 25	2500	3,07	2,21	659	4
RPS12333 37	3750	4,61	3,32	989	6
RPS12433 12	1250	1,79	1,17	384	2
RPS12433 18	1875	2,68	1,75	576	4
RPS12433 25	2500	3,57	2,34	768	4
RPS12433 37	3750	5,36	3,51	1152	6
RPS12533 12	1250	1,97	1,23	425	2
RPS12533 18	1875	2,96	1,85	637	4
RPS12533 25	2500	3,95	2,46	849	4
RPS12533 37	3750	5,92	3,69	1274	6

PVP de opcionales incluidos en equipo, no como repuesto / PVP of options included in the equipment, not as a spare part / PVP d'options incluses dans l'équipement, pas en tant que pièce de rechange
Interior epoxy negro sin incremento de precio / Black epoxy interior without price increase / Intérieur époxy noir sans majoration de prix

OPCIONES · OPTIONS · OPTIONS

Modelo	Costado lacado / ventana	Iluminación LED	Decoración exterior lacado	Tope estante metacrilato	Ventiladores electronicos	Paragolpes tubo inox
Model	Lacquered side blind / window	LED Lighting	Lacquered exterior decoration	Methacrylate shelf stop	Electronic fans	Stainless steel bumper
Modèle	Côté laqué store / fenêtre	Eclairage LED	Décoration extérieure laqué	Butée d'étagère méthacrylate	Electronique ventilateurs	Pare-chocs acier inoxydable
	(1 Ud)	(X nivel de estante)		(X nivel de estante)		
RPS / RPG 1233 12	155 €	77 €	173 €	34 €	81 €	75 €
RPS / RPG 1233 18	155 €	115 €	207 €	56 €	124 €	108 €
RPS / RPG 1233 25	155 €	148 €	303 €	66 €	164 €	137 €
RPS / RPG 1233 37	155 €	242 €	345 €	99 €	247 €	217 €



RPS12333 12 M **2.707 €**

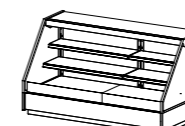

RPS12333 18 M **3.381 €**

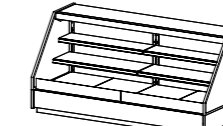

RPS12333 25 M **3.964 €**

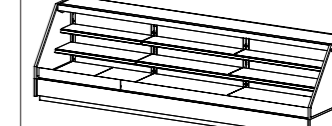

RPS12333 37 M **5.008 €**

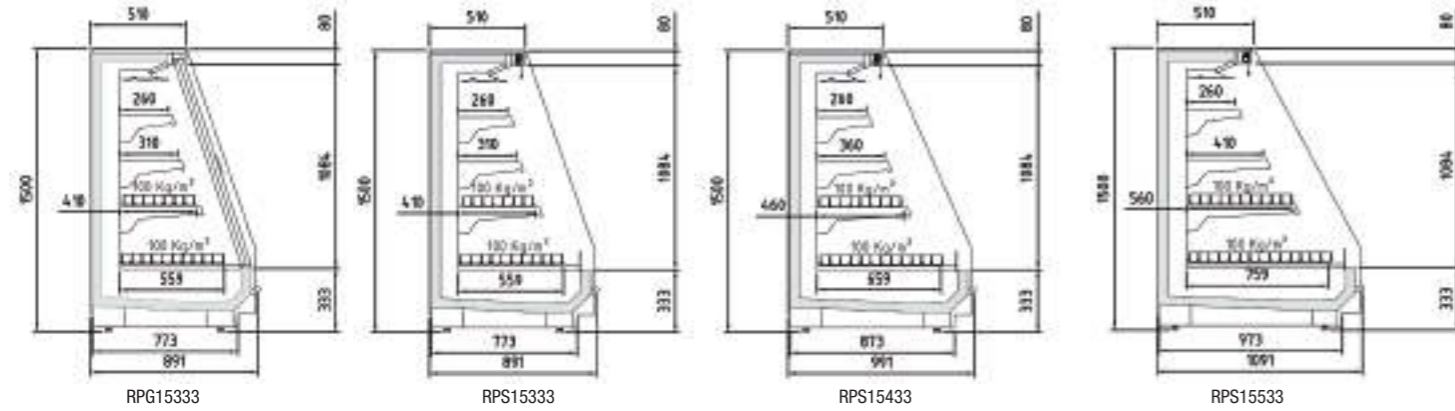

CARACTERÍSTICAS TÉCNICAS

- Mueble semivertical para conectar a unidad motocondensadora o central frigorífica con capacidad y visibilidad optimizada del producto
- Modelo RPS: Cortina de noche manual y frente cuba inferior de metacrilato
- Modelo RPG: Puertas correderas de cristal doble y perfilera de aluminio en color negro. Asegura un ahorro energético comparado con el modelo sin puertas
- Estándar interior en epoxi RAL 9003
- Gran posibilidad de personalización. Estándar: base inferior en RAL 9005, franja superior e inferior en chapa a elegir de colores disponibles
- Evaporador ventilado HFC pintado en EPOXI con recubrimiento anticorrosión
- Juego de válvula solenoide y de expansión termostática R-449A / R-448A o R-134a
- Estantes regulables en altura y ángulo, con portaprecios de 40 mm incluidos
- Desescarche natural del evaporador
- Ventiladores electromecánicos
- Control electrónico
- Iluminación LED 24v 4000k en visera.
- Salida de tuberías: posibilidad por parte inferior, superior o trasera
- Temperatura de producto, según EN-ISO-23953:
 - a. M1: -1°+5°C, apropiado para carnes.
 - b. M2: -1°+7°C, apropiado para lácteos, delis y embutidos
- Clase climática 3 (25°C, 60 H.R)

TECHNICAL DATA

- Semivertical remote cabinet ready to connect to condensing unit or refrigeration plant with optimized capacity and visibility of the product
- RPS Model: Manual night blind and and inferior exposition deck Perspex
- RPG Model: Sliding double glass doors with aluminum profiling in black colour. They ensure energy savings in comparison with equivalent open cabinet
- Interior standard in RAL 9003 epoxy
- High customization possibilities. As standard: plinth in colour RAL 9005, inferior and superior decorative stripe choose from available colours
- Ventilated HFC evaporator EPOXY painted with anticorrosive coating
- R-449A / R-448A or R-134a solenoid and thermostatic expansion valves kit
- Adjustable shelves in height and angle, with 40 mm price holders included
- Natural defrost of evaporator
- Electromechanic fans
- Electronic control
- 24v LED lighting on superior part 4000k colour
- Pipe outlet: possibility by bottom, top or backrest
- Product temperature, according to EN-ISO-23953:
 - a. M1: -1°+5°C, suitable for meat
 - b. M2: -1°+7°C, suitable for dairy products, delis and sausages
- Climatic class 3 (25°C, 60 H.R)

CARACTÉRISTIQUES TECHNIQUES

- Groupe semi-vertical à raccorder à un groupe de condensation ou groupe frigorifique avec capacité et visibilité optimisées du produit.
- Modèle RPS : store de nuit manuel et façade inférieure du réservoir en méthacrylate
- Modèle RPG : Portes coulissantes à double vitrage et profilés en aluminium noir. Assure des économies d'énergie par rapport au modèle sans portes
- Norme intérieure en époxy RAL 9003.
- Grande possibilité de personnalisation. Standard : base inférieure en RAL 9005, bande supérieure et inférieure en tôle à choisir parmi les couleurs disponibles
- Evaporateur ventilé HFC peint en EPOXY avec revêtement anticorrosion.
- Kit solénoïde R-449A / R-448A ou R-134a et détendeur thermostatique
- Étagères réglables en hauteur et en inclinaison, avec porte-prix de 40 mm inclus
- Dégivrage naturel de l'évaporateur
- Ventilateurs électromécaniques
- Contrôle électronique
- Eclairage LED 24v 4000k sur la visière.
- Sortie de tuyau : possibilité par le bas, le haut ou l'arrière.
- Température du produit, selon EN-ISO-23953 :
 - a. pour M1 : -1°+5°C, approprié pour la viande.
 - b. M2 : -1°+7°C, approprié pour les produits laitiers, les charcuteries et les saucisses
- Classe climatique 3 (25°C, 60 H.R.)

VITRINA MURAL SEMIVERTICAL REMOTA GAMA MAGNOLIA

REMOTE SEMI-VERTICAL MULTIDECK DISPLAY RANGE MAGNOLIA · VITRINE MURALE VERTICALE À DISTANCE GAMME MAGNOLIA



Costado panorámico
Panoramic side



Paragolpes de tubo en acero inoxidable (opcional)
Stainless steel bumper tube (optional)



Decoración total lacado
Total lacquered decoration



RPS15533 25

Modelo	Longitud (sin costados) Length (without sides)	Área estantes refrigerados Refrigerated shelf area	Superficie total exposicion Total display area	Volumen neto Net volume	Estantes Shelves	Puertas Doors
Model	Longueur (sans côtés)	Zone d'étagères réfrigérées	Surface totale d'exposition	Volume net	Étagères	Portes
Modelé	(mm)	m2	(TDA)	(L)	Uds.	Uds.
RPG15333 12	1250	1,92	1,44	424	3	2
RPG15333 18	1875	2,89	2,16	636	6	3
RPG15333 25	2500	3,85	2,89	848	6	4
RPG15333 37	3750	5,77	4,33	1273	9	6
RPS15333 12	1250	1,92	1,44	424	3	-
RPS15333 18	1875	2,89	2,16	636	6	-
RPS15333 25	2500	3,85	2,89	848	6	-
RPS15333 37	3750	5,77	4,33	1273	9	-
RPS15433 12	1250	2,17	1,51	480	3	-
RPS15433 18	1875	3,26	2,26	721	6	-
RPS15433 25	2500	4,35	3,01	961	6	-
RPS15433 37	3750	6,52	4,52	1441	9	-
RPS15533 12	1250	2,49	1,51	549	3	-
RPS15533 18	1875	3,73	2,26	823	6	-
RPS15533 25	2500	4,97	3,01	1097	6	-
RPS15533 37	3750	7,46	4,52	1646	9	-

PVP de opcionales incluidos en equipo, no como repuesto / PVP of options included in the equipment, not as a spare part / PVP d'options incluses dans l'équipement, pas en tant que pièce de rechange
Interior epoxy negro sin incremento de precio / Black epoxy interior without price increase / Intérieur époxy noir sans majoration de prix

OPCIONES · OPTIONS · OPTIONS

Modelo Model Modèle	Costado lacado ciego / ventana (1 Ud) Lacquered side blind / window (1 Ud) Côté laqué store / fenêtre(1 Ud)	Iluminación LED (X nivel de estante) LED Lighting (X level shelf) Eclairage LED (X niveau d'étagère)	Decoración exterior lacado Lacquered exterior decoration Décoration extérieure laqué	Tope estante metacrilato (X nivel de estante) Methacrylate shelf stop (X nivel de estante) Butée d'étagère méthacrylate (X nivel de estante)	Ventiladores electronicos Electronic fans Electronique ventilateurs	Paragolpes tubo inox Stainless steel bumper Pare-chocs acier inoxydable
RPG/RPS15333 12	155 €	77 €	173 €	34 €	81 €	75 €
RPG/RPS15333 18	155 €	115 €	207 €	56 €	124 €	108 €
RPG/RPS15333 25	155 €	148 €	303 €	66 €	164 €	137 €
RPG/RPS15333 37	155 €	242 €	345 €	99 €	247 €	217 €

Características técnicas y constructivas sujetas a variación sin previo aviso. / We reserve the right to change specifications without prior notice. / Sujet technique et la conception de modifications sans préavis.

Modelos RPG / RPG Models

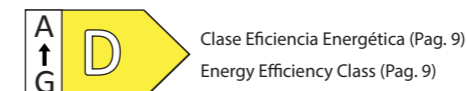

Clase Eficiencia Energética (Pag. 9)
Energy Efficiency Class (Pag. 9)

Modelos RPS / RPS Models

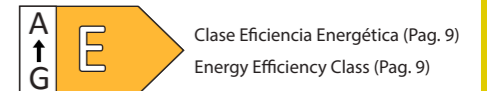

Clase Eficiencia Energética (Pag. 9)
Energy Efficiency Class (Pag. 9)



Laterales NO incluidos en PVP / Sides NOT included in PVP / Latéraux NON inclus dans PVP

JUEGO LAT. PANORAMICOS PANORAMIC SIDES KIT CÔTÉS PANORAMIQUE JEU	RP153	409 €	RP154	430 €	RP-155	452 €

	RPG15333 12 M	4.120 €		RPG15333 18 M	5.401 €		RPG15333 25 M	6.855 €		RPG15333 37 M	9.610 €
	RPS15333 12 M	2.805 €		RPS15333 18 M	3.504 €		RPS15333 25 M	4.108 €		RPS15333 37 M	5.190 €
	RPS15433 12 M	2.945 €		RPS15433 18 M	3.679 €		RPS15433 25 M	4.313 €		RPS15433 37 M	5.450 €
	RPS15533 12 M	3.122 €		RPS15533 18 M	3.900 €		RPS15533 25 M	4.572 €		RPS15533 37 M	5.776 €

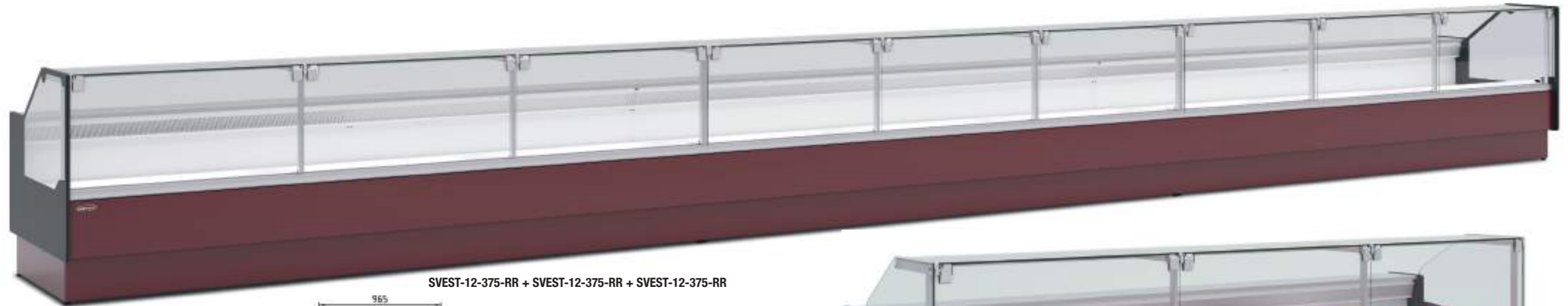

SVEST-12-375-RR + SVEST-12-375-RR + SVEST-12-375-RR

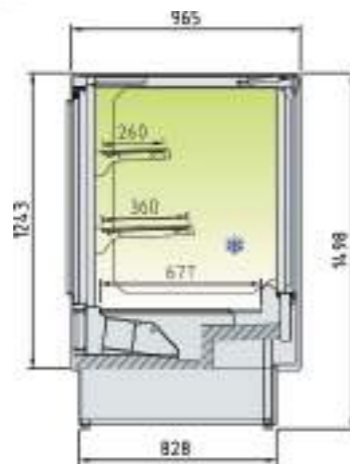
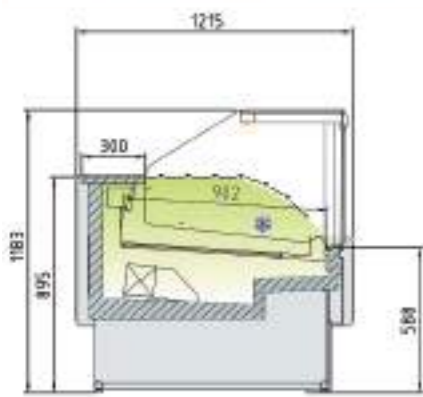

Detalle cristal frontal elevable
 Detail front glass lift
 Détail ascenseur en verre avant



SVEST-12-375-RR

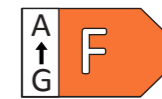

Clase Eficiencia Energética (Pag. 9)
 Energy Efficiency Class (Pag. 9)

Ver características técnicas en página 148 / See technical data in page 148 / Voir caractéristiques techniques page 148

Modelo	Longitud (sin costados)	Área estantes refrigerados m2	Superficie total exposicion (TDA)	Volumen neto
Model	Length (without sides)	Refrigerated shelf area m2	Total display area (TDA)	Net volume
Modèle	Longueur (sans côtés)	Zone d'étagères réfrigérées	Surface totale d'exposition (TDA)	Volume net (L)
SVEST-12-093-TC	937	0,63	1,17	459
SVEST-12-125-TC	1250	0,84	1,58	490
SVEST-12-125-RR	1250	1,05	1,29	241
SVEST-12-156-RR	1563	1,31	1,61	302
SVEST-12-187-RR	1875	1,57	1,93	362
SVEST-12-250-RR	2500	2,10	2,58	482
SVEST-12-312-RR	3125	2,62	3,22	603
SVEST-12-375-RR	3750	3,14	3,87	724
SVEST-12-AP90-RR	1562	1,31	1,70	302
SVEST-12-AN90-RR	1562	1,27	1,12	256

PVP de opcionales incluidos en equipo, no como repuesto / PVP of options included in the equipment, not as a spare part / PVP d'options incluses dans l'équipement, pas en tant que pièce de rechange
 Interior epoxy negro sin incremento de precio / Black epoxy interior without price increase / Intérieur époxy noir sans majoration de prix

OPCIONES · OPTIONS · OPTIONS

Modelo	Decoración exterior lacado (Lateral no incluido)	Iluminación led extra	Puertas Cierre Plexi	Cierre cortina	Separador genero	Separador ambiente	Paragolpes tubo inox	Plano exp. escalón
Model	Lacquered exterior decoration (Side not included)	Led lighting extra	Plexi slide Doors	Night blind Rideau nocturne	Separator genre	Separator enviroment	Stainless steel bumper (€ / m)	kit shelf exposure step
Modèle	Décoration extérieure laqué (Côté non inclus)	Éclairage led extra	Kit vitrage arrière coulissant plexi		Separation genre	Separation ambiance	Pare-chocs acier inoxydable(€/m)	Plano étape d'exposition
SVEST-12-125-RR	471 €	78 €	173 €	242 €	72 €	143 €	75 €	150 €
SVEST-12-156-RR	481 €	93 €	201 €	292 €	72 €	143 €	90 €	212 €
SVEST-12-187-RR	489 €	112 €	252 €	321 €	72 €	143 €	108 €	292 €
SVEST-12-250-RR	495 €	148 €	335 €	378 €	72 €	143 €	137 €	363 €
SVEST-12-312-RR	502 €	160 €	397 €	581 €	72 €	143 €	180 €	421 €
SVEST-12-375-RR	780 €	222 €	500 €	640 €	72 €	143 €	217 €	583 €
SVEST-12-AP/AN-90	502 €	80 €	271 €	-	72 €	143 €	-	-

Características técnicas y constructivas sujetas a variación sin previo aviso. / We reserve the right to change specifications without prior notice. / Sujet technique et la conception de modifications sans préavis.



SVEST-12-125-TC

LAT.ABS / ABS LAT. ESP. 30MM	LAT.PANORAMICOS / PANORAMIC LAT. ESP. 20MM
LPSVERR-D 244 €	LPSVERR-D 402 €
LPSVERR-I 244 €	LPSVERR-I 402 €
DECORACION LATERAL (1 UD) SIDE DECORATION KIT (1 UD) KIT DÉCORATION LATÉRALE (1 UD)	LPSTC-D 402 €
DLC 156 €	LPSTC-I 402 €

SVEST-12-093-TC 5.193 €	SVEST-12-125-TC 5.625 €

SVEST-12-AN90-RR 8.607 €	SVEST-12-AP90-RR 6.151 €

Laterales NO incluidos en PVP / Sides NOT included in PVP / Latéraux NON inclus dans PVP

SVEST-12-125-RR 3.522 €	SVEST-12-156-RR 3.944 €	SVEST-12-187-RR 4.215 €	SVEST-12-250-RR 5.171 €	SVEST-12-312-RR 6.099 €	SVEST-12-375-RR 6.678 €



SVEST-12-250-C + SVEST-12-250-C + SVEST-12-250-C

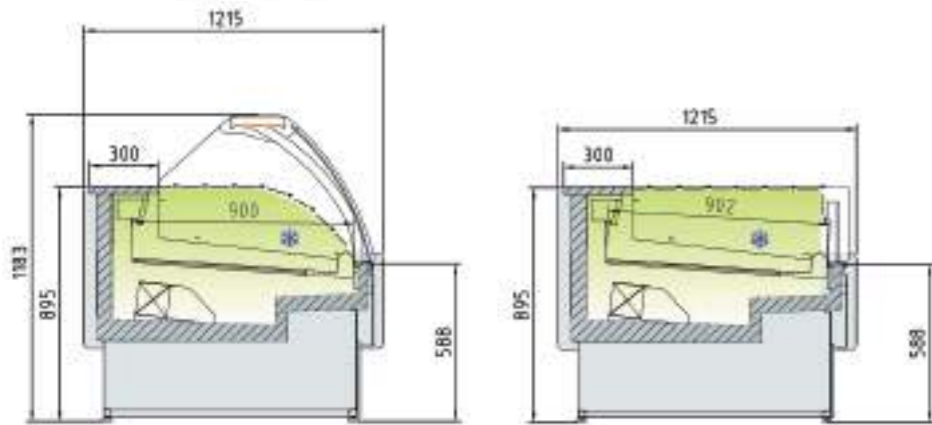

Ver características técnicas en página 148 / See technical data in page 148 / Voir caractéristiques techniques page 148



SVEST-12-250-C

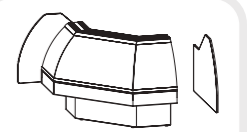

SVEST-12-AP90-C 6.799 €

Modelo	Longitud (sin costados)	Área estantes refrigerados m2	Superficie total exposicion (TDA)	Volumen neto
Model	Length (without sides)	Refrigerated shelf area m2	Total display area (TDA)	Net volume
Modèle	Longueur (sans côtés)	Zone d'étagères réfrigérées	Surface totale d'exposition (TDA)	Volume net (L)
SVEST-12-125-C	1250	1,05	1,00	241
SVEST-12-156-C	1563	1,31	1,61	302
SVEST-12-187-C	1875	1,57	1,50	362
SVEST-12-250-C	2500	2,10	2,00	482
SVEST-12-312-C	3125	2,62	2,50	603
SVEST-12-375-C	3750	3,14	3,01	724
SVEST-12-AP90-C	1562	1,31	1,35	302

230v 60Hz / 115v 60Hz. consultar - consult - consulter

PVP de opcionales incluidos en equipo, no como repuesto / PVP of options included in the equipment, not as a spare part / PVP d'options incluses dans l'équipement, pas en tant que pièce de rechange
 Interior epoxy negro sin incremento de precio / Black epoxy interior without price increase / Intérieur époxy noir sans majoration de prix

OPCIONES - OPTIONS - OPTIONS

Modelo	Decoración exterior lacado (Lateral no incluido)	Iluminación led extra	Puertas Cierre Plexi	Cierre cortina	Separador genero	Separador ambiente	Paragolpes tubo inox	Plano exp. escalón
Model	Lacquered exterior decoration (Side not included)	Led lighting extra	Plexi slide	Night blind	Separator genre	Separator enviroment	Stainless steel bumper	kit shelf exposure step
Modèle	Décoration extérieure laqué (Côté non inclus)	Éclairage led extra	Doors Kit vitrage arrière coulissant plexi	Rideau nocturne	Séparation genre	Séparation ambiance	Pare-chocs acier inoxydable(€/m)	Plano étape d'exposition
SVEST-12-125-C	471 €	78 €	173 €	242 €	72 €	143 €	75 €	150 €
SVEST-12-156-C	481 €	93 €	201 €	292 €	72 €	143 €	90 €	212 €
SVEST-12-187-C	489 €	112 €	252 €	321 €	72 €	143 €	108 €	292 €
SVEST-12-250-C	495 €	148 €	335 €	378 €	72 €	143 €	137 €	363 €
SVEST-12-312-C	502 €	160 €	397 €	581 €	72 €	143 €	180 €	421 €
SVEST-12-375-C	780 €	222 €	500 €	640 €	72 €	143 €	217 €	583 €
SVEST-12-AP90	502 €	80 €	271 €	-	72 €	143 €	-	-

Características técnicas y constructivas sujetas a variación sin previo aviso. / We reserve the right to change specifications without prior notice. / Sujet technique et la conception de modifications sans préavis.



Clase Eficiencia Energética (Pag. 9)
 Energy Efficiency Class (Pag. 9)

LAT.ABS / ABS LAT. LAT. ABS ESP. 30MM	LAT.PANORAMICOS / PANORAMIC LAT. LAT. PANORAMIQUES ESP. 20MM
LPSVERR-D 244 €	LPSVERR-D 402 €
LPSVERR-I 244 €	LPSVERR-I 402 €
DECORACION LATERAL (1 UD) SIDE DECORATION KIT (1 UD) KIT DÉCORATION LATÉRALE (1 UD)	
DLC 156 €	

Laterales NO incluidos en PVP / Sides NOT included in PVP / Latéraux NON inclus dans PVP

SVESAT-12-125 3.432 €	SVESAT-12-156 3.796 €	SVESAT-12-187 3.923 €	SVESAT-12-250 4.653 €	SVESAT-12-312 5.581 €	SVESAT-12-375 6.215 €
SVEST-12-125-C 3.460 €	SVEST-12-156-C 3.787 €	SVEST-12-187-C 4.144 €	SVEST-12-250-C 5.040 €	SVEST-12-312-C 6.127 €	SVEST-12-375-C 7.239 €

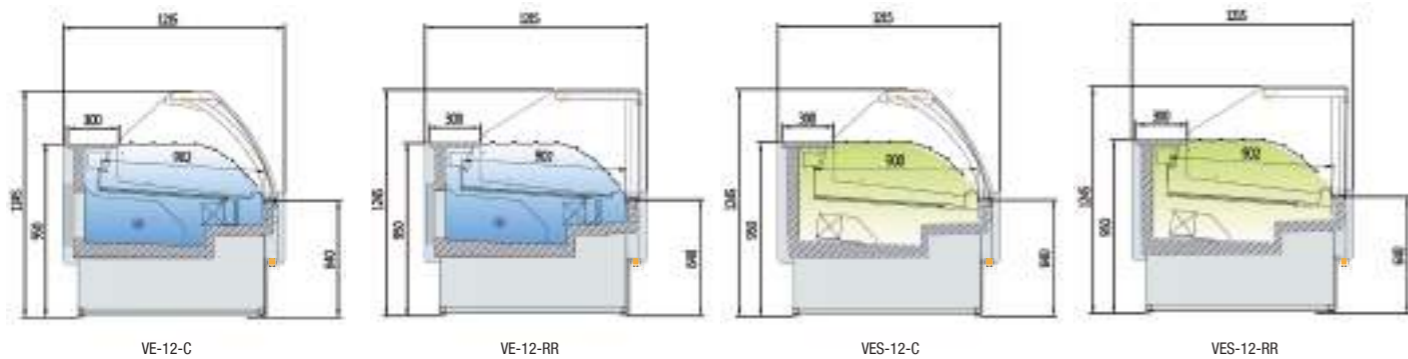

4000K 3000K RED FRESH



MODELOS CON RESERVA / MODELS WITH RESERVATION / RÉSERVE MODÈLES

MODELOS SIN RESERVA / MODELS WITHOUT RESERVATION / RÉSERVE SANS MODÈLES



Detalle cristal elevable
Liftable glass detail
Detail vitree elevable



Detalle repetidor temperatura
Display temperature detail
Detail température repeater

Ver características técnicas en página 148 / See technical data in page 148 / Voir caractéristiques techniques page 148

Modelo Modèle	Largo Longueur (mm)	Superficie de exposición Display area Surface d'exposition (m²)	Superficie total de exposición (TDA) Total display area (TDA) Surface totale de l'exposition (TDA) (m²)		Cámara VE Storage VE Stockage VE (lts.)	Puertas Doors Portes (Uds)	Potencia frig. Frig. Power Puissance frig. (W)	Consumo Nominal Nominal power Consommation nominale (W)	Refrigerante Coolant Réfrigérant
			(C)	(RR)					
VE / VES-12-10-TF	997	1,05	1	1,29	520	2 / 0	949	1054	R-290
VE / VES-12-13-TF	1310	1,05	1	1,29	520	2 / 0	949	1054	R-290
VE / VES-12-15-TF	1623	1,31	1,25	1,61	600	2 / 0	1012	1105	R-290
VE / VES-12-20-TF	1935	1,57	1,50	1,93	810	3 / 0	1419	1379	R-290
VE / VES-12-25-TF	2560	2,10	2	2,58	1100	4 / 0	1703	1417	R-290
VE / VES-12-30-TF	3185	2,62	2,5	3,22	1280	5 / 0	1931	1689	R-290
VE / VES-12-37-TF	3810	3,14	3,01	3,87	1620	6 / 0	2838	2136	R-290

230v 60Hz / 115v 60Hz. consultar - consult - consulter

*Modelos en HFC, consultar precio / HFC Models, consult prices / Modèles HFC, consulter prix

PVP de opcionales incluidos en equipo, no como repuesto / PVP of options included in the equipment, not as a spare part / PVP d'options incluses dans l'équipement, pas en tant que pièce de rechange

Modelo Modèle	OPCIONES - OPTIONS - OPTIONS		Cierre Plexi Plexi slide Kit vitrage plexi	Iluminación led extra Extra led lighting Éclairage Led extra	Cierre cortina Night blind Rideau nocturne	Neutra Neutral Neutre	Pre Instalación Remote Unit Groupe à distance
	1 decoración frontal / front decor / décoration frontal	2 Total decoración / Total decor / décoration total					
VE / VES-12-10-TF	140 €	460 €	118 €	57 €	175 €	-410 €	-120 €
VE / VES-12-13-TF	150 €	471 €	173 €	78 €	242 €	-460 €	-135 €
VE / VES-12-15-TF	164 €	481 €	201 €	93 €	292 €	-510 €	-145 €
VE / VES-12-20-TF	174 €	489 €	252 €	112 €	321 €	-615 €	-180 €
VE / VES-12-25-TF	184 €	495 €	335 €	148 €	378 €	-870 €	-205 €
VE / VES-12-30-TF	194 €	502 €	397 €	160 €	581 €	-995 €	-255 €
VE / VES-12-37-TF	275 €	780 €	500 €	222 €	640 €	-1.050 €	-310 €

Características técnicas y constructivas sujetas a variación sin previo aviso. / We reserve the right to change specifications without prior notice. / Sujet technique et la conception de modifications sans préavis.



VE-12-20-C-TF



VE-12-25-RR-TF

Clase Eficiencia Energética (Pag. 9)
Energy Efficiency Class (Pag. 9)

Laterales incluidos en PVP / Sides included in PVP / Latéraux inclus dans PVP

VE-12-10-C-TF	4.191 €	VE-12-13-C-TF	4.587 €	VE-12-15-C-TF	4.930 €	VE-12-20-C-TF	5.457 €	VE-12-25-C-TF	6.506 €	VE-12-30-C-TF	7.305 €	VE-12-37-C-TF	8.910 €
VES-12-10-C-TF	4.042 €	VES-12-13-C-TF	4.470 €	VES-12-15-C-TF	4.862 €	VES-12-20-C-TF	5.263 €	VES-12-25-C-TF	6.303 €	VES-12-30-C-TF	6.965 €	VES-12-37-C-TF	8.480 €
VE-12-10-RR-TF	4.272 €	VE-12-13-RR-TF	4.631 €	VE-12-15-RR-TF	5.074 €	VE-12-20-RR-TF	5.588 €	VE-12-25-RR-TF	6.701 €	VE-12-30-RR-TF	7.320 €	VE-12-37-RR-TF	9.215 €
VES-12-10-RR-TF	4.160 €	VES-12-13-RR-TF	4.470 €	VES-12-15-RR-TF	4.955 €	VES-12-20-RR-TF	5.390 €	VES-12-25-RR-TF	6.363 €	VES-12-30-RR-TF	7.137 €	VES-12-37-RR-TF	8.130 €

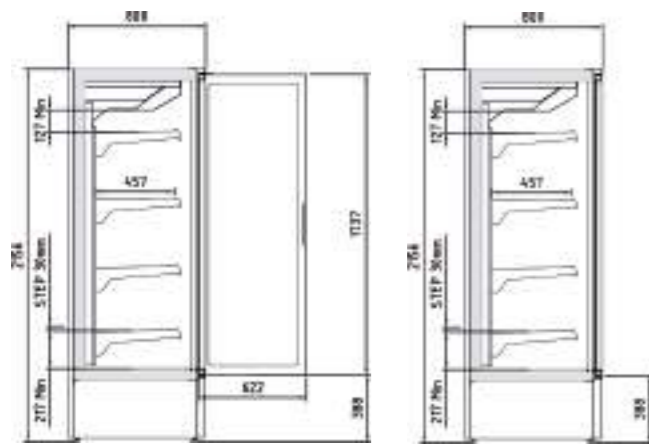

EFI PUERTA ABIERTA

EFI PUERTA CERRADA



Detalle costado ciego

Disponible modelos refrigeración y congelados
Available refrigerated and frozen models
Modèles réfrigérés et congelés disponibles



Detalle costado ventana

Solo modelos refrigeración
Refrigeration models only
Modèles de réfrigération uniquement



EFI 2R



Detalle barras carniceras (opcional)
Detail of butcher bars (optional)
Détail des bars de boucherie (facultatif)



EFI 4R

CARACTERÍSTICAS TÉCNICAS

- Mueble vertical grupo incorporado con capacidad y visibilidad optimizada del producto
- Puertas batientes sin marco y frontal completo de cristal con serigrafía mínima con sistema de cierre automático y burlete magnético (permanece abierta al superar los 90° de apertura)
- Dos posibilidades de configuración: Exterior blanco RAL 9003, negro RAL 9005
- Interior en acabado blanco RAL 9003
- Evaporador ventilado pintado en con recubrimiento anticorrosión
- Estantes regulables en altura y ángulo, con portaprecios de 40 mm incluidos
- Desescarche natural del evaporador
- Bandeja de evaporación automática
- Control electrónico
- Iluminación LED 24v 4000k en estantes
- Temperatura de producto, según EN-ISO-23953:
a. M1: -1°+5°C, apropiado para carnes, lácteos, delis y embutidos
- Clase climática 3 (25°C, 60 H.R)

TECHNICAL DATA

- Plug-in vertical cabinet with optimized capacity and visibility of the product
- Frameless swing doors with a full glass front with minimal serigraphy, with automatic closing system and magnetic gasket (remains open when opening more than 90°).
- Two configuration possibilities: Exterior white RAL 9003, black RAL 9005
- Interior in white RAL 9003 finish.
- Ventilated evaporator painted in EPOXY with anti-corrosion coating.
- Shelves adjustable in height and angle, with 40 mm price holders included
- Natural defrost of the evaporator
- Automatic evaporation tray
- Electronic control
- 24v 4000k LED lighting on shelves
- Product temperature, according to EN-ISO-23953:
a. M1: -1°+5°C, suitable for meat, dairy, delis and sausages
- Climatic class 3 (25°C, 60 H.R.)

CARACTÉRISTIQUES TECHNIQUES

- Unité verticale de groupe intégrée avec une capacité et une visibilité optimisées du produit
- Portes battantes sans cadre avec façade entièrement vitrée avec sérigraphie minimale, avec système de fermeture automatique et coupe-froid magnétique (reste ouvert lors d'une ouverture supérieure à 90°).
- Deux possibilités de configuration : Extérieur blanc RAL 9003, noir RAL 9005
- Intérieur finition blanc RAL 9003.
- Évaporateur ventilé peint en avec revêtement anti-corrosion.
- Étagères réglables en hauteur et en inclinaison, avec porteprix de 40 mm inclus
- Dégivrage naturel de l'évaporateur
- Plateau d'évaporation automatique
- Contrôle électronique
- Éclairage LED 24v 4000k sur les étagères
- Température du produit, selon EN-ISO-23953 :
a. M1 : -1°+5°C, convient pour la viande, les produits laitiers, les charcuteries et les saucisses
- Classe climatique 3 (25°C, 60 H.R.)

Modelo	Longitud (con costados)	Área estantes refrigerados	Superficie total exposición	Volumen neto	Volumen bruto	Estantes	Puertas	Potencia frigorífica	Consumo nominal	Refrigerante
Model	Length (with sides)	Refrigerated shelf area	Total display area	Net volume	Gross volume	Shelves	Doors	Cooling capacity	Nominal Power	Refrigerant
Modèle	Longueur (avec côtés)	Zone d'étagères réfrigérées	Surface totale d'exposition	Volume net	Volume brut	Étagères	Portes	Puissance frigorifique	Consommation nominale	Réfrigérant
	(mm)	m2	(TDA)	(L)	(L)	Uds. Units	Uds. Units	(W)	(W)	
EFI 1R	642	1,20	0,84	430	461	4	1	555	1132	R-290
EFI 2R	1282	2,72	1,68	859	1010	4	2	1192	1508	R-290
EFI 3R	1925	4,29	2,52	1253	1570	8	3	1528	1945	R-290
EFI 4R	2567	5,82	3,30	1667	2128	8	4	2384	3016	R-290

PVP de opcionales incluidos en equipo, no como repuesto / PVP of options included in the equipment, not as a spare part / PVP d'options incluses dans l'équipement, pas en tant que pièce de rechange
Interior epoxy negro sin incremento de precio / Black epoxy interior without price increase / Intérieur époxy noir sans majoration de prix

OPCIONES - OPTIONS - OPTIONS

Modelo	Estante adicional x nivel	Ventiladores electrónicos	Kit iluminación x nivel	Kit exterior lacado (Góndola + costados)	Kit soporte + 3 barras carniceras por estante	Gancho (1 ud.)
Model	Additional shelf x level	Electronic fans	Illumination kit x level	Lacquered exterior kit (Gondola + sides)	Support kit + 3 butcher bars per shelf	Hook (1 unit)
Modèle	Étagère supplémentaire x niveau	Electronique ventilateurs	Kit d'éclairage x niveau	Kit extérieur laqué (Gondole + côtés)	Kit support + 3 barres de boucher par étagère	Crochet (1 ud.)
EFI 1R	117 €	65 €	52 €	441 €	158 €	35 €
EFI 2R	156 €	81 €	75 €	456 €	158 €	35 €
EFI 3R	250 €	123 €	112 €	469 €	158 €	35 €
EFI 4R	312 €	163 €	151 €	475 €	158 €	35 €

Características técnicas y constructivas sujetas a variación sin previo aviso. / We reserve the right to change specifications without prior notice. / Sujet technique et la conception de modifications sans préavis.

Laterales incluidos en PVP / Sides included in PVP / Latéraux inclus dans PVP



Clase Eficiencia Energética (Pag. 9)
Energy Efficiency Class (Pag. 9)

EFI 1R 2.980 €	EFI 2R 3.880 €	EFI 3R 4.890 €	EFI 4R 6.100 €

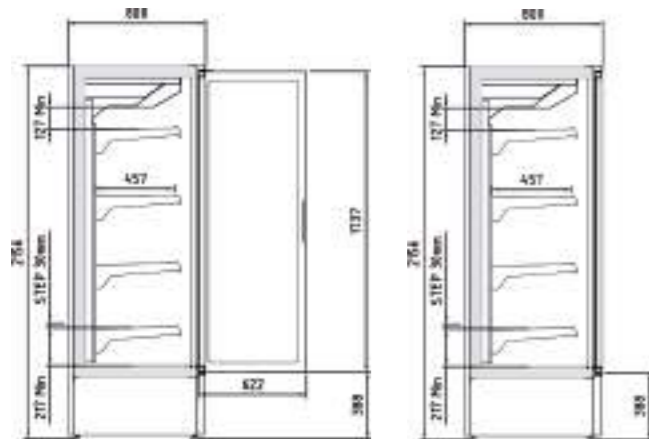

EFI PUERTA ABIERTA

EFI PUERTA CERRADA



Decoración exterior total blanco o negro sin incremento de precio
Total exterior decoration white or black without price increase
Décoration extérieure totale blanc ou noir sans majoration de prix

CARACTERÍSTICAS TÉCNICAS

- Mueble vertical grupo incorporado con capacidad y visibilidad optimizada del producto
- Puertas batientes sin marco y frontal completo de cristal con serigrafía mínima con sistema de cierre automático y burlete magnético (permanece abierta al superar los 90° de apertura)
- Dos posibilidades de configuración: Exterior blanco RAL 9003, negro RAL 9005
- Interior en acabado blanco RAL 9003
- Evaporador ventilado pintado en con recubrimiento anticorrosión
- Estantes regulables en altura y ángulo, con portaprecios de 40 mm incluidos
- Desescarche natural del evaporador para refrigeración, desescarche por gas caliente para mantenimiento congelados
- Bandeja de evaporación automática
- Control electrónico
- Iluminación LED 24v 4000k en estantes
- Temperatura de producto, según EN-ISO-23953: b. L1: -15°-18°C, apropiado para producto congelado
- Clase climática 3 (25°C, 60 H.R)

TECHNICAL DATA

- Plug-in vertical cabinet with optimized capacity and visibility of the product
- Frameless swing doors with a full glass front with minimal serigraphy, with automatic closing system and magnetic gasket (remains open when opening more than 90°).
- Two configuration possibilities: Exterior white RAL 9003, black RAL 9005
- Interior in white RAL 9003 finish.
- Ventilated evaporator painted in EPOXY with anti-corrosion coating.
- Shelves adjustable in height and angle, with 40 mm price holders included
- Natural defrost of the evaporator for refrigeration, defrost by hot gas for frozen maintenance.
- Automatic evaporation tray
- Electronic control
- 24v 4000k LED lighting on shelves
- Product temperature, according to EN-ISO-23953: b. L1: -15°-18°C, appropriate for frozen product
- Climatic class 3 (25°C, 60 H.R.)

CARACTÉRISTIQUES TECHNIQUES

- Unité verticale de groupe intégrée avec une capacité et une visibilité optimisées du produit
- Portes battantes sans cadre avec façade entièrement vitrée avec sérigraphie minimale, avec système de fermeture automatique et coupe-froid magnétique (reste ouvert lors d'une ouverture supérieure à 90°).
- Deux possibilités de configuration : Extérieur blanc RAL 9003, noir RAL 9005
- Intérieur finition blanc RAL 9003.
- Évaporateur ventilé peint en avec revêtement anti-corrosion.
- Étagères réglables en hauteur et en inclinaison, avec porte-prix de 40 mm inclus
- Dégivrage naturel de l'évaporateur pour la réfrigération, dégivrage par gaz chaud pour le maintien hors gel.
- Plateau d'évaporation automatique
- Contrôle électronique
- Éclairage LED 24v 4000k sur les étagères
- Température du produit, selon EN-ISO-23953 : b. L1 : -15°-18°C, approprié pour les produits surgelés
- Classe climatique 3 (25°C, 60 H.R.)

VITRINA EFIMARKET H 2160 MM MANTENIMIENTO CONGELADOS

FROZEN MAINTENANCE EFIMARKET RANGE H 2160 MM · ENTRETIEN GELÉ EFIMARKET GAMME H 2160 MM



Estante varilla opcional
Optional rod shelf
Tablette à tiges en option



EFI 3C

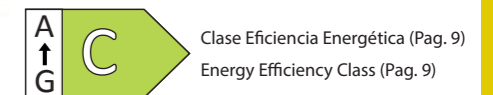

Clase Eficiencia Energética (Pag. 9)
Energy Efficiency Class (Pag. 9)

Modelo	Longitud (con costados)	Área estantes refrigerados	Superficie total exposición	Volumen neto	Volumen bruto	Estantes	Puertas	Potencia frigorífica	Consumo nominal	Refrigerante
Model	Length (with sides)	Refrigerated shelf area	Total display area	Net volume	Gross volume	Shelves	Doors	Cooling capacity	Nominal Power	Refrigerant
Modèle	Longueur (avec côtés)	Zone d'étagères réfrigérées	Surface totale d'exposition	Volume net	Volume brut	Étagères	Portes	Puissance frigorifique	Consommation nominale	Réfrigérant
	(mm)	m2	(TDA)	(L)	(L)	Uds. Units	Uds. Units	(W)	(W)	
EFI 1C	642	1,20	0,84	430	461	4	1	495	474	R-290
EFI 2C	1282	2,72	1,68	859	1010	4	2	924	1733	R-290
EFI 3C	1925	4,29	2,52	1253	1570	8	3	1242	2162	R-290
EFI 4C	2567	5,82	3,30	1667	2128	8	4	1848	3466	R-290

PVP de opcionales incluidos en equipo, no como repuesto / PVP of options included in the equipment, not as a spare part / PVP d'options incluses dans l'équipement, pas en tant que pièce de rechange
Interior epoxy negro sin incremento de precio / Black epoxy interior without price increase / Intérieur époxy noir sans majoration de prix

OPCIONES · OPTIONS · OPTIONS

Modelo	Estante adicional x nivel	Ventiladores electrónicos	Kit iluminación x nivel	Kit exterior lacado (Góndola + costados)	Estante varilla
Model	Additional shelf x level	Electronic fans	Illumination kit x level	Lacquered exterior kit (Gondola + sides)	Rod shelf
Modèle	Étagère supplémentaire x niveau	Electronique ventilateurs	Kit d'éclairage x niveau	Kit extérieur laqué (Gondole + côtés)	Etagère tringles
EFI 1C	117 €	65 €	52 €	441 €	87 €
EFI 2C	156 €	81 €	75 €	456 €	87 €
EFI 3C	250 €	123 €	112 €	469 €	87 €
EFI 4C	312 €	163 €	151 €	475 €	87 €

Características técnicas y constructivas sujetas a variación sin previo aviso. / We reserve the right to change specifications without prior notice. / Sujet technique et la conception de modifications sans préavis.

Laterales incluidos en PVP / Sides included in PVP / Latéraux inclus dans PVP

EFI 1C 3.971 €	EFI 2C 5.290 €	EFI 3C 6.710 €	EFI 4C 8.230 €

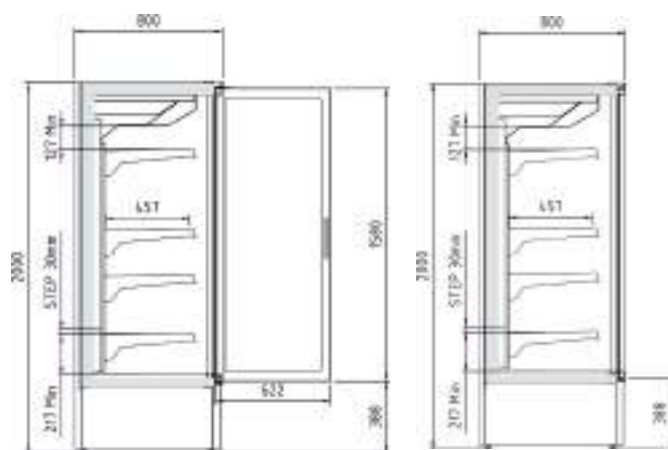

EFIL PUERTA ABIERTA

EFIL PUERTA CERRADA



Detalle barras carniceras (opcional)
Detail of butcher bars (optional)
Détail des bars de boucherie (facultatif)

CARACTERÍSTICAS TÉCNICAS

- Mueble vertical grupo incorporado con capacidad y visibilidad optimizada del producto
- Puertas batientes sin marco y frontal completo de cristal con serigrafía mínima con sistema de cierre automático y burlete magnético (permanece abierta al superar los 90° de apertura)
- Dos posibilidades de configuración: Exterior blanco RAL 9003, negro RAL 9005
- Interior en acabado blanco RAL 9003
- Evaporador ventilado pintado en con recubrimiento anticorrosión
- Estantes regulables en altura y ángulo, con portaprecios de 40 mm incluidos
- Desescarche natural del evaporador para refrigeración, desescarche por gas caliente para mantenimiento congelados
- Bandeja de evaporación automática
- Control electrónico
- Iluminación LED 24v 4000k en estantes
- Temperatura de producto, según EN-ISO-23953:
a. M1: -1°+5°C, apropiado para carnes, lácteos, delis y embutidos
- Clase climática 3 (25°C, 60 H.R)

TECHNICAL DATA

- Plug-in vertical cabinet with optimized capacity and visibility of the product
- Frameless swing doors with a full glass front with minimal serigraphy, with automatic closing system and magnetic gasket (remains open when opening more than 90°).
- Two configuration possibilities: Exterior white RAL 9003, black RAL 9005
- Interior in white RAL 9003 finish.
- Ventilated evaporator painted in EPOXY with anti-corrosion coating.
- Shelves adjustable in height and angle, with 40 mm price holders included
- Natural defrost of the evaporator for refrigeration, defrost by hot gas for frozen maintenance.
- Automatic evaporation tray
- Electronic control
- 24v 4000k LED lighting on shelves
- Product temperature, according to EN-ISO-23953:
a. M1: -1°+5°C, suitable for meat, dairy, delis and sausages
b. L1: -15°-18°C, appropriate for frozen product
- Climatic class 3 (25°C, 60 H.R.)

CARACTÉRISTIQUES TECHNIQUES

- Unité verticale de groupe intégrée avec une capacité et une visibilité optimisées du produit
- Portes battantes sans cadre avec façade entièrement vitrée avec sérigraphie minimale, avec système de fermeture automatique et coupe-froid magnétique (reste ouvert lors d'une ouverture supérieure à 90°).
- Deux possibilités de configuration : Extérieur blanc RAL 9003, noir RAL 9005
- Intérieur finition blanc RAL 9003.
- Évaporateur ventilé peint en avec revêtement anti-corrosion.
- Étagères réglables en hauteur et en inclinaison, avec porte-prix de 40 mm inclus
- Dégivrage naturel de l'évaporateur pour la réfrigération, dégivrage par gaz chaud pour le maintien hors gel.
- Plateau d'évaporation automatique
- Contrôle électronique
- Éclairage LED 24v 4000k sur les étagères
- Température du produit, selon EN-ISO-23953 :
a. M1 : -1°+5°C, convient pour la viande, les produits laitiers, les charcuteries et les saucisses
b. L1 : -15°-18°C, approprié pour les produits surgelés
- Classe climatique 3 (25°C, 60 H.R.)

Modelo	Longitud (con costados)	Área estantes refrigerados	Superficie total exposición	Volumen neto	Volumen bruto	Estantes	Puertas	Potencia frigorífica	Consumo nominal	Refrigerante
Model	Length (with sides)	Refrigerated shelf area	Total display area	Net volume	Gross volume	Shelves	Doors	Cooling capacity	Nominal Power	Refrigerant
Modèle	Longueur (avec côtés)	Zone d'étagères réfrigérées	Surface totale d'exposition	Volume net	Volume brut	Étagères	Portes	Puissance frigorifique	Consommation nominale	Réfrigérant
	(mm)	m2	(TDA)	(L)	(L)	Uds. Units	Uds. Units	(W)	(W)	
EFIL1R	642	1,20	0,78	398	428	4	1	555	1132	R-290
EFIL 2R	1282	2,72	1,55	797	937	4	2	1192	1508	R-290
EFIL 3R	1925	4,29	2,33	1162	1456	8	3	1528	1945	R-290
EFIL 4R	2567	5,82	3,06	1546	1974	8	4	2384	3016	R-290

PVP de opcionales incluidos en equipo, no como repuesto / PVP of options included in the equipment, not as a spare part / PVP d'options incluses dans l'équipement, pas en tant que pièce de rechange
Interior epoxy negro sin incremento de precio / Black epoxy interior without price increase / Intérieur époxy noir sans majoration de prix

OPCIONES - OPTIONS - OPTIONS

Modelo	Estante adicional x nivel	Ventiladores electrónicos	Kit iluminación x nivel	Kit exterior lacado (Góndola + costados)	Kit soporte + 3 barras carniceras por estante	Gancho (1 ud.)
Model	Additional shelf x level	Electronic fans	Illumination kit x level	Lacquered exterior kit (Gondola + sides)	Support kit + 3 butcher bars per shelf	Hook (1 unit)
Modèle	Étagère supplémentaire x niveau	Electronique ventilateurs	Kit d'éclairage x niveau	Kit extérieur laqué (Gondole + côtés)	Kit support + 3 barres de boucher par étagère	Crochet (1 ud.)
EFIL 1R	117 €	65 €	52 €	441 €	158 €	35 €
EFIL 2R	156 €	81 €	75 €	456 €	158 €	35 €
EFIL 3R	250 €	123 €	112 €	469 €	158 €	35 €
EFIL 4R	312 €	163 €	151 €	475 €	158 €	35 €

Características técnicas y constructivas sujetas a variación sin previo aviso. / We reserve the right to change specifications without prior notice. / Sujet technique et la conception de modifications sans préavis.



EFIL 3R

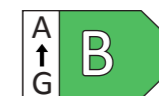

Clase Eficiencia Energética (Pag. 9)
Energy Efficiency Class (Pag. 9)

Laterales incluidos en PVP / Sides included in PVP / Latéraux inclus dans PVP

EFIL 1R 2.904 €	EFIL 2R 3.810 €	EFIL 3R 4.765 €	EFIL 4R 5.980 €

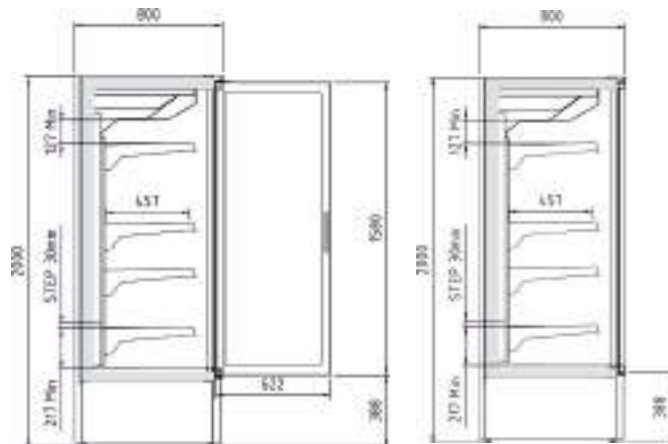

EFIL PUERTA ABIERTA

EFIL PUERTA CERRADA



Decoración exterior total blanco o negro sin incremento de precio
Total exterior decoration white or black without price increase
Décoration extérieure totale blanc ou noir sans majoration de prix



Estante varilla opcional
Optional rod shelf
Tablette à tiges en option

CARACTERÍSTICAS TÉCNICAS

- Mueble vertical grupo incorporado con capacidad y visibilidad optimizada del producto
- Puertas batientes sin marco y frontal completo de cristal con serigrafía mínima con sistema de cierre automático y burlete magnético (permanece abierta al superar los 90° de apertura)
- Dos posibilidades de configuración: Exterior blanco RAL 9003, negro RAL 9005
- Interior en acabado blanco RAL 9003
- Evaporador ventilado pintado en con recubrimiento anticorrosión
- Estantes regulables en altura y ángulo, con portaprecios de 40 mm incluidos
- Desescarche por gas caliente para mantenimiento congelados
- Bandeja de evaporación automática
- Control electrónico
- Iluminación LED 24v 4000k en estantes
- Temperatura de producto, según EN-ISO-23953: b. L1: -15°-18°C, apropiado para producto congelado
- Clase climática 3 (25°C, 60 H.R.)

TECHNICAL DATA

- Plug-in vertical cabinet with optimized capacity and visibility of the product
- Frameless swing doors with a full glass front with minimal serigraphy, with automatic closing system and magnetic gasket (remains open when opening more than 90°).
- Two configuration possibilities: Exterior white RAL 9003, black RAL 9005
- Interior in white RAL 9003 finish.
- Ventilated evaporator painted in EPOXY with anti-corrosion coating.
- Shelves adjustable in height and angle, with 40 mm price holders included
- Defrost by hot gas for frozen maintenance.
- Automatic evaporation tray
- Electronic control
- 24v 4000k LED lighting on shelves
- Product temperature, according to EN-ISO-23953: b. L1: -15°-18°C, appropriate for frozen product
- Climatic class 3 (25°C, 60 H.R.)

CARACTÉRISTIQUES TECHNIQUES

- Unité verticale de groupe intégrée avec une capacité et une visibilité optimisées du produit
- Portes battantes sans cadre avec façade entièrement vitrée avec sérigraphie minimale, avec système de fermeture automatique et coupe-froid magnétique (reste ouvert lors d'une ouverture supérieure à 90°).
- Deux possibilités de configuration : Extérieur blanc RAL 9003, noir RAL 9005
- Intérieur finition blanc RAL 9003.
- Évaporateur ventilé peint en avec revêtement anti-corrosion.
- Étagères réglables en hauteur et en inclinaison, avec porte-prix de 40 mm inclus
- Dégivrage par gaz chaud pour le maintien hors gel.
- Plateau d'évaporation automatique
- Contrôle électronique
- Éclairage LED 24v 4000k sur les étagères
- Température du produit, selon EN-ISO-23953 : b. L1 : -15°-18°C, approprié pour les produits surgelés
- Classe climatique 3 (25°C, 60 H.R.)



EFIL 1C



EFIL 2C

Kit lacado exterior (incremento de precio)
Exterior lacquered kit (price increase)
Kit laqué extérieur (augmentation de prix)

Modelo	Longitud (con costados)	Área estantes refrigerados	Superficie total exposición	Volumen neto	Volumen bruto	Estantes	Puertas	Potencia frigorífica	Consumo nominal	Refrigerante
Model	Length (with sides)	Refrigerated shelf area	Total display area	Net volume	Gross volume	Shelves	Doors	Cooling capacity	Nominal Power	Refrigerant
Modèle	Longueur (avec côtés)	Zone d'étagères réfrigérées	Surface totale d'exposition	Volume net	Volume brut	Étagères	Portes	Puissance frigorifique	Consommation nominale	Réfrigérant
	(mm)	m2	(TDA)	(L)	(L)	Uds. Units	Uds. Units	(W)	(W)	
EFIL 1C	642	1,20	0,78	398	428	4	1	495	474	R-290
EFIL 2C	1282	2,72	1,55	797	937	4	2	924	1733	R-290
EFIL 3C	1925	4,29	2,33	1162	1456	8	3	1242	2162	R-290
EFIL 4C	2567	5,82	3,06	1546	1974	8	4	1848	3466	R-290

PVP de opcionales incluidos en equipo, no como repuesto / PVP of options included in the equipment, not as a spare part / PVP d'options incluses dans l'équipement, pas en tant que pièce de rechange
Interior epoxy negro sin incremento de precio / Black epoxy interior without price increase / Intérieur époxy noir sans majoration de prix

OPCIONES · OPTIONS · OPTIONS

Modelo	Estante adicional x nivel	Ventiladores electrónicos	Kit iluminación x nivel	Kit exterior lacado (Góndola + costados)	Estante varilla
Model	Additional shelf x level	Electronic fans	Illumination kit x level	Lacquered exterior kit (Gondola + sides)	Rod shelf
Modèle	Étagère supplémentaire x niveau	Electronique ventilateurs	Kit d'éclairage x niveau	Kit extérieur laqué (Gondole + côtés)	Etagère tringles
EFIL 1C	117 €	65 €	52 €	441 €	87 €
EFIL 2C	156 €	81 €	75 €	456 €	87 €
EFIL 3C	250 €	123 €	112 €	469 €	87 €
EFIL 4C	312 €	163 €	151 €	475 €	87 €

Características técnicas y constructivas sujetas a variación sin previo aviso. / We reserve the right to change specifications without prior notice. / Sujet technique et la conception de modifications sans préavis.

Laterales incluidos en PVP / Sides included in PVP / Latéraux inclus dans PVP

EFIL 1C 3.870 €	EFIL 2C 5.155 €	EFIL 3C 6.539 €	EFIL 4C 8.055 €

A
↑
G
C
Clase Eficiencia Energética (Pag. 9)
Energy Efficiency Class (Pag. 9)

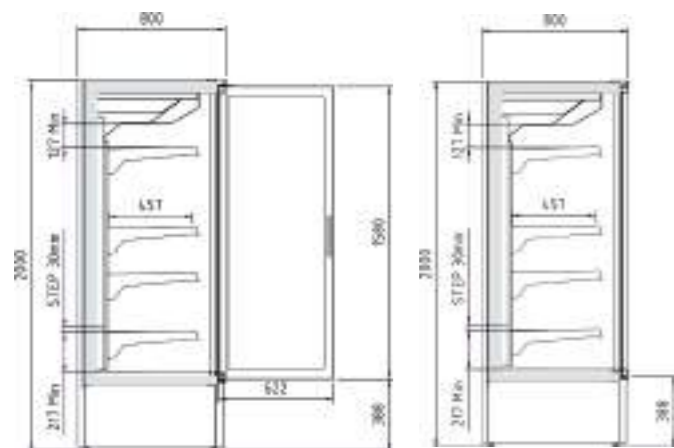

EFIL PUERTA ABIERTA

EFIL PUERTA CERRADA



Detalle costado ciego

Disponible modelos refrigeración y congelados
Available refrigerated and frozen models
Modèles réfrigérés et congelés disponibles

Detalle costado ventana

Solo modelos refrigeración
Refrigeration models only
Modèles de réfrigération uniquement

CARACTERÍSTICAS TÉCNICAS

- Mueble vertical grupo incorporado con capacidad y visibilidad optimizada del producto
- Puertas batientes sin marco y frontal completo de cristal con serigrafía mínima con sistema de cierre automático y burlete magnético (permanece abierta al superar los 90° de apertura)
- Dos posibilidades de configuración: Exterior blanco RAL 9003, negro RAL 9005
- Interior en acabado blanco RAL 9003
- Evaporador ventilado pintado en con recubrimiento anticorrosión
- Estantes regulables de cristal en altura y ángulo, con portaprecios de 40 mm incluidos
- Desescarche natural del evaporador
- Bandeja de evaporación automática
- Control electrónico
- Iluminación LED 24v 4000k en estantes
- Temperatura de producto, según EN-ISO-23953: a. M1: -1°+5°C, apropiado para carnes, lácteos, delis y embutidos
- Clase climática 3 (25°C, 60 H.R)

TECHNICAL DATA

- Plug-in vertical cabinet with optimized capacity and visibility of the product
- Frameless swing doors with a full glass front with minimal serigraphy, with automatic closing system and magnetic gasket (remains open when opening more than 90°).
- Two configuration possibilities: Exterior white RAL 9003, black RAL 9005
- Interior in white RAL 9003 finish.
- Ventilated evaporator painted in EPOXY with anti-corrosion coating.
- Adjustable glass shelves in height and angle, with 40 mm price holders included
- Natural defrost of the evaporator
- Automatic evaporation tray
- Electronic control
- 24v 4000k LED lighting on shelves
- Product temperature, according to EN-ISO-23953: a. M1: -1°+5°C, suitable for meat, dairy, delis and sausages
- Climatic class 3 (25°C, 60 H.R.)

CARACTÉRISTIQUES TECHNIQUES

- Unité verticale de groupe intégrée avec une capacité et une visibilité optimisées du produit
- Portes battantes sans cadre avec façade entièrement vitrée avec sérigraphie minimale, avec système de fermeture automatique et coupe-froid magnétique (reste ouvert lors d'une ouverture supérieure à 90°).
- Deux possibilités de configuration : Extérieur blanc RAL 9003, noir RAL 9005
- Intérieur finition blanc RAL 9003.
- Évaporateur ventilé peint en avec revêtement anti-corrosion.
- Tablettes en verre réglables en hauteur et en angle, avec supports de prix de 40 mm inclus
- Dégivrage naturel de l'évaporateur
- Plateau d'évaporation automatique
- Contrôle électronique
- Éclairage LED 24v 4000k sur les étagères
- Température du produit, selon EN-ISO-23953 : a. M1 : -1°+5°C, convient pour la viande, les produits laitiers, les charcuteries et les saucisses
- Classe climatique 3 (25°C, 60 H.R.)

VITRINA EFIMARKET H 2000 MM REFRIGERACIÓN PASTELERÍA

BAKERY REFRIGERATION EFIMARKET RANGE H 2000 MM · PÂTISSERIE RÉFRIGÉRATION EFIMARKET GAMME H 2000 MM



EFILP 2R LV



Detalle estante de cristal
Glass shelf detail
Détail Tablette en verre



EFILP 3R

Modelo	Longitud (con costados)	Área estantes refrigerados	Superficie total exposición	Volumen neto	Volumen bruto	Estantes	Puertas	Potencia frigorífica	Consumo nominal	Refrigerante
Model	Length (with sides)	Refrigerated shelf area	Total display area	Net volume	Gross volume	Shelves	Doors	Cooling capacity	Nominal Power	Refrigerant
Modèle	Longueur (avec côtés)	Zone d'étagères réfrigérées	Surface totale d'exposition	Volume net	Volume brut	Étagères	Portes	Puissance frigorifique	Consommation nominale	Réfrigérant
	(mm)	m2	(TDA)	(L)	(L)	Uds. Units	Uds. Units	(W)	(W)	
EFILP 1R	642	1,20	0,78	398	428	4	1	555	1132	R-290
EFILP 2R	1282	2,72	1,55	797	937	4	2	1192	1508	R-290
EFILP 3R	1925	4,29	2,33	1162	1456	8	3	1528	1945	R-290

PVP de opcionales incluidos en equipo, no como repuesto / PVP of options included in the equipment, not as a spare part / PVP d'options incluses dans l'équipement, pas en tant que pièce de rechange
Interior epoxy negro sin incremento de precio / Black epoxy interior without price increase / Intérieur époxy noir sans majoration de prix

OPCIONES · OPTIONS · OPTIONS

Modelo	Estante adicional x nivel	Ventiladores electrónicos	Kit iluminación x nivel	Interior acero inox brillo	Kit exterior lacado (Góndola + costados)
Model	Additional shelf x level	Electronic fans	Illumination kit x level	Bright stainless steel interior	Lacquered exterior kit (Gondola + sides)
Modèle	Étagère supplémentaire x niveau	Electronique ventilateurs	Kit d'éclairage x niveau	Intérieur en acier inoxydable brillant	Kit extérieur laqué (Gondole + côtés)
EFILP 1R	117 €	65 €	52 €	304 €	441 €
EFILP 2R	156 €	81 €	75 €	525 €	456 €
EFILP 3R	250 €	123 €	112 €	948 €	469 €

Características técnicas y constructivas sujetas a variación sin previo aviso. / We reserve the right to change specifications without prior notice. / Sujet technique et la conception de modifications sans préavis.

Laterales incluidos en PVP / Sides included in PVP / Latéraux inclus dans PVP

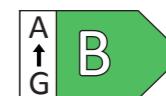

Clase Eficiencia Energética (Pag. 9)
Energy Efficiency Class (Pag. 9)



EFILP 1R **3.405 €**

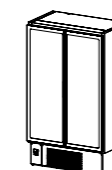

EFILP 2R **4.450 €**

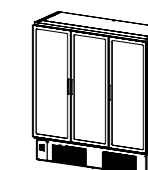

EFILP 3R **5.480 €**

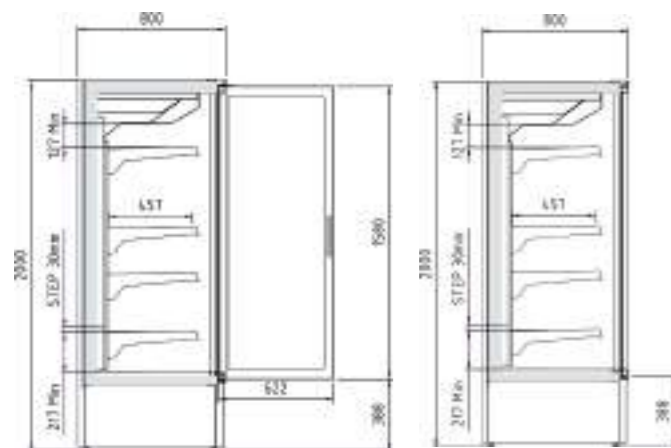

EFIL PUERTA ABIERTA

EFIL PUERTA CERRADA



Detalle costado ciego

Disponible modelos refrigeración y congelados
Available refrigerated and frozen models
Modèles réfrigérés et congelés disponibles

Detalle costado ventana

Solo modelos refrigeración
Refrigeration models only
Modèles de réfrigération uniquement

CARACTERÍSTICAS TÉCNICAS

- Mueble vertical grupo incorporado con capacidad y visibilidad optimizada del producto
- Puertas batientes sin marco y frontal completo de cristal con serigrafía mínima con sistema de cierre automático y burlete magnético (permanece abierta al superar los 90° de apertura)
- Dos posibilidades de configuración: Exterior blanco RAL 9003, negro RAL 9005
- Interior en acero inox AISI-316
- Evaporador ventilado pintado con tratamiento de cataforesis
- Estantes perforados regulables en altura y ángulo, con portaprecios de 40 mm incluidos
- Desescarche natural del evaporador para refrigeración
- Bandeja de evaporación automática
- Control electrónico
- Iluminación LED 24v 4000k en estantes
- Temperatura de producto, según EN-ISO-23953: a. M1: -1°+5°C, apropiado para carnes, lácteos, delis y embutidos
- Clase climática 3 (25°C, 60 H.R)

TECHNICAL DATA

- Plug-in vertical cabinet with optimized capacity and visibility of the product
- Frameless swing doors with a full glass front with minimal serigraphy, with automatic closing system and magnetic gasket (remains open when opening more than 90°).
- Two configuration possibilities: Exterior white RAL 9003, black RAL 9005
- AISI-316 stainless steel interior
- Painted ventilated evaporator with cataphoresis treatment
- Perforated shelves adjustable in height and angle, with 40 mm price holders included
- Natural defrost of the evaporator for refrigeration
- Automatic evaporation tray
- Electronic control
- 24v 4000k LED lighting on shelves
- Product temperature, according to EN-ISO-23953: a. M1: -1°+5°C, suitable for meat, dairy, delis and sausages
- Climatic class 3 (25°C, 60 H.R.)

CARACTÉRISTIQUES TECHNIQUES

- Unité verticale de groupe intégrée avec une capacité et une visibilité optimisées du produit
- Portes battantes sans cadre avec façade entièrement vitrée avec sérigraphie minimale, avec système de fermeture automatique et coupe-froid magnétique (reste ouvert lors d'une ouverture supérieure à 90°).
- Deux possibilités de configuration : Extérieur blanc RAL 9003, noir RAL 9005
- Intérieur en acier inoxydable AISI-316
- Évaporateur ventilé peint avec traitement cataphorèse
- Étagères perforé réglables en hauteur et en inclinaison, avec porte-prix de 40 mm inclus
- Dégivrage naturel de l'évaporateur pour la réfrigération
- Plateau d'évaporation automatique
- Contrôle électronique
- Éclairage LED 24v 4000k sur les étagères
- Température du produit, selon EN-ISO-23953 : a. M1 : -1°+5°C, convient pour la viande, les produits laitiers, les charcuteries et les saucisses
- Classe climatique 3 (25°C, 60 H.R.)



Detalle estante de cristal (Sin incremento de precio)
Glass shelf detail (No price increase)
Détail Tablette en verre (Pas d'augmentation de prix)



EFILQ 2R

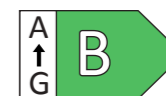

Clase Eficiencia Energética (Pag. 9)
Energy Efficiency Class (Pag. 9)

Modelo	Longitud (con costados)	Área estantes refrigerados	Superficie total exposición	Volumen neto	Volumen bruto	Estantes	Puertas	Potencia frigorífica	Consumo nominal	Refrigerante
Model	Length (with sides)	Refrigerated shelf area	Total display area	Net volume	Gross volume	Shelves	Doors	Cooling capacity	Nominal Power	Refrigerant
Modèle	Longueur (avec côtés)	Zone d'étagères réfrigérées	Surface totale d'exposition	Volume net	Volume brut	Étagères	Portes	Puissance frigorifique	Consommation nominale	Réfrigérant
	(mm)	m ²	(TDA)	(L)	(L)	Uds. Units	Uds. Units	(W)	(W)	
EFILQ 1R	642	1,20	0,78	398	428	4	1	555	1132	R-290
EFILQ 2R	1282	2,72	1,55	797	937	4	2	1192	1508	R-290
EFILQ 3R	1925	4,29	2,33	1162	1456	8	3	1528	1945	R-290

PVP de opcionales incluidos en equipo, no como repuesto / PVP of options included in the equipment, not as a spare part / PVP d'options incluses dans l'équipement, pas en tant que pièce de rechange
Interior epoxy negro sin incremento de precio / Black epoxy interior without price increase / Intérieur époxy noir sans majoration de prix

OPCIONES - OPTIONS - OPTIONS

Modelo	Estante adicional x nivel	Ventiladores electrónicos	Kit iluminación x nivel	Kit exterior lacado (Góndola + costados)
Model	Additional shelf x level	Electronic fans	Ilumination kit x level	Lacquered exterior kit (Gondola + sides)
Modèle	Étagère supplémentaire x niveau	Electronique ventilateurs	Kit d'éclairage x niveau	Kit extérieur laqué (Gondole + côtés)
EFILQ 1R	117 €	65 €	52 €	441 €
EFILQ 2R	156 €	81 €	75 €	456 €
EFILQ 3R	250 €	123 €	112 €	469 €

Características técnicas y constructivas sujetas a variación sin previo aviso. / We reserve the right to change specifications without prior notice. / Sujet technique et la conception de modifications sans préavis.



Laterales incluidos en PVP / Sides included in PVP / Latéraux inclus dans PVP

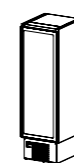

EFILQ 1R 4.501 €

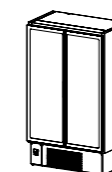

EFILQ 2R 5.905 €

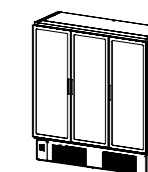

EFILQ 3R 7.386 €

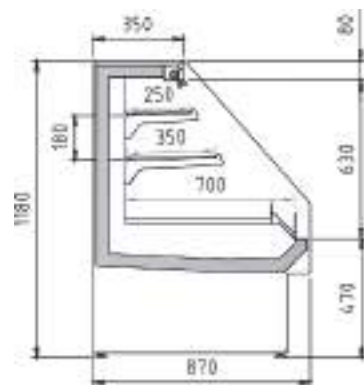

PPS

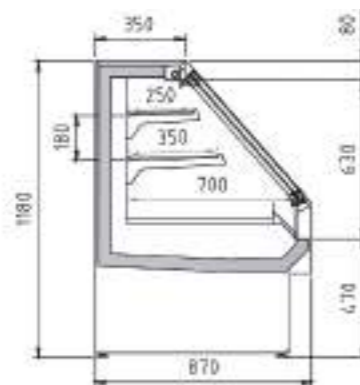

PPG

CARACTERÍSTICAS TÉCNICAS

- Mueble semivertical grupo incorporado de altura reducida para adaptarse a las características interiores del recinto.
- Modelo PPS: Cortina de noche manual y frente cuba inferior de metacrilato
- Modelo PPG: Puertas correderas de cristal doble
- Estándar interior en acero inoxidable
- Gran posibilidad de personalización. Estándar: base inferior en RAL 9005, franja superior e inferior en chapa a elegir de colores disponibles, costados panorámicos
- Evaporador ventilado pintado en EPOXI con recubrimiento anticorrosión
- Estantes en cristal templado, con portaprecios de 40 mm incluidos
- Desescarche natural del evaporador
- Bandeja de evaporación automática
- Ventiladores electromecánicos
- Control electrónico
- Iluminación LED 24v 4000k en visera
- Temperatura de producto, según EN-ISO-23953:
 - a. M1: -1°+5°C, apropiado para carnes.
 - b. M2: -1°+7°C, apropiado para lácteos, delis y embutidos
- Clase climática 3 (25°C, 60 H.R)

TECHNICAL DATA

- Plug in semivertical cabinet of reduced height ready to adapt to the interior features of the enclosure.
- PPS Model: Manual night blind and and inferior exposition deck perspex
- PPG Model: Double glass sliding doors
- Interior standard in stainless steel
- High customization possibilities. As standard: plinth in colour RAL 9005, inferior and superior decorative stripe choose from available colours, panoramic sides
- Ventilated evaporator EPOXY painted with anticorrosive coating
- Tempered glass shelves, with 40 mm price holders included
- Natural defrost of evaporator
- Automatic evaporation tray
- Electromechanic fans
- Electronic control
- 24v LED lighting on superior 4000k colour
- Product temperature, according to EN-ISO-23953:
 - a. M1: -1°+5°C, suitable for meat
 - b. M2: -1°+7°C, suitable for dairy products, delis and sausages
- Climatic class 3 (25°C, 60 H.R)

CARACTÉRISTIQUES TECHNIQUES

- Unité semi-verticale avec groupe intégré de hauteur réduite pour s'adapter aux caractéristiques intérieures de l'enceinte.
- Modèle PPS : store de nuit manuel et façade inférieure du réservoir en méthacrylate
- Modèle PPG : Portes coulissantes double vitrage
- Norme intérieure en acier inoxydable
- Grande possibilité de personnalisation. Standard : base inférieure en RAL 9005, bande supérieure et inférieure en tôle à choisir parmi les couleurs disponibles, côtés panoramiques
- Évaporateur ventilé peint en EPOXY avec revêtement anticorrosion.
- Etagères en verre trempé, avec porte-prix de 40 mm inclus.
- Dégivrage naturel de l'évaporateur
- Plateau d'évaporation automatique
- Ventilateurs électromécaniques
- Contrôle électronique
- Éclairage LED 24v 4000k sur la visière
- Température du produit, selon EN-ISO-23953 :
 - à. M1: -1° + 5°C, convient aux viandes.
 - b. M2: -1° + 7°C, convient aux produits laitiers, épicerie fines et saucisses
- Classe climatique 3 (25°C, 60 H.R.)

VITRINA MURAL SEMIVERTICAL GAMA AZALEA FONDO 891MM

PLUG-IN SEMI-VERTICAL MULTIDECK DISPLAY AZALEA RANGE 891MM · VITRINE MURALE SEMI-VERTICALE PROFONDEUR 891MM



PPS11354 25



Modelo	Longitud (con costados)	Área estantes refrigerados	Superficie total exposición	Volumen neto	Estantes	Potencia frigorífica	Consumo nominal	Refrigerante
Model	Length (with sides)	Refrigerated shelf area	Total display area	Net volume	Shelves	Cooling capacity	Nominal Power	Refrigerant
Modelé	Longueur (avec côtés)	Zone d'étagères réfrigérées	Surface totale d'exposition	Volume net	Étagères	Puissance frigorifique	Consommation nominale	Réfrigérant
	(mm)	m2	(TDA)	(L)	Uds.	(W)	(W)	
PPS / PPG11354 12	1310	1,55	1,07	210	2	1214	1674	R-290
PPS / PPG11354 18	1935	2,3	1,66	311	4	2056	2041	R-290
PPS / PPG11354 25	2560	3,05	2,21	414	4	2492	3091	R-290

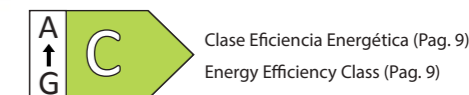

PVP de opcionales incluidos en equipo, no como repuesto / PVP of options included in the equipment, not as a spare part / PVP d'options incluses dans l'équipement, pas en tant que pièce de rechange
Interior epoxy negro sin incremento de precio / Black epoxy interior without price increase / Intérieur époxy noir sans majoration de prix

OPCIONES · OPTIONS · OPTIONS

Modelo	Decoración exterior lacado	Paragolpes tubo inox	Iluminación led extra x estante
Model	Lacquered exterior decoration	Stainless steel bumper	Led lighting extra x shelf
Modèle	Décoration extérieure laqué	Pare-chocs acier inoxydable	Éclairage led extra x étagéré
PPS / PPG11354 12	456 €	75 €	75 €
PPS / PPG11354 18	469 €	108 €	112 €
PPS / PPG11354 25	475 €	137 €	151 €

Laterales incluidos en PVP / Sides included in PVP / Latéraux inclus dans PVP

PPG11354 12 5.461 €	PPG11354 18 6.986 €	PPG11354 25 9.716 €
PPS11354 12 4.456 €	PPS11354 18 5.471 €	PPS11354 25 7.706 €

Características técnicas y constructivas sujetas a variación sin previo aviso. / We reserve the right to change specifications without prior notice. / Sujet technique et la conception de modifications sans préavis.

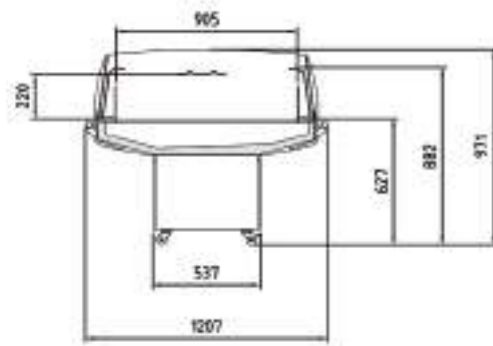

VIS-10-125

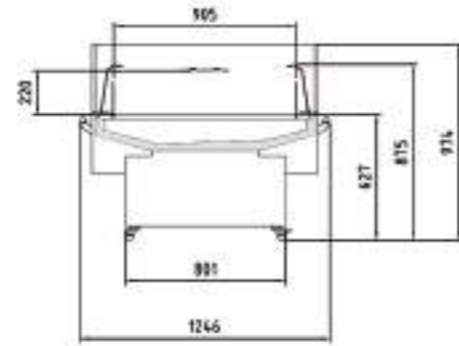

VISC-10-125



VISC-10-125



VIS-10-125

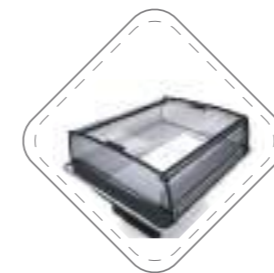

Puertas correderas
Slider doors

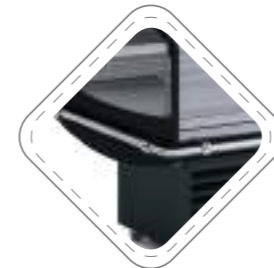

Paragolpes lateral opcional
Optional side bumper

CARACTERÍSTICAS TÉCNICAS VIS

- Mueble promocional enchufable con grupo incorporado con amplia capacidad de carga.
- Gran posibilidad de personalización. Estándar: zócalo inferior y franjas en RAL 9005.
- Lateral panorámico cristal doble templado securizado, modelo metacrilato opcional
- Frontal vidrio templado securizado.
- Tubo paragolpes en acero inoxidable (de serie sólo frontal y trasero).
- Evaporador ventilado HC pintado en EPOXI con recubrimiento anticorrosión
- Interior en chapa de acero inoxidable (estándar) o pintado en EPOXI negro (sin incremento)
- Desescarche natural del evaporador
- Condensación ventilada.
- Evaporación automática de desescarche.
- Ruedas de serie.
- Plano de exposición regulable en inclinación.
- Ventiladores electromecánicos
- Control electrónico
- Temperatura de producto, según EN-ISO-23953: M2: -1°+5°C.
- Clase climática 3 (25°C, 60 H.R)

COMMON TECHNICAL VIS

- Plug-in promotional island with wide visibility of the product
- High customization possibilities. As standard: plinth and decorative stripes in colour RAL 9005.
- Securized tempered double glass panoramic end panel, optional methacrylate model
- Securized tempered frontal glass.
- Stainless steel bumper tube (as standard only frontal and rear bumper).
- Ventilated HC evaporator EPOXY painted with anticorrosive coating.
- Interior in stainless steel sheet (standard) or Black EPOXY coating (same price).
- Natural defrost of evaporator.
- Ventilated condensation.
- Auto defrost evaporation.
- Wheels as standard
- Adjustable tilting in display area
- Electromechanic fans
- Electronic control
- Product temperature, according to EN-ISO-23953: M2: -1°+5°C.
- Climatic class 3 (25°C, 60 H.R)

CARACTÉRISTIQUES TECHNIQUES VIS

- Unité enfichable promotionnelle avec groupe intégré avec une grande capacité de charge.
- Grande possibilité de personnalisation. Standard: plinthe inférieure et bandes en RAL 9005.
- Verre de sécurité trempé double côté panoramique, modèle en méthacrylate en option
- Verre trempé de sécurité à l'avant.
- Tube de pare-chocs en acier inoxydable (de série uniquement à l'avant et à l'arrière).
- Évaporateur ventilé HC peint en EPOXY avec revêtement anti-corrosion
- Intérieur en tôle d'acier inoxydable (standard) ou peint en EPOXY noir (sans augmentation)
- Dégivrage naturel de l'évaporateur
- Condensation ventilée.
- Évaporation de dégivrage automatique.
- Roues standard.
- Plan d'exposition réglable en inclinaison.
- Ventilateurs électromécaniques
- Contrôle électronique
- Température du produit, selon EN-ISO-23953: M2: -1° + 5°C.
- Classe climatique 3 (25 ° C, 60 H.R)

Modelo	Largo x Alto x Fondo	Área estantes refrigerados	Superficie total exposición	Volumen neto	Potencia frigorífica	Refrigerante	Consumo nominal
Model	Length x Height x Depth	Refrigerated shelf area	Total display area	Net volume	Cooling capacity	Refrigerant	Nominal power
Modelé	Longueur x hauteur x profondeur	Zone d'étagères réfrigérées	Surface totale d'exposition	Volume net	Puissance frigorifique	Réfrigérant	Consommation nominale
	(mm)	m2	(TDA)	(L)	(W)	(HC)	(W)
VIS-10-125	1250x971x1207	1,05	1,31	230	949	R-290	1089
VISC-10-125	1253x974x1246	1,05	1,31	230	949	R-290	1089
VISC-10-125	1253x974x1246	1,05	1,31	230	949	R-290	1089

230v 60Hz / 115v 60Hz. consultar - consult - consulter

PVP de opcionales incluidos en equipo, no como repuesto / PVP of options included in the equipment, not as a spare part / PVP d'options incluses dans l'équipement, pas en tant que pièce de rechange
Interior epoxy negro sin incremento de precio / Black epoxy interior without price increase / Intérieur époxy noir sans majoration de prix

OPCIONES · OPTIONS · OPTIONS

Modelo	Interior lacado	Exterior lacado	Cortina nocturna	Paragolpes tubo inox (Lateral 1 extremo.)	Kit unión 2 vitrinas
Model	Inside lacquered	Outside lacquered	Night blind	Stainless steel bumper (One side)	Union kit 2 showcases
Modèle	Intérieur laqué	Extérieur laqué	Rideau de nuit	Pare-chocs en acier inoxydable (une cote)	Kit Union 2 vitrines
VIS-10-125	220 €	260 €	242 €	108 €	223 €
VISG-10-125	220 €	260 €	242 €	108 €	223 €
VISC-10-125	220 €	260 €	242 €	108 €	223 €

Características técnicas y constructivas sujetas a variación sin previo aviso. / We reserve the right to change specifications without prior notice. / Sujet technique et la conception de modifications sans préavis.

A
↑
G **D** Clase Eficiencia Energética (Pag. 9)
Energy Efficiency Class (Pag. 9)

Laterales incluidos en PVP / Sides included in PVP / Latéraux inclus dans PVP



VIS-10-125 **3.420 €**

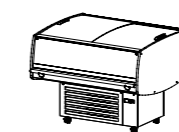

VISG-10-125 **3.920 €**



VISC-10-125 **3.420 €**

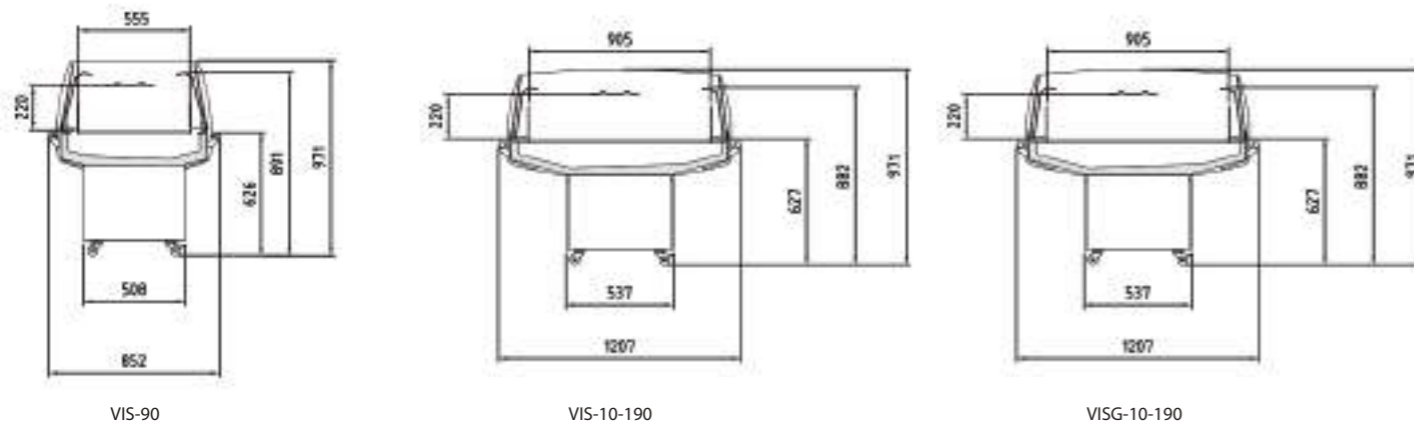

VIS-10-190



VIS-90

Puertas correderas
Slider doors

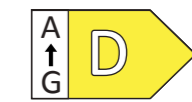
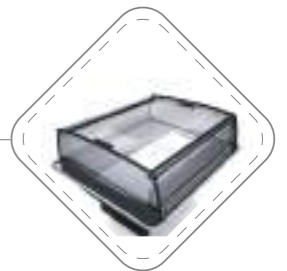

Clase Eficiencia Energética (Pag. 9)
Energy Efficiency Class (Pag. 9)

CARACTERÍSTICAS TÉCNICAS VIS	COMMON TECHNICAL VIS	CARACTÉRISTIQUES TECHNIQUES VIS
<ul style="list-style-type: none"> Mueble promocional enchufable con grupo incorporado con amplia capacidad de carga. Gran posibilidad de personalización. Estándar: zócalo inferior y franjas en RAL 9005. Lateral panorámico cristal doble templado securizado Frontal vidrio templado securizado. Tubo paragolpes en acero inoxidable (de serie sólo frontal y trasero). Evaporador ventilado HC pintado en EPOXI con recubrimiento anticorrosión Interior en chapa de acero inoxidable (estándar) o pintando en EPOXI negro (sin incremento) Desescarche natural del evaporador Condensación ventilada. Evaporación automática de desescarche. Ruedas de serie. Plano de exposición regulable en inclinación. Ventiladores electromecánicos Control electrónico Temperatura de producto, según EN-ISO-23953: M2: -1°+5°C. Clase climática 3 (25°C, 60 H.R) 	<ul style="list-style-type: none"> Plug-in promotional island with wide visibility of the product High customization possibilities. As standard: plinth and decorative stripes in colour RAL 9005. Securized tempered double glass panoramic end panel Securized tempered frontal glass. Stainless steel bumper tube (as standard only frontal and rear bumper). Ventilated HC evaporator EPOXY painted with anticorrosive coating. Interior in stainless steel sheet (standard) or Black EPOXY coating (same price). Natural defrost of evaporator. Ventilated condensation. Auto defrost evaporation. Wheels as standard Adjustable tilting in display area Electromechanic fans Electronic control Product temperature, according to EN-ISO-23953: M2: -1°+5°C. Climatic class 3 (25°C, 60 H.R) 	<ul style="list-style-type: none"> Unité enchâssable promotionnelle avec groupe intégré avec une grande capacité de charge. Grande possibilité de personnalisation. Standard: plinthe inférieure et bandes en RAL 9005. Verre de sécurité trempé double côté panoramique Verre trempé de sécurité à l'avant. Tube de pare-chocs en acier inoxydable (de série uniquement à l'avant et à l'arrière). Évaporateur ventilé HC peint en EPOXY avec revêtement anti-corrosion Intérieur en tôle d'acier inoxydable (standard) ou peint en EPOXY noir (sans augmentation) Dégivrage naturel de l'évaporateur Condensation ventilée. Évaporation de dégivrage automatique. Roues standard. Plan d'exposition réglable en inclinaison. Ventilateurs électromécaniques Contrôle électronique Température du produit, selon EN-ISO-23953: M2: -1° + 5°C. Classe climatique 3 (25 ° C, 60 H.R)

Modelo	Largo x Alto x Fondo	Área estantes refrigerados	Superficie total exposicion	Volumen neto	Potencia frigorífica	Refrigerante	Consumo nominal
Model	Length x Height x Depth	Refrigerated shelf area	Total display area	Net volume	Cooling capacity	Refrigerant	Nominal power
Modelé	Longueur x hauteur x profondeur	Zone d'étagères réfrigérées	Surface totale d'exposition	Volume net	Puissance frigorifique	Réfrigérant	Consommation nominale
	(mm)	m2	(TDA)	(L)	(W)	(HC)	(W)
VIS-90	900x971x852	0,48	0,67	105	572	R-290	882
VISG-90	900x971x852	0,48	0,67	105	572	R-290	882
VIS-10-190	1915x971x1207	1,62	2,03	356	1419	R-290	1356
VISG-10-190	1915x971x1207	1,62	2,03	356	1419	R-290	1356

230v 60Hz / 115v 60Hz. consultar - consult - consulter
 PVP de opcionales incluidos en equipo, no como repuesto / PVP of options included in the equipment, not as a spare part / PVP d'options incluses dans l'équipement, pas en tant que pièce de rechange
 Interior epoxy negro sin incremento de precio / Black epoxy interior without price increase / Intérieur époxy noir sans majoration de prix

OPCIONES · OPTIONS · OPTIONS						
Modelo	Interior lacado	Exterior lacado	Cortina nocturna	Kit puertas	Paragolpes tubo inox (Lateral 1 extremo.)	Kit unión 2 vitrinas
Model	Inside lacquered	Outside lacquered	Night blind	Doors kit	Stainless steel bumper (One side)	Union kit 2 showcases
Modèle	Intérieur laqué	Extérieur laqué	Rideau de nuit	Kit de porte	Pare-chocs en acier inoxydable (une cote)	Kit Union 2 vitrines
VIS-90	165 €	195 €	175 €	560 €	108 €	223 €
VISG-90	165 €	195 €	175 €	560 €	108 €	223 €
VISG-10-190	330 €	390 €	321 €	980 €	108 €	223 €
VIS-10-190	330 €	390 €	321 €	980 €	108 €	223 €

LATERALES INCLUIDOS EN PVP / SIDES INCLUDED IN PVP / LATÉRAUX INCLUS DANS PVP			
	VIS-90	2.999 €	
	VISG-90	3.330 €	
	VIS-10-190	5.421 €	
	VISG-10-190	6.321 €	

Características técnicas y constructivas sujetas a variación sin previo aviso. / We reserve the right to change specifications without prior notice. / Sujet technique et la conception de modifications sans préavis.

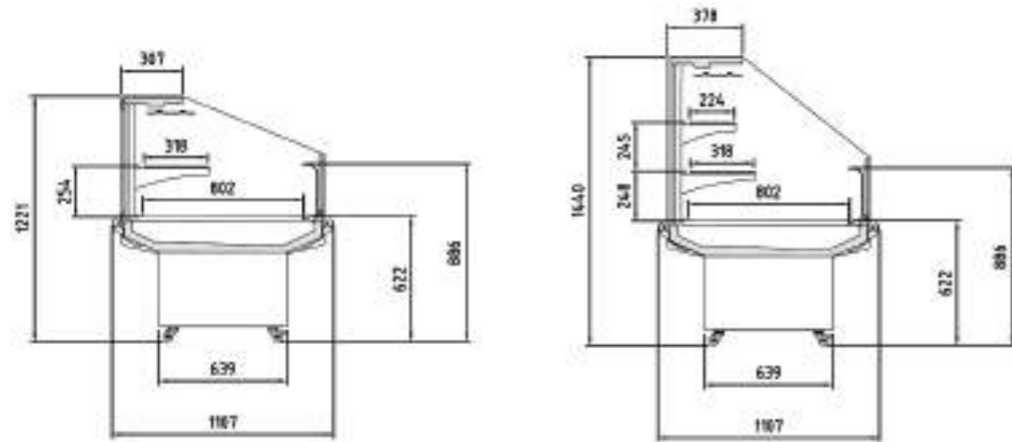

VIS-9-125-1E

VIS-9-125-2E

CARACTERÍSTICAS TÉCNICAS VIS

- Mueble promocional enchufable con grupo incorporado con amplia capacidad de carga.
- Gran posibilidad de personalización. Estándar: zócalo inferior y franjas en RAL 9005.
- Lateral panorámico cristal doble templado securizado.
- Frontal vidrio templado securizado.
- Trasera en doble cristal templado securizado.
- Estantes de cristal templado.
- Tubo paragolpes en acero inoxidable (de serie sólo frontal y trasero).
- Evaporador ventilado HC pintado en EPOXI con recubrimiento anticorrosión
- Interior en chapa de acero inoxidable (estándar) o pintando en EPOXI negro (sin incremento)
- Desescarche natural del evaporador
- Condensación ventilada.
- Evaporación automática de desescarche.
- Ruedas de serie.
- Ventiladores electromecánicos.
- Control electrónico.
- Temperatura de producto, según EN-ISO-23953: M2: -1°+7°C.
- Clase climática 3 (25°C, 60 H.R)

COMMON TECHNICAL VIS

- Plug-in promotional island with wide visibility of the product
- High customization possibilities. As standard: plinth and decorative stripes in colour RAL 9005.
- Securized tempered double glass panoramic end panel.
- Securized tempered frontal glass.
- Securized tempered double glass rear panel.
- Tempered glass shelves.
- Stainless steel bumper tube (as standard only frontal and rear bumper).
- Ventilated HC evaporator EPOXY painted with anticorrosive coating.
- Interior in stainless steel sheet (standard) or Black EPOXY coating (same price).
- Natural defrost of evaporator.
- Ventilated condensation.
- Auto defrost evaporation.
- Wheels as standard.
- Electromechanic fans.
- Electronic control.
- Product temperature, according to EN-ISO-23953: M2: -1°+7°C
- Climatic class 3 (25°C, 60 H.R)

CARACTÉRISTIQUES TECHNIQUES VIS

- Unité enchâssable promotionnelle avec groupe intégré avec une grande capacité de charge.
- Grande possibilité de personnalisation. Standard: plinthe inférieure et bandes en RAL 9005.
- Verre de sécurité trempé double côté panoramique.
- Verre trempé de sécurité avant.
- Fond en verre de sécurité double trempé.
- Étagères en verre trempé.
- Tube de pare-chocs en acier inoxydable (de série uniquement à l'avant et à l'arrière).
- Évaporateur ventilé HC peint en EPOXY avec revêtement anti-corrosion
- Intérieur en tôle d'acier inoxydable (standard) ou peinture en EPOXY noir (pas d'augmentation)
- Dégivrage naturel de l'évaporateur
- Condensation ventilée.
- Évaporation de dégivrage automatique.
- Roues standard.
- Ventilateurs électromécaniques.
- Contrôle électronique.
- Température du produit, selon EN-ISO-23953: M2: -1° + 7°C.
- Classe climatique 3 (25 ° C, 60 H.R)



VIS-9-125-1E



Paragolpes lateral opcional
Optional side bumper



VIS-9-125-2E

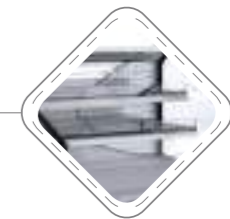

Tope estante metacrilato opcional
Optional methacrylate shelf stop



Clase Eficiencia Energética (Pag. 9)
Energy Efficiency Class (Pag. 9)

Modelo	Largo x Alto x Fondo	Área estantes refrigerados	Superficie total exposicion	Volumen neto	Estantes	Potencia frigorífica	Refrigerante	Consumo nominal
Model	Length x Height x Depth	Refrigerated shelf area	Total display area	Net volume	Shelves	Cooling capacity	Refrigerant	Nominal power
Modelé	Longueur x hauteur x profondeur	Zone d'étagères réfrigérées	Surface totale d'exposition	Volume net	Étagères	Puissance frigorifique	Réfrigérant	Consommation nominale
	(mm)	m2	(TDA)	(L)	(Uds.)	(W)	(HC)	(W)
VIS-9-125-1E	1250x1221x1107	1,28	1,2	304	1	1419	R-290	1316
VIS-9-125-2E	1250x1440x1107	1,7	1,36	405	2	1937	R-290	1666

230v 60Hz / 115v 60Hz. consultar - consult - consulter

PVP de opcionales incluidos en equipo, no como repuesto / PVP of options included in the equipment, not as a spare part / PVP d'options incluses dans l'équipement, pas en tant que pièce de rechange

OPCIONES - OPTIONS - OPTIONS

Modelo	Interior lacado	Exterior lacado	Kit cortina nocturna	Paragolpes tubo inox (Lateral 1 extremo.)	Kit unión 2 vitrinas
Model	Inside lacquered	Outside lacquered	Night blind kit	Stainless steel bumper (One side)	Union kit 2 showcases
Modèle	Intérieur laqué	Extérieur laqué	Rideau a nuit kit	Pare-chocs en acier inoxydable (une cote)	Kit Union 2 vitrines
VIS-9-125-1E	220 €	390 €	242 €	108 €	223 €
VIS-9-125-2E	220 €	520 €	242 €	108 €	223 €

Características técnicas y constructivas sujetas a variación sin previo aviso. / We reserve the right to change specifications whitout prior notice. / Sujet technique et la conception de modifications sans préavis.

Laterales incluidos en PVP / Sides included in PVP / Latéraux inclus dans PVP



VIS-9-125-1E **3.762 €**

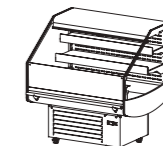

VIS-9-125-2E **4.287 €**

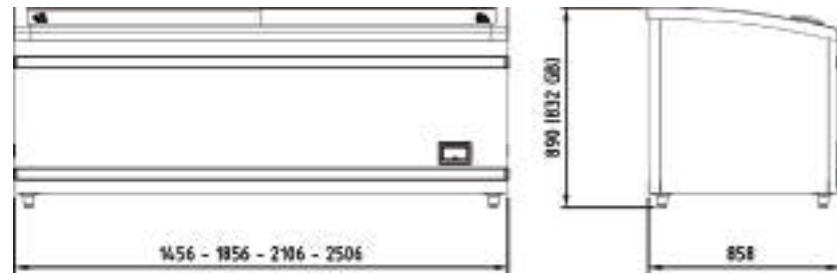

DUMD 1850 GB D/S DF



DUMD 2500 D/S DF

CONSERVADORES DE CONGELADOS

CARACTERÍSTICAS TÉCNICAS DUMD

- Exterior en chapa plastificada acero RAL 9005
- Perfilera, paragolpes y rejillas en color gris RAL 9006
- Interior en chapa plastificada acero RAL 9003
- Puertas correderas, en cristal templado con tratamiento refractario y bajo emisivo
- Iluminación estándar: LED interior de bajo consumo
- Canal de desagüe interior
- Sistema de divisores incluido en modelo estándar
- Aislamiento de poliuretano inyectado, bajo GWP y cero efecto ODP
- Evaporador impreso en el interior de la cámara
- Condensador helicoidal, libre de mantenimiento
- Descarche automático por gas caliente
- Control electrónico de temperatura
- Clase climática 3 (25°C 60% H.R.)
- Rango de funcionamiento -18°/-23°C o -1°/+5°C, temperatura de producto L1: -15°/-18°C o M1: -1°/+5°C
- Refrigerante R-290

FROZEN CONSERVATIVES

COMMON TECHNICAL DUMD

- Exterior in plasticized sheet steel RAL 9005
- Profiles, bumpers and grilles in gray RAL 9006.
- Interior in plasticized sheet steel RAL 9003
- Sliding doors, in tempered glass with refractory treatment and low emission.
- Standard lighting: low consumption interior LED
- Internal drainage channel
- Divider system included in standard model
- Injected polyurethane insulation, low GWP and zero ODP effect.
- Evaporator printed inside the chamber
- Helical condenser, maintenance free
- Automatic hot gas defrost
- Electronic temperature control
- Climatic class 3 (25°C 60% R.H.)
- Operating range -18°/-23°C or -1°/+5°C, product temperature L1: -15°/-18°C or M1: -1°/+5°C
- R-290 refrigerant

CONSERVATEURS CONGELÉS

CARACTÉRISTIQUES TECHNIQUES DUMD

- Extérieur en tôle d'acier plastifiée RAL 9005
- Profils, pare-chocs et grilles en gris RAL 9006.
- Intérieur en tôle d'acier plastifiée RAL 9003
- Portes coulissantes, en verre trempé avec traitement réfractaire et à faible émission.
- Éclairage standard : LED intérieure basse consommation
- Canal de drainage interne
- Système de diviseur inclus dans le modèle standard
- Isolation en polyuréthane injecté, faible GWP et zéro effet ODP.
- Évaporateur imprimé à l'intérieur de la chambre
- Condenseur hélicoïdal, sans entretien
- Dégivrage automatique par gaz chaud
- Contrôle électronique de la température
- Classe climatique 3 (25°C 60% H.R.)
- Plage de fonctionnement -18°/-23°C ou -1°/+5°C, température du produit L1 : -15°/-18°C ou M1: -1°/+5°C
- Réfrigérant R-290

Modelo Model Modèle	Largo Length Longueur (mm)	Alto Height Hauteur (mm)	Fondo Depth Profondeur (mm)	Largo int. Int. Length Longueur int. (mm)	Alto int. Int. Height Hauteur int. (mm)	Fondo int. Int. Depth Profondeur int. (mm)	Capacidad útil New capacity Capacité utile (L)	Ecoetiquetado Ecolabelling Écoétiquetage	Consumo Consumption Consommation (W)
DUMD 1450 D/S DF	1456	890	858	1320	627 / 685	720	588	C	5,06 kWh/24h
DUMD 1850 GB D/S DF	1856	832	858	1720	627 / 685	720	713	D	6,65 kWh/24h
DUMD 2100 D/S DF	2106	890	858	1970	627 / 685	720	905	C	7,18 kWh / 24h
DUMD 2500 D/S DF	2506	890	858	2370	627 / 685	720	1100	C	8,22 kWh/24h

Lista de accesorios: Consultar / Accessories list: Consult / Liste des accessoires : Consulter

Características técnicas y constructivas sujetas a variación sin previo aviso. / We reserve the right to change specifications without prior notice. / Sujet technique et la conception de modifications sans préavis.

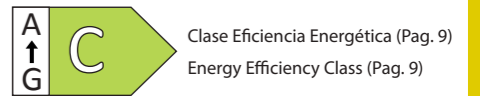

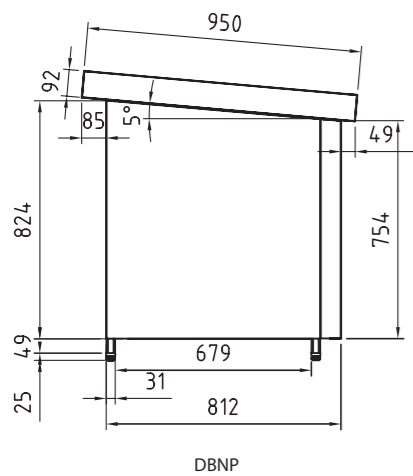

DBNP-220

CARACTERÍSTICAS TÉCNICAS

- Bandeja de exposición de acero inoxidable austenítico AISI 304 que evita la corrosión, incluso en ambientes más agresivos.
- Chasis construido con tubo de acero inoxidable.
- Facilidad de limpieza total: Compartimento de equipo frigorífico hermético que permite la limpieza exterior del mueble con chorro de agua directo.
- Control electrónico de temperatura
- Espesor lateral costados: 40+40 mm
- Aislamiento de poliuretano inyectado, densidad 40 Kg/m³, bajo GWP y cero efecto ODP
- DBFP-S: Pre-instalación, unidad condensadora incluida
- DBNP, DBNP-S: neutro, sin frío.
- Recomendación: Canalización de agua de desescarche desde desagüe hasta acometida de aguas.

TECHNICAL DATA

- Tray exhibition AISI 304 austenitic stainless steel to prevent corrosion, even in the toughest environments.
- Chassis built with stainless steel tube.
- Easy cleanup: hermetic refrigeration equipment compartment which allows the external cleaning of the unit with direct water stream.
- Electronic temperature controller
- Lateral sides Thickness: 40 +40 mm
- Aislamiento de poliuretano inyectado, densidad 40 Kg/m³, bajo GWP y cero efecto ODP
- DBFP-S: Ready for remote compressor, condenser unit included
- DBNP, DBNP-S: neutral, without cooling system.
- Recommendation: Channeling defrost water from draining until water supplying.

CARACTÉRISTIQUES TECHNIQUES

- Plateau d'exposition en acier inoxydable aux normes AISI 304, évitant la corrosion, même en environnement agressif.
- Chassis construit sur un tube en acier inoxydable.
- Facilités de nettoyage total: Les compartiments de l'équipement frigorifique sont hermétiques, permettant ainsi le nettoyage extérieur du meuble au jet d'eau.
- Contrôle électronique de température
- Épaisseur latérale des côtés: 40 + 40mm
- Isolation à base de polyuréthane injecté, densité 40 kg / m³, faible GWP et aucun effet ODP.
- DBFP-S: Pré-installation, unité condensatrice inclus
- DBNP, DBNP-S: neutre, sans froid
- Recommendation: Canalisation de l'eau de dégivrage de la vidange jusqu'au receptrer d'eau.

Modelo	Longitud (con costados)	Alto	Fondo	Potencia frigorífica	Consumo nominal	Área estantes refrigerados m2	Tensión monofásica	Refrigerante HFC / HC	Rango
Model	Length (with sides)	Height	Depth	Cooling capacity	Nominal Power	Refrigerated shelf area m2	Single phase voltage	Refrigerant HFC /HC	Range
Modelé	Longueur (avec côtés)	Hauteur	Profondeur	Puissance frigorifique	Consommation nominale	Zone d'étagères réfrigérées	Tension monophasique	Réfrigérant HFC /HC	Range
	(mm)	(mm)	(mm)	(W)	(W)		(W)		(m ²)
DBFP-120	1200	1000 / 925	950	414	208	0,96	230V - 50 Hz	R-134a	0°C + 2 °C
DBFP-170	1700	1000 / 925	950	698	350	1,40	230V - 50 Hz	R-134a	0°C + 2 °C
DBFP-220	2200	1000 / 925	950	912	530	1,84	230V - 50 Hz	R-449A	0°C + 2 °C
DBFP-270	2700	1000 / 925	950	1353	679	2,30	230V - 50 Hz	R-449A	0°C + 2 °C
DBFP-120-S	1200	95	950	414	208	0,96	230V - 50 Hz	R-134a	0°C + 2 °C
DBFP-170-S	1700	95	950	698	350	1,40	230V - 50 Hz	R-134a	0°C + 2 °C
DBFP-220-S	2200	95	950	912	530	1,84	230V - 50 Hz	R-449A	0°C + 2 °C
DBFP-270-S	2700	95	950	1353	679	2,30	230V - 50 Hz	R-449A	0°C + 2 °C

PVP de opcionales incluidos en equipo, no como repuesto / PVP of options included in the equipment, not as a spare part / PVP d'options incluses dans l'équipement, pas en tant que pièce de rechange

OPCIONES · OPTIONS · OPTIONS		DBFP-120	DBFP-170	DBFP-220	DBFP-270	
Perímetro acristalado	Perimeter glass	Périmètre de vitage	160 €	190 €	210 €	240 €
Largos especiales	Customized lengths	Spécial long	consultar - consult - consulter			
230v 60Hz / 115v 60Hz			consultar - consult - consulter			

Características técnicas y constructivas sujetas a variación sin previo aviso. / We reserve the right to change specifications without prior notice. / Sujet technique et la conception de modifications sans préavis.



DBFP-120
Perímetro acristalado opcional
Optional perimeter glass
Option périmètre vitrage



DBNP-120
Modelo neutro
Neutral model
Modèle neutrale

DBFP-120 2.882 €	DBFP-170 3.238 €	DBFP-220 3.552 €	DBFP-270 3.981 €
DBNP-120 1.683 €	DBNP-170 1.931 €	DBNP-220 2.187 €	DBNP-270 2.453 €

CARACTERÍSTICAS TÉCNICAS	TECHNICAL DATA	CARACTÉRISTIQUES TECHNIQUES
<ul style="list-style-type: none"> Refrigerante R-449A o R-134a, o refrigerantes alternativos. Compresor hermético alternativo, montado sobre amortiguadores, con silenciador de descarga y clixon interno. Batería condensadora de alta eficiencia de tubos de cobre y aletas de aluminio. Turbina centrífuga con presión estática disponible para la conducción del aire de condensación (versión centrífuga). Circuito frigorífico equipado con presostatos de alta y baja presión, filtro cerámico, recipiente y visor de líquido. Control digital de presión de condensación con el opcional de controlador electrónico, y control de condensación todo / nada en condensadoras sin cuadro eléctrico. Control proporcional de presión de condensación mediante variación de velocidad del motoventilador (incluido a partir de MDH serie 4). Cuadro eléctrico de potencia y maniobra, con protección de compresor y motoventilador. Centralita electrónica de control del evaporador (en versiones -N). Separador de aceite integrado (en versiones multiservicio -V). Inyección de líquido en modelos de baja temperatura con R-449A. Gas refrigerante no incluido Versiones -N: Sin controlador electrónico: diseñada para el control de paro / marcha por baja presión (caída por baja o pump down). 	<ul style="list-style-type: none"> R-449A or R-134a refrigerant, or alternative refrigerants. Hermetic reciprocating compressor, mounted on shock absorbers, with discharge silencer and internal clixon. High efficiency condensing coil made of copper tubes and aluminum fins. Centrifugal turbine with static pressure available for conducting condensation air (centrifugal version). Refrigeration circuit equipped with high and low pressure switches, ceramic filter, container and liquid sight glass. Digital control of condensation pressure with the optional electronic controller, and on / off condensation control in condensers without electrical panel. Proportional control of condensation pressure by varying the fan speed (included from MDH series 4). Power and maneuvering electrical panel, with compressor and fan motor protection. Electronic evaporator control unit (-N versions). Integrated oil separator (in multi-service -V versions). Liquid injection in low temperature models with R-449A. Refrigerant gas not included N versions: Without electronic controller: designed for the control of stop / start due to low pressure (drop due to low or pump down). 	<ul style="list-style-type: none"> Réfrigérant R-449A ou R-134a, ou autres réfrigérants. Compresseur hermétique à piston, monté sur amortisseurs, avec silencieux de refoulement et clixon interne. Batterie de condensation à haut rendement en tubes de cuivre et ailettes en aluminium. Turbine centrifuge à pression statique disponible pour conduire l'air de condensation (version centrifuge). Circuit frigorifique équipé de pressostats haute et basse pression, filtre céramique, récipient et voyant de liquide. Contrôle numérique de la pression de condensation avec le contrôleur électronique en option et contrôle marche / arrêt de la condensation dans les condenseurs sans panneau électrique. Contrôle proportionnel de la pression de condensation en faisant varier la vitesse du ventilateur (inclus à partir de la série MDH 4). Tableau électrique de puissance et de manœuvre, avec protection du compresseur et du moteur du ventilateur. Unité de contrôle électronique de l'évaporateur (versions -N). Séparateur d'huile intégré (dans les versions multiservices -V). Injection de liquide dans les modèles basse température avec R-449A. Gaz réfrigérant non inclus -N versions: Sans contrôleur électronique: conçu pour le contrôle dearrêt / démarrage en raison d'une basse pression (chute due à une basse ou à un pompage). Avec contrôleur électronique: il intègre le contrôleur électronique avancé XM670K pour la gestion du groupe de condensation et de l'évaporateur, il permet d'intégrer en option l'électrovanne.

Con controlador electrónico: incorpora el avanzado controlador electrónico XM670K para la gestión de la unidad condensadora y del evaporador, permite integrar opcionalmente la válvula solenoide.

With electronic controller: it incorporates the advanced electronic controller XM670K for the management of the condensing unit and the evaporator, it allows to optionally integrate the solenoid valve.

Esquema frigorífico DH - Centrífuga

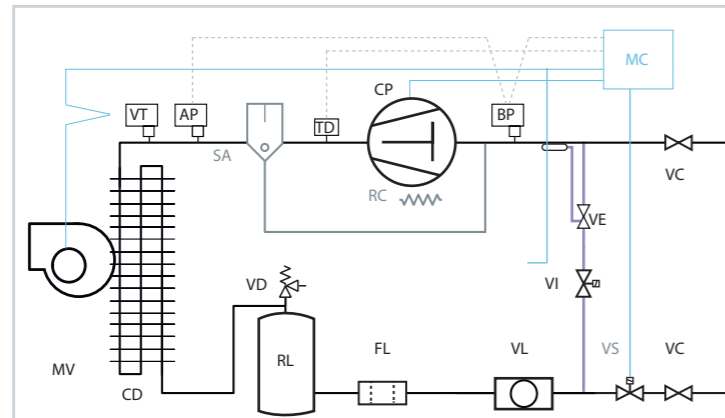

- EQUIPAMIENTO BÁSICO
- CD: CONDENSADOR
 - CP: COMPRESOR
 - FL: FILTRO
 - MV: MOTOVENTILADOR
 - RL: RECIPIENTE DE LÍQUIDO
 - VL: VISOR DE LÍQUIDO
 - VC: VÁLVULA SERVICIO DE 3 VÍAS (hasta conexiones 3/4")
 - VD: VÁLVULA DE SEGURIDAD
- EQUIPAMIENTO OPCIONAL
- RC: RESISTENCIA DE CÁRTER
 - SA: SEPARADOR DE ACEITE
 - VS: VÁLVULA SOLENOIDE
- SISTEMA DE INYECCIÓN DE LÍQUIDO (SOLO BDH)
- TD: TERMOSTATO DE DESCARGA
 - VE: VÁLVULA DE EXPANSIÓN
 - VI: VÁLVULA SOLENOIDE DE LÍQUIDO

EQUIPAMIENTO ADICIONAL VERSIÓN -N CON CONTROLADOR ELECTRÓNICO (MDH-C Y BDH-C)
MC: MICROCONTROLADOR ELECTRÓNICO



OPCIONES	OPTIONS	OPTIONS
Cambio a alimentación 400 V-III-50 Hz. + 8 %	Change to power supply 400 V-III-50 Hz. + 8 %	Passage à l'alimentation 400 V-III-50 Hz. + 8 %
Control de condensación proporcional por variación de velocidad (serie 1,2 y 3). + 250 €	Proportional condensation control by variation of speed (series 1,2 and 3). + 250 €	Contrôle proportionnel de la condensation par variation de vitesse (séries 1, 2 et 3). + 250 €
Separador de aceite (ya incluido en versiones -V). + 590 €	Oil separator (already included in -V versions). + 590 €	Séparateur d'huile (déjà inclus dans les versions -V). + 590 €
Resistencia de cárter. + 60 €	Crankcase heater. + 60 €	Réchauffeur de carter. + 60 €
Válvula solenoide integrada con cuerpo y bobina (excepto versiones -V). + 145 €	Integrated solenoid valve with body and coil (except -V versions). + 145 €	Electrovanne intégrée avec corps et bobine (sauf versions -V). + 145 €
Recubrimiento anticorrosión de batería. + 8 %	Battery anti-corrosion coating. + 8 %	Revêtement anti-corrosion de la batterie. + 8 %
Compuerta de descarga antirretorno (equipos centrífugos). + 25 €	Non-return discharge gate (centrifugal equipment). + 25 €	Porte de décharge anti-retour (équipement centrifuge). + 25 €
Adaptación de impulsión de aire a conducto circular. + 100 €	Adaptation of air supply to circular duct. + 100 €	Adaptation de l'alimentation en air au conduit circulaire. + 100 €
Impulsión vertical (equipos centrífugos). + 5 %	Vertical drive (centrifugal equipment). + 5 %	Entraînement vertical (équipement centrifuge). + 5 %
Cuadro eléctrico y centralita electrónica para el control de la unidad condensadora y el evaporador. + 150 €	Electrical panel and electronic control unit for the	Tableau électrique et unité de commande électronique pour le

230 V-I-50 Hz / 400 V-III-50 Hz | Media temp. | Compresor hermético | R-134a / R-449A

Versión axial	Compresor		Potencia frigorífica EN13215 (W) (1) T° evap. -10 °C	Potencia frigorífica (W) (2) Temperatura de evaporación				Potencia absorb. nominal (kW)	Intens. máxima absorb. (A)	Conexión frigorífica Liq - Gas	Peso (kg)	Nivel presión sonora dB(A) (4)	PVP versión NY / NG (€)	Versión centrífuga					
	Serie / Modelo	CV		Tensión	0 °C	-5 °C	-10 °C							-15 °C	Serie / Modelo	Caudal (m³/h)	P.E.D. (mmca) (3)	PVP versión CY / CG (€)	
R-134a	MDH-NY-0 010	3/8	230 V-I	590	880	710	560	430	0,37	(1,54)	4,0	1/4"-3/8"	37	23	1.553 €	MDH-CY-0 010	375	8	1.779 €
	MDH-NY-0 015	1/2	230 V-I	830	1 210	980	780	600	0,51	(1,58)	5,0	1/4"-3/8"	40	30	1.706 €	MDH-CY-0 015	375	8	2.007 €
	MDH-NY-1 015	1/2	230 V-I	870	1 290	1 040	820	625	0,50	(1,69)	5,0	1/4"-1/2"	41	30	1.777 €	MDH-CY-1 015	575	8	2.141 €
	MDH-NY-1 026	3/4	230 V-I	1 270	1 890	1 520	1 190	920	0,72	(1,72)	9,0	1/4"-1/2"	48	26	2.118 €	MDH-CY-1 026	575	8	2.288 €
	MDH-NY-1 033	1	230 V-I	1 630	2 310	1 880	1 500	1 170	0,84	(1,87)	9,0	1/4"-1/2"	50	31	2.180 €	MDH-CY-1 033	575	8	2.695 €
	MDH-NY-2 053	1 1/2	230 V-I *	2 250	3 470	2 760	2 120	1 560	1,25	(1,77)	12,0	1/4"-5/8"	63	37	2.776 €	MDH-CY-2 053	1 000	12	3.280 €
	MDH-NY-3 074	2	230 V-I *	3 410	5 080	4 080	3 180	2 390	1,61	(2,06)	16,0	1/4"-3/4"	84	44	3.402 €	MDH-CY-3 074	1 500	14	3.747 €
	MDH-NY-4 086	4	400 V-III	4 310	6 620	5 240	4 040	3 040	1,97	(2,13)	14,0	3/8"-7/8"	107	48	4.055 €	MDH-CY-4 086	3 500	10	5.138 €
	MDH-NY-4 108	5	400 V-III	5 260	7 920	6 350	4 910	3 690	2,39	(2,88)	17,0	3/8"-7/8"	109	45	4.526 €	MDH-CY-4 108	3 500	10	5.607 €
	MDH-NY-4 136	6 1/2	400 V-III	6 700	9 570	7 810	6 210	4 730	3,24	2,59	20,0	3/8"-1 1/8"	112	44	4.948 €	MDH-CY-4 136	3 500	10	6.033 €
R-449A	MDH-NG-0 008	1/3	230 V-I	620	990	810	650	510	0,42	(1,53)	4,0	1/4"-3/8"	46	28	1.435 €	MDH-CG-0 008	375	8	1.636 €
	MDH-NG-0 010	3/8	230 V-I	800	1 250	1 030	830	660	0,52	(1,57)	5,0	1/4"-3/8"	46	33	1.480 €	MDH-CG-0 010	375	8	1.816 €
	MDH-NG-0 012	1/2	230 V-I	950	1 435	1 190	980	780	0,60	(1,61)	6,0	1/4"-3/8"	46	33	1.550 €	MDH-CG-0 012	375	8	1.941 €
	MDH-NG-1 014	1/2	230 V-I	1 150	1 770	1 460	1 190	950	0,69	(1,69)	6,0	1/4"-1/2"	50	33	1.686 €	MDH-CG-1 014	575	8	2.018 €
	MDH-NG-1 016	5/8	230 V-I	1 290	2 020	1 660	1 340	1 040	0,78	(1,71)	7,0	1/4"-1/2"	60	33	1.874 €	MDH-CG-1 016	575	8	2.156 €
	MDH-NG-1 018	3/4	230 V-I	1 560	2 360	1 960	1 600	1 270	0,94	(1,72)	8,0	1/4"-1/2"	60	33	1.970 €	MDH-CG-1 018	575	8	2.366 €
	MDH-NG-2 024	1	230 V-I	2 070	3 270	2 680	2 150	1 680	1,10	(1,93)	12,0	3/8"-5/8"	60	33	2.162 €	MDH-CG-2 024	1 000	12	2.713 €
	MDH-NG-2 026	1 1/4	230 V-I *	2 300	3 550	2 930	2 370	1 870	1,24	(1,91)	13,0	3/8"-5/8"	61	34	2.196 €	MDH-CG-2 026	1 000	12	2.922 €
	MDH-NG-2 034	1 1/2	230 V-I *	2 870	4 300	3 590	2 920	2 310	1,73	(1,71)	16,0	3/8"-5/8"	61	36	2.260 €	MDH-CG-2 034	1 000	12	3.059 €
	MDH-NG-3 038	1 3/4	400 V-III	3 270	4 970	4 100	3 310	2 610	1,56	(2,12)	6,0	3/8"-5/8"	78	39	2.855 €	MDH-CG-3 038	1 500	14	3.939 €
MDH-NG-4 048	2	400 V-III	4 330	6 850	5 580	4 460	3 490	2,14	(2,08)	13,0	3/8"-3/4"	95	36	3.492 €	MDH-CG-4 048	3 500	10	4.573 €	
MDH-NG-4 054	2 1/2	400 V-III	4 970	7 660	6 300	5 070	4 010	2,38	2,14	14,0	3/8"-3/4"	96	36	3.906 €	MDH-CG-4 054	3 500	10	4.990 €	
MDH-NG-4 060	3	400 V-III	5 720	8 590	7 130	5 800	4 620	2,84	2,98	15,0	3/8"-3/4"	97	35	4.388 €	MDH-CG-4 060	3 500	10	5.546 €	
MDH-NG-4 068	3 1/2	400 V-III	6 450	9 490	7 920	6 500	5 210	3,26	2,87	15,0	1/2"-3/4"	98	35	4.517 €	MDH-CG-4 068	3 500	10	6.171 €	

Dimensiones Intarbox DH - Axial

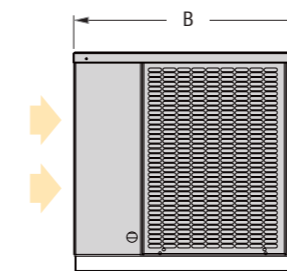

Dimensiones Intarbox DH - Centrífuga

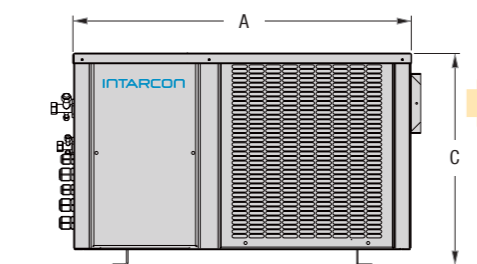
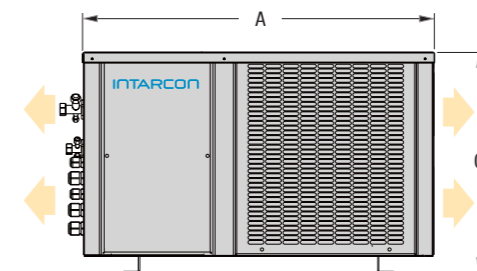
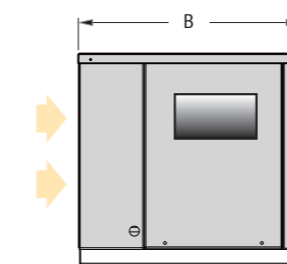

Dimensiones (mm)	A	B	C
serie 0	600	395	355
serie 1	665	435	416
serie 2	835	435	500
serie 3	925	580	515
serie 4	1 000	615	585
serie 5	1 290	755	656

Dimensiones (mm)	A	B	C	Embocadura turbina
serie 0	600	395	355	185 x 115
serie 1	665	435	416	185 x 115
serie 2	835	435	500	230 x 130
serie 3	925	580	515	236 x 266
serie 4	1 000	615	585	305 x 266
serie 5	1 290	755	656	305 x 266

CARACTERÍSTICAS TÉCNICAS	TECHNICAL DATA	CARACTÉRISTIQUES TECHNIQUES
<ul style="list-style-type: none"> Refrigerante R-449A o R-134a, o refrigerantes alternativos. Compresor hermético alternativo, montado sobre amortiguadores, con silenciador de descarga, resistencia de cárter y clixon interno. Batería condensadora de amplia superficie, de tubos de cobre y aletas de aluminio, con dimensionamiento tropicalizado para temperatura ambiente de hasta 50 °C. Motoventilador axial de bajas revoluciones. Circuito frigorífico equipado con presostatos de alta y baja presión, filtro cerámico, recipiente y visor de líquido. Control digital de presión de condensación con el opcional de controlador electrónico, y control de condensación todo / nada en condensadoras sin cuadro eléctrico. Control proporcional de presión de condensación mediante variación de velocidad del motoventilador (incluido a partir de MDF-NY-2086 y MDF-NG-1038 sin controlador electrónico). Cuadro eléctrico de potencia y maniobra, con protección de compresor y motoventilador. Centralita electrónica de control del evaporador (en versiones -N). Separador de aceite integrado (en versiones multiservicio -V). Gas refrigerante no incluido <p>Versiones -N: Sin controlador electrónico: diseñada para el control de paro / marcha por baja presión (caída por baja o pump down).</p> <p>Con controlador electrónico: incorpora el avanzado controlador electrónico XM670K para la gestión de la unidad condensadora y del evaporador, permite integrar opcionalmente la válvula solenoide.</p>	<ul style="list-style-type: none"> R-449A or R-134a refrigerant, or alternative refrigerants. Hermetic reciprocating compressor, mounted on shock absorbers, with discharge silencer, crankcase heater and internal clixon. Large surface condensing coil, made of copper tubes and aluminum fins, with tropicalized sizing for ambient temperatures up to 50 °C. Low speed axial motor fan. Refrigerating circuit equipped with high and low pressure switches, ceramic filter, container and liquid sight glass. Digital control of condensation pressure with the optional electronic controller, and on / off condensation control in condensers without electrical panel. Proportional control of condensing pressure by varying the fan speed (included from MDF-NY-2086 and MDF-NG-1038 without electronic controller). Power and maneuvering electrical panel, with compressor and motor fan protection. Electronic evaporator control unit (-N versions). Integrated oil separator (in multi-service versions -V). Gas refrigerant not included N versions: Without electronic controller: designed for the control of stop / start due to low pressure (drop due to low or pump down). <p>With electronic controller: it incorporates the advanced electronic controller XM670K for the management of the condensing unit and the evaporator, it allows to optionally integrate the solenoid valve.</p>	<ul style="list-style-type: none"> Réfrigérant R-449A ou R-134a, ou autres réfrigérants. Compresseur hermétique à piston, monté sur amortisseurs, avec silencieux de refoulement, résistance de carter et clixon interne. Batterie de condensation de grande surface, constituée de tubes en cuivre et d'ailettes en aluminium, avec dimensionnement tropicalisé pour des températures ambiantes jusqu'à 50 °C. Ventilateur à moteur axial à basse vitesse. Circuit frigorifique équipé de pressostats haute et basse pression, filtre céramique, récipient et voyant de liquide. Contrôle numérique de la pression de condensation avec le contrôleur électronique en option et contrôle marche / arrêt de la condensation dans les condenseurs sans panneau électrique. Contrôle proportionnel de la pression de condensation en faisant varier la vitesse du ventilateur (inclus à partir de MDF-NY-2086 et MDF-NG-1038 sans contrôleur électronique). Tableau électrique de puissance et de manœuvre, avec protection du compresseur et du moteur du ventilateur. Unité de contrôle électronique de l'évaporateur (versions -N). Séparateur d'huile intégré (dans les versions multiservices -V) Gaz réfrigérant non inclus N versions: Sans contrôleur électronique: conçu pour le contrôle de arrêt / démarrage en raison d'une basse pression (chute due à une basse ou à un pompage). Avec contrôleur électronique: il intègre le contrôleur électronique avancé XM670K pour la gestion du groupe de condensation et de l'évaporateur, il permet d'intégrer en option l'électrovanne.

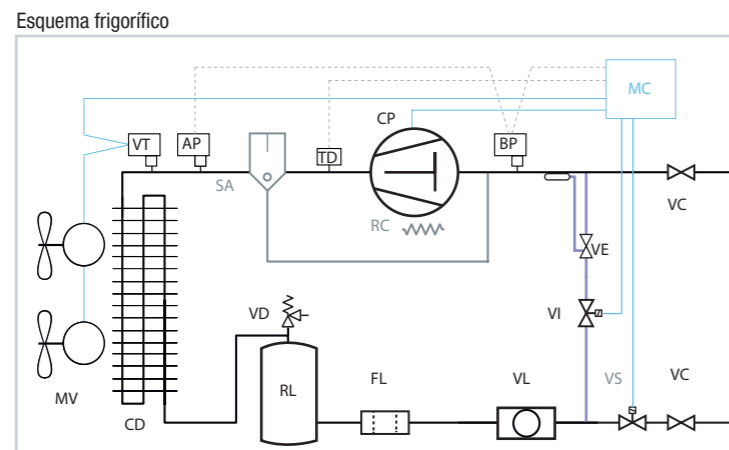

- EQUIPAMIENTO BÁSICO
- AP: PRESOSTATO DE ALTA PRESIÓN
 - BP: PRESOSTATO DE BAJA PRESIÓN
 - CD: CONDENSADOR
 - CP: COMPRESOR
 - FC: FILTRO
 - MV: MOTOVENTILADOR
 - RL: RECIPIENTE DE LÍQUIDO
 - RC: RESISTENCIA DE CÁRTER
 - VC: VÁLVULA DE SERVICIO
 - VD: VÁLVULA DE SEGURIDAD (a partir de 1 CV de potencia)
 - VL: VISOR DE LÍQUIDO
 - VT: VARIADOR DE TENSIÓN

EQUIPAMIENTO ADICIONAL DE LA VERSIÓN -N CON CONTROLADOR ELECTRÓNICO
 MC: MICROCONTROLADOR ELECTRÓNICO

- EQUIPAMIENTO OPCIONAL
- SA: SEPARADOR DE ACEITE
 - VS: VÁLVULA SOLENOIDE
- SISTEMA DE INYECCIÓN DE LÍQUIDO (SOLO BDF)
- TD: TERMOSTATO DE DESCARGA
 - VE: VÁLVULA DE EXPANSIÓN
 - VI: VÁLVULA SOLENOIDE DE LÍQUIDO

OPCIONES	OPTIONS	OPTIONS
Cambio a alimentación 400 V-III-50 Hz. + 8 %	Change to power supply 400 V-III-50 Hz. + 8 %	Passage à l'alimentation 400 V-III-50 Hz. + 8 %
Separador de aceite (ya incluido en version -V). + 590 €	Oil separator (already included in -V version). + 590 €	Séparateur d'huile (déjà inclus dans la version -V). + 590 €
Válvula solenoide integrada con cuerpo y bobina (excepto versiones -V). + 145 €	Integrated solenoid valve with body and coil (except -V versions). + 145 €	Electrovanne intégrée avec corps et bobine (sauf versions -V). + 145 €
Recubrimiento anticorrosión de batería. + 8 %	Battery anti-corrosion coating. + 8 %	Revêtement anti-corrosion de la batterie. + 8 %
Rejilla exterior de protección de batería. + 90 €	External battery protection grid. + 90 €	Grille de protection de batterie externe. + 90 €
Control de condensación proporcional por variación de velocidad del motoventilador (modelos desde 1015 hasta 1074 con R-134a, y modelos desde 1014 hasta 1034 en MT, y desde 1026 hasta 1074 en BT con R-449A). + 250 €	Proportional condensation control by variation fan speed (models from 1015 to 1074 with R-134a, and models from 1014 to 1034 in MT, and from 1026 to 1074 in LV with R-449A). + 250 €	Contrôle proportionnel de la condensation par variation vitesse du ventilateur (modèles de 1015 à 1074 avec R-134a et modèles de 1014 à 1034 en MT, et de 1026 à 1074 en LV avec R-449A). + 250 €
Cuadro eléctrico y centralita electrónica para el control de la unidad condensadora y el evaporador. + 5 %	Electrical panel and electronic control unit for the control of the condensing unit and evaporator. + 5 %	Tableau électrique et unité de commande électronique pour le contrôle de l'unité de condensation et de l'évaporateur. + 5 %
Mando multifunción de mayor tamaño. + 150 €	Larger multifunction control. + 150 €	Commande multifonction plus grande. + 150 €

230 V-I-50 Hz / 400 V-III-50 Hz | Media temp. | Condensadoras Silenciosas | Comp. hermético | R-134a / R-449A

Serie / Modelo	Compresor		Potencia frigorífica EN13215 (W) (1)	Potencia frigorífica (W) (2)				Potencia absorb. nominal (kW)	(C.O.P.) S.E.P.R. (3)	Intens. máxima absorb. (A)	Ventilador ø mm	Caudal (m³/h)	Conexión frigorífica Liq - Gas	Peso (kg)	Nivel presión sonora dB(A) (4)	PVP versión NY / NG (€)	
	CV	Tensión		0 °C	-5 °C	-10 °C	-15 °C										
R-134a	MDF-NY-0 010	3/8	230 V-I	590	870	700	560	430	0,33	(1,75)	4,0	Ø 200	350	1/4"-3/8"	50	17	1.916 €
	MDF-NY-0 015	1/2	230 V-I	830	1 200	970	770	610	0,46	(1,73)	5,0	Ø 200	350	1/4"-3/8"	52	22	2.044 €
	MDF-NY-1 015	1/2	230 V-I	890	1 380	1 100	860	650	0,49	(1,78)	5,0	Ø 360	1 700	1/4"-1/2"	66	22	2.158 €
	MDF-NY-1 026	3/4	230 V-I	1 370	2 140	1 700	1 310	970	0,71	(1,89)	9,0	Ø 360	1 700	1/4"-1/2"	74	19	2.300 €
	MDF-NY-1 033	1	230 V-I	1 780	2 680	2 150	1 680	1 250	0,82	(2,10)	9,0	Ø 360	1 700	1/4"-5/8"	76	23	2.618 €
	MDF-NY-1 053	1 1/2	230 V-I *	2 450	3 900	3 060	2 320	1 720	1,22	(1,96)	12,0	Ø 360	1 700	1/4"-3/4"	88	28	3.103 €
	MDF-NY-1 074	2	230 V-I *	3 510	5 260	4 200	3 260	2 470	1,60	(2,11)	16,0	Ø 360	1 700	1/4"-3/4"	90	35	3.905 €
	MDF-NY-2 086	4	400 V-III	4 380	6 670	5 260	4 050	3 030	1,81	(2,32)	13,0	Ø 450	3 600	3/8"-7/8"	98	39	4.383 €
	MDF-NY-2 108	5	400 V-III	5 370	8 060	6 370	4 900	3 740	2,20	3,25	16,0	Ø 450	3 600	3/8"-7/8"	100	36	4.645 €
	MDF-NY-2 136	6 1/2	400 V-III	6 850	10 180	8 250	6 500	5 040	2,99	2,89	19,0	Ø 450	3 600	3/8"-1 1/8"	103	35	5.327 €
R-449A	MDF-NG-0 008	1/3	230 V-I	620	980	810	650	510	0,37	(1,72)	4,0	Ø 200	350	1/4"-3/8"	51	20	1.804 €
	MDF-NG-0 010	3/8	230 V-I	800	1 230	1 020	820	650	0,48	(1,72)	5,0	Ø 200	350	1/4"-3/8"	51	24	1.925 €
	MDF-NG-0 012	1/2	230 V-I	950	1 420	1 180	960	770	0,56	(1,73)	6,0	Ø 200	350	1/4"-3/8"	51	24	2.035 €
	MDF-NG-1 014	1/2	230 V-I	1 160	1 920	1 560	1 240	960	0,68	(1,74)	6,0	Ø 360	1 700	1/4"-1/2"	66	25	2.169 €
	MDF-NG-1 016	5/8	230 V-I	1 320	2 250	1 820	1 440	1 080	0,76	(1,80)	7,0	Ø 360	1 700	1/4"-1/2"	76	25	2.343 €
	MDF-NG-1 018	3/4	230 V-I	1 650	2 690	2 190	1 750	1 360	0,92	(1,87)	8,0	Ø 360	1 700	1/4"-1/2"	76	25	2.465 €
	MDF-NG-1 024	1	230 V-I	2 110	3 560	2 890	2 280	1 720	1,06	(2,07)	12,0	Ø 360	1 700	3/8"-5/8"	78	25	2.702 €
	MDF-NG-1 026	1 1/4	230 V-I *	2 370	3 870	3 160	2 530	1 950	1,18	(2,08)	13,0	Ø 360	1 700	3/8"-5/8"	78	25	2.762 €
	MDF-NG-1 034	1 1/2	230 V-I *	3 060	4 860	3 980	3 200	2 500	1,66	(1,90)	16,0	Ø 360	1 700	3/8"-5/8"	78	27	2.855 €
	MDF-NG-1 038	1 3/4	400 V-III	3 360	5 870	4 740	3 720	2 830	1,60	(2,15)	7,0	Ø 450	3 200	3/8"-5/8"	81	30	3.476 €

Dimensiones DF

Serie 0

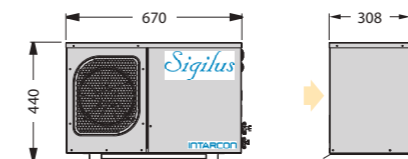

Serie 1

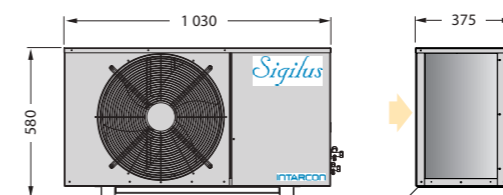

Serie 2

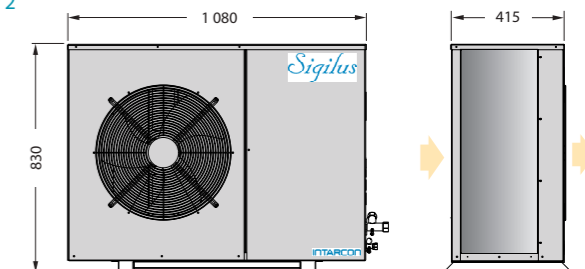

Serie 3

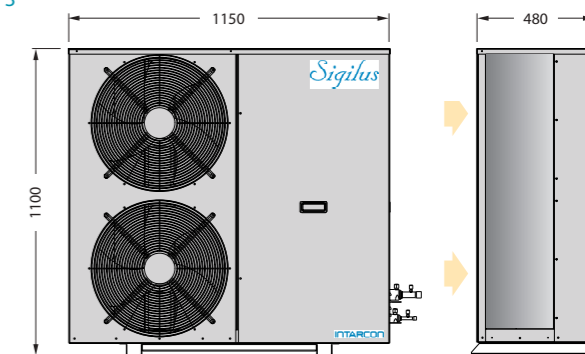

CARACTERÍSTICAS TÉCNICAS	TECHNICAL DATA	CARACTÉRISTIQUES TECHNIQUES
<p>Unidades condensadoras multiservicio que incorporan el sistema VRC (Variable • Refrigerant Capacity) de regulación de capacidad frigorífica, aplicable a compresores herméticos alternativos, constituido por:</p> <ul style="list-style-type: none"> Válvula presostática de aspiración (VP). Válvula presostática de by-pass (VC). Válvula termostática de inyección de líquido (VE). Presostato de control (IP). Separador de aceite. <p>Versiones de las motocondensadoras multiservicio:</p> <ul style="list-style-type: none"> Versión horizontal centrífuga o axial multiservicio intarbox-multi: series MDH-CV/-V Versión horizontal axial silenciosa multiservicio Siligus-multi: series MDF-V Gas no incluido 	<p>Multiservice condensing units that incorporate the VRC (Variable • Refrigerant Capacity) system for regulation of cooling capacity, applicable to hermetic reciprocating compressors, consisting of:</p> <ul style="list-style-type: none"> Pressostatic suction valve (VP). Pressostatic by-pass valve (VC). Thermostatic liquid injection valve (VE). Control pressure switch (IP). Oil separator. <p>Versions of multi-service condenser units:</p> <ul style="list-style-type: none"> Intarbox-multi multiservice horizontal centrifugal or axial version: MDH-CV / -V series. Siligus-multi multi-service horizontal axial silent version: MDF-V Gas not included 	<ul style="list-style-type: none"> Unités de condensation multiservices qui intègrent le système VRC (Variable • Refrigerant Capacity) pour la régulation de la puissance frigorifique, applicable aux compresseurs hermétiques à piston, comprenant: Soupape d'aspiration pressostatique (VP). Vanne by-pass pressostatique (VC). Vanne d'injection thermostatique de liquide (VE). Pressostat de contrôle (IP). Séparateur d'huile. Versions d'unités de condensation multiservices: Versión centrífuga horizontal o multiservicio axial intarbox-multi: séries MDH-CV / -V Versión silenciosa axial horizontal multiservice Siligus-multi: Série MDF-V et Gaz non inclus

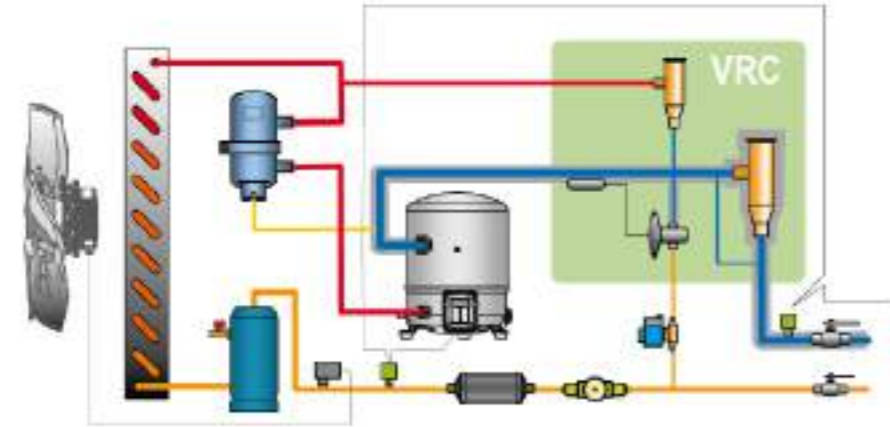
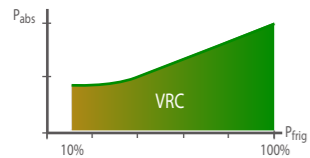

Ejemplo instalación multiservicio / Exemple multi-service installation

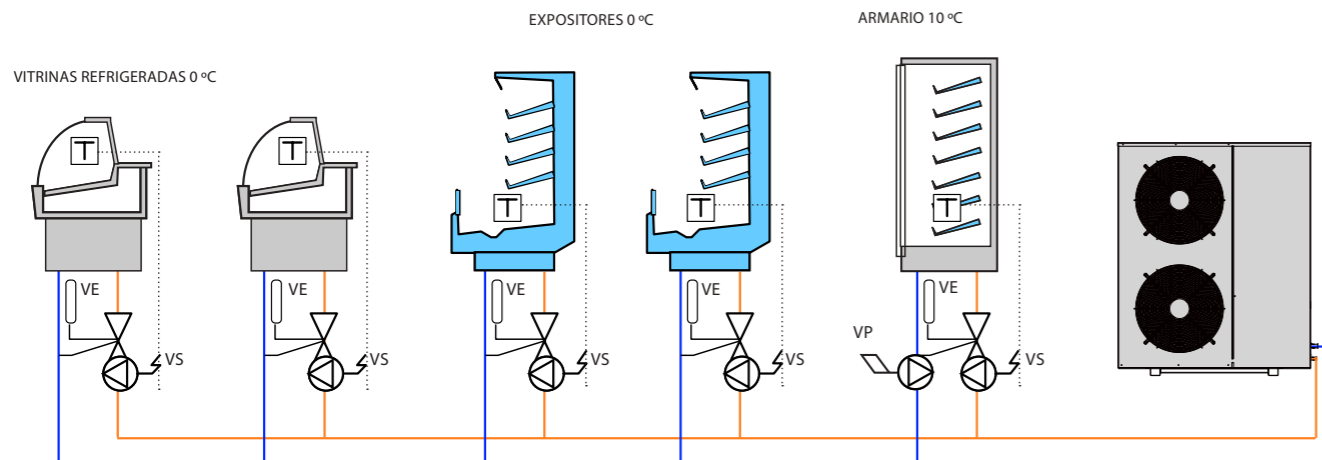

Serie Sigilus

Serie / Modelo	Compresor		Potencia frigorífica EN13215 (W) ⁽¹⁾ T° evap. -10 °C	Potencia frigorífica (W) ⁽²⁾ Temperatura de evaporación				Potencia absorb. nominal (kW)	C.O.P. S.E.P.R. ⁽³⁾	Intens. máxima absorb. (A)	Ventilador ø mm	Caudal (m³/h)	Conexión frigorífica Liq - Gas	Peso (kg)	Nivel presión sonora dB(A) ⁽⁴⁾	PVP versión MY / MG (€)	
	CV	Tensión		0 °C	-5 °C	-10 °C	-15 °C										
R-134a	MDF-VY-2 086	4	400 V-III	4 150	6 670	5 260	4 050	3 030	1,81	(2,30)	12,6	Ø 450	3 600	3/8"-7/8"	98	39	5.608 €
	MDF-VY-2 108	5	400 V-III	5 040	8 060	6 370	4 900	3 740	2,20	3,11	15,6	Ø 450	3 600	3/8"-7/8"	100	36	5.870 €
	MDF-VY-2 136	6 1/2	400 V-III	6 710	10 180	8 250	6 500	5 040	2,99	2,91	18,6	Ø 450	3 600	3/8"-1 1/8"	103	35	6.552 €
	MDF-VY-3 171	8	400 V-III	7 440	11 180	9 090	7 240	5 610	3,70	2,65	22,7	Ø 450	4 000	3/8"-1 1/8"	142	41	7.534 €
	MDF-VY-3 215	10	400 V-III	9 390	13 840	11 330	9 100	7 150	4,43	2,89	28,3	2x Ø 450	6 500	3/8"-1 1/8"	149	40	8.253 €
R-449A	MDF-VY-3 271	13	400 V-III	12 720	17 910	14 890	12 160	9 740	6,24	2,61	37,3	2x Ø 450	6 500	1/2"-1 3/8"	154	39	9.033 €
	MDF-VG-1 038	1 3/4	400 V-III	3 540	5 420	4 420	3 520	2 720	1,59	(2,23)	6,6	Ø 450	3 200	3/8"-5/8"	81	30	4.701 €
	MDF-VG-2 048	2	400 V-III	4 520	6 940	5 640	4 510	3 520	1,97	(2,30)	8,1	Ø 450	3 600	3/8"-3/4"	85	27	5.128 €
	MDF-VG-2 054	2 1/4	400 V-III	5 140	7 810	6 380	5 140	4 060	2,18	3,43	8,6	Ø 450	3 600	3/8"-3/4"	86	27	5.357 €
	MDF-VG-2 060	3	400 V-III	5 880	8 790	7 250	5 880	4 690	2,59	3,25	9,6	Ø 450	3 600	3/8"-3/4"	87	27	5.735 €
	MDF-VG-2 068	3 1/2	400 V-III	6 600	9 750	8 110	6 600	5 290	2,98	3,05	10,1	Ø 450	3 600	1/2"-3/4"	88	26	5.963 €
	MDF-VG-3 086	4	400 V-III	6 950	11 060	9 070	7 270	5 700	3,45	2,15	12,7	Ø 450	4 000	1/2"-7/8"	115	39	6.843 €
	MDF-VG-3 108	5	400 V-III	9 200	14 390	11 880	9 600	7 610	4,41	3,05	16,3	2x Ø 450	6 500	1/2"-7/8"	120	36	7.485 €
	MDF-VG-4 136	6	400 V-III	11 750	18 110	15 090	12 260	9 780	5,66	3,03	19,2	2x Ø 450	7 000	1/2"-1 1/8"	135	35	8.180 €
	MDF-VG-4 160	8	400 V-III	13 390	20 880	17 380	14 100	11 100	6,63	2,76	23,2	2x Ø 450	7 000	5/8"-1 1/8"	157	41	8.677 €

Serie Intarbox

Versión axial	Compresor		Potencia frigorífica EN13215 (W) ⁽¹⁾ T° evap. -10 °C	Potencia frigorífica (W) ⁽²⁾ Temperatura de evaporación				Potencia absorb. nominal (kW)	C.O.P. S.E.P.R. ⁽³⁾	Intens. máxima absorb. (A)	Conexión frigorífica Liq - Gas	Peso (kg)	Nivel presión sonora dB(A) ⁽⁴⁾	PVP versión MY / MG (€)	Versión centrífuga				
	CV	Tensión		0 °C	-5 °C	-10 °C	-15 °C								Serie / Modelo	Caudal (m³/h)	P.E.D. (mmca) ⁽⁵⁾	PVP versión CMY / CMG (€)	
R-134a	MDH-VY-4 086	4	400 V-III	4 020	6 210	5 000	3 940	3 020	2,08	(2,07)	13,68	3/8"-7/8"	107	48	5.280 €	MDH-CVY-4 086	3 500	100	6.363 €
	MDH-VY-4 108	5	400 V-III	4 870	7 310	5 950	4 760	3 730	2,48	(2,07)	16,68	3/8"-7/8"	109	45	5.751 €	MDH-CVY-4 108	3 500	100	6.832 €
	MDH-VY-4 136	6 1/2	400 V-III	6 500	9 400	7 750	6 290	5 000	3,28	2,78	19,68	3/8"-1 1/8"	112	44	6.173 €	MDH-CVY-4 136	3 500	100	7.258 €
	MDH-VY-5 171	8	400 V-III	7 560	11 270	9 150	7 280	5 650	3,90	2,73	23,65	3/8"-1 1/8"	162	50	8.889 €	MDH-CVY-5 171	3 600	120	9.028 €
	MDH-VY-5 215	10	400 V-III	9 310	13 380	11 000	8 880	7 000	4,54	2,76	28,65	3/8"-1 1/8"	166	49	9.028 €	MDH-CVY-5 215	3 600	120	9.511 €
R-449A	MDH-VY-5 271	13	400 V-III	12 600	17 130	14 330	11 770	9 470	6,39	2,51	37,65	1/2"-1 3/8"	171	48	9.719 €	MDH-CVY-5 271	3 600	120	10.199 €
	MDH-VG-4 048	2	400 V-III	4 420	6 140	5 080	4 140	3 310	2,49	(1,78)	13,20	3/8"-3/4"	95	36	4.717 €	MDH-CVG-4 048	3 500	100	5.798 €
	MDH-VG-4 054	2 1/2	400 V-III	5 030	6 890	5 730	4 700	3 790	2,70	3,03	13,70	3/8"-3/4"	96	36	5.131 €	MDH-CVG-4 054	3 500	100	6.215 €
	MDH-VG-4 060	3	400 V-III	5 740	7 740	6 480	5 340	4 340	3,12	2,85	14,70	3/8"-3/4"	97	35	5.613 €	MDH-CVG-4 060	3 500	100	6.771 €
	MDH-VG-4 068	3 1/2	400 V-III	6 410	8 520	7 170	5 950	4 870	3,51	2,71	15,20	1/2"-3/4"	98	35	5.742 €	MDH-CVG-4 068	3 500	100	7.396 €
	MDH-VG-5 086	4	400 V-III	7 270	10 820	8 870	7 080	5 530	3,66	2,64	17,70	1/2"-7/8"	152	48	7.096 €	MDH-CVG-5 086	3 600	120	8.031 €
	MDH-VG-5 108	5	400 V-III	9 290	13 310	11 050	9 010	7 140	4,66	2,57	20,70	1/2"-7/8"	154	45	7.443 €	MDH-CVG-5 108	3 600	120	8.543 €

El sistema VRC se compone de un juego de válvulas de regulación de presión y temperatura capaces de variar de forma progresiva la capacidad frigorífica de un compresor entre un 100 % y un 10 % de su potencia nominal, a la vez que se reduce la potencia eléctrica absorbida y se protege el compresor al mantener su relación de compresión dentro de los márgenes de seguridad, evitando el riesgo de sobrecalentamiento.

Sistema VRC (Regulación de capacidad frigorífica)

El sistema VRC aplicado a un compresor hermético alternativo adapta el flujo de refrigerante a la demanda de las unidades evaporadoras manteniendo constante la presión en la línea de aspiración.

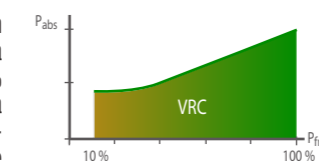

- El sistema VRC se caracteriza por:
- Constituido exclusivamente por componentes mecánicos de alta fiabilidad.
 - Mantiene constante la presión de evaporación.
 - Protege al compresor ante el riesgo de sobrecalentamiento del motor.
 - Mantiene la relación de compresión del compresor dentro de los límites de seguridad.
- Las motocondensadoras dotadas del sistema VRC, permiten centralizar la producción frigorífica de un conjunto de servicios, manteniendo constante la presión y temperatura del refrigerante en los evaporadores.

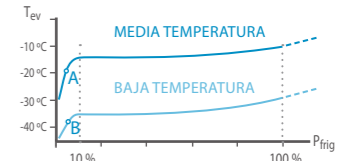

- El sistema VRC puede regularse fácilmente para fijar una presión de evaporación mínima. El ajuste de fábrica proporciona las siguientes temperaturas mínimas de evaporación:
- Equipos de media temperatura: -13 °C
 - Equipos de baja temperatura: -35 °C

Con demanda inferior al 10 % de la potencia nominal, la característica de la curva de presión de evaporación cae hacia el valor mínimo admitido por el compresor, desconectando el presostato de baja presión (puntos A y B) y parando el compresor. De este modo, las motocondensadoras multiservicio están diseñadas para el control de paro/marcha por baja presión (caída por baja o pump down). Alternativamente el paro marcha del compresor puede realizarse a través de un contacto abierto/cerrado externo.

5 ENFRIADORES

BEVERAGE COOLERS

REFROIDISSEURS DE BOISSONS



ELEG Página 215
Enfriador de botellas
Bottle cooler
Bouteille Cooler



EVRV-370/430/750 Pág 233
Armario puertas abatibles vinos
Swing door merchandiser wine
Armoire portes battantes vins



EBI / DSD Página 217
Enfriador de botellas SNACK
Bottle cooler SNACK
Bouteille Cooler SNACK



AGW/620-125 Pág 235
Armario puertas abatibles vinos 1 y 2 cuerpos
Swing door merchandiser wine 1 and 2 bodies
Armoire portes battantes vins 1 et 2 corps



DEC-3 Página 219
Expositor refrigerado 300
Chilled merchandiser 300
Réfrigère 300



EFIW Pág 237
Armario puertas abatibles vinos
Swing door merchandiser wine
Armoire portes battantes vins



DEC-400
DECCV-450 Página 220
Expositor refrigerado 400 / 450
Chilled merchandiser 400 / 450
Réfrigère 400 / 450



DEBR Página 239
Armario puertas abatibles
Swing door merchandiser
Armoire portes battantes



DECV-520 Página 221
Expositor refrigerado 520
Chilled merchandiser 520
Réfrigère 520



EHB Página 241
Expositor refrigerador vertical 900
Upright cooler exhibitor 900
Présentoir réfrigéré vertical 900



EVRV-370 Página 223
Expositor refrigerado EVRV
Chilled merchandiser EVRV
Réfrigère EVRV



DSBE Página 243
Expositor refrigerador snack bar
Upright cooler exhibitor snack bar
Présentoir réfrigéré vertical snack bar



EVRV/EVRVF-430
Página 225
Expositor refrigerado y congelados 430
Chilled and frozen merchandiser 430
Réfrigère et congelé 430



V / DEB Página 247
Enfriador de líquidos y barriles
Liquid keg and cooler
Flux refroidisseur



EVR/EVRF-620
Página 227
Expositor refrigerado y congelados 620
Chilled and frozen merchandiser 620
Réfrigère et congelé 620



EAP Página 253
Enfriador de agua
Water cooler
Eau refroidisseur



EVRV/EVRVF-750
Página 229
Expositor refrigerado y congelados 750
Chilled and frozen merchandiser 750
Réfrigère et congelé 750



PRO-60/90 Página 255
Vitrina mural promoción
Mural display cabinet promotion
Promotion d'armoire murale



AGPA / ARPA-125
ARA / ARAC-125 Pág 231
Armario puertas abatibles
Swing door merchandiser
Armoire portes battantes



DEC Página 257
Escarchador de copas
Glass-Froster
Givré de boissons

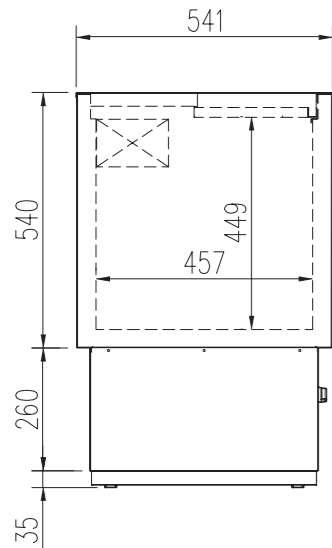

EBEG-70-EA



EBEG-100-EA



EBEG-150-EA



EBEG-200-EA

CARACTERÍSTICAS TÉCNICAS

- Exterior e interior, según especificaciones.
- EA = Exterior en acero plastificado e interior en acero galvanizado.
- I = Exterior e interior acero inox AISI-304 18/10.
- Separadores interiores de alambre en acero plastificado.
- Unidad condensadora ventilada y extraíble.
- Aislamiento de poliuretano inyectado, densidad 40 Kg/m³, bajo GWP y cero efecto ODP
- Evaporador estático.
- Control de temperatura.
- Interruptor general ON OFF luminoso.
- Refrigerante R-600a (excepto modelo Subzero R-290)
- Tensión monofásica 230v 50Hz
- Temperatura de trabajo K1(0+7°C), clase climática CC2(32°C 65%H.R.), según EN16902

TECHNICAL DATA

- Exterior and interior according to specifications-
- EA = Plasticized steel exterior and galvanized interior.
- I = AISI-304 18/10 stainless steel exterior and interior.
- Plasticised steel wire interior separators.
- Ventilated, pull-out condenser unit.
- 40 Kg/m³ density polyurethane insulation, low GWP and zero ODP effect
- Static evaporator.
- Temperature control.
- Luminous main switch ON OFF.
- R-600a Refrigerant (except Subzero R-290 model)
- Single phase voltage 230v 50Hz
- Température de fonctionnement K1 (0 + 7 ° C), climatic class CC2 (32 ° C 65% R.H.), according to EN16902

CARACTÉRISTIQUES TECHNIQUES

- Extérieur et intérieur, selon spécifications
- EA = Extérieur en acier plastifié et intérieur en acier galvanisé
- I = Extérieur et intérieur en acier inox AISI-304 18/10
- Séparateurs intérieures en fil de fer en acier plastifié
- Condensateur ventilé et extractible
- Isolation en polyuréthane injecté, densité 40 Kg/m³, GWP faible et effet nul ODP
- Évaporateur statique
- Contrôle de température
- Interrupteur général ON-OFF lumineux
- Réfrigérant R-600a (sauf modèle Subzero R-290)
- Tension monophasée 230v 50Hz
- Température de fonctionnement K1 (0 + 7 ° C), classe climatique CC2 (32 ° C 65% H.R.), selon EN16902

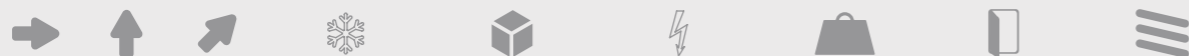

Modelo	Largo	Alto	Fondo	Potencia frigorífica	Volumen bruto	Consumo nominal	Peso Neto	Puertas	Separador Interior
Model	Length	Height	Depth	Cooling capacity	Gross volume	Nominal Power	Net Weight	Doors	Interior separator
Modèle	Longueur	Hauteur	Profondeur	Puissance frigorifique	Volume Brut	Consommation nominale	Poid Net	Portes	Séparateurs intérieurs
	mm.	mm.	mm.	(W)	(l)	(W)	(Kg)	(Uds)	(Uds)
EBEG-70	705	840	545	144	129	66	42	1	0
EBEG-100	1020	840	545	167	184	111	52	2	1
EBEG-150	1510	840	545	236	290	128	68	3	2
EBEG-200	2010	840	545	360	389	187	84	4	3
EBEG-100-SZ	1020	840	545	369	142	408	52	2	1

OPCIONES · OPTIONS · OPTIONS

Otros Refrigerantes	consultar - consult - consulter
230v 60Hz / 115v 60Hz	consultar - consult - consulter

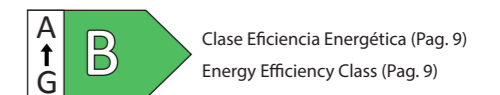

Clase Eficiencia Energética (Pag. 9)
 Energy Efficiency Class (Pag. 9)



EBEG-70-EA **583 €**
 EBEG-70-I **699 €**

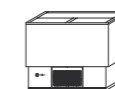

EBEG-100-EA **673 €**
 EBEG-100-I **828 €**
 EBEG-100-SZ-EA **1.003 €**
 EBEG-100-SZ-I **1.203 €**

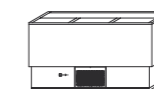

EBEG-150-EA **904 €**
 EBEG-150-I **1.164 €**



EBEG-200-EA **1.049 €**
 EBEG-200-I **1.326 €**

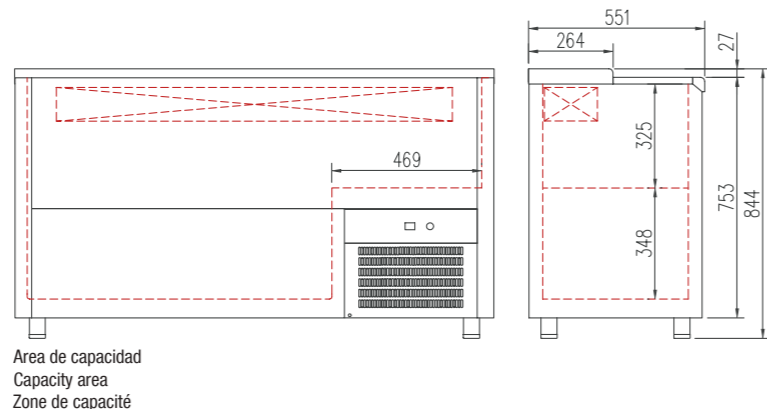
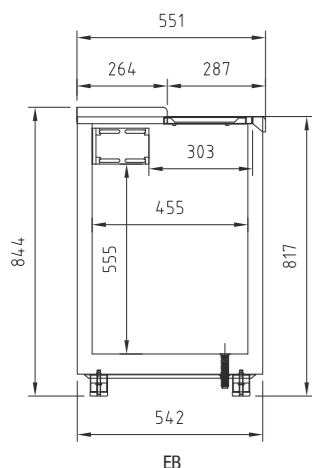

Area de capacidad
Capacity area
Zone de capacité



TERMOSTATO DIGITAL OPCIONAL
OPTIONAL THERMOSTAT DIGITAL
DIGITAL THERMOSTAT EN OPTION

EBI-200



EBI-100



DSD Producto refrigerado por inundación
DSD Product cooled flood
DSD Produit refroidi inondations

DSD-100

Producto no refrigerado
Product not cooled
Produit non refroidi



Clase Eficiencia Energética (Pag. 9)
Energy Efficiency Class (Pag. 9)

CARACTERÍSTICAS TÉCNICAS	TECHNICAL DATA	CARACTÉRISTIQUES TECHNIQUES
<p>EBI</p> <ul style="list-style-type: none"> Exterior en acero inox AISI304 18/10, excepto el respaldo Interior en acero inox AISI304 18/10 Puertas inox deslizantes sobre bastidor Encimera de acero inox AISI304 18/10 Separadores interiores en alambre de acero plastificado Aislamiento de poliuretano inyectado, densidad 40 Kg/m³, bajo GWP y cero efecto ODP Evaporador estático Unidad condensadora ventilada y extraíble Control mecánico de temperatura, digital con pantalla, en opción. Refrigerante R-600a Tensión monofásica 230v 50Hz Temperatura de trabajo K1(0+7°C), clase climática CC2(32°C 65%R.H.), según EN16902 <p>DSD</p> <ul style="list-style-type: none"> Exterior e interior en acero inox AISI-304 18/10 Cuba interior, incorpora llave de paso para vaciado del agua Estante inferior para almacenamiento de botellas Patas regulables inox AISI-304 18/10 Evaporador por placa fría Enfriamiento por baño en agua fría Unidad condensadora ventilada Aislamiento de poliuretano inyectado, densidad 40 Kg/m³, bajo GWP y cero efecto ODP Control digital de temperatura Temperatura de trabajo +12°C +16°C a 32°C ambiente Refrigerante gas R-290 	<p>EBI</p> <ul style="list-style-type: none"> Stainless steel sliding doors AISI30418/10 stainless steel worktop Separator made of plasticized steel wire 40 Kg/m³ density polyurethane insulation, low GWP and zero ODP effect Static evaporator Removable and fan assisted condenser unit Mechanic control of temperature, digital with display as optional R-600a Refrigerant Single phase voltage 230v 50Hz Température de fonctionnement K1 (0 + 7 ° C), climatic class CC2 (32 ° C 65% R.H.), according to EN16902 <p>DSD</p> <ul style="list-style-type: none"> AISI-304 18/10 stainless steel exterior and interior Drain tap Bottom shelf for storage of bottles AISI -304 18/10 adjustable legs Cold plate evaporator Cold water bath system Fan assisted condenser unit 40 Kg/m³ density polyurethane insulation, low GWP and zero ODP effect Digital electronic control of temperature Operating temperature +12°C +16°C , 32°C ambient R-290 gas refrigerant 	<p>EBI</p> <ul style="list-style-type: none"> Portes inoxydables coulissantes en sur châssis Plan de travail en acier inoxydable AISI-304 18/10 Séparateurs intérieurs en fil de fer en acier plastifié Isolation en polyuréthane injecté, densité 40 Kg/m³, GWP faible et effet nul ODP Évaporateur statique Condensateur ventilé et extractible Contrôle mécanique de la température, digital avec écran, en option Réfrigérant R-600a Tension monophasée 230v 50Hz Température de fonctionnement K1 (0 + 7 ° C), classe climatique CC2 (32 ° C 65% H.R.), selon EN16902 <p>DSD</p> <ul style="list-style-type: none"> Extérieur et intérieur en acier inoxydable AISI-304 18/10 Cuba intègre l'intérieur robinet pour évacuer l'eau Étagère inférieure pour le stockage de bouteille Pieds réglables en acier inoxydable AISI-304 18/10 Plaque froide évaporateur Bain de refroidissement à l'eau froide Unité de condensation ventilé Isolation en polyuréthane injecté, densité 40 kg / m³, faible GWP et ODP nul effet Contrôle numérique de la température Température de fonctionnement 12 ° C 16 ° C à 32 ° C de température ambiante R-290 gaz réfrigérant

Modelo	Largo	Alto	Fondo	Potencia frigorífica	Volumen bruto	Consumo nominal	Peso Neto	Puertas	Separador Interior
Model	Length	Height	Depth	Cooling capacity	Gross volume	Nominal Power	Net Weight	Doors	Interior separator
Modèle	Longueur	Hauteur	Profondeur	Puissance frigorifique	Volume Brut	Consommation nominale	Poid Net	Portes	Séparateurs intérieurs
	mm.	mm.	mm.	(W)	(l)	(W)	(Kg)	(Uds)	(Uds)
EB-100	1010	850	550	176	270	125	61	2	1
EB-150	1500	850	550	205	420	132	77	3	2
EB-200	1990	850	550	304	580	180	96	4	3
EB-250	2480	850	550	502	720	208	115	5	4
EB-300	2970	850	550	533	860	244	134	6	5
DSD-100	1010	800	545	502	63	290	52	-	-
DSD-150	1500	800	545	502	85	350	65	-	-

PVP de opcionales incluidos en equipo, no como repuesto / PVP of options included in the equipment, not as a spare part / PVP d'options incluses dans l'équipement, pas en tant que pièce de rechange

OPCIONES - OPTIONS - OPTIONS

Set 4 ruedas	4 Castors set	Jeu 4 roulettes	98€ x set
Set 6 ruedas	6 Castors set	Jeu 6 roulettes	146 € x set
Motor lado izquierdo	Left side engine	Moteur côté gauche	69 €
Control digital con pantalla	Digital control with display	Contrôle digital avec écran	110 €
Puerta con cerradura	Lockable door	Porte verrouillable	46 €
Otros Refrigerantes	Other refrigerants	Autres réfrigérants	consultar - consult- consulter
Bandeja de goteo + evaporación automática	Drip tray + automatic evaporation	Bac de récupération + évaporation automatique	consultar - consult- consulter

Características técnicas y constructivas sujetas a variación sin previo aviso. / We reserve the right to change specifications without prior notice. / Sujet technique et la conception de modifications sans préavis.

	DSD-100-I	1.970 €		DSD-150-I	2.260 €
	EBI-100	1.086 €		EBI-150	1.428 €
	EBI-200	1.662 €		EBI-250	2.051 €
	EBI-300	2.614 €			



OPCIONALES
OPTIONS - OPTIONS



Personalización a medida
Customization
Personnalisation



Vinilo magnético
Magnetic vinyl
Vinyle magnétique



Panelado madera (consultar modelos)
Wood paneling (consult models)
Lambris de bois (consulter les modèles)



Puerta aluminio - consultar
Aluminium door - consult
Serrure de porte



Ruedas nylon diámetro 120 mm.
Nylon wheels diameter 120 mm.
Roues en nylon diamètre 120 mm.

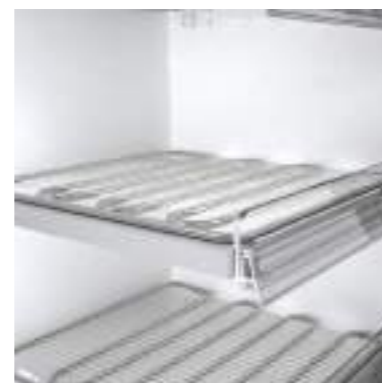

Detalle estante evaporador estático
Static evaporator shelf detailséparateur de canettes Détail de l'étagère de l'évaporateur statique

Otras especificaciones: Consultar
Other specifications: Consult

EXPOSITOR REFRIGERADO SOBRE-MOSTRADOR SERIE 3
3 RANGE ON COUNTER CHILLED MERCHANDISER - 3 SÉRIES PRÉSENTOIR RÉFRIGÉRÉ

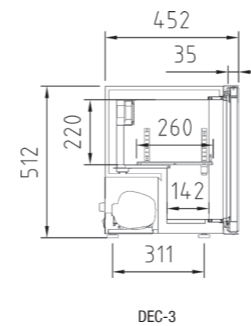

Puerta de aluminio - Consultar
Aluminum door - Consult
Porte aluminium - Consulter



Decoración opcional: consultar
Optional decoration: consult
Décoration option: consulter

DEC-3



Clase Eficiencia Energética (Pag. 9)
Energy Efficiency Class (Pag. 9)

CARACTERÍSTICAS TÉCNICAS	TECHNICAL DATA	CARACTÉRISTIQUES TECHNIQUES
<p>DEC-3</p> <ul style="list-style-type: none"> Exterior e interior en acero plastificado blanco <p>CARACTERISITCAS COMUNES</p> <ul style="list-style-type: none"> Diseñados para bebidas y productos envasados Estantes de alambre de acero plastificado, regulables en altura Compresor hermético alto par de arranque Evaporador ventilado impreso en placa de aluminio Control digital de temperatura y descarches Iluminación interior vertical LED Unidad condensadora estática Aislamiento de poliuretano inyectado, libre CFCs, densidad 40 Kg/m³ Evaporación automática del agua de descarche Temperatura de trabajo K1(0+7°C), clase climatica CC2(32°C 65%R.H.), según EN16902 Tensión monofásica 230V 50/60 Hz Refrigerante R-600a 	<p>DEC-3</p> <ul style="list-style-type: none"> Exterior and interior in white plastic coated steel <p>FEATURES IN COMMON</p> <ul style="list-style-type: none"> Designed for beverages and packaged products Shelves plastic coated steel wire, adjustable height Hermetic compressor high starting torque Ventilated evaporator printed on aluminum plate Digital temperature control and defrost Interior lighting vertical LED Static condensing unit Insulation: Polyurethane, without CFCs, density 40 Kg / m³ Automatic evaporation of defrost water Working temperature K1 (0 + 7°C), climatic class CC2 (32°C 65% R.H.), according to EN16902 Voltage 230V 50/60 Hz Refrigerant R-600a 	<p>DEC-3</p> <ul style="list-style-type: none"> Extérieur et intérieur en acier plastifié de couleur blanche. <p>CARACTÉRISTIQUES COMMUNES :</p> <ul style="list-style-type: none"> Conçus pour boissons et produits emballés. Etagères en fil d'acier plastifié, réglables en hauteur. Compresseur hermétique à haut couple de démarrage. Évaporateur ventilé imprimé sur plaque d'aluminium Contrôle digital de température et du dégivrage. Eclairage intérieur verticale LED Condensateur statique Isolation en polyuréthane injecté, densité de 40 Kg / m³, faible GWP et aucun effet ODP. Évaporation automatique de l'eau de dégivrage Température de fonctionnement K1 (0 + 7 ° C), classe climatique CC2 (32 ° C 65% H.R.), selon EN16902 Tension monophasique 230V 50/60 Hz Gaz réfrigérant R-600a

Modelo Modèle	Largo Length Longueur (mm)	Alto Height Hauteur (mm)	Fondo Depth Profondeur (mm)	Pantalla publicidad Canopy Marquise	Facings lata 33cl 33 cl Facings 33 cl Facings (uds.)	Capacidad lata 33cl 33cl can capacity Capacité 33cl boîtes (uds.)	Potencia frig. Frig. Power Puissance frig. (W)	Consumo Nominal Nominal Consumption Consommation Nominale (W)	Capacidad Capacity Exposition L	Estantes Shelves Étagères
DEC-3	415	512	462	NO	4	24	142	85	38	1+1

OPCIONES - OPTIONS - OPTIONS			
Cerradura lateral	Side Lock	Serrure latérale	35€
Exterior negro	Black exterior	Noir extérieur	150€
Interior negro	230v 60Hz / 115v 60Hz.	230v 60Hz / 115v 60Hz.	150€
Otros Refrigerantes	Other refrigerants	Autres réfrigérants	consultar - consult - consulter
230v 60Hz / 115v 60Hz.	230v 60Hz / 115v 60Hz.	230v 60Hz / 115v 60Hz.	consultar - consult - consulter

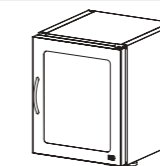

DEC-3 **715 €**

Características técnicas y constructivas sujetas a variación sin previo aviso. / We reserve the right to change specifications without prior notice. / Sujet technique et la conception de modifications sans préavis.

EXPOSITOR REFRIGERADO SOBRE-MOSTRADOR SERIE 400 / 450
400 / 450 RANGE ON COUNTER CHILLED MERCHANDISER · 400 / 450 SÉRIES PRÉSENTOIR RÉFRIGÉRÉ

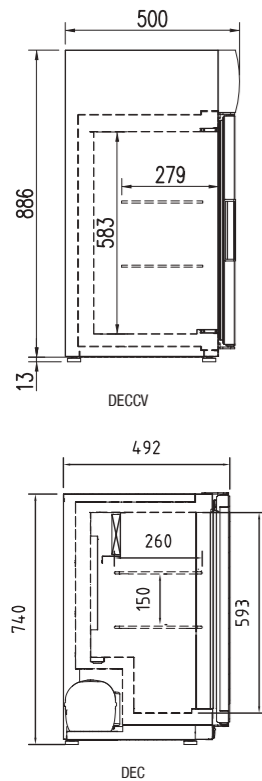

DEC-400

DECCV-450

A
G **C** Clase Eficiencia Energética (Pag. 9)
Energy Efficiency Class (Pag. 9)

CARACTERÍSTICAS TÉCNICAS

- DEC-400 / DECCV-450
- Exterior e interior en acero plastificado blanco
- CARACTERÍSTICAS COMUNES**
- Diseñados para bebidas y productos envasados
 - Estantes de alambre de acero plastificado, regulables en altura
 - Compresor hermético alto par de arranque
 - Evaporador ventilado impreso en placa de aluminio
 - Control digital de temperatura y descarches
 - Iluminación interior LED
 - Unidad condensadora estática, libre de mantenimiento
 - Aislamiento de poliuretano inyectado, libre CFCs, densidad 40 Kg/m³
 - Evaporación automática del agua de descarche
 - Temperatura de trabajo K1(0+7°C), excepto SZ que es K3(-3,5°C+1°C), clase climática CC2(32°C 65% H.R.), según EN16902
 - Tensión monofásica 230V 50/60 Hz
 - Refrigerante R-600a

TECHNICAL DATA

- DEC-400 / DECCV-450
- Exterior and interior in white plastic coated steel
- FEATURES IN COMMON**
- Designed for beverages and packaged products
 - Shelves plastic coated steel wire, adjustable height
 - Hermetic compressor high starting torque
 - Ventilated evaporator printed on aluminum plate
 - Digital temperature control and defrost
 - Interior lighting LED
 - Static condensing unit, maintenance-free
 - Insulation: Polyurethane, without CFCs, density 40 Kg / m³
 - Automatic evaporation of defrost water
 - Working temperature K1 (0 + 7°C), except SZ which is K3 (-3.5°C + 1°C), climatic class CC2 (32°C 65% R.H.), according to EN16902
 - Voltage 230V 50/60 Hz
 - Refrigerant R-600a

CARACTÉRISTIQUES TECHNIQUES

- DEC-400 / DECCV-450
- Extérieur et intérieur en acier plastifié de couleur blanche.
- CARACTÉRISTIQUES COMMUNES :**
- Conçus pour boissons et produits emballés.
 - Etagères en fil d'acier plastifié, réglables en hauteur.
 - Compresseur hermétique à haut couple de démarrage.
 - Évaporateur ventilé imprimé sur plaque d'aluminium
 - Contrôle digital de température et du dégivrage.
 - Éclairage intérieur LED
 - Unité de condensation statique, sans entretien
 - Isolation en polyuréthane injecté, densité de 40 Kg / m³, faible GWP et aucun effet ODP.
 - Évaporation automatique de l'eau de dégivrage
 - Température de fonctionnement K1 (0 + 7 ° C), sauf SZ qui est K3 (-3,5 ° C + 1 ° C), classe climatique CC2 (32 ° C 65% H.R.), selon EN16902
 - Tension monophasique 230V 50/60 Hz
 - Gaz réfrigérant R-600a

Modelo Modèle	Largo Length Longueur (mm)	Alto Height Hauteur (mm)	Fondo Depth Profondeur (mm)	Pantalla pulicidad Canopy Marquise	Facings lata 33cl 33 cl Facings 33 cl Facings (uds.)	Capacidad lata 33cl 33cl can capacity Capacité 33cl boîtes (uds.)	Potencia frig. Frig. Power Puissance frig. (W)	Consumo Nominal Nominal Consumption Consommation Nominale (W)	Volumen bruto Gross volume Volume Brut L	Estantes Shelves Étagères
DECCV-450	450	900	500	1	5	55	156	111	75	2
DECCV-450-SZ	450	900	500	1	5	55	187	162	75	2
DEC-400	450	740	495	NO	5	45	156	99	69	2
DEC-400-SZ	450	740	495	NO	5	45	187	162	69	2

OPCIONES · OPTIONS · OPTIONS

Cerradura lateral	Side Lock	Serrure latérale	35€
Exterior negro	Black exterior	Noir extérieur	155€
Interior negro	230v 60Hz / 115v 60Hz.	230v 60Hz / 115v 60Hz.	155€
Otros Refrigerantes	Other refrigerants	Autres réfrigérants	consultar - consult - consulter
230v 60Hz / 115v 60Hz.	230v 60Hz / 115v 60Hz.	230v 60Hz / 115v 60Hz.	consultar - consult - consulter

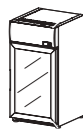

DECCV-450 **850 €**

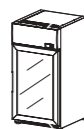

DECCV-450-SZ **1.092 €**



DEC-400 **806 €**



DEC-400-SZ **1.046 €**

Características técnicas y constructivas sujetas a variación sin previo aviso. / We reserve the right to change specifications without prior notice. / Sujet technique et la conception de modifications sans préavis.

EXPOSITOR REFRIGERADO SOBRE-MOSTRADOR SERIE 520
520 RANGE ON COUNTER CHILLED MERCHANDISER · 520 SÉRIES PRÉSENTOIR RÉFRIGÉRÉ

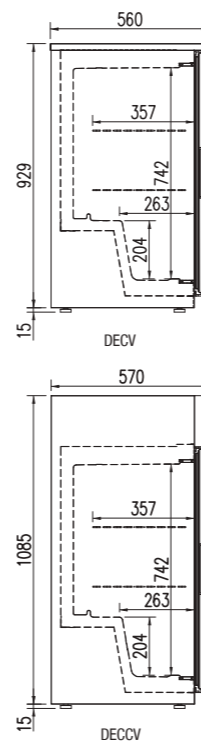

Puerta de aluminio - Consultar
Aluminum door - Consult
Porte aluminium - Consulter

DECCV-520

DECV-520

A
G **C** Clase Eficiencia Energética (Pag. 9)
Energy Efficiency Class (Pag. 9)

CARACTERÍSTICAS TÉCNICAS

- DECCV-520 / DECCV-520
- Exterior e interior en acero plastificado blanco

- CARACTERÍSTICAS COMUNES**
- Diseñados para bebidas y productos envasados
 - Estantes de alambre de acero plastificado, regulables en altura
 - Compresor hermético alto par de arranque
 - Evaporador ventilado impreso en placa de aluminio
 - Control digital de temperatura y descarches
 - Iluminación interior LED
 - Unidad condensadora ventilada
 - Aislamiento de poliuretano inyectado, libre CFCs, densidad 40 Kg/m³
 - Evaporación automática del agua de descarche
 - Temperatura de trabajo K1(0+7°C), excepto SZ que es K3(-3,5°C+1°C), clase climática CC2(32°C 65% H.R.), según EN16902
 - Tensión monofásica 230V 50/60 Hz
 - Refrigerante R-600a

TECHNICAL DATA

- DECCV-520 / DECCV-520
- Exterior and interior in white plastic coated steel

- FEATURES IN COMMON**
- Designed for beverages and packaged products
 - Shelves plastic coated steel wire, adjustable height
 - Hermetic compressor high starting torque
 - Ventilated evaporator printed on aluminum plate
 - Digital temperature control and defrost
 - Interior lighting LED
 - Ventilated condensing unit
 - Insulation: Polyurethane, without CFCs, density 40 Kg / m³
 - Automatic evaporation of defrost water
 - Working temperature K1 (0 + 7°C), except SZ which is K3 (-3.5°C + 1°C), climatic class CC2 (32°C 65% R.H.), according to EN16902
 - Voltage 230V 50/60 Hz
 - Refrigerant R-600a

CARACTÉRISTIQUES TECHNIQUES

- DECCV-520 / DECCV-520
- Extérieur et intérieur en acier plastifié de couleur blanche.

- CARACTÉRISTIQUES COMMUNES :**
- Conçus pour boissons et produits emballés.
 - Etagères en fil d'acier plastifié, réglables en hauteur.
 - Compresseur hermétique à haut couple de démarrage.
 - Évaporateur ventilé imprimé sur plaque d'aluminium
 - Contrôle digital de température et du dégivrage.
 - Éclairage intérieur LED
 - Condensateur ventilé
 - Isolation en polyuréthane injecté, densité de 40 Kg / m³, faible GWP et aucun effet ODP.
 - Évaporation automatique de l'eau de dégivrage
 - Température de fonctionnement K1 (0 + 7 ° C), sauf SZ qui est K3 (-3,5 ° C + 1 ° C), classe climatique CC2 (32 ° C 65% H.R.), selon EN16902
 - Tension monophasique 230V 50/60 Hz
 - Gaz réfrigérant R-600a

Modelo Modèle	Largo Length Longueur (mm)	Alto Height Hauteur (mm)	Fondo Depth Profondeur (mm)	Pantalla pulicidad Canopy Marquise	Facings lata 33cl 33 cl Facings 33 cl Facings (uds.)	Capacidad lata 33cl 33cl can capacity Capacité 33cl boîtes (uds.)	Potencia frig. Frig. Power Puissance frig. (W)	Consumo Nominal Nominal Consumption Consommation Nominale (W)	Volumen bruto Gross volume Volume Brut L	Estantes Shelves Étagères
DECCV-520	520	1100	570	1	6	108	156	125	116	2
DECCV-520-SZ	520	1100	570	1	6	108	187	176	116	2
DECV-520	520	945	560	NO	6	108	156	113	116	2
DECV-520-SZ	520	945	560	NO	6	108	187	164	116	2

OPCIONES · OPTIONS · OPTIONS

Cerradura lateral	Side Lock	Serrure latérale	35€
Exterior negro	Black exterior	Noir extérieur	160€
Interior negro	230v 60Hz / 115v 60Hz.	230v 60Hz / 115v 60Hz.	160€
Otros Refrigerantes	Other refrigerants	Autres réfrigérants	consultar - consult - consulter
230v 60Hz / 115v 60Hz.	230v 60Hz / 115v 60Hz.	230v 60Hz / 115v 60Hz.	consultar - consult - consulter

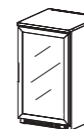

DECV-520 **1.053 €**

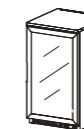

DECV-520-SZ **1.274 €**

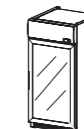

DECCV-520 **1.071 €**



DECCV-520-SZ **1.344 €**

Características técnicas y constructivas sujetas a variación sin previo aviso. / We reserve the right to change specifications without prior notice. / Sujet technique et la conception de modifications sans préavis.

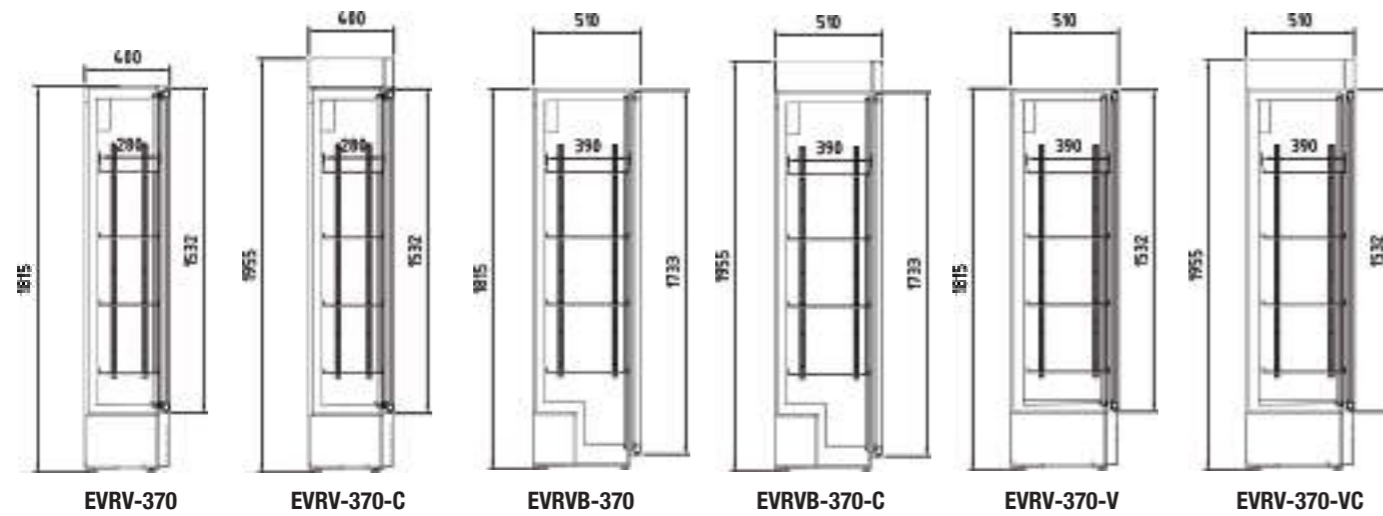

EV RV-370-C

EV RV-370

CARACTERÍSTICAS TÉCNICAS

TECHNICAL DATA

CARACTÉRISTIQUES TECHNIQUES

- Exterior e interior en acero plastificado blanco
- Diseñados para bebidas y productos envasados
- Estantes de alambre de acero plastificado, regulables en altura
- Compresor hermético alto par de arranque
- Evaporador ventilado impreso en placa de aluminio
- Control digital de temperatura y descarches
- Iluminación interior LED
- Unidad condensadora ventilada
- Aislamiento de poliuretano inyectado, libre CFCs, densidad 40 Kg/m³
- Evaporación automática del agua de descarche
- Temperatura de trabajo K1(0+7°C), clase climática CC2(32°C 65%H.R.), según EN16902
- Refrigerante R-600a
- EVRV-370: Puerta cristal, rejilla delantera (Fondo 400mm)
- EVRV-370-C: Puerta cristal, rejilla delantera y canopy (Fondo 400mm)
- EVRB-370: Puerta cristal, escalón (Fondo 500mm)
- EVRB-370-C: Puerta cristal, escalón y canopy (Fondo 500mm)
- EVRV-370-V: Puerta cristal, rejilla delantera (Fondo 510mm)
- EVRV-370-VC: Puerta cristal, rejilla delantera y canopy (Fondo 510mm)

- Exterior and interior in white plastic coated steel
- Designed for beverages and packaged products
- Shelves plastic coated steel wire, adjustable height
- Hermetic compressor high starting torque
- Ventilated evaporator printed on aluminum plate
- Digital temperature control and defrost
- Interior lighting LED
- Ventilated condensing unit
- Insulation: Polyurethane, without CFCs, density 40 Kg / m³
- Automatic evaporation of defrost water
- 65% R.H.), according to EN16902
- Voltage 230V 50/60 Hz
- Refrigerant R-600a
- EVRV-370: Glass door, front grille (Depth 400mm)
- EVRV-370-C: Glass door, front grille and canopy (Depth 400mm)
- EVRB-370: Glass door, step (Depth 500mm)
- EVRB-370-C: Glass door, step and canopy (Depth 500mm)
- EVRV-370-V: Glass door, front grille (Depth 510mm)
- EVRV-370-VC: Glass door, front grille and canopy (Depth 510mm)

- Extérieur et intérieur en acier plastifié de couleur blanche.
- Conçus pour boissons et produits emballés.
- Étagères en fil d'acier plastifié, réglables en hauteur.
- Compresseur hermétique à haut couple de démarrage.
- Évaporateur ventilé imprimé sur plaque d'aluminium
- Contrôle digital de température et du dégivrage.
- Éclairage intérieur LED
- Condensateur ventilé
- Isolation en polyuréthane injecté, densité de 40 Kg / m³, faible GWP et aucun effet ODP.
- Évaporation automatique de l'eau de dégivrage
- Température de fonctionnement K1 (0 + 7 ° C), classe climatique CC2 (32 ° C 65% H.R.), selon EN16902
- Tension monophasique 230V 50/60 Hz
- Gaz réfrigérant R-600a
- EVRV-370 : Porte vitrée, grille avant (Profondeur 400 mm)
- EVRV-370-C : Porte vitrée, grille avant et auvent (Profondeur 400 mm)
- EVRB-370 : Porte vitrée, marche (Profondeur 500 mm)
- EVRB-370-C : Porte, marche et auvent en verre (Profondeur 500 mm)
- EVRV-370-V : Porte vitrée, grille avant (Profondeur 510 mm)
- EVRV-370-VC : Porte vitrée, grille avant et auvent (Profondeur 510 mm)

Modelo Modèle	Largo Length Longueur (mm)	Alto Height Hauteur (mm)	Fondo Depth Profondeur (mm)	Pantalla publicidad Canopy Marquise	Facings lata 33cl 33 cl Facings 33 cl Facings (uds.)	Potencia frig. Frig. Power Puissance frig. (W)	Consumo Nominal Nominal Consumption Consommation Nominale (W)	Volumen bruto Gross volume Volume Brut L	Estantes Shelves Étagères
EV RV-370	370	1815	400	NO	4	205	164	120	4
EV RV-370-C	370	1955	400	1	4	205	168	120	4
EV RVB-370	370	1815	510	NO	4	205	164	175	4
EV RVB-370-C	370	1955	510	1	4	205	168	175	4
EV RV-370-V	370	1815	510	NO	4	205	164	168	4
EV RV-370-VC	370	1955	510	1	4	205	168	168	4

OPCIONES · OPTIONS · OPTIONS

Cerradura lateral	Side Lock	Serrure latérale	35€
Exterior negro	Black exterior	Noir extérieur	180€
Interior negro	230v 60Hz / 115v 60Hz.	230v 60Hz / 115v 60Hz.	180€
Otros Refrigerantes	Other refrigerants	Autres réfrigérants	consultar - consult - consulter
230v 60Hz / 115v 60Hz.	230v 60Hz / 115v 60Hz.	230v 60Hz / 115v 60Hz.	consultar - consult - consulter



Clase Eficiencia Energética (Pag. 9)
Energy Efficiency Class (Pag. 9)

EV RV-370	EV RV-370-C	EV RVB-370	EV RVB-370-C	EV RV-370-V	EV RV-370-VC
1.059 €	1.098 €	1.059 €	1.098 €	1.094 €	1.133 €

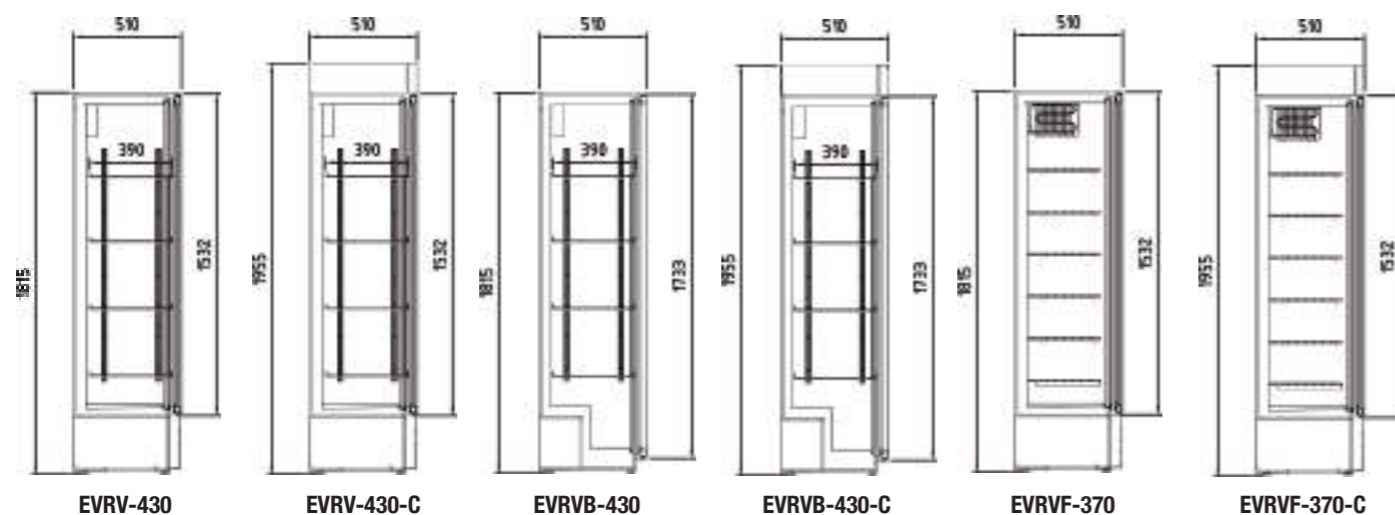

CARACTERÍSTICAS TÉCNICAS	TECHNICAL DATA	CARACTÉRISTIQUES TECHNIQUES
<p>CARACTERÍSTICAS COMUNES</p> <ul style="list-style-type: none"> Exterior e interior en acero plastificado blanco Control digital de temperatura y descarches Iluminación interior LED Unidad condensadora ventilada Tensión monofásica 230V 50 Hz Aislamiento de poliuretano inyectado, libre CFCs, densidad 40 Kg/m³ EV RV / EVRV-C / EVRVB / EVRVB-C Diseñados para bebidas y productos envasados Estantes de alambre de acero plastificado, regulables en altura Compresor hermético alto par de arranque Evaporador ventilado impreso en placa de aluminio Evaporación automática del agua de descarche Temperatura de trabajo K1(0+7°C) clase climática CC2(32°C 65%h.R.), según EN16902 Refrigerante R-600a EV RVF / EVRVF-C Diseñado para conservar producto congelado Evaporación estática 6 estantes fijos (evaporadores) que reparten el frío de manera homogénea en todo el equipo Unidad condensadora libre de mantenimiento Temperatura de trabajo C1(-18°C-16°C), clase climática 4 (30°C, 55HR) Refrigerante R-290 EV RV-430: Puerta cristal, rejilla delantera EV RV-430-C: Puerta cristal, rejilla delantera y canopy EV RB-430: Puerta cristal, escalón EV RB-430-C: Puerta cristal, escalón y canopy EV RVF-430: Puerta cristal, rejilla delantera, mantenimiento congelados EV RVF-430-C: Puerta cristal, rejilla delantera y canopy, mantenimiento de congelados 	<p>FEATURES IN COMMON</p> <ul style="list-style-type: none"> Exterior and interior in white plastic coated steel Digital temperature control and defrost Interior lighting LED Ventilated condensing unit Voltage 230V 50 Hz Insulation: Polyurethane, without CFCs, density 40 Kg / m³ EV RV / EVRV-C / EVRVB / EVRVB-C Designed for beverages and packaged products Shelves plastic coated steel wire, adjustable height Hermetic compressor high starting torque Ventilated evaporator printed on aluminum plate Automatic evaporation of defrost water Working temperature K1 (0 + 7°C), climatic class CC2 (32°C 65% R.H.), according to EN16902 Refrigerant R-600a EV RVF / EVRVF-C Designed to preserve frozen product Static evaporation 6 fixed shelves (evaporators) that distribute the cold evenly throughout the equipment Maintenance-free condensing unit Working temperature C1 (-18°C-16°C), climatic class 4 (30°C, 55HR) Refrigerant R-290 EV RV-430: Glass door, front grille EV RV-430-C: Glass door, front grille and canopy EV RB-430: Glass door, step EV RB-430-C: Glass door, step and canopy EV RVF-430: Glass door, front grille, frozen maintenance EV RVF-430-C: Glass door, front grille and canopy, frozen maintenance 	<p>CARACTÉRISTIQUES COMMUNES</p> <ul style="list-style-type: none"> Extérieur et intérieur en acier plastifié de couleur blanche Contrôle digital de température et du dégivrage. Eclairage intérieur LED Condensateur ventilé Tension monophasique 230V 50 Hz Isolation en polyuréthane injecté, densité de 40 Kg / m³, faible GWP et aucun effet ODP. EV RV / EVRV-C / EVRVB / EVRVB-C Conçus pour boissons et produits emballés. Etagères en fil d'acier plastifié, réglables en hauteur. Compresseur hermétique à haut couple de démarrage. Évaporateur ventilé imprimé sur plaque d'aluminium Condensateur ventilé Évaporation automatique de l'eau de dégivrage Température de fonctionnement K1 (0 + 7 ° C), classe climatique CC2 (32 ° C 65% H.R.), selon EN16902 Gaz réfrigérant R-600a EV RVF / EVRVF-C Conçu pour conserver les produits surgelés Évaporation statique 6 étagères fixes (évaporateurs) qui répartissent le froid uniformément dans tout l'équipement Unité de condensation sans entretien Température de fonctionnement C1 (-18°C-16°C), classe climatique 4 (30°C, 55HR) Réfrigérant R-290 EV RV-430 : Porte vitrée, grille avant EV RV-430-C : Porte vitrée, grille avant et auvent EV RB-430 : Porte vitrée, marche EV RB-430-C : Porte, marche et auvent en verre EV RVF-430 : Porte vitrée, calandre, maintenance gelée EV RVF-430-C : Porte vitrée, calandre et auvent, maintenance gelée

Modelo Model Modèle	Largo Length Longueur (mm)	Alto Height Hauteur (mm)	Fondo Depth Profondeur (mm)	Pantalla publicidad Canopy Marquise	Facings lata 33cl 33 cl Facings 33 cl Facings (uds.)	Potencia frig. Frig. Power Puissance frig. (W)	Consumo Nominal Nominal Consumption Consommation Nominale (W)	Volumen bruto Gross volume Volume Brut L	Estantes Shelves Étagères
EV RV-430	430	1815	510	NO	5	205	164	200	4
EV RV-430-C	430	1955	510	1	5	205	168	200	4
EV RVB-430	430	1815	510	NO	5	205	168	212	4
EV RVB-430-C	430	1955	510	1	5	205	168	212	4
EV RVF-430	430	1815	510	NO	-	385	550	200	6
EV RVF-430-C	430	1955	510	1	-	385	554	200	6

OPCIONES · OPTIONS · OPTIONS			
Cerradura lateral	Side Lock	Serrure latérale	35€
Exterior negro	Black exterior	Noir extérieur	180€
Interior negro	230v 60Hz / 115v 60Hz.	230v 60Hz / 115v 60Hz.	180€
Otros Refrigerantes	Other refrigerants	Autres réfrigérants	consultar - consult - consulter
230v 60Hz / 115v 60Hz.	230v 60Hz / 115v 60Hz.	230v 60Hz / 115v 60Hz.	consultar - consult - consulter



EV RVF-430



EV RV-430
Exterior negro



EV RVF-430
Decoración opcional: consultar
Optional decoration: consult
Décoration option: consulter



EV RV-430
Decoración opcional: consultar
Optional decoration: consult
Décoration option: consulter

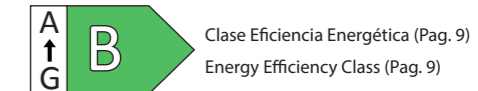

Clase Eficiencia Energética (Pag. 9)
Energy Efficiency Class (Pag. 9)

EV RV-430 1.572 €	EV RV-430-C 1.588 €	EV RVB-430 1.572 €	EV RVB-430-C 1.607 €	EV RVF-430 1.785 €	EV RVF-430-C 1.815 €

Características técnicas y constructivas sujetas a variación sin previo aviso. / We reserve the right to change specifications without prior notice. / Sujet technique et la conception de modifications sans préavis.

Características técnicas y constructivas sujetas a variación sin previo aviso. / We reserve the right to change specifications without prior notice. / Sujet technique et la conception de modifications sans préavis.

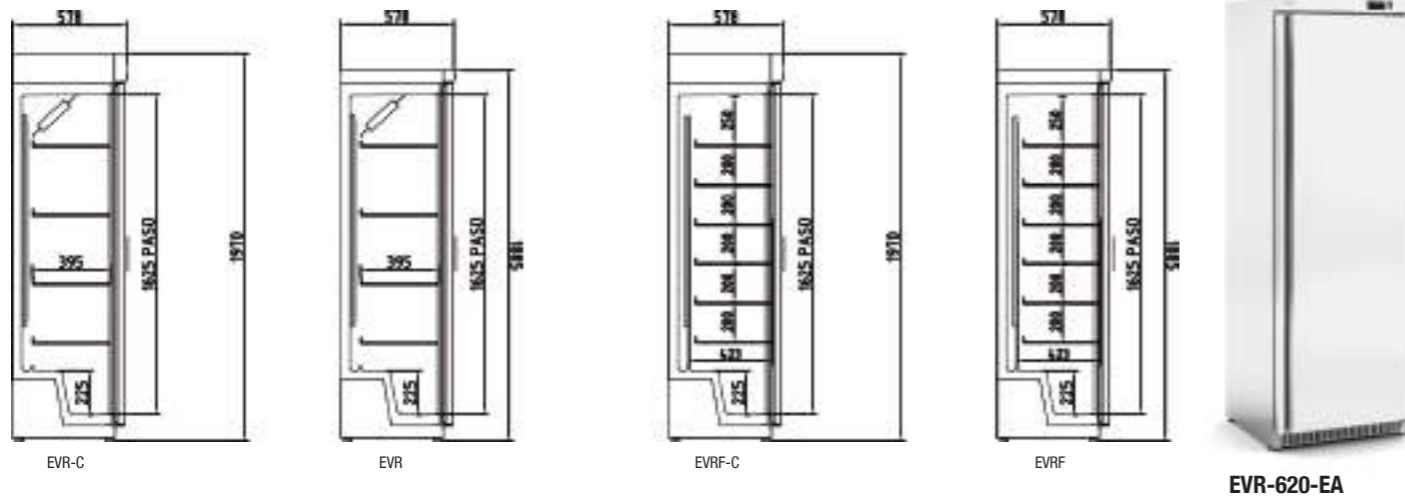

CARACTERÍSTICAS TÉCNICAS	TECHNICAL DATA	CARACTÉRISTIQUES TECHNIQUES
<p>Modelos EVR-C / EVR</p> <ul style="list-style-type: none"> Diseñados para bebidas y productos envasados Estantes de alambre de acero plastificado, regulables en altura Compresor hermético alto par de arranque Evaporador ventilado impreso en placa de aluminio Control digital de temperatura y descarches Iluminación interior LED Unidad condensadora estática libre de mantenimiento Aislamiento de poliuretano inyectado, libre CFCs, densidad 40 Kg/m³ Evaporación automática del agua de descarche Temperatura de trabajo K1(0+7°C), excepto SZ que es K3(-3,5°C+1°C), clase climática CC2(32°C 65% H.R.), según EN16902 Tensión monofásica 230V 50/60 Hz Refrigerante R-600a <p>Modelos EVRF / EVRF-C</p> <ul style="list-style-type: none"> Diseñado para conservar producto congelado Evaporación estática 6 estantes fijos (evaporadores) que reparten el frío de manera homogénea en todo el equipo Temperatura de trabajo C1(-18°C-16°C), clase climática 4 (30°C, 55HR) Refrigerante R-290 Modelo EI: Puerta ciega, exterior inox Modelo EA: Puerta ciega, exterior blanco 	<p>Models EVR-C / EVR</p> <ul style="list-style-type: none"> Designed for beverages and packaged products Shelves plastic coated steel wire, adjustable height Hermetic compressor high starting torque Ventilated evaporator printed on aluminum plate Digital temperature control and defrost Interior lighting LED Static condensing unit, maintenance-free Insulation: Polyurethane, without CFCs, density 40 Kg / m³ Automatic evaporation of defrost water Working temperature K1 (0 + 7°C), climatic class CC2 (32°C 65% R.H.), according to EN16902 Voltage 230V 50/60 Hz Refrigerant R-600a <p>Models EVRF / EVRF-C</p> <ul style="list-style-type: none"> Exterior and interior in white laminated steel Designed to preserve frozen product Static evaporation 6 fixed shelves (evaporators) that distribute the cold evenly throughout the equipment Working temperature C1 (-18°C-16°C), climatic class 4 (30°C, 55HR) Refrigerant R-290 Model EI: Blind door, stainless steel exterior Model EA: Blank door, white exterior 	<p>Modèles EVR-C / EVR</p> <ul style="list-style-type: none"> Conçus pour boissons et produits emballés. Etagères en fil d'acier plastifié, réglables en hauteur. Compresseur hermétique à haut couple de démarrage. Évaporateur ventilé imprimé sur plaque d'aluminium Contrôle digital de température et du dégivrage. Eclairage intérieur LED Unité de condensation statique, sans entretien Isolation en polyuréthane injecté, densité de 40 Kg / m³, faible GWP et aucun effet ODP. Évaporation automatique de l'eau de dégivrage Température de fonctionnement K1 (0 + 7 ° C), sauf SZ qui est K3 (-3,5 ° C + 1 ° C), classe climatique CC2 (32 ° C 65% H.R.), selon EN16902 Tension monophasique 230V 50/60 Hz Gaz réfrigérant R-600a <p>Modèles EVRF / EVRF-C</p> <ul style="list-style-type: none"> Extérieur et intérieur en acier laminé blanc Conçu pour conserver les produits surgelés Évaporation statique 6 étagères fixes (évaporateurs) qui répartissent le froid uniformément dans tout l'équipement Réfrigérant R-290 Modèle EI : Porte aveugle, extérieur en acier inoxydable Modèle EA : Porte pleine, extérieur blanc



EVR-620



EVRV-620-C



Puerta de cristal total - Consultar
Glass door - Consult
Porte en vitre - Consulter



EVRVF-620

Modelo Model Modèle	Largo Length Longueur (mm)	Alto Height Hauteur (mm)	Fondo Depth Profondeur (mm)	Pantalla pulcritud Canopy Marquise	Facings lata 33cl 33 cl Facings 33 cl Facings (uds.)	Capacidad lata 33cl 33cl can capacity Capacité 33cl boîtes (uds.)	Potencia frig. Frig. Power Puissance frig. (W)	Consumo Nominal Nominal Consumption Consommation Nominale (W)	Volumen bruto Gross volume Volume Brut L	Estantes Shelves Étagères
EVR-620-C	620	1970	578	1	7	399	236	189	348	4
EVR-620-C-SZ	620	1970	578	1	7	399	296	236	348	4
EVRV-620	620	1885	578	NO	7	399	236	189	348	4
EVR-620-SZ	620	1885	578	NO	7	399	296	236	348	4
EVRF-620-C	620	1970	578	SI	-	-	231	243	348	6
EVRF-620	620	1885	578	NO	-	-	231	233	348	6

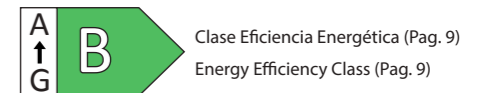

OPCIONES - OPTIONS - OPTIONS			
Cerradura lateral	Side lock	Serrure latérale	35€
Exterior negro	Black exterior	Extérieur noir	180€
Interior negro	Black interior	Intérieur noir	180€
230v 60Hz / 115v 60Hz.	230v 60Hz / 115v 60Hz.	230v 60Hz / 115v 60Hz.	consultar - consult - consulter
Otros Refrigerantes	Other refrigerants	Autres réfrigérants	consultar - consult - consulter

EVR-620-EA	1.333 €	EVRF-620-EA	1.580 €	EVR-620	1.373 €	EVR-620-C	1.395 €
EVR-620-EI	1.960 €	EVRF-620-EI	2.207 €	EVR-620-SZ	1.784 €	EVR-620-C-SZ	1.805 €
				EVR-620	1.972 €	EVRF-620-C	2.009 €

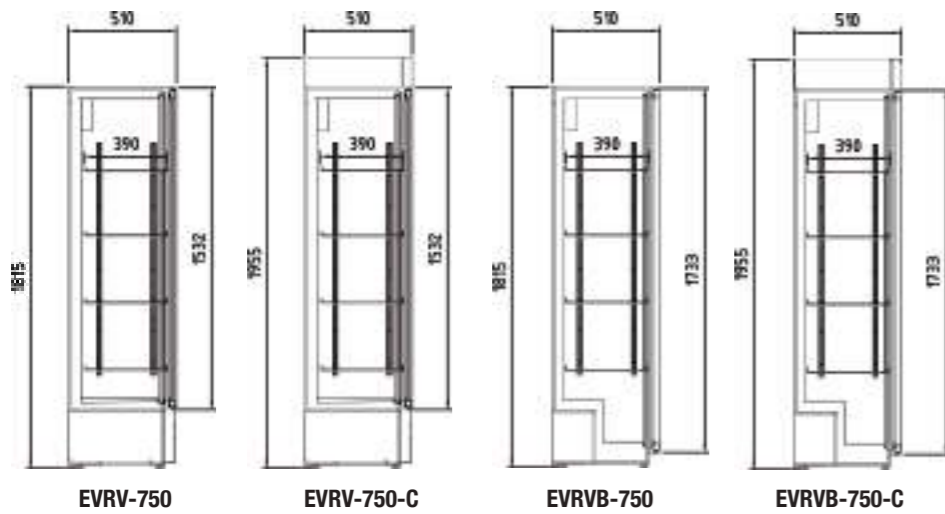

EVRV-750-C

EVRV-750

A
↑
G **C** Clase Eficiencia Energética (Pag. 9)
Energy Efficiency Class (Pag. 9)

CARACTERÍSTICAS TÉCNICAS

- Exterior e interior en acero plastificado blanco
- Diseñados para bebidas y productos envasados
- Estantes de alambre de acero plastificado, regulables en altura
- Compresor hermético alto par de arranque
- Evaporador ventilado impreso en placa de aluminio
- Control digital de temperatura y descarches
- Iluminación interior LED
- Unidad condensadora ventilada
- Aislamiento de poliuretano inyectado, libre CFCs, densidad 40 Kg/m³
- Evaporación automática del agua de descarche
- Temperatura de trabajo K1 (0+7°C), clase climática CC2 (32°C 65% H.R.), según EN16902
- Refrigerante R-600a
- EVRV-750: Puerta cristal, rejilla delantera (Fondo 500mm)
- EVRV-750-C: Puerta cristal, rejilla delantera y canopy (Fondo 500mm)
- EVRB-750: Puerta cristal, escalón (Fondo 500mm)
- EVRB-750-C: Puerta cristal, escalón y canopy (Fondo 500mm)

TECHNICAL DATA

- Exterior and interior in white plastic coated steel
- Designed for beverages and packaged products
- Shelves plastic coated steel wire, adjustable height
- Hermetic compressor high starting torque
- Ventilated evaporator printed on aluminum plate
- Digital temperature control and defrost
- Interior lighting LED
- Ventilated condensing unit
- Insulation: Polyurethane, without CFCs, density 40 Kg / m³
- Automatic evaporation of defrost water
- 65% R.H.), according to EN16902
- Voltage 230V 50/60 Hz
- Refrigerant R-600a
- EVRV-750: Glass door, front grille (Depth 500mm)
- EVRV-750-C: Glass door, front grille and canopy (Depth 500mm)
- EVRB-750: Glass door, step (Depth 500mm)
- EVRB-750-C: Glass door, step and canopy (Depth 500mm)

CARACTÉRISTIQUES TECHNIQUES

- Extérieur et intérieur en acier plastifié de couleur blanche.
- Conçus pour boissons et produits emballés.
- Étagères en fil d'acier plastifié, réglables en hauteur.
- Compresseur hermétique à haut couple de démarrage.
- Évaporateur ventilé imprimé sur plaque d'aluminium
- Contrôle digital de température et du dégivrage.
- Éclairage intérieur LED
- Condensateur ventilé
- Isolation en polyuréthane injecté, densité de 40 Kg / m³, faible GWP et aucun effet ODP.
- Évaporation automatique de l'eau de dégivrage
- Température de fonctionnement K1 (0 + 7 ° C), classe climatique CC2 (32 ° C 65% H.R.), selon EN16902
- Tension monophasique 230V 50/60 Hz
- Gaz réfrigérant R-600a
- EVRV-750 : Porte vitrée, grille avant (Profondeur 500 mm)
- EVRV-750-C : Porte vitrée, grille avant et auvent (Profondeur 500 mm)
- EVRB-750 : Porte vitrée, marche (Profondeur 500 mm)
- EVRB-750-C : Porte, marche et auvent en verre (Profondeur 500 mm)

Modelo Modèle	Largo Length Longueur (mm)	Alto Height Hauteur (mm)	Fondo Depth Profondeur (mm)	Pantalla publicidad Canopy Marquise	Facings lata 33cl 33 cl Facings 33 cl Facings (uds.)	Potencia frig. Frig. Power Puissance frig. (W)	Consumo Nominal Nominal Consumption Consommation Nominale (W)	Volumen bruto Gross volume Volume Brut L	Estantes Shelves Étagères
EV RV-750	750	1815	510	NO	9	215	188	385	4
EV RV-750-C	750	1955	510	1	9	215	198	385	4
EV RVB-750	750	1815	510	NO	9	215	188	409	4
EV RVB-750-C	370	1955	510	1	9	215	198	409	4

OPCIONES · OPTIONS · OPTIONS

Cerradura lateral	Side Lock	Serrure latérale	35€
Exterior negro	Black exterior	Noir extérieur	180€
Interior negro	230v 60Hz / 115v 60Hz.	230v 60Hz / 115v 60Hz.	180€
Otros Refrigerantes	Other refrigerants	Autres réfrigérants	consultar - consult - consulter
230v 60Hz / 115v 60Hz.	230v 60Hz / 115v 60Hz.	230v 60Hz / 115v 60Hz.	consultar - consult - consulter

EV RV-750 1.505 €	EV RV-750-C 1.545 €	EV RVB-750 1.550 €	EV RVB-750-C 1.590 €

Características técnicas y constructivas sujetas a variación sin previo aviso. / We reserve the right to change specifications without prior notice. / Sujet technique et la conception de modifications sans préavis.

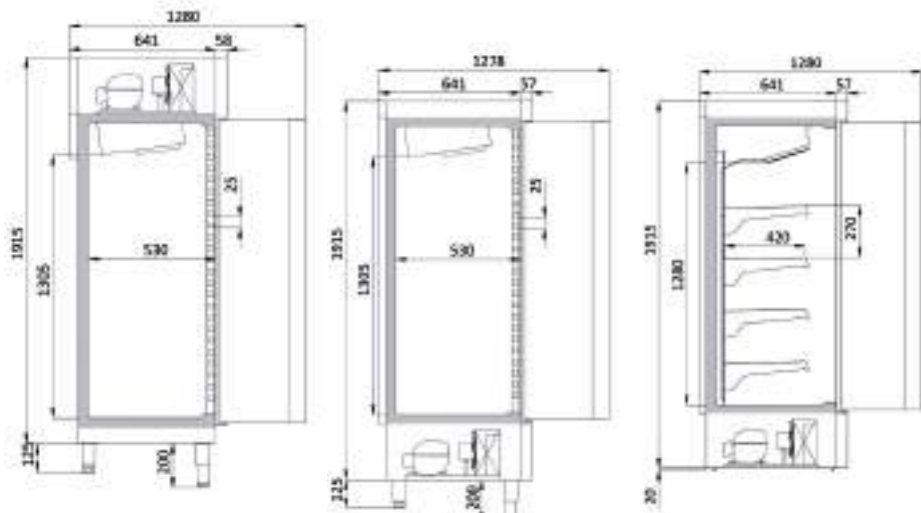

AGPA-125

ARPA / ARPAC-125

ARA / ARAC-125



ARPA-125



AGPA-125

Puertas abatibles
Swing doors
Portes battantes



ARAC-125

CARACTERÍSTICAS TÉCNICAS

- Exterior en acero plastificado blanco
- Interior en acero plastificado blanco
- Estantes de alambre de acero plastificado, dotación 8 unidades (modelos ARPA / AGPA)
- Estantes planos de acero plastificado, dotación 4 unidades (modelos ARA)
- Puertas batientes de aluminio con sistema de cierre automático y burlete magnético (permanece abierta al superar los 90° de apertura)
- Evaporador ventilado pintado en con recubrimiento anticorrosión
- Estantes regulables en altura
- Desescarche natural para modelos refrigeración, desescarche por resistencias para modelos mantenimiento congelados
- Bandeja de evaporación automática
- Control electrónico
- Iluminación LED 24v 6500k en montantes
- Temperatura de producto, según EN-ISO-23953:
 - a. M1: -1°+5°C, apropiado para bebidas, lácteos, delis y embutidos (modelos ARA, ARPA, AGPA)
 - b. L1: -15°-18°C, apropiado para producto congelado (MODELOS ARAC, ARPAC)
- Clase climática 3 (25°C, 60 H.R)

TECHNICAL DATA

- Exterior in white plastic coated steel
- Interior in white plastic coated steel
- Plastic-coated steel wire shelves, supply of 8 units (ARPA / AGPA models)
- Flat plastic-coated steel shelves, supply of 4 units (ARA models)
- Aluminum swing doors with automatic closing system and magnetic weatherstripping (remains open when opening beyond 90°)
- Ventilated evaporator painted in with anti-corrosion coating
- Height adjustable shelves
- Natural defrost for refrigeration models, defrost by resistances for frozen maintenance models
- Automatic evaporation tray
- Electronic control
- 24v 6500k LED lighting on collums
- Product temperature, according to EN-ISO-23953:
 - a. M1: -1°+5°C, suitable for beverages, dairy products, delis and sausages (ARA, ARPA, AGPA models)
 - b. L1: -15°-18°C, appropriate for frozen product (ARAC, ARPAC, MODELS)
- Climate class 3 (25°C, 60 H.R.)

CARACTÉRISTIQUES TECHNIQUES

- Extérieur en acier plastifié blanc
- Intérieur en acier plastifié blanc
- Étagères en fil d'acier plastifié, fourniture de 8 unités (modèles ARPA / AGPA)
- Étagères plates en acier plastifié, fourniture de 4 unités (modèles ARA)
- Portes battantes en aluminium avec système de fermeture automatique et coupe-froid magnétique (reste ouverte lors de l'ouverture au-delà de 90°)
- Évaporateur ventilé peint avec revêtement anti-corrosion
- étagères réglables en hauteur
- Dégivrage naturel pour les modèles de réfrigération, dégivrage par résistances pour les modèles de maintien hors gel
- Plateau d'évaporation automatique
- Contrôle électronique
- Eclairage LED 24v 6500k sur plots
- Température du produit, selon EN-ISO-23953 :
 - pour. M1 : -1°+5°C, adapté aux boissons, produits laitiers, charcuterie et charcuterie (modèles ARA, ARPA, AGPA)
 - b. L1 : -15°-18°C, approprié pour les produits congelés (MODELES ARAC, ARPAC)
- Classe climatique 3 (25°C, 60 H.R.)

Modelo Model Modèle	Largo Length Longueur (mm)	Alto Height Hauteur (mm)	Fondo Depth Profondeur (mm)	Pantalla publicidad Canopy Marquise	Potencia fríg. Frig. Power Puissance frig. (W)	Consumo Nominal Nominal Consumption Consommation Nominale (W)	Volumen bruto Gross volume Volume Brut L	Estantes Shelves Étagères
ARPA-125	1250	2040	700	NO	851	671	1000	8
ARPAC-125	1250	2040	700	NO	833	828	1000	8
AGPA-125	1250	2040	700	1	851	671	1000	8
ARA-125	1250	1935	700	NO	543	434	669	4
ARAC-125	1250	1935	700	NO	833	828	669	4

PVP de opcionales incluidos en equipo, no como repuesto / PVP of options included in the equipment, not as a spare part / PVP d'options incluses dans l'équipement, pas en tant que pièce de rechange

OPCIONES · OPTIONS · OPTIONS

Modelo Model Modèle	Total lacado Laquered total Total laqué	Ruedas Castors Roues
AGPA-125	335 €	146 €
ARPA / ARPAC-125	335 €	146 €
ARA / ARAC-125	335 €	146 €

Características técnicas y constructivas sujetas a variación sin previo aviso. / We reserve the right to change specifications without prior notice. / Sujet technique et la conception de modifications sans préavis.



Clase Eficiencia Energética (Pag. 9)
Energy Efficiency Class (Pag. 9)

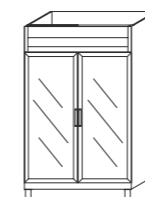

AGPA-125 **2.968 €**

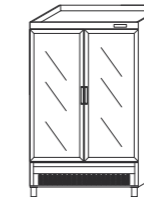

ARPA-125 **2.968 €**
ARPAC-125 **4.300 €**



ARA-125 **3.530 €**
ARAC-125 **4.836 €**

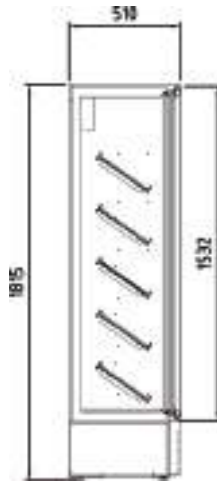

EVRW-370/750



Detalle estante inclinado
Inclined shelf detail
Détail de l'étagère inclinée



DDAW-200



DDAW-400



EVRW-370



EVRW-750

CARACTERÍSTICAS TÉCNICAS

- Exterior e interior en acero plastificado negro (exterior madera opcional)
- Ideales para botella de vino horizontal / vertical / inclinada ajustando dicho estante
- Puertas batientes sin marco y frontal completo de cristal con serigrafía mínima negro RAL 9005 con sistema de cierre automático y burlete magnético (permanece abierta al superar los 90° de apertura)
- Sistema antivibración
- Bajo nivel sonoro
- 5 niveles de estantes con frontal de madera de pino maciza
- Led vertical interior en 3000k continuo, que mejora la visibilidad de las botellas
- Refrigeración ventilada
- Bandeja de evaporación automática
- Control digital de temperatura, incorpora alarma de alta temperatura
- Dos rangos de temperatura disponibles: Vino Tinto (+10°C +18°C) o Vino Blanco, Rosado y Brut (+4°C +8°C)

TECHNICAL DATA

- Exterior and interior in black plastic-coated steel (exterior wood optional)
- Ideal for horizontal / vertical / inclined wine bottle by adjusting said shelf
- Frameless swing doors and full glass front with minimal black RAL 9005 screen printing with automatic closing system and magnetic gasket (remains open when opening more than 90°)
- Anti-vibration system
- Low sound level
- 5 levels of shelves with solid pine wood front
- Interior vertical LED in 3000k continuous, which improves the visibility of the bottles
- Ventilated cooling
- Automatic evaporation tray
- Digital temperature control, incorporates high temperature alarm
- Two temperature ranges available: Red Wine (+10°C +18°C) or White, Rosé and Brut Wine (+4°C +8°C)

CARACTÉRISTIQUES TECHNIQUES

- Extérieur et intérieur en acier plastifié noir (bois extérieur en option)
- Idéal pour bouteille de vin horizontale / verticale / inclinée en ajustant ladite étagère
- Portes battantes sans cadre et façade entièrement vitrée avec sérigraphie noire minimale RAL 9005 avec système de fermeture automatique et coupe-froid magnétique (reste ouvert lors d'une ouverture supérieure à 90°)
- système anti-vibration
- faible niveau sonore
- 5 niveaux d'étagères avec façade en bois de pin massif
- LED verticale intérieure en 3000k continu, ce qui améliore la visibilité des bouteilles
- refroidissement ventilé
- Plateau d'évaporation automatique
- Contrôle numérique de la température, intègre une alarme de haute température
- Deux gammes de température disponibles : Vin Rouge (+10°C +18°C) ou Vin Blanc, Rosé et Brut (+4°C +8°C)

Modelo Model Modèle	Largo Length Longueur (mm)	Alto Height Hauteur (mm)	Fondo Depth Profondeur (mm)	Rango Range Gamme	Potencia frig. Frig. Power Puissance frig. (W)	Consumo Nominal Nominal Consumption Consommation Nominale (W)	Volumen bruto Gross volume Volume Brut L	Estantes Shelves Étagères
DDAW-200	600	900	650	+2°C+ 18°C	304	201	120	2
DDAW-400	600	1545	650	+2°C+ 18°C	460	241	240	4
EVRW-370	370	1815	510	+4°C+ 8°C / +10°C+ 18°C	205	164	168	5
EVRW-430	430	1815	510	+4°C+ 8°C / +10°C+ 18°C	205	168	200	5
EVRW-750	750	1815	510	+4°C+ 8°C / +10°C+ 18°C	205	188	385	5

PVP de opcionales incluidos en equipo, no como repuesto / PVP of options included in the equipment, not as a spare part / PVP d'options incluses dans l'équipement, pas en tant que pièce de rechange

OPCIONES · OPTIONS · OPTIONS

Modelo Model Modèle	Exterior madera (Exterior cerezo) Wood exterior (Cherry exterior) Extérieur en bois (extérieur en cerisier)	Kit 4 ruedas 4 wheels kit Kit 4 roues	Estante adicional X nivel Shelve additional X level Étagère supplémentaire X nivel
DDAW-200	-	98 €	130 €
DDAW-400	-	98 €	130 €
EVRW-370	355 €	98 €	95 €
EVRW-430	355 €	98 €	95 €
EVRW-750	518 €	98 €	139 €

Características técnicas y constructivas sujetas a variación sin previo aviso. / We reserve the right to change specifications without prior notice. / Sujet technique et la conception de modifications sans préavis.



Clase Eficiencia Energética (Pag. 9)
Energy Efficiency Class (Pag. 9)

DDAW-200 1.495 €	DDAW-400 2.410 €	EVRW-370 1.860 €	EVRW-430 1.943 €	EVRW-750 2.598 €

Características técnicas y constructivas sujetas a variación sin previo aviso. / We reserve the right to change specifications without prior notice. / Sujet technique et la conception de modifications sans préavis.

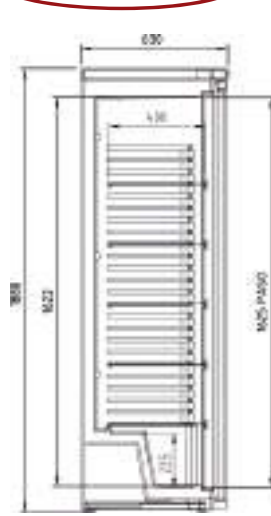

DECW-620

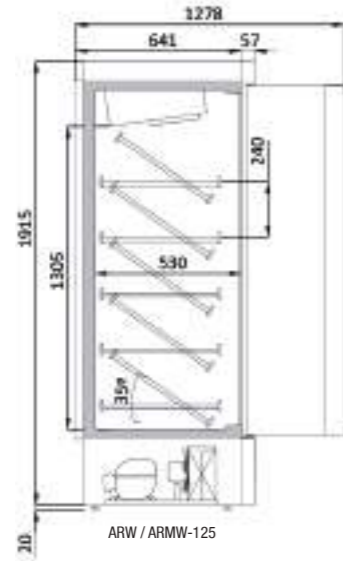

ARW / ARMW-125



DECW-620

Decoración opcional madera
Wood optional decoration
Bois de décoration en option



DEBRW-1302

CARACTERÍSTICAS TÉCNICAS

- Exterior e interior en acero plastificado negro (exterior madera opcional)
- Modelo 125: Ideales para botella de vino horizontal / vertical / inclinada ajustando dicho estante
- Modelo 620: Ideales para botella de vino horizontal / vertical
- Modelo DEBRW: Ideales para botella de vino vertical, cerradura de serie
- Puertas batientes sin marco y frontal completo de cristal con serigrafía mínima negro RAL 9005 con sistema de cierre automático y burlete magnético (permanece abierta al superar los 90° de apertura)
- Sistema antivibración
- Bajo nivel sonoro
- 5 niveles de estantes con frontal de madera de pino maciza
- Estante para botella vertical opcional al mismo precio
- Led vertical interior en 3000k continuo, que mejora la visibilidad de las botellas
- Refrigeración ventilada
- Bandeja de evaporación automática
- Control digital de temperatura, incorpora alarma de alta temperatura
- Dos rangos de temperatura disponibles: Vino Tinto (+10°C +18°C) o Vino Blanco, Rosado y Brut (+4°C +8°C)
- Modelos 125:
 - a) ARMW-125: Dos compartimentos iguales independientes, dos temperaturas diferentes a elegir
 - b) AGMW-125: Dos compartimentos independientes, dos temperaturas diferentes a elegir
 - c) ARW-125: 1 solo compartimento, 1 temperatura posible a elegir (Vino Tinto o Vino Blanco, Rosado y Brut)
- Modelos EBRW/2: Dos departamentos independientes, con regulación de temperatura en rango +2°C + 18°C

TECHNICAL DATA

- Exterior and interior in black plastic-coated steel (exterior wood optional)
- 125 Model: Ideal for horizontal / vertical / inclined wine bottle by adjusting said shelf
- 620 Model: Ideal for horizontal / vertical wine bottle by adjusting said shelf
- DEBRW model: Ideal for vertical wine bottle, standard lock
- Frameless swing doors and full glass front with minimal black RAL 9005 screen printing with automatic closing system and magnetic gasket (remains open when opening more than 90°)
- Anti-vibration system
- Low sound level
- 5 levels of shelves with solid pine wood front
- Optional vertical bottle rack at the same price
- Interior vertical LED in 3000k continuous, which improves the visibility of the bottles
- Ventilated cooling
- Automatic evaporation tray
- Digital temperature control, incorporates high temperature alarm
- Two temperature ranges available: Red Wine (+10°C +18°C) or White, Rosé and Brut Wine (+4°C +8°C)
- 125 models:
 - a) ARMW-125: Two equal independent compartments, two different temperatures to choose
 - b) AGMW-125: Two independent compartments, two different temperatures to choose
 - c) ARW-125: 1 only compartment, 1 possible temperature to choose
- EBRW/2 models: Two independent departments, with temperature regulation in the range +2°C + 18°C

CARACTÉRISTIQUES TECHNIQUES

- Extérieur et intérieur en acier plastifié noir (bois extérieur en option)
- modèle 125 : Idéal pour bouteille de vin horizontale / verticale / inclinée en ajustant ladite étagère
- modèle 620 : Idéal pour bouteille de vin horizontale / verticale en ajustant ladite étagère
- Modèle DEBRW : Idéal pour bouteille de vin verticale, serrure standard
- Portes battantes sans cadre et façade entièrement vitrée avec sérigraphie noire minimale RAL 9005 avec système de fermeture automatique et coupe-froid magnétique (reste ouvert lors d'une ouverture supérieure à 90°)
- système anti-vibration
- faible niveau sonore
- 5 niveaux d'étagères avec façade en bois de pin massif
- Casier à bouteilles vertical en option au même prix
- LED verticale intérieure en 3000k continu, ce qui améliore la visibilité des bouteilles
- refroidissement ventilé
- Plateau d'évaporation automatique
- Contrôle numérique de la température, intègre une alarme de haute température
- Deux gammes de température disponibles : Vin Rouge (+10°C +18°C) ou Vin Blanc, Rosé et Brut (+4°C +8°C)
- 125 modèles :
 - a) ARMW-125 : Deux compartiments indépendants égaux, deux températures différentes au choix
 - b) AGMW-125 : Deux compartiments indépendants, deux températures différentes au choix
 - c) ARW-125 : 1 seul compartiment, 1 température possible au choix
- Modèles EBRW/2 : Deux départements indépendants, avec régulation de température dans la plage +2°C + 18°C



ARMW-125



AGMW-125

Modelo / Model / Modèle	Largo / Length / Longueur (mm)	Alto / Height / Hauteur (mm)	Fondo / Depth / Profondeur (mm)	Rango / Range / Gamme	Capacidad máxima botellas / Max bottle capacity / Capacité maximale de bouteilles (uds.)	Potencia frig. / Frig. Power / Puissance frig. (W)	Consumo Nominal / Nominal Consumption / Consommation Nominale (W)	Volumen bruto / Gross volume / Volume Brut (L)	Estantes / Shelves / Étagères
EVRW-620	620	1885	578	+4°C+ 8°C / +10°C+ 18°C	120	236	189	345	5
ARW-125	1250	1935	700	+4°C+ 8°C / +10°C+ 18°C	252	543	434	1000	10
AGMW-125	1250	1935	700	+4°C+ 8°C / +10°C+ 18°C	216	271+271	213+213	1000	10
ARMW-125	1250	1935	700	+4°C+ 8°C / +10°C+ 18°C	216	271+271	213+213	1000	10
DEBRW-751	680	2055	735	+2°C + 18°C	123	502	260	505	6
DEBRW-1302	1370	2055	735	+2°C + 18°C	246	845	396	1201	12
DEBRW-1302/2	1370	2055	735	+2°C + 18°C	123 + 123	502 + 502	260+260	505 + 505	12

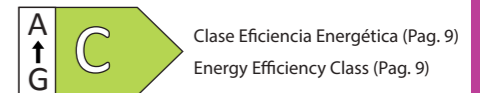

Clase Eficiencia Energética (Pag. 9)
Energy Efficiency Class (Pag. 9)

OPCIONES - OPTIONS - OPTIONS

Modelo / Model / Modèle	Exterior madera 620 (Exterior cerezo) / Wood exterior 620 (Cherry exterior) / Extérieur en bois 620 (extérieur en cerisier)	Exterior madera 125 (Exterior cerezo) / Wood exterior 125 (Cherry exterior) / Extérieur en bois 125 (extérieur en cerisier)	Estante adicional X nivel / Shelve additional X level / Étagère supplémentaire X nivel
DECW-620	355 €	-	95 €
ARW / ARMW / AGMW-125	-	518 €	139 €
DEBRW	-	-	130 €

EVRW-620 1.946 €	DEBRW-751 2.750 €	DEBRW-1302 4.125 € DEBRW-1302/2 4.985 €	ARMW-125-2-E 5.195 € ARW-125-2-E 4.720 €	AGMW-125-2-E 5.195 €

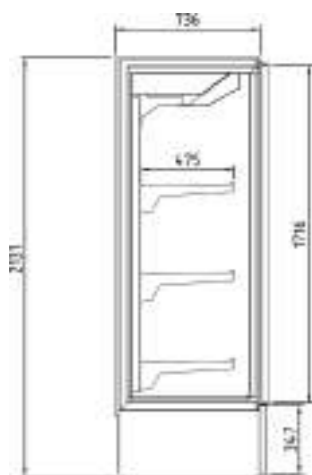

EFIW



Detalle costado ventana

Solo modelos refrigeración
Refrigeration models only
Modèles de réfrigération uniquement



Detalle estante inclinado

Inclined shelf detail
Détail de l'étagère inclinée



EFIW-2R



EFIW-3R

CARACTERÍSTICAS TÉCNICAS

- Exterior e interior en acero plastificado negro (exterior madera opcional)
- Ideales para botella de vino horizontal / vertical ajustando dicho estante, gran capacidad de almacenamiento
- Puertas batientes sin marco y frontal completo de cristal con serigrafía mínima negro RAL 9005 con sistema de cierre automático y burlete magnético (permanece abierta al superar los 90° de apertura)
- Sistema antivibración
- Bajo nivel sonoro
- 3 niveles de estantes con frontal de madera de pino maciza
- Led vertical interior en 3000k continuo, que mejora la visibilidad de las botellas
- Refrigeración ventilada
- Bandeja de evaporación automática
- Control digital de temperatura, incorpora alarma de alta temperatura
- Dos rangos de temperatura disponibles: Vino Tinto (+10°C +18°C) o Vino Blanco, Rosado y Brut (+4°C +8°C)

TECHNICAL DATA

- Exterior and interior in black plastic-coated steel (exterior wood optional)
- Ideal for horizontal / vertical wine bottle by adjusting said shelf, large storage capacity
- Frameless swing doors and full glass front with minimal black RAL 9005 screen printing with automatic closing system and magnetic gasket (remains open when opening more than 90°)
- Anti-vibration system
- Low sound level
- 5 levels of shelves with solid pine wood front
- Interior vertical LED in 3000k continuous, which improves the visibility of the bottles
- Ventilated cooling
- Automatic evaporation tray
- Digital temperature control, incorporates high temperature alarm
- Two temperature ranges available: Red Wine (+10°C +18°C) or White, Rosé and Brut Wine (+4°C +8°C)

CARACTÉRISTIQUES TECHNIQUES

- Extérieur et intérieur en acier plastifié noir (bois extérieur en option)
- Idéal pour bouteille de vin horizontale/verticale en ajustant ladite étagère, grande capacité de stockage
- Portes battantes sans cadre et façade entièrement vitrée avec sérigraphie noire minimale RAL 9005 avec système de fermeture automatique et coupe-froid magnétique (reste ouvert lors d'une ouverture supérieure à 90°)
- système anti-vibration
- faible niveau sonore
- 5 niveaux d'étagères avec façade en bois de pin massif
- LED verticale intérieure en 3000k continu, ce qui améliore la visibilité des bouteilles
- refroidissement ventilé
- Plateau d'évaporation automatique
- Contrôle numérique de la température, intègre une alarme de haute température
- Deux gammes de température disponibles : Vin Rouge (+10°C +18°C) ou Vin Blanc, Rosé et Brut (+4°C +8°C)

Modelo Model Modèle	Largo Length Longueur (mm)	Alto Height Hauteur (mm)	Fondo Depth Profondeur (mm)	Rango Range Gamme	Capacidad máxima botellas Max bottle capacity Capacité maximale de bouteilles (uds.)	Potencia frig. Frig. Power Puissance frig. (W)	Consumo Nominal Nominal Consumption Consommation Nominale (W)	Volumen bruto Gross volume Volume Brut L	Estantes Shelves Étagères
EFIW-1R	642	2131	805	+4°C+ 8°C +10°C+ 18°C	-	555	1132	461	3
EFIW-2R	1285	2131	805	+4°C+ 8°C +10°C+ 18°C	210	1192	1508	1185	3
EFIW-3R	1925	2131	805	+4°C+ 8°C +10°C+ 18°C	300	1528	1945	1690	6



Clase Eficiencia Energética (Pag. 9)
Energy Efficiency Class (Pag. 9)

PVP de opcionales incluidos en equipo, no como repuesto / PVP of options included in the equipment, not as a spare part / PVP d'options incluses dans l'équipement, pas en tant que pièce de rechange

OPCIONES · OPTIONS · OPTIONS

Modelo Model Modèle	Exterior madera EFIW-1R (Exterior cerezo) Wood exterior EFIW-1R (Cherry exterior) Extérieur en bois EFIW-1R (extérieur en cerisier)	Exterior madera EFIW-2R (Exterior cerezo) Wood exterior EFIW-2R (Cherry exterior) Extérieur en bois EFIW-2R (extérieur en cerisier)	Exterior madera EFIW-3R (Exterior cerezo) Wood exterior EFIW-3R (Cherry exterior) Extérieur en bois EFIW-3R (extérieur en cerisier)	Estante adicional X nivel Shelve additional X level Étagère supplémentaire X nivel
EFIW-1R	455 €	-	-	105 €
EFIW-2R	-	780 €	-	212 €
EFIW-3R	-	-	950 €	315 €

Características técnicas y constructivas sujetas a variación sin previo aviso. / We reserve the right to change specifications without prior notice. / Sujet technique et la conception de modifications sans préavis.

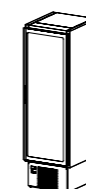

EFIW-1R 3.427 €

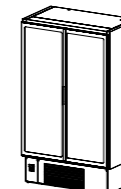

EFIW-2R 4.462 €

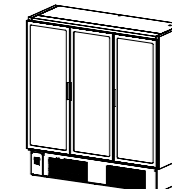

EFIW-3R 5.624 €

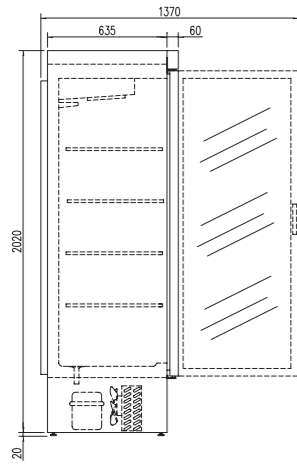

Exterior blanco o negro al mismo precio

White or black exterior at the same price

Extérieur blanc ou noir au même prix



DEBR-1302-BL



DEBR-2003-NB

CARACTERÍSTICAS TÉCNICAS

- DEBR-BL: Exterior en acero plastificado color blanco
- DEBR-NB Exterior en acero plastificado color negro
- Interior en acero plastificado blanco, con aristas curvas y fondo inox embutido
- Puertas de color negro, apertura reversible, con sistema de cierre automático y burlete magnético (permanece abierta al superar los 90° de apertura)
- DEBR: Doble cristal, DEBC: Triple cristal
- Estantes interiores REFORZADOS de alambre en acero plastificado, regulables en altura
- Reguladores de altura, ruedas o patas opcionales
- Cuadro de mandos y rejilla ventilación motor, desmontables
- Unidad condensadora ventilada
- Evaporador sistema tiro forzado, con recubrimiento epoxi anticorrosión
- Aislamiento de poliuretano inyectado, densidad 40 Kg/m³, cero efectos ODP y GWP
- Control digital de temperatura, descarches optimizados, alarma por puerta abierta y alta temperatura de condensación. Eficiente gestión del consumo de energía
- Temperatura de trabajo a 32°C ambiente

TECHNICAL DATA

- DEBR-BL: White color plastic coated exterior
- DEBR-NB: Anthracite color plastic coated exterior
- Interior in white plasticized steel, with curved edges and embedded stainless steel
- Black color doors, with self closing system, blocked opening, magnetic gasket and possibility of changing the opening sense
- DEBR: Double glazed, DEBC: Triple glass
- Shelves made REINFORCED of plasticized steel wire, height adjustable
- Height adjusters, wheels or optional legs
- Control panel and engine ventilation grill, removable
- Fan assisted condenser unit
- Fan assisted evaporator, with epoxi anticorrosion coating
- Evaporator fan stops when door is opened
- Automatic evaporation of defrost water
- 40 Kg/m³ density polyurethane insulation, zero ODP and GWP
- Digital temperature control, optimized defrost, door open and high-temperature condensation alarms. Efficient management of energy consumption Operating temperature 32°C ambient

CARACTÉRISTIQUES TECHNIQUES

- DEBR-BL: extérieur en acier recouvert de plastique blanc
- DEBR-NB: extérieur en acier revêtu de plastique noir
- Double vitrage + LEDS
- Intérieur en acier plastifié blanc, à bords courbes et en acier inoxydable noyé
- Portes noires à ouverture réversible, avec système de fermeture automatique et bande magnétique (reste ouverte même après une ouverture supérieure à 90 °)
- DEBR: Double verre, DEBC: Triple verre
- Étagères intérieures RENFORCÉ en fil de fer en acier plastifié, réglable en hauteur
- Régleurs de hauteur, roues ou pieds en option
- Tableau de commande et grille d'aération du moteur, amovibles
- Unité de condensation ventilée
- Système de tirage forcé de l'évaporateur, avec revêtement époxy anticorrosion
- Isolation en polyuréthane injecté, densité 40 kg / m³, zéro effet ODP et PRP
- Contrôle numérique de la température, dégivrage optimisé, alarme de porte ouverte et température de condensation élevée. Gestion efficace de la consommation d'énergie
- Température de fonctionnement à 32 ° C ambiante

Ver características técnicas en página 196 / See technical data in page 196 / Voir caractéristiques techniques page 196

Modelo Model Modèle	Largo Length Longueur mm	Alto Height Hauteur mm	Fondo Depth Profondeur mm	Rango Range Gamme	Estantes Shelves Étagères	Capacidad Capacity Exposition L	Tensión monofásica Single phase voltage Tension monophasique	Refrigerante Coolant Frigorigène	Potencia Frigorífica Frig Power Puissance Frigorifique W	Consumo Nominal Nominal Consumption Consommation Nominale W
DEBR-751-BL/NB	680	2055	735	-2+8	4	505	230 V - 50 Hz	R-290	502	260
DEBC-751-BL/NB	680	2055	735	-20-15	4	505	230 V - 50 Hz	R-290	606	560
DEBR-1302-BL/NB	1370	2055	735	-2+8	8	1201	230 V - 50 Hz	R-290	845	396
DEBC-1302-BL/NB	1370	2055	735	-20-15	8	1201	230 V - 50 Hz	R-290	907	902
DEBR-2003-BL/NB	2055	2055	735	-2+8	12	1852	230 V - 50 Hz	R-290	1702	943
DEBC-2003-BL/NB	2055	2055	735	-20-15	12	1852	230 V - 50 Hz	R-290	1814	1726

PVP de opcionales incluidos en equipo, no como repuesto / PVP of options included in the equipment, not as a spare part / PVP d'options incluses dans l'équipement, pas en tant que pièce de rechange

OPCIONES - OPTIONS - OPTIONS

Otro color exterior	Other external color	Autre couleur extérieure	consultar - consult - consulter
Porta-precios	Label-holder strip	Étiquettes de prix	6 € x ud
Parrilla adicional	Extra shelf	Grill supplémentaire	33 € x ud
Cerradura puerta cristal	Glass door lock	Serrure à porte en verre	58 € x ud
Set 4 ruedas	4 Castors set	Jeu 4 roulettes	93 € x set
Set 6 ruedas	6 Castors set	Jeu 6 roulettes	139 € x set
Set 4 patas	4 Feet set	Jeu 4 jambes	51 € x set
Set 6 patas	6 Feet set	Jeu 6 jambes	81 € x set
230V 60hz / 115v 60hz	230V 60hz / 115v 60hz	230V 60hz / 115v 60hz	consultar - consult - consulter

Otros gases consultar / Other gases consult / Autres gaz consulter

Características técnicas y constructivas sujetas a variación sin previo aviso. / We reserve the right to change specifications without prior notice. / Sujet technique et la conception de modifications sans préavis.



Clase Eficiencia Energética (Pag. 9)
Energy Efficiency Class (Pag. 9)

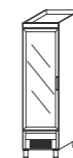

DEBR-751 **2.433 €**
DEBC-751 **3.467 €**



DEBR-1302 **3.486 €**
DEBC-1302 **4.975 €**

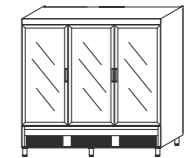

DEBR-2003 **4.540 €**
DEBC-2003 **6.485 €**

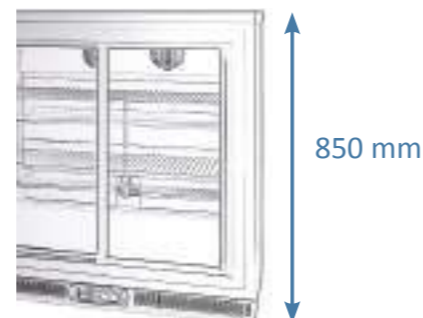
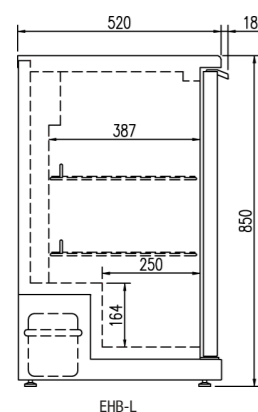

LED



EHB-150-L



EHBS-250-L



LED

CARACTERÍSTICAS TÉCNICAS	TECHNICAL DATA	CARACTÉRISTIQUES TECHNIQUES
<p>EHB-L</p> <ul style="list-style-type: none"> Exterior en acero plastificado negro Interior en acero plastificado gris Doble cristal sobre marco abatible, con cerradura de serie <p>EHBS-L</p> <ul style="list-style-type: none"> Exterior en acero plastificado negro Interior en acero plastificado gris Doble cristal sobre marco deslizable, con cerradura opcional <p>EHB-LI EHBS-LI</p> <ul style="list-style-type: none"> Exterior en acero inoxidable Interior en acero plastificado gris <p>CARACTERÍSTICAS COMUNES</p> <ul style="list-style-type: none"> Diseñados para bebidas y productos envasados Estantes de alambre de acero plastificado, regulables en altura Compresor hermético alto par de arranque Evaporador sistema tiro forzado, con recubrimiento anticorrosión Control digital de temperatura y descargas, eficiente en la gestión del consumo de energía Iluminación interior LED Unidad condensadora estática o ventilada Aislamiento de poliuretano inyectado, densidad 40 Kg/m³, bajo GWP y cero efecto ODP Evaporación automática del agua de descarga Temperatura de trabajo +4°C +8°C a 32°C 65% H.R. ambiente Tensión monofásica 230V 50/60 Hz Refrigerante R600a 	<p>EHB-L</p> <ul style="list-style-type: none"> Black plastic coated steel exterior Interior gray plastic coated steel Double glass on folding frame with lock as standard <p>EHBS-L</p> <ul style="list-style-type: none"> Black plastic coated steel exterior Interior gray plastic coated steel Double glass on sliding frame with optional lock <p>EHB-LI EHBS-LI</p> <ul style="list-style-type: none"> Stainless steel exterior Interior gray plastic coated steel <p>FEATURES IN COMMON</p> <ul style="list-style-type: none"> Designed for beverages and packaged Steel wire shelves adjustable plastic height Hermetic compressor higher starting torque Forced draft evaporator system with anti-corrosion coating Digital temperature control and defrosting, efficient management of energy consumption Interior lighting LED Ventilated condensing unit Isolation of polyurethane, density 40 Kg / m³, low GWP and zero ODP effect Automatic evaporation of defrost water Operating temperature +4 °C +8 °C to 32 °C 65% H.R. ambient Voltage 230V 50/60 Hz Refrigerant R600a 	<p>EHB-L</p> <ul style="list-style-type: none"> Extérieur en acier plastifié noir Intérieur en acier plastifié gris Doble vitrage sur cadre rabattable, avec serrure de série <p>EHBS-L</p> <ul style="list-style-type: none"> Extérieur en acier plastifié noir Intérieur en acier plastifié gris Doble vitrage sur cadre glissant, avec serrure en option <p>EHB-LI EHBS-LI</p> <ul style="list-style-type: none"> Extérieur en acier inoxydable Intérieur en acier plastifié gris <p>CARACTÉRISTIQUES COMMUNES</p> <ul style="list-style-type: none"> Conçues pour des boissons et des produits emballés Étagères en fil de fer en acier plastifié, réglables en hauteur Compresseur hermétique, haut couple de démarrage Contrôle digital de température et dégivrage, efficace dans la gestion de la consommation d'énergie Éclairage intérieur LED Condensateur statique ou ventilé Isolation en polyuréthane injecté, densité 40 Kg/m³, faible GWP et effet nul ODP Évaporation automatique des eaux de dégivrage Température de travail +4°C +8°C à 32°C 65% H.R. ambiante Tension monophasique 230V – 50/60 Hz Réfrigérant R600a



EHBS-250-LI



EHB-250-LI

Modelo Model Modèle	Largo Length Longueur (mm)	Alto Height Hauteur (mm)	Fondo Depth Profondeur (mm)	Potencia frig. Frig. Power Puissance frig. (W)	Consumo Consumption Consommation (W)	Capacidad latas 33cl 33cl can capacity Capacité 33cl boîtes	Capacidad Capacity Exposition L	Estantes Shelves Étagères	Puertas abatibles Swing doors Portes	Puertas correderas Sliding doors Portes coulissantes
EHB-150-L	620	850	520	205	176	150	130	2	1	0
EHB-250-L	925	850	520	418	260	225	200	2	2	0
EHB-350-L	1375	850	520	418	287	320	305	2	3	0
EHBS-250-L	925	850	520	418	260	225	200	2	0	2
EHBS-350-L	1375	850	520	418	287	320	305	2	0	2

PVP de opcionales incluidos en equipo, no como repuesto / PVP of options included in the equipment, not as a spare part / PVP d'options incluses dans l'équipement, pas en tant que pièce de rechange

OPCIONES · OPTIONS · OPTIONS

Estante chapa perforada 150	Perforated sheet shelf 150	Étagère en tôle perforée 150	75 €
Estante chapa perforada 250	Perforated sheet shelf 250	Étagère en tôle perforée 250	88 €
Estante chapa perforada 350	Perforated sheet shelf 350	Étagère en tôle perforée 350	99 €
EHBS cerradura	EHBS lock	EHBS Serrure	58 €
Opción ruedas	Wheels options	Option roues	consultar - consult - consulter
230V 60hz / 115v 60hz	230V 60hz / 115v 60hz	230V 60hz / 115v 60hz	consultar - consult - consulter



Clase Eficiencia Energética (Pag. 9)
Energy Efficiency Class (Pag. 9)



EHB-150-L 1.041 €
EHB-150-LI 1.141 €



EHB-250-L 1.379 €
EHB-250-LI 1.516 €



EHB-350-L 1.679 €
EHB-350-LI 1.889 €



EHBS-250-L 1.393 €
EHBS-250-LI 1.538 €



EHBS-350-L 1.788 €
EHBS-350-LI 1.938 €

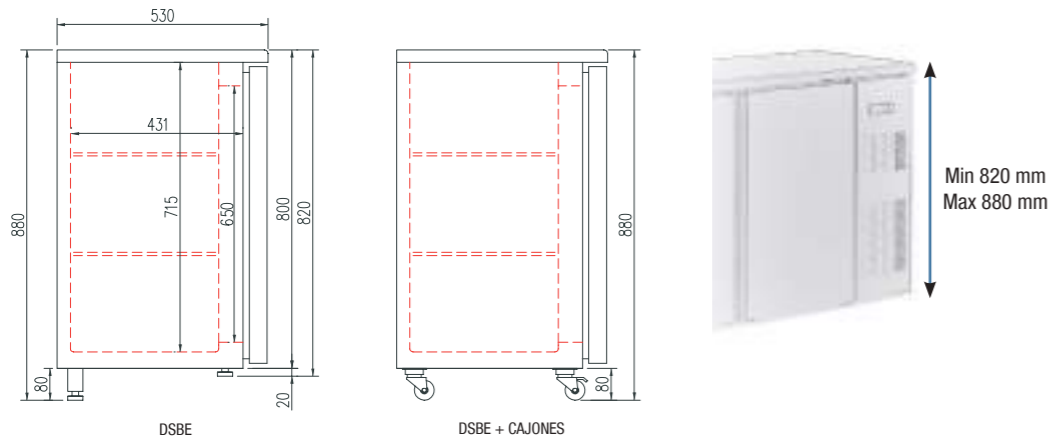

DSBE-250

CARACTERÍSTICAS TÉCNICAS	TECHNICAL DATA	CARACTÉRISTIQUES TECHNIQUES
<p>DSBE / SBEP</p> <ul style="list-style-type: none"> Exterior en acero plastificado negro Interior en acero plastificado gris <p>SBIE / SBIEP</p> <ul style="list-style-type: none"> Exterior en acero inoxidable Interior en acero plastificado gris <p>CARACTERÍSTICAS COMUNES</p> <ul style="list-style-type: none"> Diseñados para bebidas y productos envasados Encastrables Doble cristal sobre marco abatible Estantes de alambre de acero plastificado, regulables en altura Compresor hermético alto par de arranque Descarga por resistencia Evaporador sistema tiro forzado, con recubrimiento epoxi anticorrosión Control digital de temperatura, descargas optimizados, alarma por alta temperatura de condensación. Eficiente gestión del consumo de energía Iluminación interior LEDs Aislamiento de poliuretano inyectado, densidad 40 Kg/m³, bajo GWP y cero efecto ODP Pies regulables, con suplemento para altura 880 mm (incluido) Evaporación automática del agua de descarche Temperatura de trabajo a CC2 a 32°C 65% Tensión monofásica 230V - 50Hz 	<p>DSBE / SBEP</p> <ul style="list-style-type: none"> Black plastic coated steel exterior Interior gray plastic coated steel <p>SBIE / SBIEP</p> <ul style="list-style-type: none"> Stainless steel exterior Interior gray plastic coated steel <p>FEATURES IN COMMON</p> <ul style="list-style-type: none"> Designed for beverages and packaged products Designed for beverages and packaged products "Built-in" designed Double glass on folding frame Steel wire shelves adjustable plastic height Hermetic compressor higher starting torque Defrosting by heating element Forced draft evaporator system with anticorrosion coating Digital temperature control, optimized defrost, high-temperature condensation alarm. Efficient management of energy consumption LEDs interior lighting Isolation of polyurethane, density 40 Kg / m³, zero ODP and GWP Adjustable feet, with supplement for height 880 mm (included) Automatic evaporation of defrost water Operating temperature CC2 a 32°C 65% Voltage 230V - 50Hz 	<p>DSBE / SBEP</p> <ul style="list-style-type: none"> Extérieur en acier plastifié noir Intérieur en acier plastifié gris <p>SBIE / SBIEP</p> <ul style="list-style-type: none"> Extérieur en acier inoxydable Intérieur en acier plastifié gris <p>CARACTÉRISTIQUES COMMUNES</p> <ul style="list-style-type: none"> Conçu pour les boissons et les produits emballés intégré Double vitrage sur cadre pliant Étagères en fil d'acier plastifié réglables en hauteur Compresseur hermétique à couple de démarrage élevé dégivrage à résistance Évaporateur à tirage forcé, avec revêtement époxy anti-corrosion Contrôle numérique de la température, dégivrages optimisés, alarme pour température de condensation élevée. Gestion efficace de la consommation d'énergie Éclairage intérieur à DEL Isolation en polyuréthane injecté, densité 40 Kg/m³, faible GWP et zéro effet ODP Pieds réglables, avec supplément pour hauteur 880 mm (inclus) Évaporation automatique de l'eau de dégivrage Température de fonctionnement à CC2 a 32°C 65% Tension monophasée 230V - 50Hz



DSBE-250

Modelo Model Modèle	Largo Length Longueur (mm)	Alto Height Hauteur (mm)	Fondo Depth Profondeur (mm)	Capacidad latas Cans capacity Capacité canettes (33 cl.)	Capacidad Capacity Exposition L	Estantes Shelves Étagères	Puertas abatibles Swing doors Portes	Refrigerante Coolant Réfrigérant	Potencia frig. Frig. Power Puissance frig. (W)	Consumo Consumption Consommation (W)
DSBE / DSBE-150	1485	820 / 880	530	350	325	4	2	R-290	845	420
DSBE / DSBE-200	2025	820 / 880	530	525	490	6	4	R-290	845	427
DSBE / DSBE-250	2565	820 / 880	530	725	650	8	3	R-290	845	433

230v 60Hz / 115v 60Hz. consultar - consult - consulter

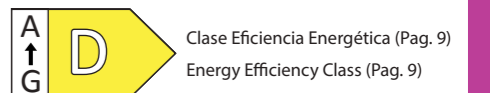

Clase Eficiencia Energética (Pag. 9)
 Energy Efficiency Class (Pag. 9)

PVP de opcionales incluidos en equipo, no como repuesto / PVP of options included in the equipment, not as a spare part / PVP d'options incluses dans l'équipement, pas en tant que pièce de rechange

OPCIONES · OPTIONS · OPTIONS			
Estante chapa inox	SS shelf	étagère en acier inoxydable	79 €
Cerradura puerta de cristal	Glass door lock	Serrure de porte en verre	61 €
Set 4 ruedas	4 Castors set	Jeu 4 roulettes	98 €
Set 6 ruedas	6 Castors set	Jeu 6 roulettes	146 €
230V 60 Hz / 115V 60Hz	230V 60 Hz / 115V 60Hz	230V 60 Hz / 115V 60Hz	Consultar - Consult
Sin motor	No condenser unit	Sans moteur	Consultar - Consult

Características técnicas y constructivas sujetas a variación sin previo aviso. / We reserve the right to change specifications without prior notice. / Sujet technique et la conception de modifications sans préavis.

DSBE-150 2.424 €	DSBE-200 2.966 €	DSBE-250 3.517 €
DSBE-150 2.505 €	DSBE-200 3.069 €	DSBE-250 3.630 €

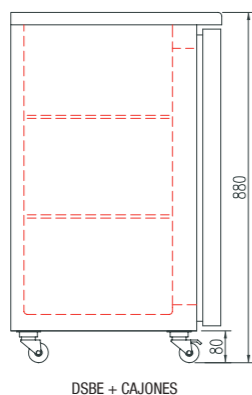
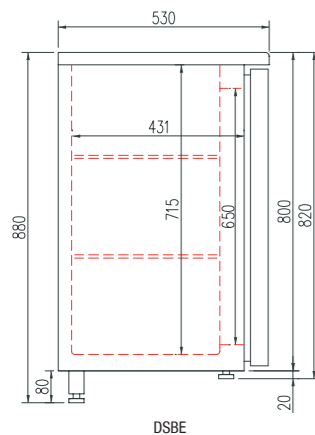

Estantes de chapa inox opcional
Extra stainless steel shelves
Étagères en acier inoxydable en option

Evaporador lateral
Side evaporator
Évaporateur latéral



DSB-250

- 4 Set cajones
- 4 Drawers set
- 4 Ensembles de tiroirs



DSBI-200

- 3 Set cajones
- 3 Drawers set
- 3 Ensembles de tiroirs



Clase Eficiencia Energética (Pag. 9)
Energy Efficiency Class (Pag. 9)

CARACTERÍSTICAS TÉCNICAS

- DSB / DSBP**
- Exterior en acero plastificado negro
 - Interior en acero plastificado gris
- DSBI / DSBI-P**
- Exterior en acero inoxidable
 - Interior en acero plastificado gris
- CARACTERÍSTICAS COMUNES**
- Diseñados para bebidas y productos envasados
 - Encastrables
 - Estantes de alambre de acero plastificado, regulables en altura
 - Compresor hermético alto par de arranque
 - Evaporador sistema tiro forzado, con recubrimiento epoxi anticorrosión
 - Descarga por resistencia
 - Control digital de temperatura, descargas optimizados, alarma por alta temperatura de condensación. Eficiente gestión del consumo de energía
 - Aislamiento de poliuretano inyectado, densidad 40 Kg/m³, bajo GWP y cero efecto ODP
 - Pies regulables, con suplemento para altura 880 mm (incluido)
 - Evaporación automática del agua de descarche
 - Temperatura de trabajo CC2 a 32°C 65%
 - Tensión monofásica 230V - 50Hz

TECHNICAL DATA

- DSB / DSBP**
- Black plastic coated steel exterior
 - Interior gray plastic coated steel
- DSBI / DSBI-P**
- Stainless steel exterior
 - Interior gray plastic coated steel
- FEATURES IN COMMON**
- Designed for beverages and packaged
 - "Built-in" designed
 - Steel wire shelves adjustable plastic height
 - Hermetic compressor higher starting torque
 - Defrosting by heating element
 - Forced draft evaporator system with anticorrosion coating
 - Digital temperature control, optimized defrost, high-temperature condensation alarm. Efficient management of energy consumption
 - Isolation of polyurethane, density 40 Kg / m³, zero ODP and GWP
 - Adjustable feet, with supplement for height 880 mm (included)
 - Automatic evaporation of defrost water
 - Operating temperature CC2 a 32°C 65%
 - Voltage 230V - 50Hz

CARACTÉRISTIQUES TECHNIQUES

- DSB / DSBP**
- Extérieur en acier plastifié noir
 - Intérieur en acier plastifié gris
- DSBI / DSBI-P**
- Extérieur en acier inoxydable
 - Intérieur en acier plastifié gris
- CARACTÉRISTIQUES COMMUNES**
- Conçu pour les boissons et les produits emballés
 - intégré
 - Étagères en fil d'acier plastifié réglables en hauteur
 - Compresseur hermétique à couple de démarrage élevé
 - Évaporateur à tirage forcé, avec revêtement époxy anti-corrosion
 - Dégivrage par résistance
 - Contrôle numérique de la température, dégivrages optimisés, alarme pour température de condensation élevée. Gestion efficace de la consommation d'énergie
 - Isolation en polyuréthane injecté, densité 40 Kg/m³, faible GWP et zéro effet ODP
 - Pieds réglables, avec supplément pour hauteur 880 mm (inclus)
 - Evaporation automatique de l'eau de dégivrage
 - Température de fonctionnement à CC2 a 32°C 65%
 - Tension monophasée 230V - 50Hz

Modelo Model Modèle	Largo Length Longueur (mm)	Alto Height Hauteur (mm)	Fondo Depth Profondeur (mm)	Capacidad latas Cans capacity Capacité canettes (33 cl.)	Capacidad Capacity Capacité Exposition L	Estantes Shelves Étagères	Puertas abatibles Swing doors Portes	Refrigerante Coolant Réfrigérant	Potencia frig. Frig. Power Puissance frig. (W)	Consumo Consumption Consommation (W)
DSB / DSBI-150	1485	820 / 880	530	350	325	4	2	R-290	613	300
DSB / DSBI-200	2025	820 / 880	530	525	490	6	3	R-290	678	310
DSB / DSBI-250	2565	820 / 880	530	725	650	8	4	R-290	743	320

230v 60Hz / 115v 60Hz. consultar - consult - consulter

PVP de opcionales incluidos en equipo, no como repuesto / PVP of options included in the equipment, not as a spare part / PVP d'options incluses dans l'équipement, pas en tant que pièce de rechange

OPCIONES · OPTIONS · OPTIONS

Separador interior cajón	Interior drawer divider	Séparateur de tiroir intérieur	16 €
Estante chapa inox	SS shelf	étagère en acier inoxydable	79 €
Cajonera doble inox	double inox chest of drawers	double tiroir en acier inoxydable	512 €
Cajonera doble plast negro	double black plast chest of drawers	commode double en plast noir	476 €
Cajonera triple inox	triple SS chest of drawers	triple tiroir en acier inoxydable	742 €
Cajonera triple plast negro	black triple plast chest of drawers	commode triple plast noir	703 €
Set 4 ruedas	4 Castors set	Jeu 4 roulettes	98 €
Set 6 ruedas	6 Castors set	Jeu 6 roulettes	146 €
Cerradura puerta ciega	Blind door lock	Serrure de porte aveugle	25 €
230V 60 Hz / 115V 60Hz	230V 60 Hz / 115V 60Hz	230V 60 Hz / 115V 60Hz	Consultar - Consult
Sin motor	No condenser unit	Sans moteur	Consultar - Consult

Características técnicas y constructivas sujetas a variación sin previo aviso. / We reserve the right to change specifications without prior notice. / Sujet technique et la conception de modifications sans préavis.

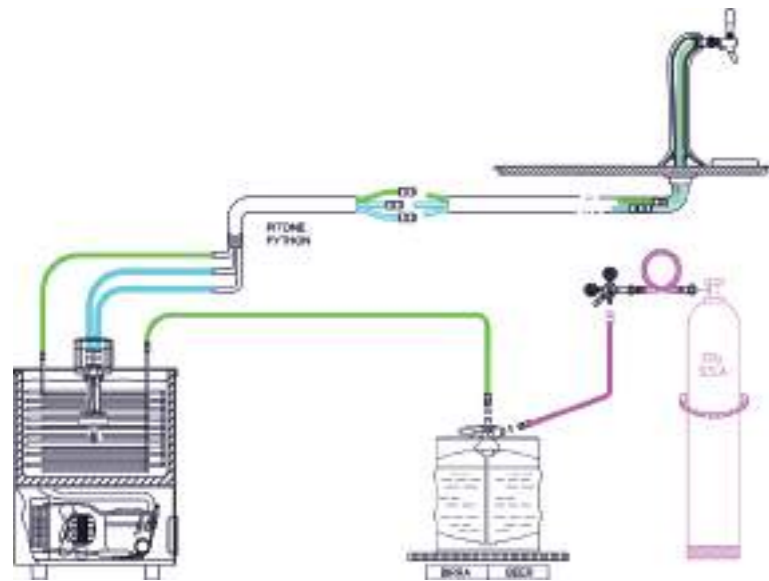

EJEMPLO INSTALACION / INSTALLATION EXAMPLE / EXEMPLE D'INSTALLATION



V-100

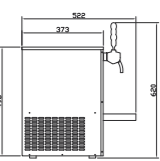

VP-30+GRIFO

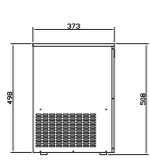

V-30

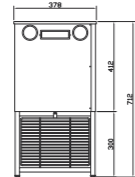

V-50

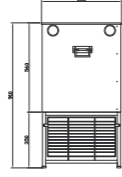

V-100

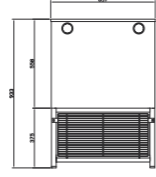

V-200

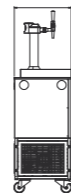

VP-100

CARACTERÍSTICAS TÉCNICAS

- Exterior en acero inox
- Cuba interior de fibra de poliéster
- Serpentin evaporador de tubo de cobre
- Serpentin producido en acero inox AISI-304 18/10
- Bomba agitador interior
- Equipo compresor alto par de arranque
- Control electrónico espesor de hielo
- Rejilla para ventilación en plástico o metálicas
- VP incluye columna, bandeja, grifo y ruedas.

TECHNICAL DATA

- Exterior in stainless steel
- Interior in polyester fibre
- Copper coil for evaporator
- Stainless steel internal coil for liquid coolant
- Internal pump agitator
- Ventilated hermetic compressor set
- Electronic equipment for ice thickness control
- Plastic or metal ventilation grilles
- VP included tray, faucet, column and wheels

CARACTÉRISTIQUES TECHNIQUES

- Extérieur en acier inoxydable
- Cuve intérieure en fibre de polyester
- Serpentin évaporateur en tube de cuivre.
- Serpentin produit en acier inoxydable AISI 304 18/10
- Agitateur-Pompe interne.
- Compresseur à haut couple de démarrage
- Contrôle électronique de l'épaisseur de la glace.
- Grille de ventilation en plastique ou métal.
- VP comprend un plateau colonne, robinet et roues



Modelo	Largo	Alto	Fondo	Volumen cuba	Peso Neto	Potencia frig.	Cuba reserva de hielo	Compresor rendimiento evaporación -10°C	Serpentines	Refrig.	Consumo nominal
Model	Length	Height	Depth	Water Tank	Net Weight	Frig. Power	ice cask capacity	Compressor ouput (W) evaporation -10°C	Inox coils	Coolant	Nominal Power
Modèle	Longueur	Hauteur	Profondeur	Cuve d'eau	Poid Net	Puissance frig.	Cuba livre de glace	Évaporation compresseur de performance	Bobine	Frigorigène	Consommation nominale
	mm.	mm.	mm.	(l)	(Kg)	(W)	Kg	W			(W)
V-30	335	505	373	13,5	25	176	8	198	1x12 m	R-600a	192
V-50	379	712	379	25,5	34	484	16	337	1x16 m	R-290	337
V-100	430	768	430	42	36	583	21	392	1x26 m	R-290	392
V-200	502	900	502	72	44	1012	40	655	1x32 m	R-290	655
VP-100	430	1367	430	42	36	583	21	392	1x26 m	R-290	392

OPCIONES · OPTIONS · OPTIONS

Manorreductor 1P + 1P	Pressure regulator 1P + 1P	Regulateur de pression 1P + 1P	consultar - consult - consulter
Otros Refrigerantes	Other refrigerants	Autres réfrigérants	consultar - consult - consulter



VP-30 **1.102 €**

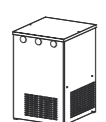

V-30 **1.056 €**



V-50 **1.219 €**

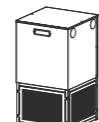

V-100 **1.429 €**

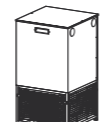

V-200 **1.769 €**



VP-100 **1.960 €**

Características técnicas y constructivas sujetas a variación sin previo aviso. / We reserve the right to change specifications without prior notice. / Sujet technique et la conception de modifications sans préavis.



V-200



VP-100



H-100

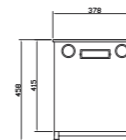

H-50

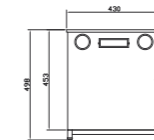

H-100

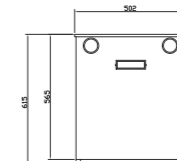

H-200

CARACTERÍSTICAS TÉCNICAS

- Exterior en acero inox AISI-304 18/1
- Cuba interior de fibra de poliéster
- Serpentin evaporador de tubo de cobre
- Serpentin producido en acero inox AISI-304 18/10
- Bomba agitador interior
- Equipo compresor alto par de arranque
- Control electrónico espesor de hielo
- Rejilla para ventilación en plástico o metálicas

TECHNICAL DATA

- Exterior in stainless steel AISI-304 18/10
- Interior in polyester fibre
- Copper coil for evaporator
- Stainless steel internal coil for liquid coolant
- Internal pump agitator
- Ventilated hermetic compressor set
- Electronic equipment for ice thickness control
- Plastic or metal ventilation grilles

CARACTÉRISTIQUES TECHNIQUES

- Extérieur en acier inoxydable AISI 304 18/10,
- Cuve intérieure en fibre de polyester
- Serpentin évaporateur en tube de cuivre.
- Serpentin produit en acier inoxydable AISI 304 18/10
- Agitateur-Pompe interne.
- Compresseur à haut couple de démarrage
- Contrôle électronique de l'épaisseur de la glace.
- Grille de ventilation en plastique ou métal.



Modelo	Largo	Alto	Fondo	Volumen cuba	Peso Neto	Potencia frig.	Cuba reserva de hielo	Compresor rendimiento evaporación -10°C	Serpentines	Refrig.	Consumo nominal
Model	Length	Height	Depth	Water Tank	Net Weight	Frig. Power	ice cask capacity	Compressor ouput (W) evaporation -10°C	Inox coils	Coolant	Nominal Power
Modèle	Longueur	Hauteur	Profondeur	Cuve d'eau	Poid Net	Puissance frig.	Cuba livre de glace	Évaporation compresseur de performance	Bobine	Frigorigène	Consommation nominale
	mm.	mm.	mm.	(l)	(Kg)	(W)	Kg	W			(W)
H-50	745	460	378	25,5	34	484	16	484	1x16 m	R-290	337
H-100	795	500	430	42	36	583	21	583	1x26 m	R-290	392
H-200	860	580	500	72	44	1012	40	1012	1x32 m	R-290	655

OPCIONES · OPTIONS · OPTIONS

Manorreductor 1P + 1P	Pressure regulator 1P + 1P	Regulateur de pression 1P + 1P	consultar - consult - consulter
Otros Refrigerantes	Other refrigerants	Autres réfrigérants	consultar - consult - consulter

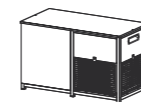

H-50 **1.232 €**

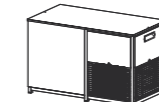

H-100 **1.490 €**

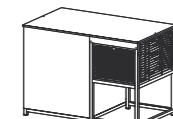

H-200 **1.837 €**

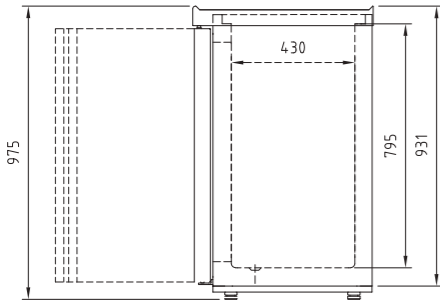

DEB-150
Trasera acristalada
Rear glass
Vitre arrière



DEB-150

LED

CARACTERÍSTICAS TÉCNICAS

- Exterior en acero inox AISI-304 18/10, excepto el respaldo
- Interior en acero inox AISI-304 18/10, con aristas curvas y fondo embutido
- Refuerzo para apoyo y deslizado de los barriles de 50 o 30 litros
- Puertas de apertura reversible, con sistema de cierre automático y burlete magnético (permanece abierta al superar los 90° de apertura)
- DB: puerta inox y contrapuerta embutida
- DEB: puerta de cristal doble con cámara de vacío y luz interior
- Encimera de acero inox AISI-304 18/10 con perímetro vierte-aguas
- Chasis en tubo de acero inox y patas regulables
- Evaporador sistema tiro forzado, con recubrimiento anticorrosión
- Aislamiento de poliuretano inyectado, densidad 40 Kg/m³, bajo GWP y cero efecto ODP
- Control digital de temperatura y descargas, eficiente en la gestión del consumo de energía
- Temperatura de trabajo -2°C +8°C a 32°C 65% H.R. ambiente

TECHNICAL DATA

- AISI-304 18/10 stainless steel exterior, except the rear side
- AISI-304 18/10 stainless steel interior, stamped bottom and rounded corners
- Reinforced base to drop and slide the barrels (50 or 30 liters)
- Doors with self closing system, blocked opening, magnetic gasket and possibility of changing the opening sense
- DB: stainless steel door, rear-door by stamped steel
- DEB: double glazed door and interior lighting
- Worktop in stainless steel AISI-304 18/10 with perimeter-water poured
- AISI -304 18/10 base and legs
- Fan assisted evaporator, with anticorrosion coating.
- 40 Kg/m³ density polyurethane insulation, low GWP and zero ODP effect
- Energy efficient digital controller of temperature and defrosts
- Operating temperature -2°C +8°C , 32°C 65% H.R. ambient

CARACTÉRISTIQUES TECHNIQUES

- Extérieur en acier inoxydable AISI-304 18/10, sauf soutien
- Intérieur en acier inoxydable AISI-304 18/10, avec des arêtes courbées et de fond emboutie
- Renfort pour le support et la glisse des barils de 50 ou 30 litres
- Portes à ouverture réversible, avec système de fermeture automatique et bourrelet magnétique (ouverture de la porte maintenue en angle droit)
- DB : porte en inox et contre-porte emboutie
- DEB : double porte vitrée et lumière intérieure
- Plan de travail en inox AISI-304 18/10 avec périmètre de l'eau à verser
- Châssis en tube d'acier inoxydable et pieds réglables
- Évaporateur avec un système d'évacuation forcée (qui comprend ventilateurs à tirage aspiré), avec revêtement anticorrosion.
- Isolation en polyuréthane injecté, densité 40kg/m3, GWP faible et effet nul ODP
- Contrôle digital de température et dégivrage, efficace pour la gestion de la consommation d'énergie
- Température de travail -2°C +8°C à 32°C 65% H.R. ambiante

Modelo Model Modèle	Largo Length Longueur mm.	Alto Height Hauteur mm.	Fondo Depth Profondeur mm.	Capacidad Capacity Exposition	Puertas cristal Glass doors Portes vitrés	Rango Range Gamme	Puertas inox Doors Portes	Potencia Frig. Frig Power Puissance Frig. W	Consumo Nominal Nominal Consumption Consommation Nominale W
DB-100	1110	975	600	2	-	+5°C+8°C	2	845	340
DB-150	1600	975	600	3	-	+5°C+8°C	3	845	340
DB-200	2120	975	600	4	-	+5°C+8°C	4	845	340
DEB-100	1100	975	600	2	2	+5°C+8°C	-	845	350
DEB-150	1600	975	600	3	3	+5°C+8°C	-	845	356
DEB-200	2120	975	600	4	4	+5°C+8°C	-	845	362

OPCIONES · OPTIONS · OPTIONS

Otros Refrigerantes	Other refrigerants	Autres réfrigérants	consultar - consult - consulter
---------------------	--------------------	---------------------	---------------------------------

PVP de opcionales incluidos en equipo, no como repuesto / PVP of options included in the equipment, not as a spare part / PVP d'options incluses dans l'équipement, pas en tant que pièce de rechange

OPCIONES · OPTIONS · OPTIONS

	TRASERA CRISTAL · REAR GLASS · ARRIÈRE EN VERRE	TRASERA INOX · REAR STAINLESS STEEL · ARRIÈRE EN ACIER	PREINSTALACION · PREINSTALLATION · PREINSTALLATION
DEB-100	237 €	98 €	consultar - consult - consulter
DEB-150	373 €	127 €	consultar - consult - consulter
DEB-200	475 €	154 €	consultar - consult - consulter



Características técnicas y constructivas sujetas a variación sin previo aviso. / We reserve the right to change specifications without prior notice. / Sujet technique et la conception de modifications sans préavis.



DB-150

DB-100	DB-150	DB-200	DEB-100	DEB-150	DEB-200
3.621 €	4.332 €	4.975 €	3.947 €	4.790 €	5.572 €

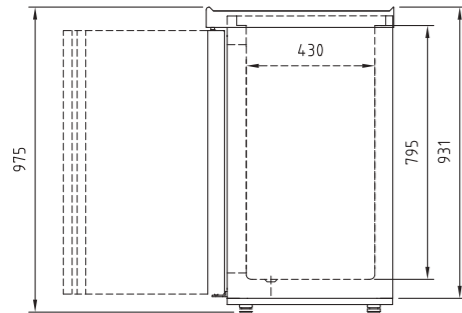

CARACTERÍSTICAS TÉCNICAS

- Exterior en acero inox AISI-304 18/10, excepto el respaldo
- Interior en acero inox AISI-304 18/10, con aristas curvas y fondo embutido
- Refuerzo para apoyo y deslizado de los barriles de 50 o 30 litros
- Puertas de apertura reversible, con sistema de cierre automático y burlete magnético (permanece abierta al superar los 90° de apertura)
- DBP: puerta inox y contrapuerta embutida
- DEBP: puerta de cristal doble con cámara de vacío y luz interior
- Encimera de acero inox AISI-304 18/10 con perímetro vierte-aguas
- Chasis en tubo de acero inox y patas regulables
- Evaporador sistema tiro forzado, con recubrimiento anticorrosión
- Aislamiento de poliuretano inyectado, densidad 40 Kg/m³, bajo GWP y cero efecto ODP
- Control digital de temperatura y descargas, eficiente en la gestión del consumo de energía
- Temperatura de trabajo -2°C +8°C a 32°C ambiente

TECHNICAL DATA

- AISI-304 18/10 stainless steel exterior, except the rear side
- AISI-304 18/10 stainless steel interior, stamped bottom and rounded corners
- Reinforced base to drop and slide the barrels (50 or 30 liters)
- Doors with self closing system, blocked opening, magnetic gasket and possibility of changing the opening sense
- DBP: stainless steel door, rear-door by stamped steel
- DEBP: double glazed door and interior lighting
- Worktop in stainless steel AISI-304 18/10 with perimeter-water poured
- AISI -304 18/10 base and legs
- Fan assisted evaporator, with anticorrosion coating.
- 40 Kg/m³ density polyurethane insulation, low GWP and zero ODP effect
- Energy efficient digital controller of temperature and defrosts
- Operating temperature -2°C +8°C , 32°C ambient

CARACTÉRISTIQUES TECHNIQUES

- Extérieur en acier inoxydable AISI-304 18/10, sauf soutien
- Intérieur en acier inoxydable AISI-304 18/10, avec des arêtes courbées et de fond emboutie
- Renfort pour le support et la glisse des barils de 50 ou 30 litres
- Portes à ouverture réversible, avec système de fermeture automatique et bourrelet magnétique (ouverture de la porte maintenue en angle droit)
- DBP : porte en inox et contre-porte emboutie
- DEBP : double porte vitrée et lumière intérieure
- Plan de travail en inox AISI-304 18/10 avec périmètre de l'eau à verser
- Châssis en tube d'acier inoxydable et pieds réglables
- Évaporateur avec un système d'évacuation forcée (qui comprend ventilateurs à tirage aspiré), avec revêtement anticorrosion.
- Isolation en polyuréthane injecté, densité 40kg/m³, GWP faible et effet nul ODP
- Contrôle digital de température et dégivrage, efficace pour la gestion de la consommation d'énergie
- Température de travail -2°C +8°C à 32°C ambiante



DBP-220



LED



DBP-170
 Vista trasera / Rear view / Vue arrière
 TRASERA CRISTAL OPCIONAL
 OPTIONAL REAR GLASS
 OPTION ARRIÈRE EN VERRE

Modelo Model Modèle	Largo Length Longueur mm.	Alto Height Hauteur mm.	Fondo Depth Profondeur mm.	Capacidad Capacity Capacité Exposition	Puertas cristal Glass doors Portes vitrés	Rango Range Gamme	Puertas inox Doors Portes	Potencia Frig. Frig Power Puissance Frig. W
DB / DBV-120	1195	975	600	2	-	+5°C+8°C	2	485
DB / DBV-170	1720	975	600	3	-	+5°C+8°C	3	485
DB / DBV-220	2245	975	600	4	-	+5°C+8°C	4	485
DEB / DEBV-120	1195	975	600	2	2	+5°C+8°C	-	485
DEB / DEBV-170	1720	975	600	3	3	+5°C+8°C	-	485
DEB / DEBV-220	2245	975	600	4	4	+5°C+8°C	-	485

PVP de opcionales incluidos en equipo, no como repuesto / PVP of options included in the equipment, not as a spare part / PVP d'options incluses dans l'équipement, pas en tant que pièce de rechange

OPCIONES · OPTIONS · OPTIONS

1 Grifo cerveza	1 Beer tower	1 Robinet à bière	+360 €
2 Grifos cerveza	2 Beer towers	2 Robinet à bière	+640 €
3 Grifos cerveza	3 Beer towers	3 Robinet à bière	+920 €
TRASERAS CRISTAL · REAR GLASS · ARRIÈRE EN VERRE			
DEB-100			165 €
DEB-150			260 €
DEB-200			340 €

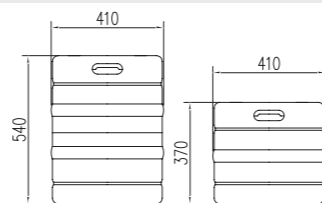

Características técnicas y constructivas sujetas a variación sin previo aviso. / We reserve the right to change specifications without prior notice. / Sujet technique et la conception de modifications sans préavis.

DBP-120 2.743 €	DBP-170 3.446 €	DBP-220 4.057 €	DEBP-120 3.052 €	DEBP-170 3.879 €	DEBP-220 4.625 €

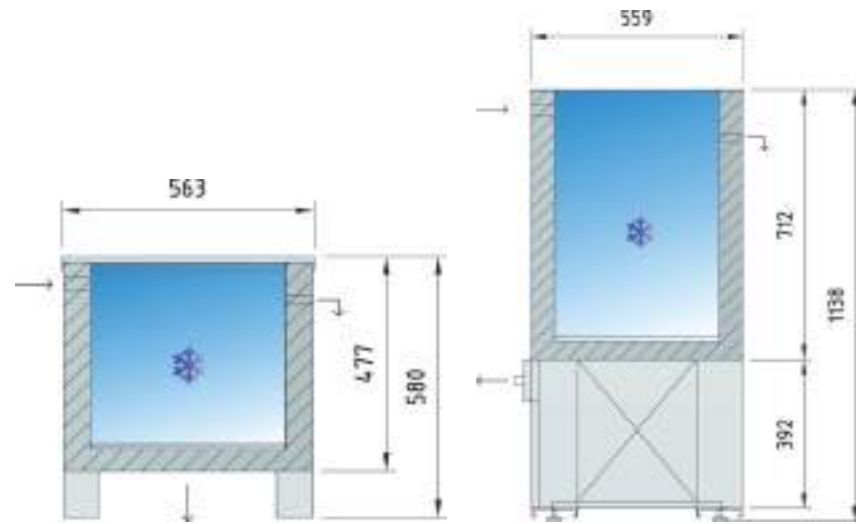

EAP-175V



EAP-100H

CARACTERÍSTICAS TÉCNICAS

- EAPI Exterior en acero inox AISI 304.
- EAP Exterior en acero plastificado blanco.
- Serpentin evaporador interior en acero inox AISI 304.
- Aislamiento en poliuretano inyectado, densidad 40kg/m3 y grosor 60mm.
- Llenado automático por boya, diametro 1/2"
- Agitador de agua interior
- Control digital electrónico.
- Encimera desmontable.
- Rebosadero de seguridad diametro 3/4".

TECHNICAL DATA

- EAPI Exterior in AISI 304 stainless steel.
- EAP white plastic coated steel exterior.
- AISI 304 stainless steel Internal evaporator coil
- Injected polyurethane insulation without CFCs density 40kg/m3 with 60mm thickness.
- Automatic fill, float system, 1/2" diameter
- Interior water shaker
- Digital electronic control.
- "Trop plein" security, diameter 3/4".

CARACTÉRISTIQUES TECHNIQUES

- EAPI Extérieur en acier inoxydable AISI 304.
- EAP plastique blanc revêtu extérieur en acier.
- Évaporateur en acier inox AISI 304
- Isolation en polyuréthane injecté, sans CFCs avec densité 40kg/m3 et 60mm épaisseur.
- Remplissage automatique à flotteur, diamètre 1/2" Agitateur d'eau intérieur
- Control digital électronique.
- "Trop plein", securitee diamètre 3/4".

Modelo	Largo	Alto	Fondo	Potencia Frig.	Capacidad	Peso Neto	Consumo nominal	Caudal grifo abierto (l/h) ΔT=10°C	Refrig.	Rango
Model	Length	Height	Depth	Frig Power	Capacity	Net Weight	Power consumption	Open flow faucet (l/h) ΔT=10°C	Coolant	Range
Modèle	Longueur	Hauteur	Profondeur	Puissance Frig.	Exposition	Poid Net	Consommation électrique	Robinet debit ouvert (l/h) ΔT=10°C	Frigorigène	Gamme
	mm.	mm.	mm.	W	l.	Kg	W			
EAP-175V	880	1140	560	1012	175	103	594	110	R-290	+1°C+3°C
EAP-100H	1405	580	565	583	100	100	346	79	R-290	+1°C+3°C

PVP de opcionales incluidos en equipo, no como repuesto / PVP of options included in the equipment, not as a spare part / PVP d'options incluses dans l'équipement, pas en tant que pièce de rechange

OPCIONES · OPTIONS · OPTIONS

Otros Refrigerantes	Other refrigerants	Autres réfrigérants	consultar - consult - consulter
---------------------	--------------------	---------------------	---------------------------------



SOPORTE PARED **130 €**

OPCIONAL · OPTIONAL · OPTIONEL

Características técnicas y constructivas sujetas a variación sin previo aviso. / We reserve the right to change specifications without prior notice. / Sujet technique et la conception de modifications sans préavis.

	EAP-175V	2.136 €		EAP-100H	1.954 €
	EAPI-175V	2.275 €		EAPI-100H	2.293 €

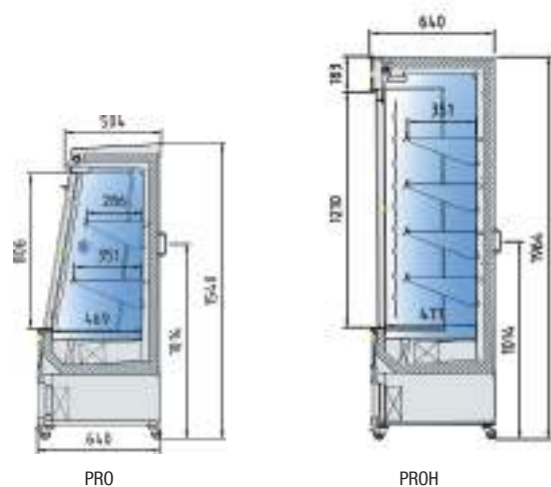

Ejemplo PRO-60 personalizada
 Example PRO-60 custom
 Exemple PRO-60 personnalisé



Ejemplo PRO-60 personalizada
 Example PRO-60 custom
 Exemple PRO-60 personnalisé



PRO-60



PROH-60



PRO-90



PROH-90



Detalle iluminación interior
 Interior lighting detail
 Détail de l'éclairage intérieur

CARACTERÍSTICAS TÉCNICAS

- Exterior en acero plastificado blanco
- Interior en acero acabado epoxy blanco
- Diseñados para bebidas y productos envasados
- Estantes de acero acabado epoxy regulables en altura con portaprecios
- De serie: Luz LED horizontal, vertical y cortina nocturna
- Control digital de temperatura y descarches
- Evaporación y condensación ventilada
- Aislamiento de poliuretano inyectado, libre CFCs, densidad 40 Kg/m³
- Evaporación automática del agua de descarche
- Clase climática 3 (25°C 60%HR) régimen M1, temperatura producto -1/5°C UNE EN ISO 23953-2
- Tensión monofásica 230V 50 Hz
- Refrigerante ecológico R-290

TECHNICAL DATA

- Exterior in plasticised steel white
- Epoxy finished steel interior white
- Designed for beverages and packaged
- Epoxy coated steel shelves adjustable in height with price holders
- Standard: horizontal LED, vertical and night light curtain
- Digital temperature control and defrost
- Ventilated evaporation and condensation
- Insulation: Polyurethane, CFC, density 40 Kg / m³
- Automatic evaporation of defrost water
- Climatic class 3 (25°C 60%HR) regime M1, product temperature -1/5°C UNE EN ISO 23953-2
- Voltage 230V 50 Hz
- Refrigerant ecologic R-290

CARACTÉRISTIQUES TECHNIQUES

- Extérieur acier plastifié blanc
- Finition intérieur en acier époxy blanc
- Design conçu et réalisé pour boissons et produits emballés.
- Étagères epoxy en acier réglables en hauteur avec porte-prix
- Standard: horizontale LED, rideau de lumière verticale et la nuit
- Contrôle digital de température et du dégivrage.
- L'évaporation et la condensation ventilée
- Isolation en polyuréthane injecté, densité de 40 Kg/m³, faible GWP et aucun effet ODP.
- Evaporation automatique de l'eau de dégivrage
- Classe climatique 3 (25°C 60%HR) régime M1, température produit -1/5°C UNE EN ISO 23953-2
- Tension monophasique 230V 50 Hz
- Gaz réfrigérant écologique R-290.

Modelo Model Modèle	Largo Length Longueur (mm)	Alto Height Hauteur (mm)	Fondo Depth Profondeur (mm)	Área de estantes refrigerados Refrigerated shelf area Surface des plans de chargement refroidis (m ²)	Superficie total de exposición Total display area Surface totale de l'exposition (TDA)	Volumen Neto Net Volume Volume Net (L)	Potencia frig. Frig. Power Puissance frig. (W)	Consumo Nominal Nominal Consumption Consommation Nominale (W)	Estantes Shelves Étagères (Uds)
PRO-60	640	1540	640	0,55	0,44	200	967	1435	2
PROH-60	640	1965	640	0,93	0,69	332	967	1487	4
PRO-90	640	1550	915	0,72	0,59	288	1263	1911	2
PROH-90	640	1970	915	1,5	0,91	523	1263	1961	4

230v 60Hz / 115v 60Hz. consultar - consult - consulter

Características técnicas y constructivas sujetas a variación sin previo aviso. / We reserve the right to change specifications without prior notice. / Sujet technique et la conception de modifications sans préavis.

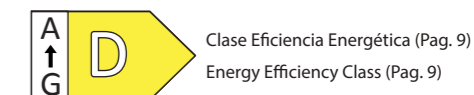

Clase Eficiencia Energética (Pag. 9)
 Energy Efficiency Class (Pag. 9)

PRO-60 2.388 €	PROH-60 2.509 €	PRO-90 2.589 €	PROH-90 2.708 €

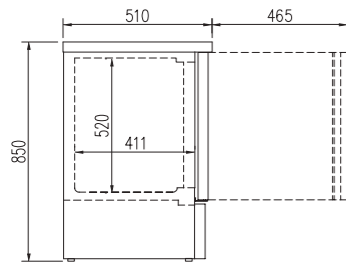

DEC/ DEE - 85

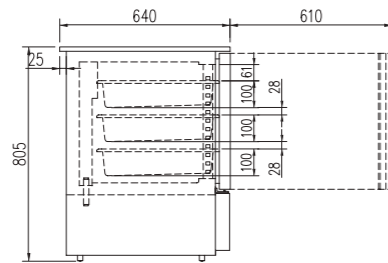

DDP - 140

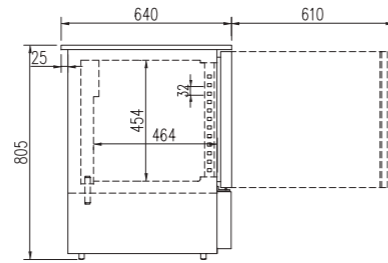

DEC/ DECE / DNR - 140

DEC/ DEE - 85

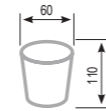

Capacidad: 185 vasos
Capacity: 185 glasses
Capacité: 185 verres

DEC/ DEE - 140

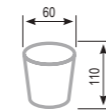

Capacidad: 120 vasos
Capacity: 120 glasses
Capacité: 120 verres

CARACTERÍSTICAS TÉCNICAS

- Exterior en acero inox AISI-304 18/10, excepto el respaldo
- Interior en acero inox AISI-304 18/10, con aristas curvas y fondo embutido
- Puertas de apertura reversible, con sistema de cierre automático y burlete magnético (permanece abierta al superar los 90° de apertura)
- Encimera de acero inox AISI-304 18/10
- Estantes interiores de alambre en acero plastificado, regulables en altura
- Apoyos regulables en altura
- Unidad condensadora ventilada
- Evaporador placa fría (modelos DEC-85)
- Evaporador sistema tiro forzado, con recubrimiento anticorrosión (modelos DEC-140)
- Aislamiento de poliuretano inyectado, densidad 40 Kg/m³, bajo GWP y cero efecto ODP
- Control digital de temperatura, eficiente en la gestión del consumo de energía
- Temperatura de trabajo a 32°C ambiente
- DEE-85 puerta cristal
- DEC-85 puerta ciega
- DEC: puerta ciega -20°C-15°C
- DNR: puerta ciega -2°C+8°C
- DDP: pescado puerta ciega -4°C+4°C
- Gas refrigerante R-290

TECHNICAL DATA

- AISI-304 18/10 stainless steel exterior, except the rear side
- AISI-304 18/10 stainless steel interior, stamped bottom and rounded corners
- Doors with self closing system, blocked opening, magnetic gasket and possibility of changing the opening sense
- AISI-30418/10 stainless steel worktop
- Shelves made of plasticized steel wire, height adjustable
- Adjustable supports
- Fan assisted condenser unit
- Cold plate evaporator (DEC-85 models)
- Fan assisted evaporator, with anticorrosion coating. (DEC-140 models)
- 40 Kg/m³ density polyurethane insulation, low GWP and zero ODP effect
- Energy efficient digital controller of temperature
- Operating temperature 32°C ambient
- DEE-85 glass door
- DEC-85 solid door
- DEC: blind door -20°C-15 °C
- DNR: blind door -2°C to +8°C
- DDP: fish blind door -4°C +4°C
- Refrigerant gas R-290

CARACTÉRISTIQUES TECHNIQUES

- Extérieur en acier inox AISI 304 18/10, à l'exception de la partie arrière
- Intérieur en acier inox AISI 304 18/10, avec bords incurvés et bac encastré
- Ouverture des portes réversibles avec système de fermeture automatique avec joint magnétique (la porte se maintient ouverte lorsque l'angle dépasse les 90 ° à l'ouverture)
- Plan de travail en acier inoxydable AISI 304 18/10
- Étagères intérieures avec Fils d'acier plastifiés, réglables en hauteur.
- Supports réglables en hauteur
- Condensateur ventilé
- Évaporateur avec système de plaque froide. (modèles DEC-85)
- Évaporateur à tirage forcé, avec revêtement anti-corrosion (modèles DEC-140)
- Isolation à base de polyuréthane injecté, densité 40 kg/m³, faible GWP et aucun effet ODP.
- Le Contrôle digital de température ainsi que le dégivrage automatique œuvre à une meilleure gestion de la consommation énergétique.
- Température ambiante de travail à 32°C
- DEE-85 porte en verre
- DEC-85 porte solide
- DEC, porte aveugle -20°C-15°C
- DNR: porte aveugle -2°C et +8°C
- DDP: porte aveugle poissons -4°C +4°C
- Gaz réfrigérant R-290



DEC-85



DEE-85



DDP-140



DEC-140



Modelo Model Modèle	Largo Length Longueur mm.	Alto Height Hauteur mm.	Fondo Depth Profondeur mm.	Rango Range Gamme	Capacidad Capacity Exposition L	Estantes Shelves Étagères	Cajas Container Conteneur	Juego de guías Sets of slides Kit de guides	Consumo Nominal Nominal Consumption Consommation Nominale W	Potencia Frig. Frig Power Puissance Frig. W
DEE-85	510	850	505	-5°C -10°C	85	1	-	-	160	158
DEC-85	510	850	505	-5°C -10°C	85	1	-	-	160	158
DEC-140	645	805	640	-5°C-15°C	125	2	0	2	285	361
DDP-140	645	805	640	-5°C -1°C	125	0	3	3	185	225
DNR-140	645	805	640	-2°C+8°C	125	2	0	2	164	190

PVP de opcionales incluidos en equipo, no como repuesto / PVP of options included in the equipment, not as a spare part / PVP d'options incluses dans l'équipement, pas en tant que pièce de rechange

OPCIONES · OPTIONS · OPTIONS

Set 4 ruedas	4 castors set	Jeu 4 roulettes	93 € x set
Cambio R-134a por R-290	R-134a to R-290	Changement R-134a par R-290	23 €
Cerradura puerta cristal	Glass door lock	Serrure à porte en verre	58 €
Cerradura puerta inox	Inox door lock	Serrure à porte inox	0 €
230v 60Hz / 115v 60Hz	230v 60Hz / 115v 60Hz	230v 60Hz / 115v 60Hz	consultar - consult - consulter

Características técnicas y constructivas sujetas a variación sin previo aviso. / We reserve the right to change specifications without prior notice. / Sujet technique et la conception de modifications sans préavis.

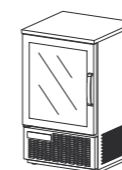

DEE-85 1.528 €

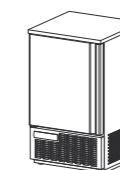

DEC-85 1.373 €

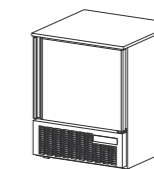

DEC-140 1.756 €
DNR-140 1.435 €
DDP-140 1.554 €

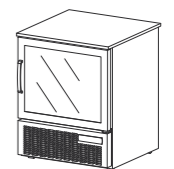

DECE-140 1.990 €
DNRE-140 1.535 €
DDPE-140 1.670 €

6 MESAS REFRIGERADAS

REFRIGERATED COUNTER

MEUBLE RÉFRIGÉRÉE



CARACTERÍSTICAS TÉCNICAS

- Exterior en acero inox AISI-304 18/10, excepto el respaldo
- Interior en acero inox AISI-304 18/10, con aristas curvas y fondo embutido
- Puertas de vidrio con serigrafía mínima gris oscuro con apertura reversible, con sistema de cierre automático y burlete magnético (permanece abierta al superar los 90° de apertura)
- Contrapuerta inox embutida
- Luz interior en modelos puerta de cristal
- Encimera de acero inox AISI-304 18/10 con frente recto y peto trasero sanitario de 100 mm (opcional sin peto según modelo)
- Estantes interiores de varilla en acero plastificado, regulables en altura, sobre apoyos inox
- Pies en tubo de acero inox ajustables en altura 125 200 mm
- Unidad condensadora ventilada y extraíble
- Evaporador sistema tiro forzado, con recubrimiento anticorrosión
- Evaporación automática del agua de descarche de serie, excepto modelos pre-instalación
- Aislamiento de poliuretano inyectado, densidad 40 Kg/m³, bajo GWP y cero efecto ODP
- Control digital de temperatura y descarches, eficiente en la gestión del consumo de energía
- Temperatura de trabajo a 32°C ambiente
- Cajoneras inox refrigeradas desmontables sobre guías telescópicas con sistema autocierre

TECHNICAL DATA

- AISI-304 18/10 stainless steel exterior, except the rear side
- AISI-304 18/10 stainless steel interior, stamped bottom and rounded corners
- Glass doors with minimal dark gray serigraphy with reversible opening, with automatic closing system and magnetic weather stripping (remains open when opening more than 90°)
- Rear-door by stamped steel
- Interior light in glass door models
- AISI-304 18/10 stainless steel worktop, with straight front and 100 mm sanitary up stand (optional without up stand depending on model)
- Shelves made of plasticized steel wire, height adjustable by stainless steel supports
- AISI -304 18/10 adjustable legs, 125 to 200 mm
- Removable and fan assisted condenser unit
- Fan assisted evaporator, with anticorrosion coating.
- Automatic evaporation of defrost water ass standard, except models preinstalation
- 40 Kg/m³ density polyurethane insulation, low GWP and zero ODP effect
- Energy efficient digital controller of temperature and defrosts
- Operating temperature 32°C ambient
- Removable stainless refrigerated drawers on telescopic guides with self-closing system

CARACTÉRISTIQUES TECHNIQUES

- Extérieur en acier inox AISI 304 18/10, à l'exception de la partie arrière
- Intérieur en acier inox AISI 304 18/10, avec bords incurvés et bac encastré.
- Portes en verre avec sérigraphie minimale gris foncé à ouverture réversible, avec système de fermeture automatique et coupe-froid magnétique (reste ouvert lors d'une ouverture à plus de 90°)
- Contreporte en Inox encastrée
- Lumière intérieure dans les modèles de portes en verre
- Plan de travail en acier inoxydable AISI 304 18/10 avec avant droit et arrière avec bavette de 100mm et évacuation sanitaire (sur option : sans bavette en fonction du modèle)
- Étagères intérieures avec Fils d'acier plastifiés, réglables en hauteur, posées sur soutien en inox.
- Pies en tube d'acier inoxydable réglables en hauteur 125 - 200 mm
- Unité de condensation ventilée extractible
- Evaporateurs avec système de marche forcée et recouvrement anticorrosion.
- Evaporation automatique des eaux de dégivrage en série, sauf les modèles préinstallation.
- Isolation à base de polyuréthane injecté, densité 40 kg/m³, faible GWP et aucun effet ODP.
- Le Contrôle digital de température ainsi que le dégivrage automatique œuvre à une meilleure gestion de la consommation énergétique.
- Température ambiante de travail à 32°C
- Amovibles tiroirs réfrigérés inoxydable sur glissières télescopiques avec système de fermeture automatique



BMR Página 261
Mesas frías SNACK
Counter SNACK
Meuble SNACK



MP / MS Página 285
Mesa fría saladette GN 1/1
GN 1/1 Saladette counter
Meuble saladette GN 1/1



CMR Página 265
Frente mostrador SNACK
SNACK front desk
Réception SNACK



DMFE Página 287
Mesa fría salad-cheff GN 1/1
GN 1/1 salad-cheff counter
Meuble salad-cheff GN 1/1



CMC Página 267
Frente mostrador cafetero compacto
Front desk compact coffee
Bureau café compact avant



DMFK Página 289
Mesa fría GN 1/1 fast food
GN 1/1 fast food counter
Meuble fast food GN 1/1



ECM Página 269
Estantería frente mostrador
Shelf front desk
Avant de conservation bureau



MEI Página 291
Mesa fría sushi-cheff
Sushi-cheff counter
Meuble sushi-cheff



DHMRG Página 271
Mesa fría GN 1/1 alta eficiencia
GN 1/1 counter high efficiency
Meuble GN 1/1 haute efficacité



DMFPP Página 293
Mesa fría pizza compacta
Compact pizza counter
Meuble compacte



BRG Página 273
Mesa fría GN 1/1
GN 1/1 counter
Meuble GN 1/1



MPC Página 295
Mesa fría pizza
Pizza counter
Meuble pizza



BCR Página 277
Mesa fría GN 1/1 bajo cocina
GN 1/1 under kitchen counter
Sous cuisine meuble GN 1/1



IE Página 301
Expositor de ingredientes
Exhibitor ingredients
Ingrédients d'exposants



BPR Página 281
Mesa pastelera
Cake counter
Meuble pâtisserie

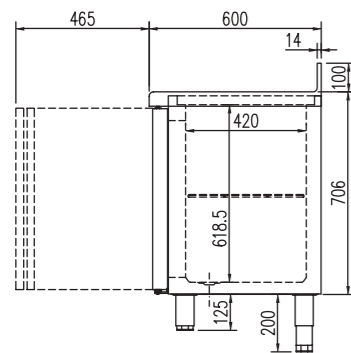

TOMA DE DESAGÜE · DRAIN OUTLET · DRAIN FAIRE



DETALLE FREGADERO · DETAIL SINK · DETAIL ÉVIER



BMR-200-2/3

Cajonera triple lado motor, es necesario instalar evaporadores centrales
Triple sided motor chest, it is necessary to install central evaporators
Coffre moteur à trois côtés, il est nécessaire d'installer des évaporateurs centraux

Ver características técnicas en página 250 / See technical data in page 250 / Voir caractéristiques techniques page 250

Modelo Modèle	Largo Longueur mm	Alto Hauteur mm	Fondo Profondeur mm	Rango Range Gamme	Estantes Shelves Étagères	Capacidad Capacity Exposition L	Voltaje Voltage Tension	Refrig. Coolant Frigorigène	Potencia Frig. Frig Power Puissance Frig. W	Consumo Nominal Nominal Consumption Consommation Nominale W	Rango Range Gamme	clase climate 2015/1094 EN16825 Rango Range Gamme
BMR-150	1495	850	600	-2°C +8°C	2	245	230 V - 50 Hz	R-290	502	235	B	5 (40°C 40%)
BMRV-150	1495	850	600	-2°C +8°C	2	245	230 V - 50 Hz	R-290	502	243	-	5 (40°C 40%)
BMR-200	2020	850	600	-2°C +8°C	3	380	230 V - 50 Hz	R-290	502	238	B	5 (40°C 40%)
BMRV-200	2020	850	600	-2°C +8°C	3	380	230 V - 50 Hz	R-290	502	251	-	5 (40°C 40%)
BMR-250	2545	850	600	-2°C +8°C	4	516	230 V - 50 Hz	R-290	845	355	C	5 (40°C 40%)
BMRV-250	2545	850	600	-2°C +8°C	4	516	230 V - 50 Hz	R-290	845	357	-	5 (40°C 40%)
BMR-300	3070	850	600	-2°C +8°C	5	651	230 V - 50 Hz	R-290	845	355	C	5 (40°C 40%)
BMRV-300	3070	850	600	-2°C +8°C	5	651	230 V - 50 Hz	R-290	845	380	-	5 (40°C 40%)
BMC-150	1495	850	600	-20°C -15°C	2	245	230 V - 50 Hz	R-290	606	535	D	5 (40°C 40%)
BMCV-150	1495	850	600	-20°C -15°C	2	245	230 V - 50 Hz	R-290	606	544	-	4 (30°C 55%)
BMC-200	2020	850	600	-20°C -15°C	3	380	230 V - 50 Hz	R-290	606	556	E	4 (30°C 55%)
BMCV-200	2020	850	600	-20°C -15°C	3	380	230 V - 50 Hz	R-290	606	548	-	4 (30°C 55%)

OPCIONES · OPTIONS · OPTIONS

Parrilla adicional 405x525 central	405x525 central extra shelf central	Grille additionnelle 405x525 central	25 €
Parrilla adicional 405x460 lateral	405x460 side extra shelf	Grille additionnelle 405x460 latéral	25 €
Cajonera doble inox, auto-cierre	Double drawers set, self-closing	Tiroirs doubles inox, fermeture automatique	476€ x set
Cajonera triple inox, auto-cierre	Triple drawers set, self-closing	Tiroirs triple inox, fermeture automatique	710 € x set
Cerradura puerta inox	Solid door lock	Serrure à porte inox	25 € x ud
Cerradura puerta cristal	Glass door lock	Serrure à porte en verre	61 € x ud
Motor lado izquierdo	Left side engine	Moteur côté gauche	73 €
Encimera sin peto	No upstand worktop	Plan de travail sans panneau de protection	0 €
Set 4 ruedas	4 Castors set	Jeu 4 roulettes	98 € x set
Set 6 ruedas	6 Castors set	Jeu 6 roulettes	146 € x set
Evaporación automática	Automatic evaporation	Évaporation automatique	116 €
Registrador de alarmas HACCP	HACCP alarm recorder	Enregistreur d'alarme HACCP	consultar - consult - consulter
Tropicalizado 43°C	Tropicalized to 43°C	Tropicalisé 43°C	consultar - consult - consulter
Respaldo inox	Stainless steel rear side	Soutien en inox	consultar - consult - consulter
230V 60hz / 115v 60hz	230V 60hz / 115v 60hz	230V 60hz / 115v 60hz	consultar - consult - consulter

Características técnicas y constructivas sujetas a variación sin previo aviso. / We reserve the right to change specifications without prior notice. / Sujet technique et la conception de modifications sans préavis.



BMR-200



DETALLE TIRADOR
DETAIL HANDLE
DETAIL TIREUR



BMR-200-V

BMR-150 2.283 €	BMR-200 2.708 €	BMR-250 3.204 €	BMR-300 3.835 €
BMC-150 2.896 €	BMC-200 3.345 €		
BMR-150-V 2.678 €	BMR-200-V 3.237 €	BMR-250-V 3.886 €	BMR-300-V 4.632 €
BMC-150-V 3.272 €	BMC-200-V 3.920 €		
BMR-150-F 2.581 €	BMR-200-F 2.989 €	BMR-250-F 3.512 €	BMR-300-F 4.236 €

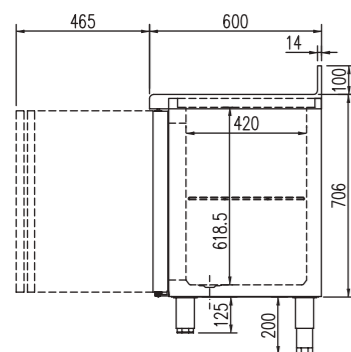

BMRP-220-2/3



DETALLE PREINSTALACION
detailed pre-installation
détailée de pré-installation

Los modelos preinstalación NO incluyen valvulería, capilar y bandeja de evaporación automática
The preinstallation models do not include valves, capillary and automatic evaporation tray
Les modèles de préinstallation ne comprennent pas les vannes, capillaire et le plateau d'évaporation automatique

MESA FRÍA SNACK REFRIGERACIÓN Y CONGELADOS PRE-INSTALACIÓN

SNACK COUNTER, CHILLER AND FREEZER FOR REMOTE CONDENSER UNIT

TABLE RÉFRIGÉRÉE SNACKS: RÉFRIGÉRATION ET CONGÉLATION: PRÉ-INSTALLATION



BMRP-220

Ver características técnicas en página 250 / See technical data in page 250 / Voir caractéristiques techniques page 250

Modelo Model Modèle	Largo Length Longueur mm	Alto Height Hauteur mm	Fondo Depth Profondeur mm	Potencia Frig. Frig Power Puissance Frig. W	Capacidad Capacity Exposition L	Peso Neto Net Weight Poid Net Kg	Estantes x set Shelves x set Étagères x set	Voltaje Voltage Tension	Refrig. Coolant Frigorigène	Rango Range Gamme
BMRP/BMRPV-120	1195	850	600	300	246	68	2	230 V - 50 Hz	R-134a	-2°C+8°C
BMRP/BMRPV-170	1720	850	600	356	380	89	3	230 V - 50 Hz	R-134a	-2°C+8°C
BMRP/BMRPV-220	2245	850	600	485	516	110	4	230 V - 50 Hz	R-134a	-2°C+8°C
BMRP/BMRPV-270	2770	850	600	485	651	135	5	230 V - 50 Hz	R-134a	-2°C+8°C
BMCP/BMCPV-120	1195	850	600	353	245	68	2	230 V - 50 Hz	R-449A	-20°C-15°C
BMCP/BMCPV-170	1720	850	600	452	380	89	3	230 V - 50 Hz	R-449A	-20°C-15°C
BMCP/BMCPV-220	2245	850	600	610	516	110	4	230 V - 50 Hz	R-449A	-20°C-15°C



BMRP-170-V

OPCIONES - OPTIONS - OPTIONS

Parrilla adicional 405x525 central	405x525 central extra shelf	Grille additionnelle 405x525 central	25 €
Parrilla adicional 405x460 lateral	405x460 side extra shelf	Grille additionnelle 405x460 latéral	25 €
Cajonera doble inox, auto-cierre	Double drawers set, self-closing	Tiroirs doubles inox, fermeture automatique	476€ x set
Cajonera triple inox, auto-cierre	Triple drawers set, self-closing	Tiroirs triple inox, fermeture automatique	710 € x set
Cerradura puerta inox	Solid door lock	Serrure à porte inox	25 € x ud
Cerradura puerta cristal	Glass door lock	Serrure à porte en verre	61 € x ud
Motor lado izquierdo	Left side engine	Moteur côté gauche	73 €
Encimera sin peto	No upstand worktop	Plan de travail sans panneau de protection	0 €
Set 4 ruedas	4 Castors set	Jeu 4 roulettes	98 € x set
Set 6 ruedas	6 Castors set	Jeu 6 roulettes	146 € x set
Evaporación automática	Automatic evaporation	Évaporation automatique	116 €
Registrador de alarmas HACCP	HACCP alarm recorder	Enregistreur d'alarme HACCP	consultar - consult - consulter
Tropicalizado 43°C	Tropicalized to 43°C	Tropicalisé 43°C	consultar - consult - consulter
Respaldo inox	Stainless steel rear side	Soutien en inox	consultar - consult - consulter
230V 60hz / 115v 60hz	230V 60hz / 115v 60hz	230V 60hz / 115v 60hz	consultar - consult - consulter

BMRP-120 1.849 €	BMRP-170 2.302 €	BMRP-220 2.666 €	BMRP-270 3.163 €
BMCP-120 2.037 €	BMCP-170 2.533 €	BMCP-220 2.916 €	
BMRP-120-V 2.160 €	BMRP-170-V 2.754 €	BMRP-220-V 3.250 €	BMRP-270-V 3.892 €
BMCP-120-V 2.479 €	BMCP-170-V 3.180 €	BMCP-220-V 3.761 €	

Características técnicas y constructivas sujetas a variación sin previo aviso. / We reserve the right to change specifications without prior notice. / Sujet technique et la conception de modifications sans préavis.

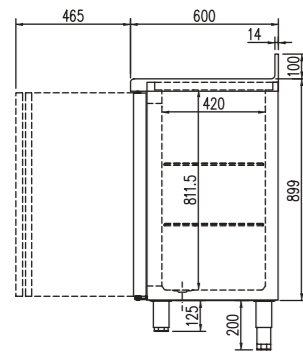

CMRP-220



DETALLE CAJON TOLVA
HOPPER DRAWER DETAIL
DÉTAIL DU TIROIR DE TRÉMIE



DETALLE TIRADOR
DETAIL HANDLE
DÉTAIL TIREUR

Los modelos preinstalación NO incluyen valvulería, capilar y bandeja de evaporación automática
The preinstallation models do not include valves, capillary and automatic evaporation tray
Les modèles de préinstallation ne comprennent pas les vannes, capillaire et le plateau d'évaporation automatique
Ver características técnicas en página 250 / See technical data in page 250 / Voir caractéristiques techniques page 250

Modelo Model Modèle	Largo Length Longueur mm	Alto Height Hauteur mm	Fondo Depth Profondeur mm	Rango Range Gamme	Estantes Shelves Étagères	Capacidad Capacity Exposition L	Voltaje Voltage Tension	Refrig. Coolant Frigorigène	Potencia Frig. Frig Power Puissance Frig. W	Consumo Nominal Nominal Consumption Consommation Nominale W	Rango Range Gamme	clase climate 2015/1094 EN16825
CMR-150	1495	1040	600	-2°C +8°C	4	325	230 V - 50 Hz	R-290	502	235	A	5 (40°C 40%)
CMRV-150	1495	1040	600	-2°C +8°C	4	325	230 V - 50 Hz	R-290	502	247	-	5 (40°C 40%)
CMR-200	2020	1040	600	-2°C +8°C	6	504	230 V - 50 Hz	R-290	502	238	B	5 (40°C 40%)
CMRV-200	2020	1040	600	-2°C +8°C	6	504	230 V - 50 Hz	R-290	502	255	-	5 (40°C 40%)
CMR-250	2545	1040	600	-2°C +8°C	8	684	230 V - 50 Hz	R-290	845	340	B	5 (40°C 40%)
CMRV-250	2545	1040	600	-2°C +8°C	8	684	230 V - 50 Hz	R-290	845	363	-	5 (40°C 40%)
CMR-300	3070	1040	600	-2°C +8°C	10	863	230 V - 50 Hz	R-290	845	355	B	5 (40°C 40%)
CMRV-300	3070	1040	600	-2°C +8°C	10	863	230 V - 50 Hz	R-290	845	384	-	5 (40°C 40%)
CMRP / CMRPV-120	1195	1040	600	-2°C +8°C	4	325	230 V - 50 Hz	R-134a	300	-	-	
CMRP / CMRPV-170	1720	1040	600	-2°C +8°C	6	504	230 V - 50 Hz	R-134a	356	-	-	
CMRP / CMRPV-220	2245	1040	600	-2°C +8°C	8	684	230 V - 50 Hz	R-134a	485	-	-	
CMRP / CMRPV-270	2770	1040	600	-2°C +8°C	10	863	230 V - 50 Hz	R-134a	485	-	-	

Posibilidad de fabricación en rango de temperatura -20 -15°C / Possibility of manufacturing in temperature range -20 -15°C / Possibilité de fabrication dans une plage de température -20 -15°C

OPCIONES - OPTIONS - OPTIONS

Parrilla adicional 405x525 central	405x525 central extra shelf	Grille additionnelle 405x525 central	25 €
Parrilla adicional 405x460 lateral	405x460 side extra shelf	Grille additionnelle 405x460 latéral	25 €
Cajonera doble inox, auto-cierre	Double drawers set, self-closing	Tiroirs doubles inox, fermeture automatique	742 € x set
Cajonera doble cristal, auto-cierre	Double glass drawers set, self-closing	Tiroirs doubles en verre, fermeture automatique	871 € x set
Cajonera triple inox, auto-cierre	Triple drawers set, self-closing	Tiroirs triple inox, fermeture automatique	933 € x set
Cerradura puerta inox	Solid door lock	Serrure à porte inox	25 € x ud
Motor lado izquierdo	Left side engine	Moteur côté gauche	73 €
Encimera sin peto	No upstand worktop	Plan de travail sans panneau de protection	0 €
Set 4 ruedas	4 Castors set	Jeu 4 roulettes	98€ x set
Set 6 ruedas	6 Castors set	Jeu 6 roulettes	146 € x set
Evaporación automática	Automatic evaporation	Évaporation automatique	116 €
Registrador de alarmas HACCP	HACCP alarm recorder	Enregistreur d'alarme HACCP	consultar - consult - consulter
Respaldo inox	Stainless steel rear side	Soutien en inox	consultar - consult - consulter
Tropicalizado 43°C	Tropicalized to 43°C	Tropicalisé 43°C	consultar - consult - consulter
Exterior blanco o negro	Black or white exterior	Extérieur noir ou blanc	consultar - consult - consulter
230V 60hz / 115v 60hz	230V 60hz / 115v 60hz	230V 60hz / 115v 60hz	consultar - consult - consulter

Características técnicas y constructivas sujetas a variación sin previo aviso. / We reserve the right to change specifications without prior notice. / Sujet technique et la conception de modifications sans préavis.

FRENTE MOSTRADOR SNACK, REFRIGERACIÓN Y PREINSTALACIÓN
SNACK BACK BAR COUNTER, CHILLER AND PREINSTALLATION
COMPTOIR AVANT SNACK, RÉFRIGÉRATION ET LA PRÉINSTALLATION



CMR-250

SERIGRAFÍA PERIMETRAL
PERIMETRAL SERIGRAPHY
SÉRIGRAPHIE PÉRIMÉTRIQUE



LED

CMR-250-V

CMR-150 2.567 €	CMR-200 3.089 €	CMR-250 3.598 €	CMR-300 4.156 €
CMR-150-V 3.008 €	CMR-200-V 3.686 €	CMR-250-V 4.391 €	CMR-300-V 5.082 €
CMRP-120 1.965 €	CMRP-170 2.433 €	CMRP-220 2.857 €	CMRP-270 3.398 €
CMRP-120-V 2.360 €	CMRP-170-V 3.008 €	CMRP-220-V 3.589 €	CMRP-270-V 4.308 €

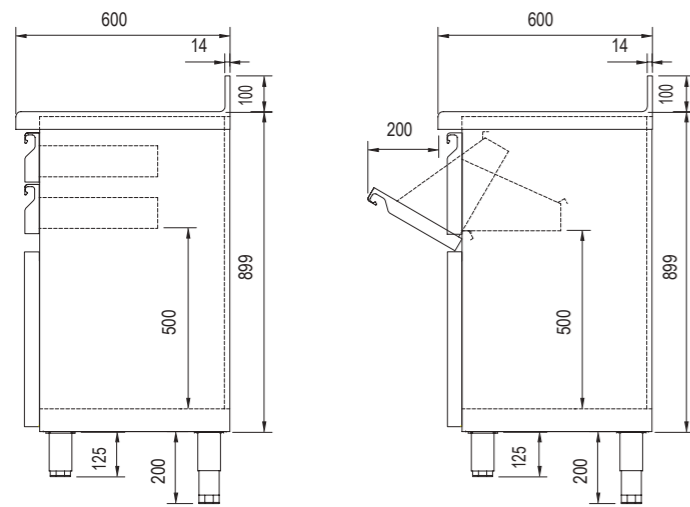

CARACTERÍSTICAS TÉCNICAS	TECHNICAL DATA	CARACTÉRISTIQUES TECHNIQUES
<ul style="list-style-type: none"> Módulos de diseño compacto Exterior y estantes en acero inox AISI-304 18/10, excepto el respaldo Respaldo en acero plastificado Encimera de acero inox AISI-304 18/10 con frente curvo y peto trasero sanitario de 100 mm (Opcional sin peto) Cajones con guías de rodamientos Cajón tolva para café, desmontable Cajones y tolva, son intercambiables Pies en tubo de acero inox ajustables en altura 125-200 mm Pueden fabricarse, bajo pedido, en diferentes medidas 	<ul style="list-style-type: none"> Compact designed modules AISI-304 18/10 stainless steel exterior and shelf, except the rear side AISI-304 18/10 stainless steel exterior and shelves, except the rear side Rear panel in plasticized steel AISI-30418/10 stainless steel worktop, with rounded front and 100 mm sanitary up stand (optional without up stand) Drawers with slides Detachable coffee-grounds hopper Interchangeable drawers (auxiliary and coffee) AISI -304 18/10 adjustable legs, 125 to 200 mm Can be produced on request, in different measures 	<ul style="list-style-type: none"> Modules de design compact Extérieur et étagères en acier inoxydable AISI 304 18/10, sauf la partie arrière Dossier en acier plastifié Plan de travail en acier inoxydable AISI 304 18/10, avec partie avant inclinée et panneau de protection arrière de 100mm (possible sans panneau de protection sur option) Tiroirs avec rails à roulement Tiroir-trémie de café amovible. Tiroir et trémie de café sont interchangeables. Pieds en tube d'acier inoxydable, réglables en hauteur 125-200mm Ce produit peut se fabriquer en différentes dimensions, sur commande.



CMC-50-T



CMC-90

	→	↑	↗	👜	📦	🗑️	🚪
Modelo	Largo	Alto	Fondo	Peso Neto	Cajones	Tolva	Puertas
Model	Length	Height	Depth	Net Weight	Drawers	Hopper	Doors
Modèle	Longueur	Hauteur	Profondeur	Poid Net	Tiroirs	Trémie	Portes
	mm	mm	mm	Kg			
CMC-50-T	475	1040	600	28	0	1	1
CMC-50-C	475	1040	600	28	2	0	1
CMC-90	915	1040	600	55	2	1	2
CMC-140	1375	1040	600	85	4	1	2



CMC-140



CMR-150 + CMC-50-T
 Encimera especial
 Special worktop
 Surface spéciale

CMC-50-T 557 €	CMC-50-C 557 €	CMC-90 930 €	CMC-140 1.332 €

Características técnicas y constructivas sujetas a variación sin previo aviso. / We reserve the right to change specifications without prior notice. / Sujet technique et la conception de modifications sans préavis.

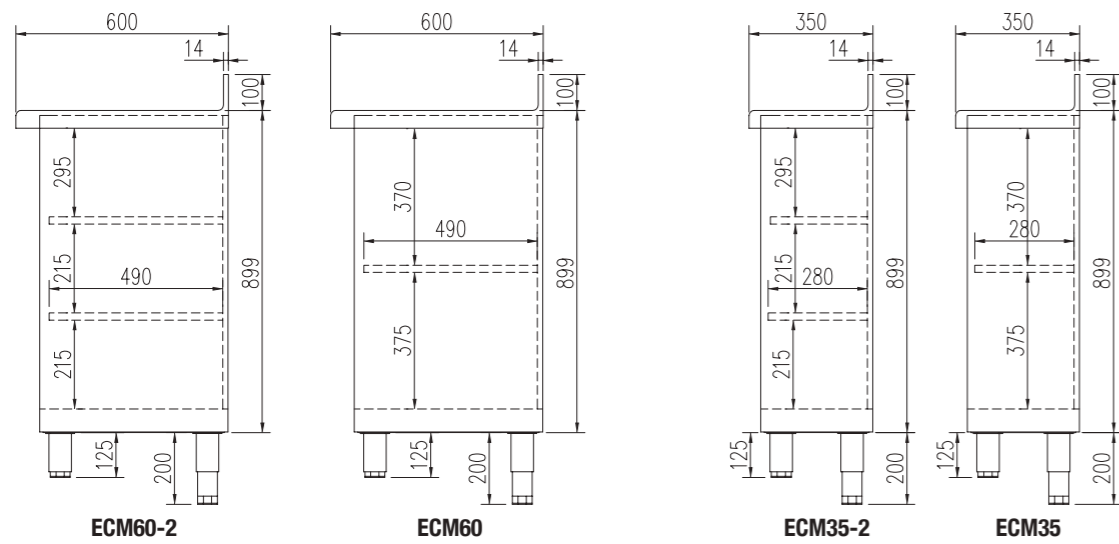

ECM60-200-2

CARACTERÍSTICAS TÉCNICAS	TECHNICAL DATA	CARACTÉRISTIQUES TECHNIQUES
<ul style="list-style-type: none"> Exterior y estantes en acero inox AISI-304 18/10, excepto el respaldo Respaldo en acero plastificado Encimera de acero inox AISI-304 18/10 con frente curvo y peto trasero sanitario de 100 mm (Opcional sin peto) Pies en tubo de acero inox ajustables en altura 125 200 mm ECM-2: de serie dos estantes Pueden fabricarse, bajo pedido, en diferentes medidas 	<ul style="list-style-type: none"> AISI-304 18/10 stainless steel exterior and shelves, except the rear side Rear panel in plasticized steel AISI-30418/10 stainless steel worktop, with rounded front and 100 mm sanitary up stand (optional without up stand) AISI -304 18/10 adjustable legs, 125 to 200mm ECM-2: two shelves as standard Can be produced on request, in different measures 	<ul style="list-style-type: none"> Extérieur et intérieur en acier inoxydable AISI 304 18/10, sauf la partie arrière Dossier en acier plastifié Plan de travail en acier inoxydable AISI-304 18/10 , avec partie avant inclinée et panneau de protection arrière de 100mm (possible sans panneau de protection sur option) Pieds en tube d'acier inoxydable, réglables en hauteur 125-200mm ECM 2 : fournie de série avec deux étagères. Ce produit peut se fabriquer en différentes dimensions, sur commande

Modelo Model Modèle	Largo Length Longueur mm	Alto Height Hauteur mm	Fondo Depth Profondeur mm	Estantes Shelves Étagères
ECM60-100	990	1040	600	1
ECM60-150	1495	1040	600	1
ECM60-200	2020	1040	600	1
ECM35-100	990	1040	350	1
ECM35-150	1495	1040	350	1
ECM35-200	2020	1040	350	1

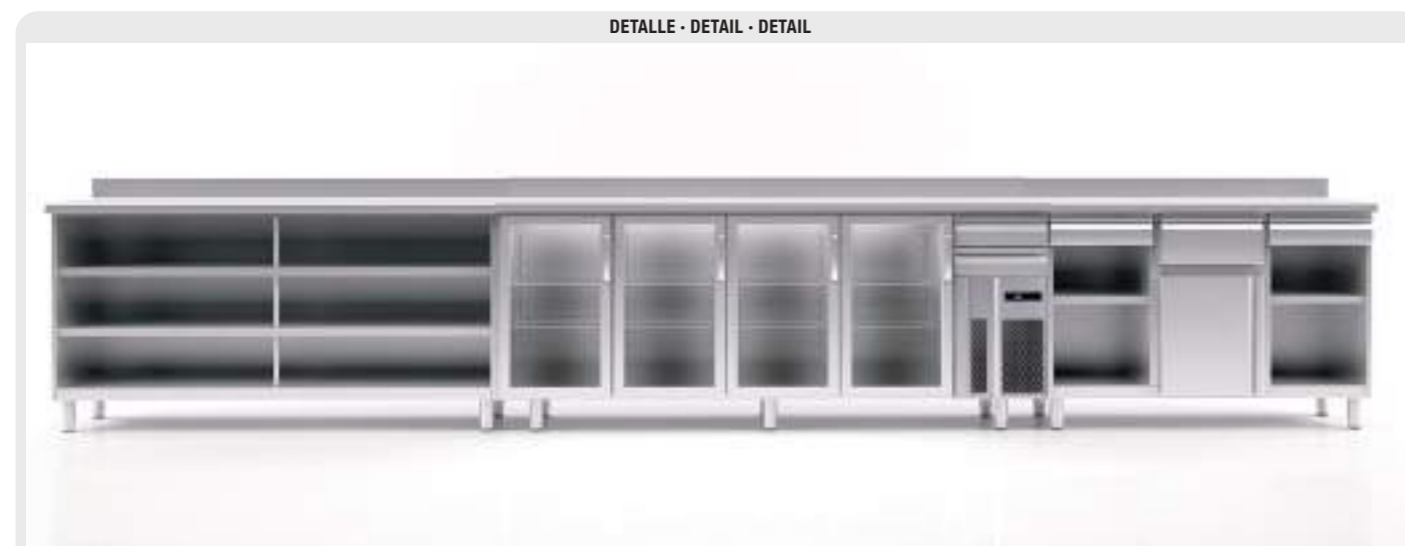

ECMC35-100

	ECM35-100 502 €		ECM35-150 701 €		ECM35-200 899 €		ECM60-100 655 €		ECM60-150 811 €		ECM60-200 1.006 €
	ECM35-100-2 569 €		ECM35-150-2 763 €		ECM35-200-2 943 €		ECM60-100-2 757 €		ECM60-150-2 890 €		ECM60-200-2 1.104 €

Características técnicas y constructivas sujetas a variación sin previo aviso. / We reserve the right to change specifications without prior notice. / Sujet technique et la conception de modifications sans préavis.

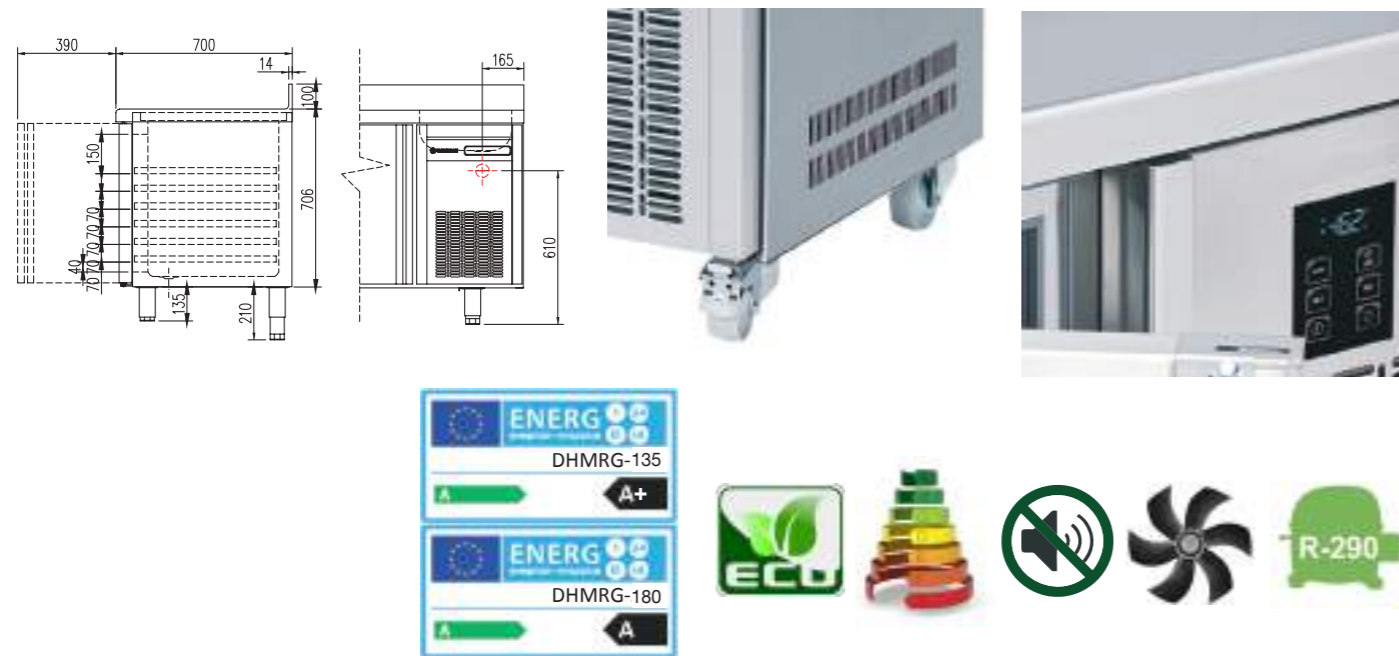

DHMRG-135

A
0,92
 KW/24h



DETALLE TIRADOR
 DETAIL HANDLE
 DETAIL TIREUR

A
1,36
 KW/24h



DHMRG-180

Ver características técnicas en página 250 / See technical data in page 250 / Voir caractéristiques techniques page 250

Modelo Model Modèle	Largo Length Longueur mm	Alto Height Hauteur mm	Fondo Depth Profondeur mm	Rango Range Gamme	Estantes Shelves Étagères	Pares de guías Sets of slides Kit de guides	Capacidad Capacity Exposition L	Voltaje Voltage Tension	Refrig. Coolant Frigorigène	Potencia Frig. Frig Power Puissance Frig. W	Consumo Nominal Nominal Consumption Consommation Nominale W	Rango Range Gamme	Rango Range Gamme
DHMRG-135	1345	850	700	-2°C +8°C	2	2	255	230 V - 50 Hz	R-290	502	187	A+	5 40°C 40%
DHMRG-180	1795	850	700	-2°C +8°C	3	3	399	230 V - 50 Hz	R-290	502	192	A	5 40°C 40%

OPCIONES · OPTIONS · OPTIONS

Parrilla suplemento	Suplement extra shelf	Grille additionnelle Supplement	21 € x ud
Parrilla adicional 530 X 325 GN1/1	530 X 325 GN1/1 extra shelf	Grille additionnelle 530 X 325 GN1/1	28 € x ud
Set adicional guías GN 1/1 340500006	GN 1/1 slides extra set	Kit supplémentaire de guides GN 1/1	30 € x set
Cajonera doble inox, auto-cierre	Double drawers set, self-closing	Tiroirs doubles inox, fermeture automatique	599 € x set
Cajonera triple inox, auto-cierre	Triple drawers set, self-closing	Tiroirs triple inox, fermeture automatique	790 € x set
Cerradura puerta inox	Solid door lock	Serrure à porte inox	25 € x ud
Cerradura puerta cristal	Glass door lock	Serrure à porte en verre	61 € x ud
Motor lado izquierdo	Left side engine	Moteur côté gauche	73 €
Encimera sin peto	No upstand worktop	Plan de travail sans panneau de protection	0 €
Set 4 ruedas	4 Castors set	Jeu 4 roulettes	98 € x set
Set 6 ruedas	6 Castors set	Jeu 6 roulettes	146 € x set
Evaporación automática	Automatic evaporation	Évaporation automatique	116 €
Registrador de alarmas HACCP	HACCP alarm recorder	Enregistreur d'alarme HACCP	consultar - consult - consulter
Tropicalizado 43°C	Tropicalized to 43°C	Tropicalisé 43°C	consultar - consult - consulter
Respaldo inox	Stainless steel rear side	Soutien en inox	consultar - consult - consulter
230V 60hz / 115v 60hz	230V 60hz / 115v 60hz	230V 60hz / 115v 60hz	consultar - consult - consulter

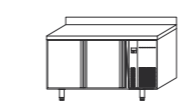

DHMRG-135 **3.169 €**

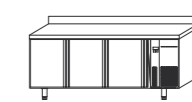

DHMRG-180 **3.638 €**

Características técnicas y constructivas sujetas a variación sin previo aviso. / We reserve the right to change specifications without prior notice. / Sujet technique et la conception de modifications sans préavis.

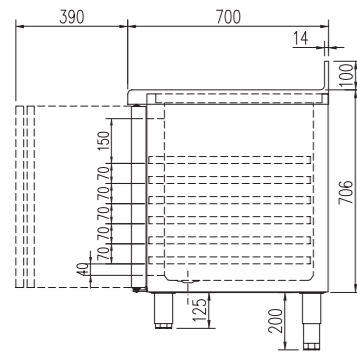

BRG-180-2/3



DETALLE FREGADERO - DETAIL SINK - DETAIL ÉVIER



BRG-180

Ver características técnicas en página 250 / See technical data in page 250 / Voir caractéristiques techniques page 250
* Gas opcional / * Optional gas / * Gaz optionnel

Modelo Model Modèle	Largo Length Longueur mm	Alto Height Hauteur mm	Fondo Depth Profondeur mm	Rango Range Gamme	Estantes Shelves Étagères	Pares de guías Sets of slides Kit de guides	Capacidad Capacity Exposition L	Voltaje Voltage Tension	Refrig. Coolant Frigorigène	Potencia Frig. Frig Power Puissance Frig. W	Consumo Nominal Nominal Consumption Consommation Nominale W	Rango Range Gamme	Rango Range Gamme
BRG-135	1345	850	700	-2°C +8°C	2	2	255	230 V - 50 Hz	R-290	502	235	B	5 (40°C 40%)
BRGV-135	1345	850	700	-2°C +8°C	2	2	255	230 V - 50 Hz	R-290	502	246	-	5 (40°C 40%)
BRG-180	1795	850	700	-2°C +8°C	3	3	399	230 V - 50 Hz	R-290	502	238	B	5 (40°C 40%)
BRGV-180	1795	850	700	-2°C +8°C	3	3	399	230 V - 50 Hz	R-290	502	246	-	5 (40°C 40%)
BRG-225	2245	850	700	-2°C +8°C	4	4	543	230 V - 50 Hz	R-290	845	340	C	5 (40°C 40%)
BRGV-225	2245	850	700	-2°C +8°C	4	4	543	230 V - 50 Hz	R-290	845	352	-	5 (40°C 40%)
BRG-270	2695	850	700	-2°C +8°C	5	5	686	230 V - 50 Hz	R-290	845	355	C	5 (40°C 40%)
BRGV-270	2695	850	700	-2°C +8°C	5	5	686	230 V - 50 Hz	R-290	845	369	-	5 (40°C 40%)
BCG-135	1345	850	700	-20°C -15°C	2	2	255	230 V - 50 Hz	R-290	606	535	D	5 (40°C 40%)
BCGV-135	1345	850	700	-20°C -15°C	2	2	255	230 V - 50 Hz	R-290	606	540	-	4 (30°C 55%)
BCG-180	1795	850	700	-20°C -15°C	3	3	399	230 V - 50 Hz	R-290	606	556	D	4 (30°C 55%)
BCGV-180	1795	850	700	-20°C -15°C	3	3	399	230 V - 50 Hz	R-290	606	544	-	4 (30°C 55%)



BRG-225-V

EJEMPLO CUBETAS GN Y DOTACIÓN EXTRA
SAMPLE TRAYS GN AND EXTRA EQUIPMENT
EXEMPLE BACS GN ET EQUIPEMENTS COMPLÉMENTAIRES

OPCIONES · OPTIONS · OPTIONS

Parrilla suplemento	Supplement extra shelf	Grille additionnelle Supplement	21 € x ud
Parrilla adicional 530 X 325 GN1/1	530 X 325 GN1/1 extra shelf	Grille additionnelle 530 X 325 GN1/1	28 € x ud
Set adicional guías GN 1/1 340500006	GN 1/1 slides extra set	Kit supplémentaire de guides GN 1/1	30 € x set
Cajonera doble inox, auto-cierre	Double drawers set, self-closing	Tiroirs doubles inox, fermeture automatique	599 € x set
Cajonera triple inox, auto-cierre	Triple drawers set, self-closing	Tiroirs triple inox, fermeture automatique	790 € x set
Cerradura puerta inox	Solid door lock	Serrure à porte inox	25 € x ud
Cerradura puerta cristal	Glass door lock	Serrure à porte en verre	61 € x ud
Motor lado izquierdo	Left side engine	Moteur côté gauche	73 €
Encimera sin peto	No upstand worktop	Plan de travail sans panneau de protection	0 €
Set 4 ruedas	4 Castors set	Jeu 4 roulettes	98 € x set
Set 6 ruedas	6 Castors set	Jeu 6 roulettes	146 € x set
Evaporación automática	Automatic evaporation	Évaporation automatique	116 €
Registrador de alarmas HACCP	HACCP alarm recorder	Enregistreur d'alarme HACCP	consultar - consult - consulter
Tropicalizado 43°C	Tropicalized to 43°C	Tropicalisé 43°C	consultar - consult - consulter
Respaldo inox	Stainless steel rear side	Soutien en inox	consultar - consult - consulter
230V 60hz / 115v 60hz	230V 60hz / 115v 60hz	230V 60hz / 115v 60hz	consultar - consult - consulter

BRG-135 2.588 €	BRG-180 3.070 €	BRG-225 3.641 €	BRG-270 4.103 €
BCG-135 3.390 €	BCG-180 3.981 €		
BRG-135-V 2.982 €	BRG-180-V 3.602 €	BRG-225-V 4.321 €	BRG-270-V 4.980 €
BCG-135-V 3.812 €	BCG-180-V 4.605 €		
BRG-135-F 2.842 €	BRG-180-F 3.338 €	BRG-225-F 3.820 €	BRG-270-F 4.451 €

Características técnicas y constructivas sujetas a variación sin previo aviso. / We reserve the right to change specifications without prior notice. / Sujet technique et la conception de modifications sans préavis.

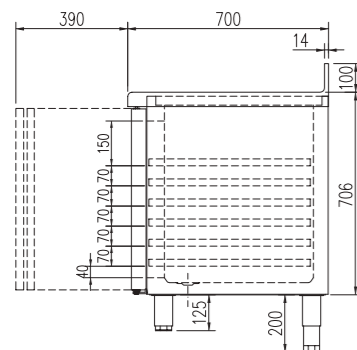

DETALLE PREINSTALACION
detailed pre-installation
détailée de pré-installation

Los modelos preinstalación NO incluyen valvulería, capilar y bandeja de evaporación automática
The preinstallation models do not include valves, capillary and automatic evaporation tray
Les modèles de préinstallation ne comprennent pas les vannes, capillaire et le plateau d'évaporation automatique

Ver características técnicas en página 250 / See technical data in page 250 / Voir caractéristiques techniques page 250

Modelo Model Modèle	Largo Length Longueur mm	Alto Height Hauteur mm	Fondo Depth Profondeur mm	Potencia Frig. Frig Power Puissance Frig. W	Capacidad Capacity Exposition L	Peso Neto Net Weight Poid Net Kg	Estantes Shelves Étagères	Pares de guías por puerta Sets of slides by door Kit de guides par porte	Voltaje Voltage Tension	Refrig. Coolant Frigorigène	Rango Range Gamme
BRGP / BRGPV-120	1045	850	700	300	255	75	2	2	230 V - 50 Hz	R-134a	-2°C+8°C
BRGP / BRGPV-170	1495	850	700	356	399	107	3	3	230 V - 50 Hz	R-134a	-2°C+8°C
BRGP / BRGPV-220	1945	850	700	485	543	139	4	4	230 V - 50 Hz	R-134a	-2°C+8°C
BRGP / BRGPV-270	2395	850	700	485	686	171	5	5	230 V - 50 Hz	R-134a	-2°C+8°C
BCGP / BCGPV-120	1045	850	700	353	255	75	2	2	230 V - 50 Hz	R-449A	-20°C-15°C
BCGP / BCGPV-170	1495	850	700	452	399	107	3	3	230 V - 50 Hz	R-449A	-20°C-15°C
BCGP / BCGPV-220	1945	850	700	610	543	139	4	4	230 V - 50 Hz	R-449A	-20°C-15°C



BRGP-220



BRGP-220-V

OPCIONES - OPTIONS - OPTIONS			
Parrilla suplemento	Supplement extra shelf	Grille additionnelle Supplement	21 € x ud
Parrilla adicional 530 X 325 GN1/1	530 X 325 GN1/1 extra shelf	Grille additionnelle 530 X 325 GN1/1	28 € x ud
Set adicional guías GN 1/1 340500006	GN 1/1 slides extra set	Kit supplémentaire de guides GN 1/1	30 € x set
Cajonera doble inox, auto-cierre	Double drawers set, self-closing	Tiroirs doubles inox, fermeture automatique	599 € x set
Cajonera triple inox, auto-cierre	Triple drawers set, self-closing	Tiroirs triple inox, fermeture automatique	790 € x set
Cerradura puerta inox	Solid door lock	Serrure à porte inox	25 € x ud
Cerradura puerta cristal	Glass door lock	Serrure à porte en verre	61 € x ud
Motor lado izquierdo	Left side engine	Moteur côté gauche	73 €
Encimera sin peto	No upstand worktop	Plan de travail sans panneau de protection	0 €
Set 4 ruedas	4 Castors set	Jeu 4 roulettes	98 € x set
Set 6 ruedas	6 Castors set	Jeu 6 roulettes	146 € x set
Evaporación automática	Automatic evaporation	Évaporation automatique	116 €
Registrador de alarmas HACCP	HACCP alarm recorder	Enregistreur d'alarme HACCP	consultar - consult - consulter
Tropicalizado 43°C	Tropicalized to 43°C	Tropicalisé 43°C	consultar - consult - consulter
Respaldo inox	Stainless steel rear side	Soutien en inox	consultar - consult - consulter
230V 60hz / 115v 60hz	230V 60hz / 115v 60hz	230V 60hz / 115v 60hz	consultar - consult - consulter

BRGP-120 1.970 €	BRGP-170 2.372 €	BRGP-220 2.881 €	BRGP-270 3.338 €
BCGP-120 2.138 €	BCGP-170 2.560 €	BCGP-220 3.003 €	
BRGP-120-V 2.290 €	BRGP-170-V 2.825 €	BRGP-220-V 3.466 €	BRGP-270-V 4.071 €
BCGP-120-V 2.573 €	BCGP-170-V 3.208 €	BCGP-220-V 3.850 €	

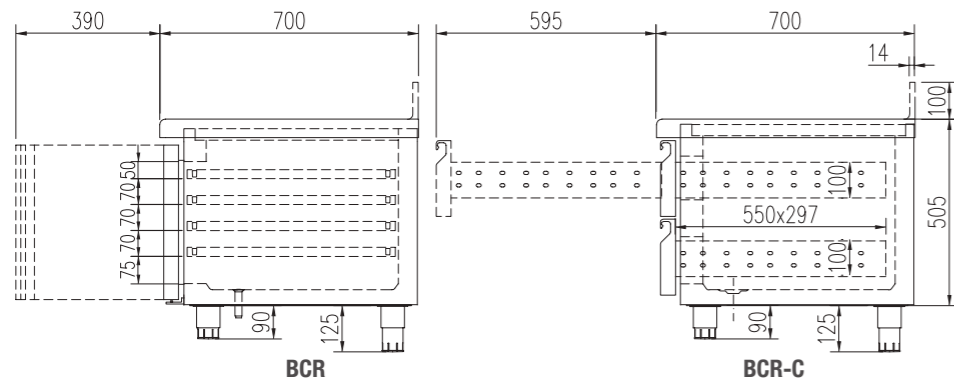

BCR-225



BCR-225-C

CARACTERÍSTICAS TÉCNICAS

- Cajoneras refrigeradas inox desmontables sobre guías inox telescópicas, sistema auto-cierre de serie

TECHNICAL DATA

- Stainless steel drawers with telescopic stainless steel slides for complete opening, self-closing system as standard

CARACTÉRISTIQUES TECHNIQUES

- Tiroirs réfrigérés démontables posés sur des rails télescopiques en inox ; système auto-bloquant de série



Ver características técnicas en página 250 / See technical data in page 250 / Voir caractéristiques techniques page 250

* Gas opcional / * Optional gas / * Gaz optionnel

Modelo Model Modèle	Largo Length Longueur mm	Alto Height Hauteur mm	Fondo Depth Profondeur mm	Rango Range Gamme	Estantes Shelves Étagères	Pares de guías Sets of slides Kit de guides	Capacidad Capacity Exposition L	Voltaje Voltage Tension	Refrig. Coolant Frigo	Potencia Frig. Frig Power Puissance Frig. W	Consumo Nominal Nominal Consumption Consommation Nominale W	Rango Range Gamme	clase climate 2015/1094 EN16825 Rango Range Gamme
BCR-135	1345	600	700	-2°C +8°C	2	2	169	230 V - 50 Hz	R-290	414	270	B	4 (30°C 55%)
BCR-180	1795	600	700	-2°C +8°C	3	3	264	230 V - 50 Hz	R-290	502	337	B	4 (30°C 55%)
BCR-225	2245	600	700	-2°C +8°C	4	4	359	230 V - 50 Hz	R-290	845	340	C	5 (40°C 40%)
BCR-270	2695	600	700	-2°C +8°C	5	5	454	230 V - 50 Hz	R-290	845	355	C	5 (40°C 40%)
BCR-135-C	1345	600	700	-2°C +8°C	1	1	169	230 V - 50 Hz	R-290	502	218	B	5 (40°C 40%)
BCR-180-C	1795	600	700	-2°C +8°C	1	1	264	230 V - 50 Hz	R-290	502	218	C	5 (40°C 40%)
BCR-225-C	2245	600	700	-2°C +8°C	1	1	359	230 V - 50 Hz	R-290	845	340	D	5 (40°C 40%)

OPCIONES · OPTIONS · OPTIONS

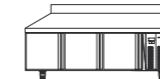
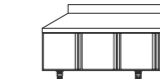
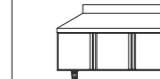
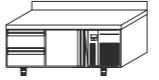
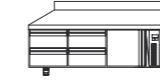
Parrilla adicional 530 X 325 GN1/1	530 X 325 GN1/1 extra shelf	Grille additionnelle 530 X 325 GN1/1	28 € x ud
Set adicional guías GN 1/1 340500006	GN 1/1 slides extra set	Kit supplémentaire de guides GN 1/1	30 € x set
Cerradura puerta inox	Solid door lock	Serrure à porte inox	25 € x ud
Cambio R-290 por R-134a	Change R-290 for R-134a	Changer le R-290 pour le R-134a	0 €
Cambio R-290 por R-452A	Change R-290 for R-452A	Changer le R-290 pour le R-452A	0 €
Encimera con peto	Worktop with upstand	Plan de travail sans panneau de protection	0 €
Set 4 ruedas	4 Castors set	Jeu 4 roulettes	98 € x set
Set 6 ruedas	6 Castors set	Jeu 6 roulettes	146 € x set
Motor lado izquierdo	Left side engine	Moteur côté gauche	73 €
Cambio 2 cajones 1/3 por uno 2/3	Change 2 1/3 drawers for one 2/3	Changer 2 tiroirs 1/3 pour un 2/3	Mismo precio - Same price - Même prix
Registrador de alarmas HACCP	HACCP alarm recorder	Enregistreur d'alarme HACCP	consultar - consult - consulter
Tropicalizado 43°C	Tropicalized to 43°C	Tropicalisé 43°C	consultar - consult - consulter
230V 60hz / 115v 60hz	230V 60hz / 115v 60hz	230V 60hz / 115v 60hz	consultar - consult - consulter

 BCR-135 2.535 €	 BCR-180 3.110 €	 BCR-225 3.790 €	 BCR-270 4.785 €
 BCR-135-C 2.775 €	 BCR-180-C 3.590 €	 BCR-225-C 4.510 €	 BCR-270-C 5.745 €

Características técnicas y constructivas sujetas a variación sin previo aviso. / We reserve the right to change specifications without prior notice. / Sujet technique et la conception de modifications sans préavis.

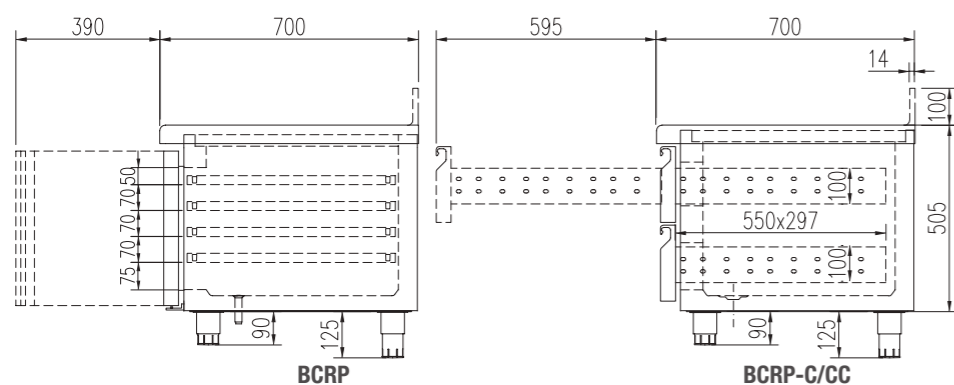

BCRP

BCRP-C/CC

CARACTERÍSTICAS TÉCNICAS

- Cajoneras refrigeradas inox desmontables sobre guías inox telescópicas, sistema auto-cierre de serie
- BCRP: Dotación de puertas
- BCRP-C: Dotación de cajoneras dobles + 1 puerta
- BCRP-CC: Dotación de cajoneras dobles + evaporadores centrales

TECHNICAL DATA

- Stainless steel drawers with telescopic stainless steel slides for complete opening, self-closing system as standard
- BCRP: Door provision
- BCRP-C: Provision of double drawers + 1 door
- BCRP-CC: Provision of double drawers + central evaporators

CARACTÉRISTIQUES TECHNIQUES

- Tiroirs réfrigérés démontables posés sur des rails télescopiques en inox ; système auto-bloquant de série
- BCRP : Fourniture de porte
- BCRP-C : Mise à disposition de tiroirs doubles + 1 porte
- BCRP-CC : Mise à disposition de doubles tiroirs + évaporateurs centraux

Ver características técnicas en página 250 / See technical data in page 250 / Voir caractéristiques techniques page 250

* Gas opcional / * Optional gas / * Gaz optionnel

Modelo Model Modèle	Largo Length Longueur mm	Alto Height Hauteur mm	Fondo Depth Profondeur mm	Rango Range Gamme	Estantes Shelves Étagères	Pares de guías Sets of slides Kit de guides	Capacidad Capacity Exposition L	Voltaje Voltage Tension	Potencia Frig. Frig Power Puissance Frig. W
BCRP-105	1045	600	700	-2°C +8°C	2	2	169	230 V - 50 Hz	178
BCRP-150	1495	600	700	-2°C +8°C	3	3	264	230 V - 50 Hz	245
BCRP-195	1945	600	700	-2°C +8°C	4	4	359	230 V - 50 Hz	304
BCRP-105-C	1045	600	700	-2°C +8°C	1	1	169	230 V - 50 Hz	178
BCRP-150-C	1495	600	700	-2°C +8°C	1	1	264	230 V - 50 Hz	245
BCRP-195-C	1945	600	700	-2°C +8°C	1	1	359	230 V - 50 Hz	304
BCRP-105-CC	1045	600	700	-2°C +8°C	0	0	169	230 V - 50 Hz	304
BCRP-150-CC	1495	600	700	-2°C +8°C	0	0	264	230 V - 50 Hz	485

OPCIONES - OPTIONS - OPTIONS

Parrilla adicional 530 X 325 GN1/1	530 X 325 GN1/1 extra shelf	Grille additionnelle 530 X 325 GN1/1	28 € x ud
Set adicional guías GN 1/1 340500006	GN 1/1 slides extra set	Kit supplémentaire de guides GN 1/1	30 € x set
Cerradura puerta inox	Solid door lock	Serrure à porte inox	25 € x ud
Encimera con peto	Worktop with upstand	Plan de travail sans panneau de protection	0 €
Set 4 ruedas	4 Castors set	Jeu 4 roulettes	98 € x set
Set 6 ruedas	6 Castors set	Jeu 6 roulettes	146 € x set
Motor lado izquierdo	Left side engine	Moteur côté gauche	73 €
Evaporación automática	Automatic evaporation	Évaporation automatique	180 €
Registrador de alarmas HACCP	HACCP alarm recorder	Enregistreur d'alarme HACCP	consultar - consult - consulter
230V 60hz / 115v 60hz	230V 60hz / 115v 60hz	230V 60hz / 115v 60hz	consultar - consult - consulter

Características técnicas y constructivas sujetas a variación sin previo aviso. / We reserve the right to change specifications without prior notice. / Sujet technique et la conception de modifications sans préavis.

MESA FRÍA GN 1/1, REFRIGERACIÓN BAJO COCINA PRE-INSTALACIÓN
PRE-INSTALLATION GN 1/1 COUNTER, CHILLER UNDER BROILER · TABLE RÉFRIGÉRÉE SOUS CUISINE
PRE-INSTALLATION TABLE RÉFRIGÉRÉE GN 1/1, RÉFRIGÉRATION SOUS CUISINE





BCRP-105-C



BCRP-150

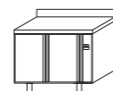
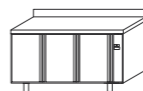

BCRP-195-C

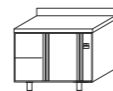
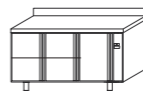
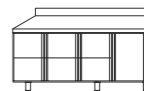
 BCRP-105 1.950 €	 BCRP-150 2.445 €	 BCRP-195 3.065 €
 BCRP-105-C 2.185 € BCRP-105-CC 2.425 €	 BCRP-150-C 2.926 € BCRP-150-CC 3.165 €	 BCRP-195-C 3.785 €

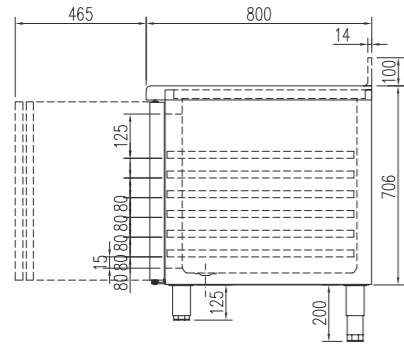

BPR-250

Ver características técnicas en página 250 / See technical data in page 250 / Voir caractéristiques techniques page 250

Modelo Model Modèle	Largo Length Longueur mm	Alto Height Hauteur mm	Fondo Depth Profondeur mm	Rango Range Gamme	Estantes Shelves Étagères	Pares de guías Sets of slides Kit de guides	Capacidad Capacity Exposition L	Voltaje Voltage Tension	Refrig. Coolant Frigorigène	Potencia Frig. Frig Power Puissance Frig. W	Consumo Nominal Nominal Consumption Consommation Nominale W	Rango Range Gamme	clase climate 2015/1094 EN16825 Rango Range Gamme
BPR-150	1495	850	800	-2°C +8°C	0	10	362	230 V - 50 Hz	R-290	502	235	A	5 (40°C 40%)
BPRV-150	1495	850	800	-2°C +8°C	0	10	362	230 V - 50 Hz	R-290	502	244	-	4 (30°C 55%)
BPR-200	2020	850	800	-2°C +8°C	0	15	562	230 V - 50 Hz	R-290	502	238	A	5 (40°C 40%)
BPRV-200	2020	850	800	-2°C +8°C	0	15	562	230 V - 50 Hz	R-290	502	251	-	4 (30°C 55%)
BPR-250	2545	850	800	-2°C +8°C	0	20	761	230 V - 50 Hz	R-290	845	370	B	5 (40°C 40%)
BPRV-250	2545	850	800	-2°C +8°C	0	20	761	230 V - 50 Hz	R-290	845	358	-	4 (30°C 55%)
BPC-150	1495	850	800	-20°C -15°C	0	10	362	230 V - 50 Hz	R-290	606	535	E	5 (40°C 40%)
BPCV-150	1495	850	800	-20°C -15°C	0	10	362	230 V - 50 Hz	R-290	606	544	-	4 (30°C 55%)
BPC-200	2020	850	800	-20°C -15°C	0	15	562	230 V - 50 Hz	R-290	606	556	E	4 (30°C 55%)
BPCV-200	2020	850	800	-20°C -15°C	0	15	562	230 V - 50 Hz	R-290	606	569	-	4 (30°C 55%)



BPR-250-V
EJEMPLO DOTACIÓN EXTRA
SAMPLE EXTRA EQUIPMENT
EXEMPLE EQUIPEMENTS COMPLEMENTAIRES



EJEMPLO GUÍAS PASTELERAS
EXAMPLE PASTRY GUIDES
EXEMPLE DE GUIDES DE PÂTISSERIE

OPCIONES - OPTIONS - OPTIONS

Parrilla suplemento	Supplement extra shelf	Grille additionnelle Supplement	28 € x ud
Parrilla 600 x 400	600 x 400 shelf	Grille 600 x 400	28 € x ud
Set adicional guías 600 x 400 340500004	600 X 400 slides extra set	Kit supplémentaire de guides 600 x 400	24 € x set
Cerradura puerta inox	Solid door lock	Serrure à porte inox	25 € x ud
Cerradura puerta cristal	Glass door lock	Serrure à porte en verre	61 € x ud
Motor lado izquierdo	Left side engine	Moteur côté gauche	73€
Encimera con peto	Worktop with upstand	Plan de travail sans panneau de protection	0 €
Cambio R-290 por R-134a	Change R-290 for R-134a	Changer le R-290 pour le R-134a	0 €
Cambio R-290 por R-452A	Change R-290 for R-452A	Changer le R-290 pour le R-452A	0 €
Set 4 ruedas	4 Castors set	Jeu 4 roulettes	98 € x set
Set 6 ruedas	6 Castors set	Jeu 6 roulettes	146 € x set
Evaporación automática	Automatic evaporation	Évaporation automatique	116 €
Cajonera doble inox, auto-cierre	Double drawers set, self-closing	Tiroirs doubles inox, fermeture automatique	742 €
Exterior blanco o negro	Black or white exterior	Extérieur noir ou blanc	consultar - consult-consulter
Registrador de alarmas haccp	Haccp alarm recorder	Enregistreur d'alarme HACCP	consultar - consult-consulter
Tropicalizado 43°C	Tropicalized to 43°C	Tropicalisé 43°C	consultar - consult-consulter
Respaldo inox	Stainless steel rear side	Soutien en inox	consultar - consult-consulter
Encimera de granito	Granite worktop	Plan de travail de granit	consultar - consult-consulter
230V 60hz / 115v 60hz	230V 60hz / 115v 60hz	230V 60hz / 115v 60hz	consultar - consult-consulter

BPR-150 2.881 €	BPR-200 3.445 €	BPR-250 4.156 €
BPC-150 3.573 €	BPC-200 4.183 €	
BPR-150-V 3.294 €	BPR-200-V 4.046 €	BPR-250-V 4.901 €
BPC-150-V 4.005 €	BPC-200-V 4.806 €	

Características técnicas y constructivas sujetas a variación sin previo aviso. / We reserve the right to change specifications without prior notice. / Sujet technique et la conception de modifications sans préavis.

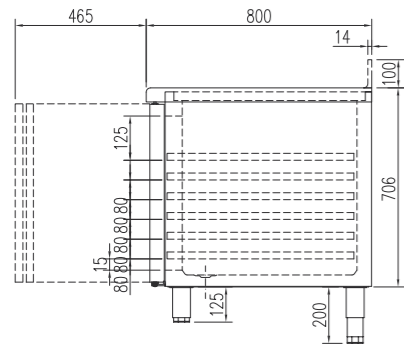

BPRP-220



BPRP-220-V
 EJEMPLO DOTACIÓN EXTRA
 SAMPLE EXTRA EQUIPMENT
 EXEMPLE EQUIPEMENTS COMPLEMENTAIRES

Ver características técnicas en página 250 / See technical data in page 250 / Voir caractéristiques techniques page 250

Modelo Model Modèle	Largo Length Longueur mm	Alto Height Hauteur mm	Fondo Depth Profondeur mm	Rango Range Gamme	Estantes Shelves Étagères	Pares de guías Sets of slides Kit de guides	Capacidad Capacity Exposition L	Voltaje Voltage Tension	Potencia Frig. Frig Power Puissance Frig. W
BPRP / BPRPV-120	1195	850	800	-2°C +8°C	0	9	255	230 V - 50 Hz	304
BPRP / BPRPV-170	1720	850	800	-2°C +8°C	0	14	399	230 V - 50 Hz	356
BPRP / BPRPV-220	2245	850	800	-2°C +8°C	0	19	543	230 V - 50 Hz	485
BPCP / BPCPV-120	1195	850	800	-20°C -15°C	0	9	255	230 V - 50 Hz	353
BPCP / BPCPV-170	1720	850	800	-20°C -15°C	0	14	399	230 V - 50 Hz	452
BPCP / BPCPV-220	2245	850	800	-20°C -15°C	0	19	543	230 V - 50 Hz	610

OPCIONES · OPTIONS · OPTIONS

Parrilla suplemento	Supplement extra shelf	Grille additionnelle Supplement	28 € x ud
Parrilla 600 x 400	600 x 400 shelf	Grille 600 x 400	28 € x ud
Set adicional guías 600 x 400 340500004	600 X 400 slides extra set	Kit supplémentaire de guides 600 x 400	24 € x set
Cerradura puerta inox	Solid door lock	Serrure à porte inox	25 € x ud
Cerradura puerta cristal	Glass door lock	Serrure à porte en verre	61 € x ud
Motor lado izquierdo	Left side engine	Moteur côté gauche	73€
Encimera sin peto	Worktop without upstand	Plan de travail sans panneau de protection	0 €
Set 4 ruedas	4 Castors set	Jeu 4 roulettes	98 €
Set 6 ruedas	6 Castors set	Jeu 6 roulettes	146 €
Evaporación automática	Automatic evaporation	Évaporation automatique	180 €
Registrador de alarmas haccp	Haccp alarm recorder	Enregistreur d'alarme HACCP	consultar - consult-consulter
Tropicalizado 43°C	Tropicalized to 43°C	Tropicalisé 43°C	consultar - consult-consulter
Respaldo inox	Stainless steel rear side	Soutien en inox	consultar - consult-consulter
230V 60hz / 115v 60hz	230V 60hz / 115v 60hz	230V 60hz / 115v 60hz	consultar - consult-consulter

Características técnicas y constructivas sujetas a variación sin previo aviso. / We reserve the right to change specifications without prior notice. / Sujet technique et la conception de modifications sans préavis.

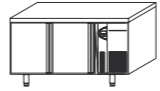
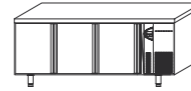
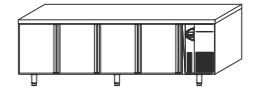
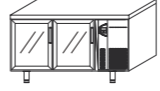
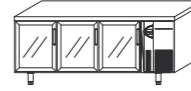
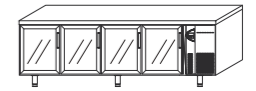
 BPRP-120 2.157 € BPCP-120 2.365 €	 BPRP-170 2.715 € BPCP-170 2.985 €	 BPRP-220 3.279 €
 BPRP-120-V 2.365 € BPCP-120-V 2.819 €	 BPRP-170-V 2.985 € BPCP-170-V 3.644 €	 BPRP-220-V 3.353 €

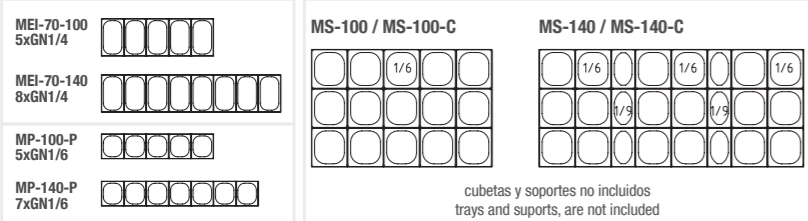
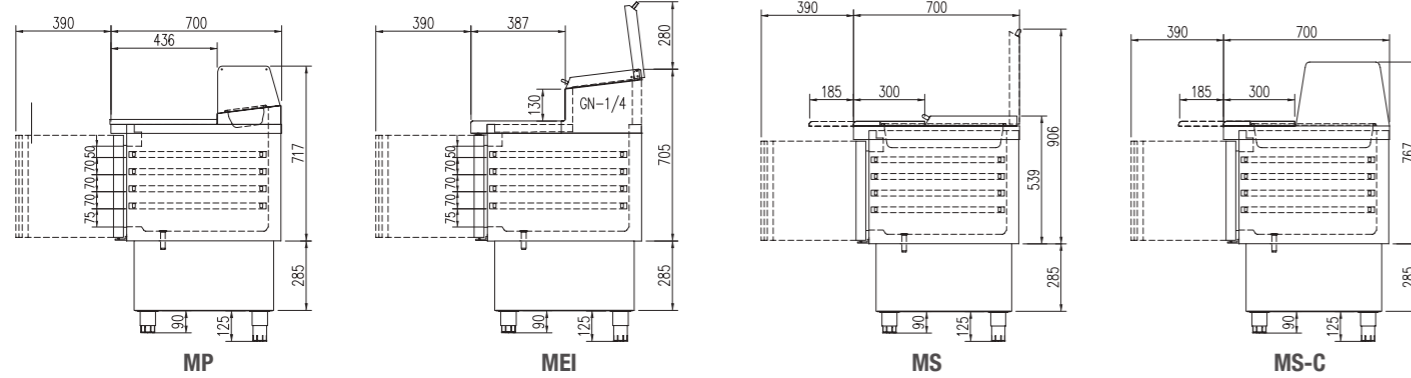

DETALLE MS

evaporador central



MP-140-P

CON CAJONES OPCIONALES
OPTIONAL DRAWERS
TIROIR EN OPTION



MEI-70-100



MS-100-C



MS-100

CARACTERÍSTICAS TÉCNICAS	TECHNICAL DATA	CARACTÉRISTIQUES TECHNIQUES
<ul style="list-style-type: none"> MP encimera granito, cúpula acristalada sobre alojamientos GN 1/6-100 MEI70 encimera inox, cubierta inox abatible sobre expositor ingredientes GN 1/4-150 MS cúpula acristalada sobre alojamiento cubetas MS-C cubierta inox abatible sobre alojamiento cubetas Estantes interiores GN 1/1 	<ul style="list-style-type: none"> MP granite working area and glass cover, GN 1/6-100 capacity MEI70 stainless steel worktop, topping unit with hinged lid, GN 1/4-150 capacity MS glass cover MS-C hinged lid Interior shelf GN 1/1 	<ul style="list-style-type: none"> MP Plan de travail en granit, vitrine en verre, capa-cité GN 1/6-100 MEI70 plan de travail en inox, couvercle en inox, rabattable sur présentoir à ingrédients GN ¼-150 MS vitrine en verre MS-C couvercle en inox Intérieur grille GN 1/1

Ver características técnicas en página 250 / See technical data in page 250 / Voir caractéristiques techniques page 250

Modelo Model Modèle	Largo Length Longueur mm	Alto Height Hauteur mm	Fondo Depth Profondeur mm	Rango Range Gamme	Perfiles GN GN Supports Profil GN	Estantes Shelves Étagères	Pares de guías Sets of slides Kit de guides	Capacidad Capacity Exposition L	Voltaje Voltage Tension	Refrig. Coolant Frigorigène	Potencia Frig. Frig Power Puissance Frig. W	Consumo Nominal Nominal Consumption Consommation Nominale W
MEI-70-100	925	890	700	0°C +8°C	-	2	2	169	230 V - 50 Hz	R-290	502	764
MEI-70-140	1375	890	700	0°C +8°C	-	3	3	264	230 V - 50 Hz	R-290	1004	614
MP-100-P	925	890	700	0°C +8°C	-	2	2	169	230 V - 50 Hz	R-290	502	764
MP-140-P	1375	890	700	0°C +8°C	-	3	3	264	230 V - 50 Hz	R-290	1004	614
MS-100	925	890	700	0°C +8°C	4	2	2	169	230 V - 50 Hz	R-290	502	764
MS-140	1375	890	700	0°C +8°C	7	3	3	264	230 V - 50 Hz	R-290	1004	614
MS-100-C	925	890	700	0°C +8°C	4	2	2	169	230 V - 50 Hz	R-290	502	764
MS-140-C	1375	890	700	0°C +8°C	7	3	3	264	230 V - 50 Hz	R-290	1004	614

OPCIONES · OPTIONS · OPTIONS			
Parrilla adicional 530 X 325 GN1/1	530 X 325 GN1/1 extra shelf	Grille additionnelle 530 X 325 GN1/1	28 € x ud
Set adicional guías GN 1/1 340500006	GN 1/1 slides extra set	Kit supplémentaire de guides GN 1/1	30 € x set
Cajonera doble inox, auto-cierre	Double drawers set, self-closing	Tiroirs doubles inox, fermeture automatique	537 € x set
Cerradura puerta inox	Solid door lock	Serrure à porte inox	25 €
Set 4 ruedas	4 Castors set	Jeu 4 roulettes	98 € x set
Registrador de alarmas haccp	Haccp alarm recorder	Enregistreur d'alarme HACCP	consultar - consult - consulter
230V 60hz / 115v 60hz	230V 60hz / 115v 60hz	230v 60Hz / 115v 60Hz	consultar - consult - consulter
Cambio R-290 por R-134a	Change R-290 for R-134a	Changer le R-290 pour le R-134a	0 €

Encimeras, alojamientos para cubetas y cubiertas, se pueden fabricar a medida.
Worktops, containers fits and covers, can be customized.
Les plans de travail, les récipients pour des bacs et couvercles, peuvent être personnalisés

Características técnicas y constructivas sujetas a variación sin previo aviso. / We reserve the right to change specifications without prior notice. / Sujet technique et la conception de modifications sans préavis.

MP-100-P 2.412 €	MEI-70-100 2.381 €	MS-100 2.283 €	MS-100-C 2.252 €
MP-140-P 2.911 €	MEI-70-140 2.881 €	MS-140 2.733 €	MS-140-C 2.714 €

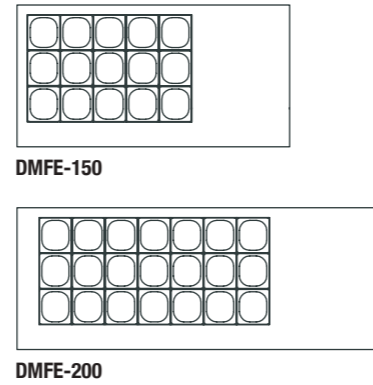
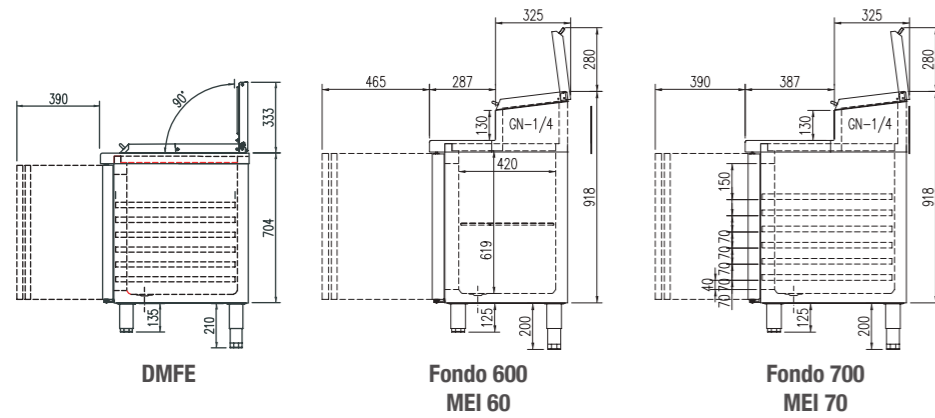

CARACTERÍSTICAS TÉCNICAS	TECHNICAL DATA	CARACTÉRISTIQUES TECHNIQUES
<ul style="list-style-type: none"> DMFE: Encimera inox con capacidad cubetas GN (ver detalle) y cubierta inox abatible y plegable MEI Encimera inox con expositor de ingredientes integrado y cubierta inox abatible Expositor ingredientes GN 1/4-150 MEI60 estantes interiores de alambre en acero plastificado, regulables en altura, sobre apoyos inox MEI70 estantes interiores GN 1/1 de alambre en acero plastificado, sobre guías de acero inox regulables en altura 	<ul style="list-style-type: none"> DMFE: AISI-304 stainless steel worktop, capacity for GN containers (see detail) with hinged stainless steel lid MEI AISI-30418/10 stainless steel worktop, raised topping well with hinged lid GN 1/4-150 topping unit MEI60 shelves made of plasticized steel wire, height adjustable MEI70 GN 1/1 shelves made of plasticized steel wire, height adjustable 	<ul style="list-style-type: none"> Plan de travail en inox avec capacité de bac GN (voir détail) et couvercle inox rabattable et repliable MEI Plan de travail en inox avec présentoir à ingrédients intégré et couvercle en inox rabattable Présentoir à ingrédients GN ¼-150 MFEI60 étagères intérieures de fil de fer plastifié, réglables en hauteur sur des appuis inox MFEI70 étagères intérieures GN 1/1 de fil de fer plastifié, réglables en hauteur, sur des glisses d'acier inox réglables en hauteur

Ver características técnicas en página 250 / See technical data in page 250 / Voir caractéristiques techniques page 250

* Gas opcional / * Optional gas / * Gaz optionnel

Modelo Model Modèle	Largo Length Longueur mm	Alto Height Hauteur mm	Fondo Depth Profondeur mm	Rango Range Gamme	Estantes Shelves Étagères	Pares de guías Sets of slides Kit de guides	Capacidad Capacity Exposition L	Perfiles GN Profile GN Profils GN 1/6	Capacidad GN Capacity GN Exposition 1/4	Voltaje Voltage Tension	Refrig. Coolant Frigorigène	Potencia Frig. Frig Power Puissance Frig. W	Consumo Nominal Nominal Consumption Consommation Nominale W
DMFE-150	1345	850	700	0°C +8°C	2	2	255	4		230 V - 50 Hz	R-290	502	490
DMFE-200	1795	850	700	0°C +8°C	3	3	399	6		230 V - 50 Hz	R-290	845	794
MEI60-150	1495	850	600	0°C +8°C	2	0	245		8	230 V - 50 Hz	R-290	502	264
MEI60-200	2020	850	600	0°C +8°C	3	0	380		12	230 V - 50 Hz	R-290	820	614
MEI70-135	1345	850	700	0°C +8°C	2	2	255		8	230 V - 50 Hz	R-290	502	264
MEI70-180	1795	850	700	0°C +8°C	3	3	399		10	230 V - 50 Hz	R-290	820	614
MEI70-225	2245	850	700	0°C +8°C	4	4	543		13	230 V - 50 Hz	R-290	820	614
MEI70-270	2695	850	700	0°C +8°C	5	5	686		16	230 V - 50 Hz	R-290	820	670

OPCIONES · OPTIONS · OPTIONS			
Parrilla adicional 530 X 325 GN1/1	530 X 325 GN1/1 extra shelf	Grille additionnelle 530 X 325 GN1/1	28 € x ud
Set adicional guías GN 1/1 340500006	GN 1/1 slides extra set	Kit supplémentaire de guides GN 1/1	30 € x set
Cajonera doble inox, auto-cierre	Double drawers set, self-closing	Tiroirs doubles, fermeture automatique	599 € x set
Cajonera triple inox, auto-cierre	Triple drawers set, self-closing	Tiroirs triples, fermeture automatique	790€ x set
Cerradura puerta inox	Solid door lock	Serrure à porte inox	25 € x ud
Motor lado izquierdo	Left side engine	Moteur côté gauche	73 €
Set 4 ruedas	4 Castors set	Jeu 4 roulettes	98 € x set
Set 6 ruedas	6 Castors set	Jeu 6 roulettes	146 € x set
Registrador de alarmas HACCP	HACCP alarm recorder	Enregistreur d'alarme HACCP	consultar - consult - consulter
Respaldo inox	Stainless steel rear side	Soutien en inox	consultar - consult - consulter
Encimera de granito	Granite worktop	Plan de travail en granit	consultar - consult - consulter
230v 60hz / 115v 60hz	230v 60hz / 115v 60hz	230v 60Hz / 115v 60Hz	consultar - consult - consulter

Encimeras, alojamientos para cubetas y cubiertas, se pueden fabricar a medida.
Worktops, containers fits and covers, can be customized.
Les plans de travail, les récipients pour des bacs et couvercles, peuvent être personnalisés

Características técnicas y constructivas sujetas a variación sin previo aviso. / We reserve the right to change specifications without prior notice. / Sujet technique et la conception de modifications sans préavis.



DMFE-200



MEI70-180

DMFE-150 3.132 €	DMFE-200 3.755 €
MEI70-135 3.258 €	MEI70-180 3.876 €
	MEI70-225 4.451 €

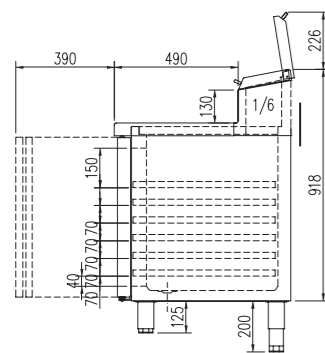

MEI-70

MEI-70-180-1/6
8xGN1/6



MEI-70-225-1/6
12xGN1/6



MEI-70-270-1/6
14xGN1/6



CARACTERÍSTICAS TÉCNICAS

- Encimera inox con expositor de ingredientes integrado y cubierta inox abatible
- Expositor ingredientes GN 1/6-150
- Modelo ST, sin tapa inox abatible sobre el alojamiento cubetas.

TECHNICAL DATA

- AISI-30418/10 stainless steel worktop, raised topping well with hinged lid
- GN 1/6-150 topping unit
- ST model, no lids

CARACTÉRISTIQUES TECHNIQUES

- Plan de travail en inox avec présentoir à ingrédients intégré et couvercle en inox rabattable
- Présentoir à ingrédients GN 1/6-150
- Modèle ST, sans couvercle en inox rabattable sur le récipient des bacs

Ver características técnicas en página 250 / See technical data in page 250 / Voir caractéristiques techniques page 250

* Gas opcional / * Optional gas / * Gaz optionnel

Modelo Model Modèle	Largo Length Longueur mm	Alto Height Hauteur mm	Fondo Depth Profondeur mm	Rango Range Gamme	Estantes Shelves Étagères	Pares de guías Sets of slides Kit de guides	Capacidad Capacity Exposition L	Capacidad GN Capacity GN Exposition GN 1/6	Voltaje Voltage Tension	Refrig. Coolant Frigorigène	Potencia Frig. Frig Power Puissance Frig. W	Consumo Nominal Nominal Consumption Consommation Nominale W
MEI-70-180	1795	850	700	0°C +8°C	3	3	399	10	230 V - 50 Hz	R-290	1004	614
MEI-70-225	2245	850	700	0°C +8°C	4	4	543	13	230 V - 50 Hz	R-290	1004	614
MEI-70-270	2695	850	700	0°C +8°C	5	5	686	14	230 V - 50 Hz	R-290	1004	670

OPCIONES · OPTIONS · OPTIONS

Parrilla adicional 530 X 325 GN1/1	530 X 325 GN1/1 extra shelf	Grille additionnelle 530 X 325 GN1/1	28 € x ud
Cerradura puerta inox	Solid door lock	Serrure à porte inox	25 € x ud
Motor lado izquierdo	Left side engine	Moteur côté gauche	73 €
Set 4 ruedas	4 Castors set	Jeu 4 roulettes	98 € x set
Set 6 ruedas	6 Castors set	Jeu 6 roulettes	146 € x set
Cajonera doble inox, auto-cierre	Double drawers set, self-closing	Tiroirs doubles inox, fermeture automatique	599 € x set
Cajonera triple inox, auto-cierre	Triple drawers set, self-closing	Tiroirs triple inox, fermeture automatique	790 € x set
Registrador de alarmas HACCP	HACCP alarm recorder	Enregistreur d'alarme HACCP	consultar - consult - consulter
Encimera de granito	Granite worktop	Plan de travail en granit	consultar - consult - consulter
Respaldo inox	Stainless steel rear side	Soutien en inox	consultar - consult - consulter
230V 60hz / 115v 60hz	230V 60hz / 115v 60hz	230v 60Hz / 115v 60Hz	consultar - consult - consulter

Encimeras, alojamientos para cubetas y cubiertas, se pueden fabricar a medida.
Worktops, containers fits and covers, can be customized.
Les plans de travail, les récipients pour des bacs et couvercles, peuvent être personnalisés

Características técnicas y constructivas sujetas a variación sin previo aviso. / We reserve the right to change specifications without prior notice. / Sujet technique et la conception de modifications sans préavis.



MEI-70-225-1/6

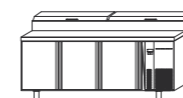

MEI-70-180-1/6 3.876 €

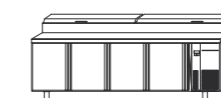

MEI-70-225-1/6 4.571 €

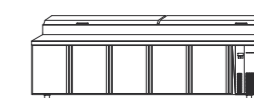

MEI-70-270-1/6 5.690 €

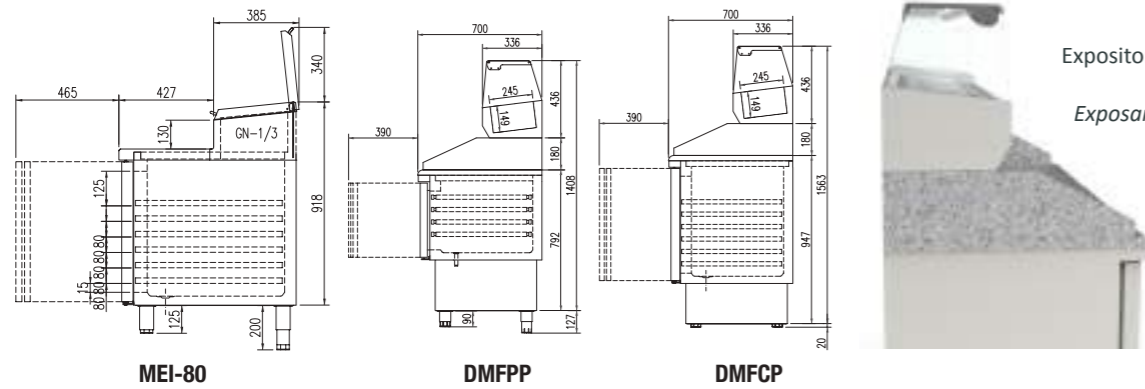

Expositor topping con iluminación LED
 LED lighting topping unit
 Expositant en tête avec éclairage LED



CARACTERÍSTICAS TÉCNICAS

- DMF Encimera de granito, con peto trasero y laterales de 180 mm
- DMF Expositor de ingredientes independiente, capacidad GN 1/4, incluido
- MEI-80 Encimera inox con expositor de ingredientes integrado y cubierta inox abatible
- MEI-80 Expositor ingredientes GN 1/3-150
- MEI-80 Estantes interiores 60x40 de alambre en acero plastificado, sobre guías de acero inox regulables en altura
- MEI-80 OPCIONAL: parrilla de trabajo 525x400 con bandeja recogedora

TECHNICAL DATA

- DMF Granite working surface with 180 mm up stands
- DMF GN 1/4 topping unit, included
- MEI-80 AISI-30418/10 stainless steel worktop, raised topping well with hinged lid
- MEI-80 GN 1/3-150 topping unit
- MEI-80 Capacity for 60x40 shelves, containers or trays by stainless steel slides, height adjustable
- MEI-80 OPTIONAL: 525x400 working grill with drip pan

CARACTÉRISTIQUES TECHNIQUES

- DMF Plan de travail en granit, avec pente arrière et côtés de 180 mm
- DMF Expositant les ingrédients séparés, GN 1/4 capacités, inclus
- MEI-80 Plan de travail en inox avec présentoir à ingrédients intégré et couvercle en inox rabattable
- MEI-80 Présentoir à ingrédients GN 1/3-150
- MEI-80 Étagères intérieures 60x40 de fil de fer plastifié, sur des glisses d'acier inox réglables en hauteur
- MEI-80 EN OPTION : grille de travail 525x400 avec plateau qui recueille

Ver características técnicas en página 250 / See technical data in page 250 / Voir caractéristiques techniques page 250

* Gas opcional / * Optional gas / * Gaz optionnel

Modelo / Model / Modèle	Largo / Length / Longueur mm	Alto / Height / Hauteur mm	Fondo / Depth / Profondeur mm	Rango / Range / Gamme	Estantes / Shelves / Étagères	Pares de guías / Sets of slides / Kit de guides	Capacidad / Capacity / Exposition L	Capacidad GN / Capacity GN / Exposition GN	Voltaje / Voltage / Tension	Refrig. / Coolant / Frigorigène	Potencia Frig. / Frig Power / Puissance Frig. W	Consumo Nominal / Nominal Consumption / Consommation Nominale W
MEI-80-150	1495	850	800	0°C +8°C	2	2	362	GN 1/4: 8 uds	230 V - 50 Hz	R-290	502	764
MEI-80-200	2020	850	800	0°C +8°C	3	3	562	GN 1/4: 10 uds	230 V - 50 Hz	R-290	1004	614
DMFPP-140	1370	890	700	0°C +8°C	3	3	264	GN 1/4: 5 uds	230 V - 50 Hz	R-290	1004	614
DMFCP-140	1370	970	700	0°C +8°C	3	3	399	GN 1/4: 5 uds	230 V - 50 Hz	R-290	1004	614

OPCIONES · OPTIONS · OPTIONS

Parrilla adicional 530 X 325 GN1/1	530 X 325 GN1/1 extra shelf	Grille additionnelle 530 X 325 GN1/1	28 € x ud
Set adicional guías GN 1/1	GN 1/1 slides extra set	Jeu supplémentaire glisses GN 1/1	30 € x set
Cajonera doble inox, auto-cierre	Double drawers set, self-closing	Tiroirs doubles en inox, fermeture automatique	599 € x set
Cajonera triple inox, auto-cierre	Triple drawers set, self-closing	Tiroirs triples en inox, fermeture automatique	799 € x set
Cerradura puerta inox	solid door lock	Serrure à porte inox	25 € x ud
Set 4 ruedas	4 castors set	Jeu 4 roulettes	98 € x set
Parrilla + bandeja trabajo 500x400	Grill + tray 500x400	Grille + plateau de travail 500x400	187 € x ud
Motor lado izquierdo	Left side engine	Moteur côté gauche	73 €
Set 6 ruedas	6 Castors set	Jeu 6 roulettes	146 € x set
Registrador de alarmas HACCP	HACCP alarm recorder	Enregistreur d'alarme HACCP	consultar - consult - consulter
Encimera de granito	Granite worktop	Plan de travail en granit	consultar - consult- consulter
Respaldo inox	Stainless steel rear side	Soutien en inox	consultar - consult- consulter
230v 60Hz / 115v 60Hz	230v 60Hz / 115v 60Hz	230v 60Hz / 115v 60Hz	consultar - consult - consulter

Encimeras, alojamientos para cubetas y cubiertas, se pueden fabricar a medida.
 Worktops, containers fits and covers, can be customized.
 Les plans de travail, les récipients pour des bacs et couvercles, peuvent être personnalisés

Características técnicas y constructivas sujetas a variación sin previo aviso. / We reserve the right to change specifications without prior notice. / Sujet technique et la conception de modifications sans préavis.



Encimera granito opcional
 Optional granite worktop
 Comptoir de granit en option



Bandeja y parrilla de trabajo, opcionales
 with working grills and trays, optional
 plateau et grille de travail, en option

MEI-80-200



DMFPP-140



DMFCP-140

	MEI-80-150	3.714 €		MEI-80-200	4.290 €
	DMFPP-140	3.820 €		DMFCP-140	4.518 €

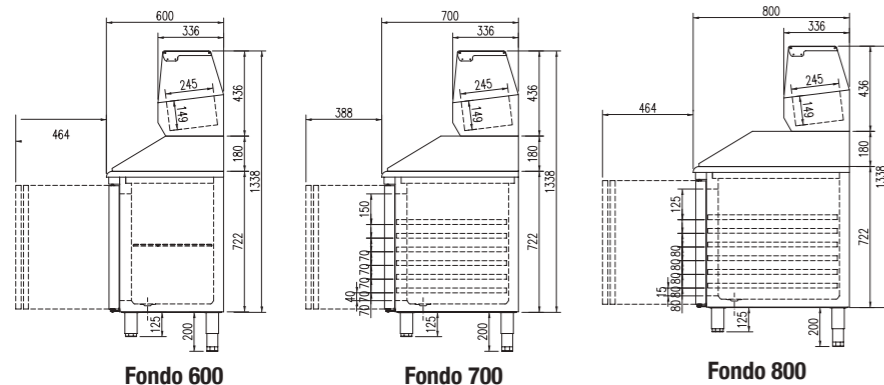

Detalle encimera granito
granite countertop detail
Détail de comptoir en granit



MP-70-225-R



MP-60-150-R

CARACTERÍSTICAS TÉCNICAS	TECHNICAL DATA	CARACTÉRISTIQUES TECHNIQUES
<ul style="list-style-type: none"> Encimera de granito, con peto trasero y laterales de 180 mm Expositor de ingredientes independiente, capacidad GN 1/4, incluido MP60 estantes interiores de alambre en acero plastificado, regulables en altura, sobre apoyos inox MP70 estantes interiores GN 1/1 de alambre en acero plastificado, sobre guías de acero inox regulables en altura 	<ul style="list-style-type: none"> Granite working surface with 180 mm up stands GN 1/4 topping unit, included MR60 shelves made of plasticized steel wire, height adjustable MR70 shelves made of plasticized steel wire, height adjustable 	<ul style="list-style-type: none"> Plan de travail en granit, avec pente arrière et côtés de 180 mm Évaporation automatique des eaux de dégivrage MR60 étagères intérieures avec en fil de fer plasti-fi é, réglables en hauteur sur appuis en inox MR70 étagères intérieures GN 1/1 en fil de fer plasti-fi é, sur des glisses en acier inox réglables en hauteur

Ver características técnicas en página 250 / See technical data in page 250 / Voir caractéristiques techniques page 250

* Gas opcional / * Optional gas / * Gaz optionnel

Modelo Model Modèle	Largo Length Longueur mm	Alto Height Hauteur mm	Fondo Depth Profondeur mm	Rango Range Gamme	Estantes Shelves Étagères	Pares de guías Sets of slides Kit de guides	Cajas Containers Boîtes 40x60	Capacidad Capacity Exposition L	Capacidad GN Capacity GN Exposition GN 1/4	Voltaje Voltage Tension	Refrig. Coolant Frigorigène	Potencia Frig. Frig Power Puissance Frig. W	Consumo Nominal Nominal Consumption Consommation Nominale W
MP-60-150-R	1495	850	600	0°C +8°C	2	0	0	245	6	230 V - 50 Hz	R-290	502	235
MP-60-200-R	2020	850	600	0°C +8°C	3	0	0	380	9	230 V - 50 Hz	R-290	502	238
MP-60-250-R	2545	850	600	0°C +8°C	4	0	0	516	12	230 V - 50 Hz	R-290	845	355
MP-70-135-R	1345	850	700	0°C +8°C	2	2	0	255	5	230 V - 50 Hz	R-290	502	235
MP-70-180-R	1795	850	700	0°C +8°C	3	3	0	399	8	230 V - 50 Hz	R-290	502	238
MP-70-225-R	2245	850	700	0°C +8°C	4	4	0	543	10	230 V - 50 Hz	R-290	845	355
MP-80-150-R	1495	850	800	0°C +8°C	0	8	3	362	6	230 V - 50 Hz	R-290	502	235
MP-80-200-R	2020	850	800	0°C +8°C	0	13	3	562	9	230 V - 50 Hz	R-290	502	238
MP-80-250-R	2545	850	800	0°C +8°C	0	18	3	761	12	230 V - 50 Hz	R-290	845	355

OPCIONES PARA MP - OPTIONS FOR MP - OPTIONS POUR MP			
Cerradura puerta inox	Solid door lock	Serrure à porte inox	25 € x ud
Motor lado izquierdo	Left side engine	Moteur côté gauche	73 €
Set 4 ruedas	4 Castors set	Jeu 4 roulettes	98 € x set
Set 6 ruedas	6 Castors set	Jeu 6 roulettes	146 € x set
Registrador de alarmas haccp	Haccp alarm recorder	Enregistreur d'alarme HACCP	consultar - consult- consulter
Respaldo inox	Stainless steel rear side	Soutien en inox	consultar - consult- consulter
230V 60hz / 115v 60hz	230V 60hz / 115v 60hz	230v 60Hz / 115v 60Hz	consultar - consult- consulter

	MP-60-150-R 3.808 €		MP-60-200-R 4.384 €		MP-60-250-R 5.135 €
	MP-70-135-R 4.010 €		MP-70-180-R 4.739 €		MP-70-225-R 5.410 €
	MP-80-150-R 4.437 €		MP-80-200-R 5.350 €		MP-80-250-R 5.732 €

Características técnicas y constructivas sujetas a variación sin previo aviso. / We reserve the right to change specifications without prior notice. / Sujet technique et la conception de modifications sans préavis.

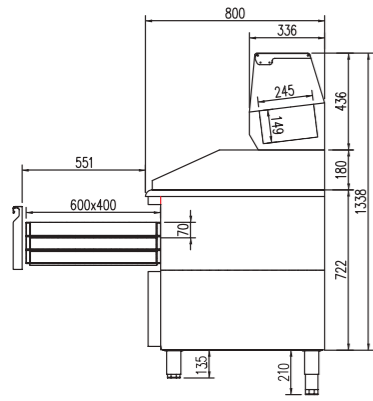

Detalle cubetas GN (No incluidas)
Buckets detail GN (Not included)
Détail cuvettes GN (Non inclus)



Detalle apertura cajon
Opening detail drawer
Détail l'ouverture du tiroir



MP-80-160-R

CARACTERÍSTICAS TÉCNICAS

- Encimera de granito, con peto trasero y laterales de 180 mm
- Expositor de ingredientes incluido, capacidad cubetas GN 1/4, (No incluidas)
- Interior con guías de acero inox, regulables en altura para parrillas, bandejas o contenedores 60x40x7 (4 en dotación)
- Cajon neutro con 3 cajas plasticas 60x40x7 en dotación

TECHNICAL DATA

- Granite working surface with 180 mm up stands
- Ingredient display included, capacity GN 1/4 cuvettes, (Not included)
- Inner with stainless steel guides, adjustable in height for grills, trays or containers 60x40x7 (4 supplied)
- Neutral drawer with 3 plastic boxes 60x40x7 in endowment

CARACTÉRISTIQUES TECHNIQUES

- Plan de travail en granit, avec pente arrière et côtés de 180 mm
- Ingrédients exposants inclus Capacité 1/4 bacs GN (non inclus)
- Intérieur de guidage en acier inoxydable, des supports réglables en hauteur, des plateaux ou récipients 60x40x7 (4 fournis)
- Cajon neutre avec 3 boîtes en plastique fourni 60x40x7

Ver características técnicas en página 250 / See technical data in page 250 / Voir caractéristiques techniques page 250

* Gas opcional / * Optional gas / * Gaz optionnel

Modelo Model Modèle	Largo Length Longueur mm	Alto Height Hauteur mm	Fondo Depth Profondeur mm	Rango Range Gamme	Estantes Shelves Étagères	Pares de guías Sets of slides Kit de guides	Cajas Refrigeradas Refrigerated boxes Boîtes réfrigéré	Cajas Neutras Neutral boxes Boîtes neutres	Capacidad Capacity Exposition L	Voltaje Voltage Tension	Refrig. Coolant Frigorigène	Potencia Frig. Frig Power Puissance Frig. W	Consumo Nominal Nominal Consumption Consommation Nominale W
MP-80-160-R	1565	850	800	0°C +8°C	0	8	3	3	362	230 V - 50 Hz	R-290	502	235
MP-80-210-R	2090	850	800	0°C +8°C	0	13	3	3	562	230 V - 50 Hz	R-290	502	238
MP-80-265-R	2615	850	800	0°C +8°C	0	16	3	3	761	230 V - 50 Hz	R-290	845	355

OPCIONES - OPTIONS - OPTIONS

Cerradura puerta inox	Solid door lock	Serrure à porte inox	28 € x ud
Motor lado izquierdo	Left side engine	Moteur côté gauche	73 €
Set 4 ruedas	4 Castors set	Jeu 4 roulettes	98 € x set
Set 6 ruedas	6 Castors set	Jeu 6 roulettes	146 € x set
Parrilla 60x40	60x40 shelf	Grille 60x60	28 €
Cajón plástico 60x40x7	60x40x7 plastic container	tiroir en matière plastique 60x40x7	35 € x ud
Cajón plástico 60x40x12	60x40x12 plastic container	tiroir en matière plastique 60x40x12	45 € x ud
Registrador de alarmas haccp	Haccp alarm recorder	Enregistreur d'alarme HACCP	consultar - consult- consulter
Respaldo inox	Stainless steel rear side	Soutien en inox	consultar - consult- consulter
230V 60hz / 115v 60hz	230V 60hz / 115v 60hz	230v 60Hz / 115v 60Hz	consultar - consult- consulter

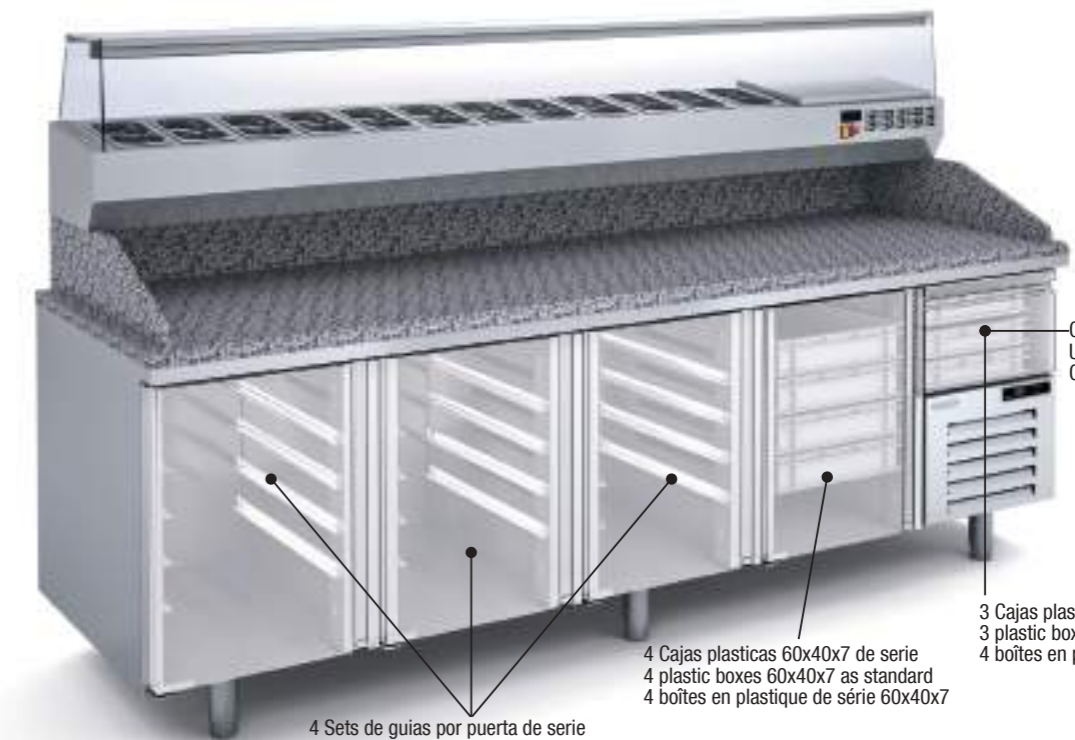

Cajon no refrigerado
Uncooled drawer
Cajon non refroidi

MP-80-265-R

4 Sets de guías por puerta de serie
4 Sets of guides per standard door
4 séries par séries de guides de porte

3 Cajas plasticas 60x40x7 de serie
3 plastic boxes 60x40x7 as standard
4 boîtes en plastique de série 60x40x7

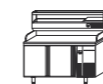

MP-80-160-R **4.533 €**

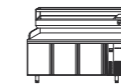

MP-80-210-R **5.295 €**

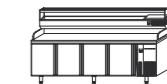

MP-80-265-R **6.072 €**

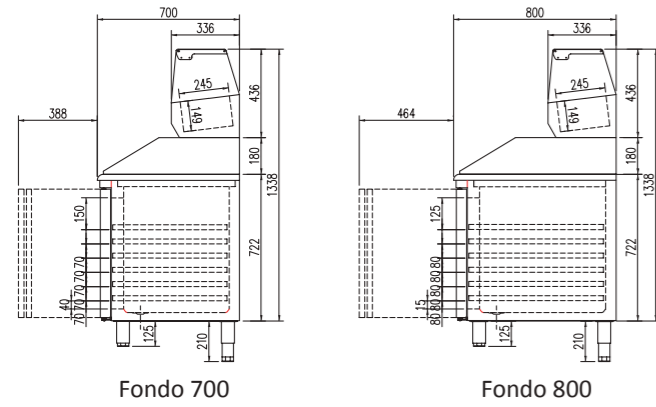

Detalle set 7 cajones opcional
Detail set 7 drawers optional
7 tiroirs détail en option



MPC-70-225

1 Parrilla + juego guías GN 1/1 por puerta de serie
1 Grill + set GN 1/1 guides per standard door
1 Grill + guide jeu GN 1/1 par porte standard

4 Cajones neutros
4 Neutral drawers
4 tiroirs neutres



MPC-80-250

5 Sets de guías por puerta de serie
5 Sets of guides per standard door
5 séries par séries de guides de porte

4 Cajones neutros + 5 cajas plasticas 60x45x7 de serie
4 Neutral drawers, plastic boxes not included
4 Tiroirs neutres + 5 boîtes en plastique de 60x45x7 série

CARACTERÍSTICAS TÉCNICAS

- Encimera de granito, con peto trasero y laterales de 180 mm
- Expositor de ingredientes incluido, capacidad cubetas GN 1/4, (No incluidas)
- Interior con guías de acero inox, regulables en altura para parrillas, bandejas o contenedores
- Cuerpo cajonero neutro, 4 cajones sobre guías telescópicas desmontables

TECHNICAL DATA

- Granite working surface with 180 mm up stands
- Ingredient display included, capacity GN 1/4 cuvettes, (Not included)
- Inner with stainless steel guides, adjustable in height for grills, trays or containers
- Neutral drawer body, 4 drawers on removable telescopic guides

CARACTÉRISTIQUES TECHNIQUES

- Plan de travail en granit, avec pente arrière et côtés de 180 mm
- Ingrédients exposants inclus Capacité 1/4 bacs GN (non inclus)
- Intérieur de guidage en acier inoxydable, des supports réglables en hauteur, des plateaux ou récipients
- Corps cajonero neutre, 4 tiroirs amovibles sur glissières télescopiques

Ver características técnicas en página 250 / See technical data in page 250 / Voir caractéristiques techniques page 250

* Gas opcional / * Optional gas / * Gaz optionnel

Modelo Model Modèle	Largo Length Longueur mm	Alto Height Hauteur mm	Fondo Depth Profondeur mm	Rango Range Gamme	Estantes Shelves Étagères	Pares de guías Sets of slides Kit de guides	Cajas Containers Boîtes 40x60	Capacidad Capacity Exposition L	Capacidad GN GN Capacity Exposition GN Uds	Voltaje Voltage Tension	Refrig. Coolant Frigorigène	Potencia Frig. Frig Power Puissance Frig. W	Consumo Nominal Nominal Consumption Consommation Nominale W
MPC-70-180	1795	850	700	0°C +8°C	2	2	0	255	8	230 V - 50 Hz	R-290	502	235
MPC-70-225	2245	850	700	0°C +8°C	3	3	0	399	10	230 V - 50 Hz	R-290	502	238
MPC-80-200	2020	850	800	0°C +8°C	0	10	5	362	9	230 V - 50 Hz	R-290	502	235
MPC-80-250	2545	850	800	0°C +8°C	0	15	5	562	12	230 V - 50 Hz	R-290	502	238

OPCIONES - OPTIONS - OPTIONS

Parrilla adicional 530 X 325 GN1/1	530 X 325 GN1/1 extra shelf	Grille additionnelle 530 X 325 GN1/1	25 € x ud
Set 7 cajones en gama 800	7 drawers set in range 800	7 tiroirs dans la gamme 800	270 €
Cerradura puerta inox	Solid door lock	Serrure à porte inox	25 € x ud
Motor lado izquierdo	Left side engine	Moteur côté gauche	73 €
Set 4 ruedas	4 Castors set	Jeu 4 roulettes	98 € x set
Set 6 ruedas	6 Castors set	Jeu 6 roulettes	146 € x set
Registrador de alarmas haccp	Haccp alarm recorder	Enregistreur d'alarme HACCP	consultar - consult- consulter
Respaldo inox	Stainless steel rear side	Soutien en inox	consultar - consult- consulter
230V 60hz / 115v 60hz	230V 60hz / 115v 60hz	230v 60Hz / 115v 60Hz	consultar - consult- consulter

Características técnicas y constructivas sujetas a variación sin previo aviso. / We reserve the right to change specifications without prior notice. / Sujet technique et la conception de modifications sans préavis.

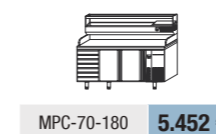

MPC-70-180 **5.452 €**

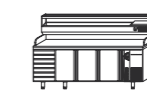

MPC-70-225 **6.221 €**

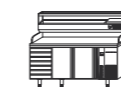

MPC-80-200 **5.504 €**

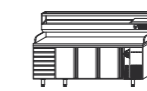

MPC-80-250 **6.624 €**

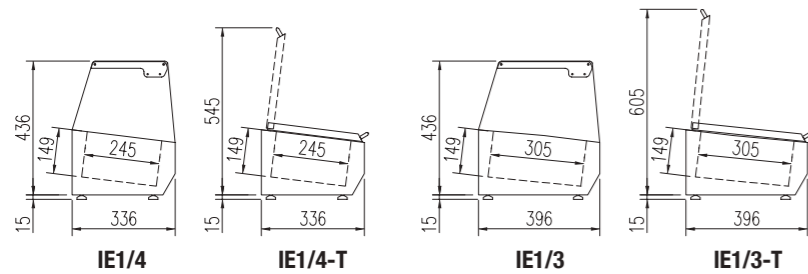

Detalle tapa cerrada
Closed lid detail
Détail du couvercle fermé

CARACTERÍSTICAS TÉCNICAS IE	TECHNICAL DATA IE	CARACTÉRISTIQUES TECHNIQUES IE
<ul style="list-style-type: none"> Exterior e interior en acero inox AISI-304 18/10 Capacidad para cubetas GN no incluidas Apoyos regulables en altura Evaporador por placa fría Aislamiento de poliuretano inyectado, densidad 40 Kg/m³, bajo GWP y cero efecto ODP Control digital de temperatura y descargas, eficiente en la gestión del consumo de energía Temperatura de trabajo +2°C +8°C a 32°C ambiente El cúpula de cristal EI T cubierta inox abatible 	<ul style="list-style-type: none"> AISI-304 18/10 stainless steel exterior and interior GN containers capacity, not included Adjustable supports Cold plate evaporator 40 Kg/m³ density polyurethane insulation, low GWP and zero ODP effect Energy efficient digital controller of temperature and defrosts Operating temperature +2°C +8°C , 32°C ambient El glass cover options EI-T hinged stainless steel cover 	<ul style="list-style-type: none"> Extérieur en acier inoxydable AISI 304 18/10, Possibilité d'intégrer bacs, GN non inclus. Supports réglables en hauteur. Evaporateur avec système de plaque froide. Isolation à base de polyuréthane injecté, densité 40 kg/m³, faible GWP et aucun effet ODP. Le Contrôle digital de température ainsi que le dégivrage automatique œuvre à une meilleure gestion de la consommation énergétique. Température de travail +4°C à +8°C, à 32°C de température ambiante. IE : dôme en verre IE T: Couvercle en inox rabattable



IE 1/4-200-T

* Gas opcional / * Optional gas / * Gaz optionnel

Modelo Model Modèle	Largo Length Longueur mm	Fondo Depth Profondeur mm	Rango Range Gamme	Capacidad Capacity Exposition GN 1/4	Capacidad Capacity Exposition GN 1/3	Voltaje Voltage Tension	Refrig. Coolant Frigorigène	Potencia Frig. Frig Power Puissance Frig. W	Consumo Nominal Nominal Consumption Consommation Nominale W (IE-T)	Consumo Nominal Nominal Consumption Consommation Nominale W (IE)
IE-1/4-135	1345	336	+2°C +8°C	5	0	230 V - 50 Hz	R-290	158	131	152
IE-1/4-150	1495	336	+2°C +8°C	6	0	230 V - 50 Hz	R-290	170	134	155
IE-1/4-180	1795	336	+2°C +8°C	8	0	230 V - 50 Hz	R-290	190	136	162
IE-1/4-200	2020	336	+2°C +8°C	9	0	230 V - 50 Hz	R-290	200	138	180
IE-1/4-225	2245	336	+2°C +8°C	10	0	230 V - 50 Hz	R-290	502	203	245
IE-1/4-250	2545	336	+2°C +8°C	12	0	230 V - 50 Hz	R-290	502	203	245
IE-1/3-135	1345	396	+2°C +8°C	0	5	230 V - 50 Hz	R-290	158	131	152
IE-1/3-150	1495	396	+2°C +8°C	0	5	230 V - 50 Hz	R-290	170	134	155
IE-1/3-180	1795	396	+2°C +8°C	0	7	230 V - 50 Hz	R-290	190	136	162
IE-1/3-200	2020	396	+2°C +8°C	0	8	230 V - 50 Hz	R-290	200	138	180
IE-1/3-225	2245	396	+2°C +8°C	0	10	230 V - 50 Hz	R-290	502	203	245
IE-1/3-250	2545	396	+2°C +8°C	0	11	230 V - 50 Hz	R-290	502	203	245



IE 1/3-180

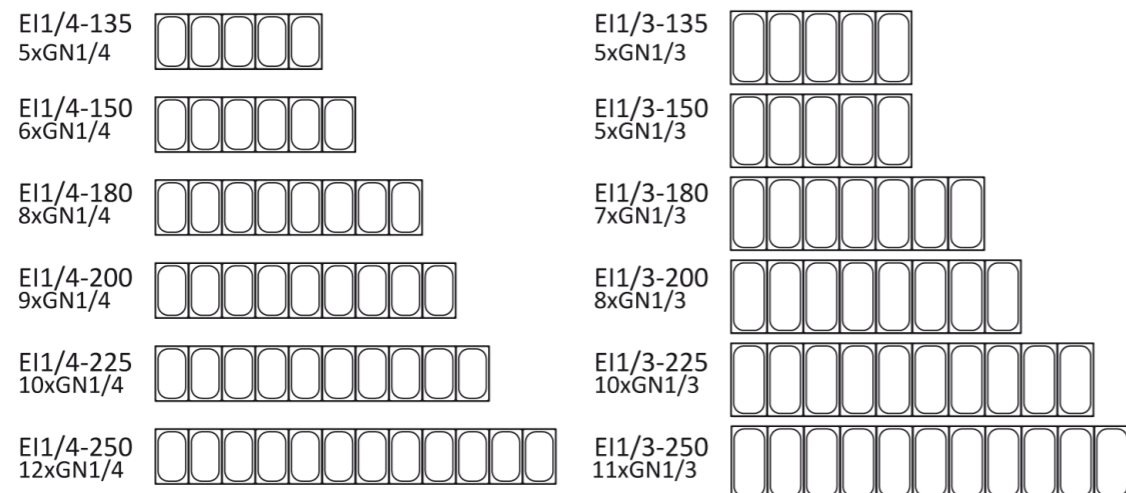

IE-1/4-135-T 1.320 €	IE-1/4-150-T 1.367 €	IE-1/4-180-T 1.488 €	IE-1/4-200-T 1.521 €	IE-1/4-225-T 1.649 €	IE-1/4-250-T 1.736 €
IE-1/3-135-T 1.386 €	IE-1/3-150-T 1.435 €	IE-1/3-180-T 1.554 €	IE-1/3-200-T 1.595 €	IE-1/3-225-T 1.728 €	IE-1/3-250-T 1.810 €
IE-1/4-135 1.499 €	IE-1/4-150 1.521 €	IE-1/4-180 1.629 €	IE-1/4-200 1.688 €	IE-1/4-225 1.769 €	IE-1/4-250 1.889 €
IE-1/3-135 1.554 €	IE-1/3-150 1.583 €	IE-1/3-180 1.689 €	IE-1/3-200 1.750 €	IE-1/3-225 1.798 €	IE-1/3-250 1.877 €

Características técnicas y constructivas sujetas a variación sin previo aviso. / We reserve the right to change specifications without prior notice. / Sujet technique et la conception de modifications sans préavis.

7 ARMARIOS CABINET ARMOIRE



CARACTERÍSTICAS TÉCNICAS

- Exterior en acero inox AISI-304 18/10, excepto el respaldo
- Interior en acero inox AISI-304 18/10, con aristas curvas y fondo embutido
- Puertas de vidrio con serigrafía mínima gris oscuro con apertura reversible, con sistema de cierre automático y burlete magnético (permanece abierta al superar los 90° de apertura)
- Contrapuerta inox embutida
- Luz interior
- Estantes interiores de varilla en acero plastificado, regulables en altura
- Pies en tubo de acero inox ajustables en altura 125-200 mm
- Cuadro de mandos y rejilla ventilación motor, desmontables
- Unidad condensadora ventilada
- Evaporador sistema tiro forzado, con recubrimiento anticorrosión
- Paro ventiladores tiro forzado al abrir la puerta
- Evaporación automática del agua de descarche
- Aislamiento de poliuretano inyectado, densidad 40 Kg/m³, bajo GWP y cero efecto ODP
- Control digital de temperatura y descarches, eficiente en la gestión del consumo de energía
- Temperatura de trabajo a 32°C ambiente

TECHNICAL DATA

- AISI-304 18/10 stainless steel exterior, except the rear side
- AISI-304 18/10 stainless steel interior, stamped bottom and rounded corners
- Glass doors with minimal dark gray serigraphy with reversible opening, with automatic closing system and magnetic weather stripping (remains open when opening more than 90°)
- Rear-door by stamped steel
- Interior lighting
- Shelves made of plasticized steel wire, height adjustable
- AISI-304 18/10 adjustable legs, 125 to 200 mm
- Control panel and engine ventilation grill, removable
- Fan assisted condenser unit
- Fan assisted evaporator, with anticorrosion coating
- Evaporator fan stops when door is opened
- Automatic evaporation of defrost water
- 40 Kg/m³ density polyurethane insulation, low GWP and zero ODP effect
- Energy efficient digital controller of temperature and defrosts
- Operating temperature 32°C ambient

CARACTÉRISTIQUES TECHNIQUES

- Extérieur en acier inox AISI 304 18/10, à l'exception de la partie arrière
- Intérieur en acier inox AISI 304 18/10, avec bords incurvés et bac encastré.
- Portes en verre avec sérigraphie minimale gris foncé à ouverture réversible, avec système de fermeture automatique et coupe-froid magnétique (reste ouvert lors d'une ouverture à plus de 90°)
- Contreporte en Inox encastrée
- Lumière intérieure
- Étagères intérieures avec Fils d'acier plastifiés, réglables en hauteur.
- Pies en tube d'acier inoxydable réglables en hauteur 125 - 200 mm
- Tableau de bord et grille de ventilation du moteur amovibles
- Unité de condensation ventilée
- Evaporateurs avec système de marche forcée et recouvrement anticorrosion.
- Arrêt automatique des ventilateurs et du système de marche forcée à l'ouverture de la porte.
- Evaporation automatique des eaux de dégivrage.
- Isolation à base de polyuréthane injecté, densité 40 kg / m³, faible GWP et aucun effet ODP.
- Le Contrôle digital de température ainsi que le dégivrage automatique œuvre à une meilleure gestion de la consommation énergétique.
- Température ambiante de travail à 32°C



AR-55 Página 305
Armario SNACK 55
SNACK cabinet 55
Armoire SNACK 55



DAE-400 Página 323
Armario euro SNACK 400
Euro SNACK cabinet 400
Armoire euro SNACK 400



AR-75 Página 307
Armario SNACK 75
SNACK cabinet 75
Armoire SNACK 75



ARG-75 Página 325
Armario gastro 75
Gastro cabinet 75
Armoire gastro 75



AR/ARP-125 Página 309
Armario SNACK 125
SNACK cabinet 125
Armoire SNACK 125



AE/AEP-125 Página 329
Armario euro SNACK 125
Euro SNACK cabinet 125
Armoire euro SNACK 125



AR-140 Página 313
Armario SNACK 125
SNACK cabinet 125
Armoire SNACK 125



AG-125 Página 333
Armario gastro 125
Gastro cabinet 125
Armoire gastro 125



AR-210 Página 315
Armario SNACK 210
SNACK cabinet 210
Armoire SNACK 210



AG-140 Página 335
Armario gastro 140
Gastro cabinet 140
Armoire gastro 140



DHEGR 75/140-PF Página 317
Armario GN 2/1 Alta eficiencia
SNACK cabinet GN 2/1 High efficiency
Armoire GN 2/1 Haute efficacité



ARG-210 Página 339
Armario gastro 140
Gastro cabinet 140
Armoire gastro 140



AG-50 Página 319
Armario gastro 50
Gastro cabinet 50
Armoire gastro 50



DBY / DQN Página 341
Armario gastro 140
Gastro cabinet 140
Armoire gastro 140



AEP-55 Página 321
Armario euro SNACK 55
Euro SNACK cabinet 55
Armoire euro SNACK 55



ALIMENTACION Página 343
Alimentación
Feeding
Alimentation

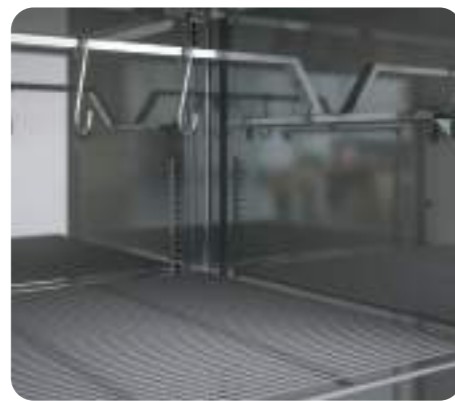

DETALLE EVAPORACION VENTILADA
 DETAIL VENTILATED EVAPORATION
 EVAPORATION VENTILE DETAIL



AR-55-2

RED FRESH OPCIONAL - OPTIONAL - EN OPTION



CARACTERÍSTICAS TÉCNICAS

- AR refrigeración
- ARC congelación
- AR-E puerta cristal refrigeración
- ARC-E puerta cristal congelación

TECHNICAL DATA

- AR cooling
- ARC freezing
- AR-E cooling double glazed doors
- ARC-E freezing double glazed doors

CARACTÉRISTIQUES TECHNIQUES

- AR refroidissement
- ARC congélation
- AR-E refroidissement double vitrage
- ARC-E congélation double vitrage

Ver características técnicas en página 290 / See technical data in page 290 / Voir caractéristiques techniques page 290

* Gas opcional / * Optional gas / * Gaz optionnel

Modelo Modèle	Largo Longueur mm	Alto Hauteur mm	Fondo Profondeur mm	Rango Range Gamme	Estantes Shelves Étagères	Pares de guías Sets of slides Kit de guides	Capacidad Capacity Exposition L	Voltaje Voltage Tension	Refrig. Coolant Frigorigène	Potencia Frig. Frig Power Puissance Frig. W	Consumo Nominal Nominal Consumption Consommation Nominale W	Rango Range Gamme	clase climate 2015/1094 EN16825
AR-55	530	2040	770	-2°C +8°C	3	3	409	230 V - 50 Hz	R-290	303	207	E	5 (40°C 40%)
ARC-55	530	2040	770	-20°C -15°C	3	3	409	230 V - 50 Hz	R-290	495	474	E	4 (30°C 55%)
AR-55-E	530	2040	770	-2°C +8°C	4	4	409	230 V - 50 Hz	R-290	303	213	-	4 (30°C 55%)
ARC-55-E	530	2040	770	-20°C -15°C	4	4	409	230 V - 50 Hz	R-290	495	485	-	4 (30°C 55%)

PVP de opcionales incluidos en equipo, no como repuesto / PVP of options included in the equipment, not as a spare part / PVP d'options incluses dans l'équipement, pas en tant que pièce de rechange

OPCIONES · OPTIONS · OPTIONS

Parrilla adicional 600 X 400	600 X 400 Extra shelf	Grille additionnelle 600 X 400	27 € x ud
Cerradura puerta inox	Solid door lock	Serrure à porte inox	24 € x ud
Cerradura puerta cristal	Glass door lock	Serrure à porte en verre	61 € x ud
Barras carniceras	Bars for meat set	Tube de boucher	134 € x set
Set 4 ruedas	4 Castors set	Jeu 4 roulettes	98 € x set
Registrador de alarmas HACCP	HACCP alarm recorder	Enregistreur d'alarme HACCP	consultar - consult - consulter
Tropicalizado 43°C	Tropicalized to 43°C	Tropicalisé 43°C	consultar - consult - consulter
Respaldo inox	Stainless steel rear side	Soutien en inox	consultar - consult - consulter
230V 60hz / 115v 60hz	230V 60hz / 115v 60hz	230V 60hz / 115v 60hz	consultar - consult - consulter

Características técnicas y constructivas sujetas a variación sin previo aviso. / We reserve the right to change specifications without prior notice. / Sujet technique et la conception de modifications sans préavis.

AR-55

AR-55-E

AR-55-1 2.251 €	AR-55-2 2.307 €	AR-55-E 2.541 €
ARC-55-1 3.023 €	ARC-55-2 3.046 €	ARC-55-E 3.175 €

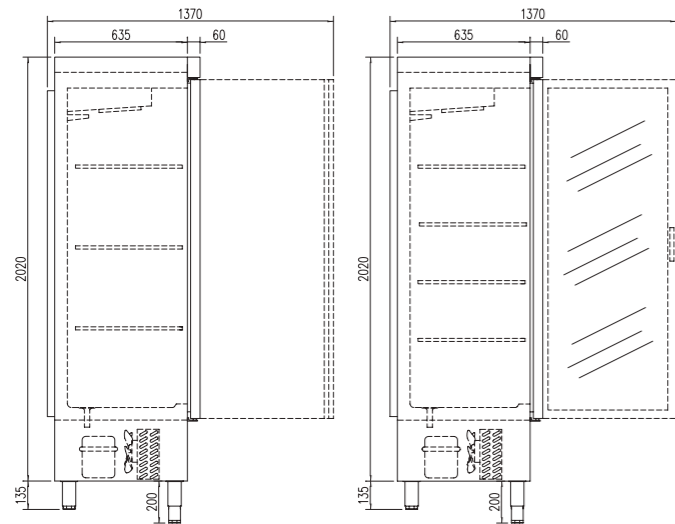

ARS / ACS

ARSV / ACSV



ARS-75-2



ACS-75-2



ARSV-75-1

CARACTERÍSTICAS TÉCNICAS	TECHNICAL DATA	CARACTÉRISTIQUES TECHNIQUES
<ul style="list-style-type: none"> ARS refrigeración ACS congelación ARSV refrigeración puerta cristal ACSV congelación puerta cristal 	<ul style="list-style-type: none"> ARS cooling ACS freezing ARSV cooling double glazed doors ACSV freezing double glazed doors 	<ul style="list-style-type: none"> ARG refroidissement ACS congélation ARGV refroidissement double vitrage ACSV congélation double vitrage

Ver características técnicas en página 290 / See technical data in page 290 / Voir caractéristiques techniques page 290

* Gas opcional / * Optional gas / * Gaz optionnel

Modelo Model Modèle	Largo Length Longueur mm	Alto Height Hauteur mm	Fondo Depth Profondeur mm	Rango Range Gamme	Estantes Shelves Étagères	Capacidad Capacity Exposition L	Voltaje Voltage Tension	Refrig. Coolant Frigorigène	Potencia Frig. Frig Power Puissance Frig. W	Consumo Nominal Nominal Consumption Consommation Nominale W	Rango Range Gamme	clase climate 2015/1094 EN16825
ARS-75	680	2160	735	-2°C +8°C	3	505	230 V - 50 Hz	R-290	502	232	C	5 (40°C 40%)
ACS-75	680	2160	735	-20°C -15°C	3	505	230 V - 50 Hz	R-290	606	553	E	4 (30°C 55%)
ARSV-75	680	2160	735	-2°C +8°C	4	505	230 V - 50 Hz	R-290	502	260	-	5 (40°C 40%)
ACSV-75	680	2160	735	-20°C -15°C	4	505	230 V - 50 Hz	R-290	606	560	-	4 (30°C 55%)

PVP de opcionales incluidos en equipo, no como repuesto / PVP of options included in the equipment, not as a spare part / PVP d'options incluses dans l'équipement, pas en tant que pièce de rechange

OPCIONES - OPTIONS - OPTIONS			
Parrilla adicional 560 X 542	560 X 542 Extra shelf	Grille additionnelle 560 X 542	28 € x ud
Cerradura puerta inox	Solid door lock	Serrure à porte inox	25 € x ud
Barras carniceras	Bars for meat set	Tube de boucher	135 € x set
Set adicional guías	Slides extra set	Kit supplémentaire de guides	24 € x ud
Cerradura puerta cristal	Glass door lock	Serrure à porte en verre	61 € x ud
Set 4 ruedas	4 Castors set	Jeu 4 roulettes	98 € x set
Registrador de alarmas HACCP	HACCP alarm recorder	Enregistreur d'alarme HACCP	consultar - consult - consulter
Tropicalizado 43°C	Tropicalized to 43°C	Tropicalisé 43°C	consultar - consult - consulter
Respaldo inox	Stainless steel rear side	Soutien en inox	consultar - consult - consulter
230V 60hz / 115v 60hz	230V 60hz / 115v 60hz	230V 60hz / 115v 60hz	consultar - consult - consulter

Características técnicas y constructivas sujetas a variación sin previo aviso. / We reserve the right to change specifications without prior notice. / Sujet technique et la conception de modifications sans préavis.

	ARS-75-1	2.439 €		ARS-75-2	2.499 €		ARSV-75-1	2.935 €
	ACS-75-1	3.414 €		ACS-75-2	3.472 €		ACSV-75-1	3.930 €



AR-125



DETALLE EVAPORACION VENTILADA
DETAIL VENTILATED EVAPORATION
EVAPORATION VENTILE DETAIL



OPCIONAL LACADO NEGRO
BLACK LACQUER OPTION
LAQUE NOIRE EN OPTION



RED FRESH OPCIONAL - OPTIONAL - EN OPTION



AR-125-2



LED

AR-125-2-E

CARACTERÍSTICAS TÉCNICAS	TECHNICAL DATA	CARACTÉRISTIQUES TECHNIQUES
<ul style="list-style-type: none"> AR refrigeración ARC congelación AR-E puerta cristal refrigeración ARC-E puerta cristal congelación ARM Departamento congelados 	<ul style="list-style-type: none"> AR cooling ARC freezing AR-E cooling double glazed doors ARC-E freezing double glazed doors ARM frozen department 	<ul style="list-style-type: none"> AR refroidissement ARC congélation AR-E refroidissement double vitrage ARC-E congélation double vitrage ARM département gelé

Ver características técnicas en página 290 / See technical data in page 290 / Voir caractéristiques techniques page 290

* Gas opcional / * Optional gas / * Gaz optionnel

Modelo Modèle	Largo Longueur mm	Alto Height mm	Fondo Depth Profondeur mm	Rango Range Gamme	Estantes Shelves Étagères	Pares de guías Sets of slides Kit de guides	Capacidad Capacity Exposition L	Voltaje Voltage Tension	Refrig. Coolant Frigorigène	Potencia Frig. Frig Power Puissance Frig. W	Consumo Nominal Nominal Consumption Consommation Nominale W	Rango Range Gamme	clase climate 2015/1094 EN16825 Rango Range Gamme
AR-125-2	1250	2040	700	-2°C +8°C	6	6	964	230 V - 50 Hz	R-290	543	416	D	5 (40°C 40%)
ARC-125-2	1250	2040	700	-20°C -15°C	6	6	964	230 V - 50 Hz	R-290	833	810	E	4 (30°C 55%)
AR-125-E-2	1250	2040	700	-2°C +8°C	8	8	964	230 V - 50 Hz	R-290	543	434	-	4 (30°C 55%)
ARC-125-E-2	1250	2040	700	-20°C -15°C	8	8	964	230 V - 50 Hz	R-290	833	828	-	4 (30°C 55%)
ARM-125-2	1250	2040	700	-20°C -15°C	6	6	830	230 V - 50 Hz	R-290 +R-290	271 + 385	213 + 432	-	4 (30°C 55%)

PVP de opcionales incluidos en equipo, no como repuesto / PVP of options included in the equipment, not as a spare part / PVP d'options incluses dans l'équipement, pas en tant que pièce de rechange

OPCIONES - OPTIONS - OPTIONS			
Parrilla adicional	Extra shelf	Grille additionnelle	46 € x ud
Set adicional guías	Slides extra set	Kit supplémentaire de guides	29 € x set
Cerradura puerta inox	Solid door lock	Serrure à porte inox	24 € x ud
Cerradura puerta cristal	Glass door lock	Serrure à porte en verre	61 € x ud
Barras carniceras	Bars for meat set	Tube de boucher	134 € x set
Set 6 ruedas	6 Castors set	Jeu 6 roulettes	146 € x set
Registrador de alarmas HACCP	HACCP alarm recorder	Enregistreur d'alarme HACCP	consultar - consult - consulter
Tropicalizado 43°C	Tropicalized to 43°C	Tropicalisé 43°C	consultar - consult - consulter
Respaldo inox	Stainless steel rear side	Soutien en inox	consultar - consult - consulter
230V 60hz / 115v 60hz	230V 60hz / 115v 60hz	230V 60hz / 115v 60hz	consultar - consult - consulter

Características técnicas y constructivas sujetas a variación sin previo aviso. / We reserve the right to change specifications without prior notice. / Sujet technique et la conception de modifications sans préavis.

AR-125-2 3.077 €	AR-125-2-E 3.676 €	AR-125-3 3.128 €	AR-125-4 3.170 €	ARM-125-2 5.144 €
ARC-125-2 4.137 €	ARC-125-2-E 4.871 €	ARC-125-3 4.195 €	ARC-125-4 4.239 €	

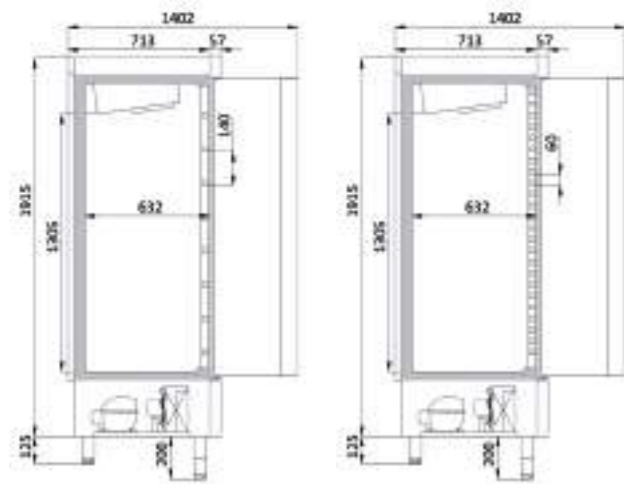

ARP-125-14

ARP-125-40



DETALLE CAJONES DE PESCADO
DETAIL OF FISH DRAWERS
DÉTAIL DES TIROIRS À POISSON



ARP-125-40



ARP-125-E-40

CARACTERÍSTICAS TÉCNICAS

- ARP-125-14: Refrigeración pescado
- ARP-125-40 Refrigeración pastelería
- ARPC-125-40 Mantenimiento congelados pastelería
- ARP-E Puerta cristal refrigeración
- ARPC-E Puerta cristal congelación

TECHNICAL DATA

- ARP-125-14: Fish refrigeration
- ARP-125-40 Pastry refrigeration
- ARPC-125-40 Frozen pastry maintenance
- ARP-E Refrigeration glass door
- ARPC-E Freezing glass door

CARACTÉRISTIQUES TECHNIQUES

- ARP-125-14 : Réfrigération du poisson
- ARP-125-40 Réfrigération de pâtisserie
- ARPC-125-40 Entretien pâtisserie surgelée
- ARP-E Porte vitrée de réfrigération
- ARPC-E Porte vitrée de congélation

Ver características técnicas en página 290 / See technical data in page 290 / Voir caractéristiques techniques page 290

* Gas opcional / * Optional gas / * Gaz optionnel

Modelo Model Modèle	Largo Length Longueur mm	Alto Height Hauteur mm	Fondo Depth Profondeur mm	Rango Range Gamme	Estantes Shelves Étagères	Cajones Drawers Tiroirs	Pares de guías Sets of slides Kit de guides	Capacidad Capacity Exposition L	Voltaje Voltage Tension	Refrig. Coolant Frigorigène	Potencia Frig. Frig Power Puissance Frig. W	Consumo Nominal Nominal Consumption Consommation Nominale W	Rango Range Gamme
ARP-125-14	1250	2040	770	-5° -1°C	0	14	14	979	230 V - 50 Hz	R-290	833	810	5 (40°C 40%)
ARP-125-40	1250	2040	770	0° + 8°C	6	0	34	979	230 V - 50 Hz	R-290	543	434	5 (40°C 40%)
ARPC-125-40	1250	2040	770	-20° -15°C	6	0	34	979	230 V - 50 Hz	R-290	833	810	4 (30°C 55%)
ARP-125-E-40	1250	2040	770	0° + 8°C	6	0	34	979	230 V - 50 Hz	R-290	543	434	4 (30°C 55%)
ARPC-125-E-40	1250	2040	770	-20° -15°C	6	0	34	979	230 V - 50 Hz	R-290	833	824	4 (30°C 55%)

PVP de opcionales incluidos en equipo, no como repuesto / PVP of options included in the equipment, not as a spare part / PVP d'options incluses dans l'équipement, pas en tant que pièce de rechange

OPCIONES - OPTIONS - OPTIONS

Parrilla adicional 600 X 400	600 X 400 Extra shelf	Grille additionnelle 600 X 400	46 € x ud
Set adicional guías	Slides extra set	Kit supplémentaire de guides	29 € x set
Cerradura puerta inox	Solid door lock	Serrure à porte inox	24 € x ud
Cerradura puerta cristal	Glass door lock	Serrure à porte en verre	61 € x ud
Barras carniceras	Bars for meat set	Tube de boucher	134 € x set
Set 6 ruedas	6 Castors set	Jeu 6 roulettes	146 € x set
Registrador de alarmas HACCP	HACCP alarm recorder	Enregistreur d'alarme HACCP	consultar - consult - consulter
Tropicalizado 43°C	Tropicalized to 43°C	Tropicalisé 43°C	consultar - consult - consulter
Respaldo inox	Stainless steel rear side	Soutien en inox	consultar - consult - consulter
230V 60hz / 115v 60hz	230V 60hz / 115v 60hz	230V 60hz / 115v 60hz	consultar - consult - consulter

Características técnicas y constructivas sujetas a variación sin previo aviso. / We reserve the right to change specifications without prior notice. / Sujet technique et la conception de modifications sans préavis.

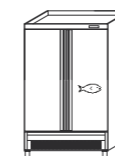

ARP-125-14 3.859 €

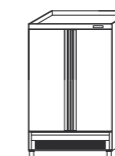

ARP-125-40 3.605 €
ARP-125-40-E 3.751 €

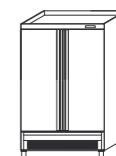

ARPC-125-40 4.670 €
ARPC-125-40-E 5.150 €

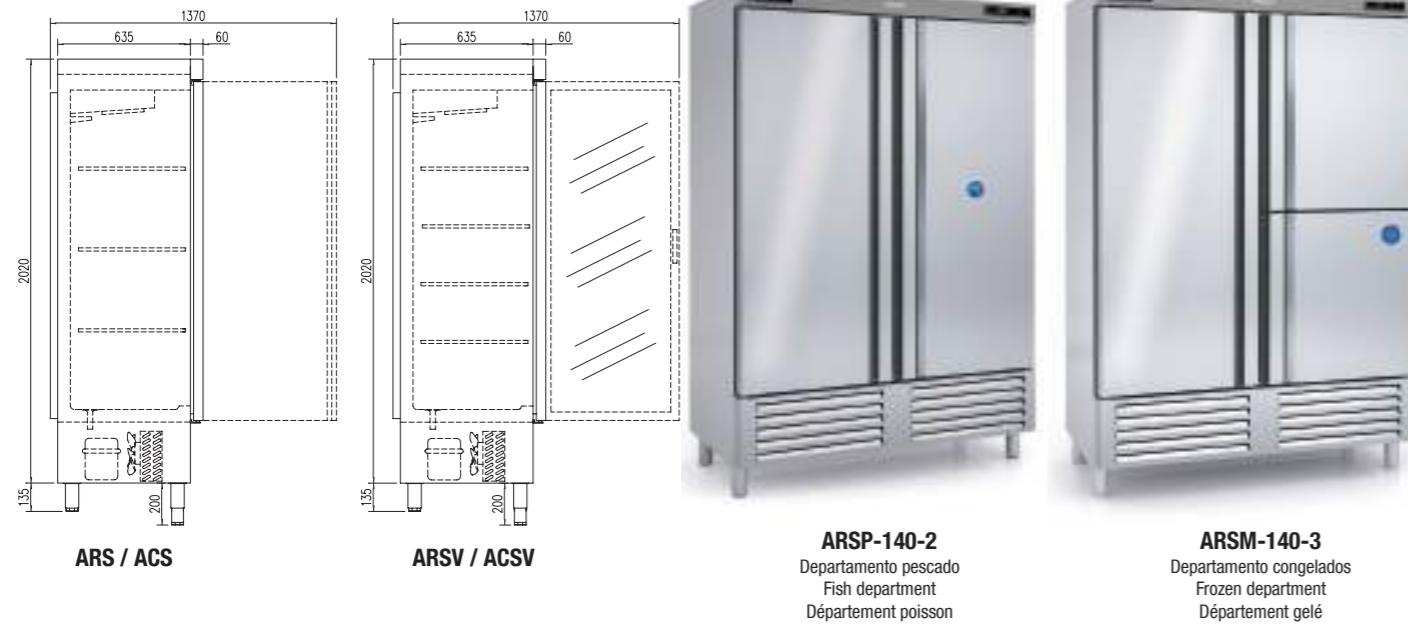

LED

ACS-140-4

ARSV-140-2

CARACTERÍSTICAS TÉCNICAS	TECHNICAL DATA	CARACTÉRISTIQUES TECHNIQUES
<ul style="list-style-type: none"> ARS refrigeración ACS congelación ARSV puerta cristal refrigeración ACSV puerta cristal congelación ARSP departamento pescado ARSM departamento congelados 	<ul style="list-style-type: none"> ARS cooling ACS freezing ARSV cooling double glazed doors ACSV freezing double glazed doors ARSP fish department ARSM frozen department 	<ul style="list-style-type: none"> ARS refroidissement ACS congélation ARSV refroidissement double vitrage ACSV congélation double vitrage ARSP département de poisson ARSM département gelé

Ver características técnicas en página 290 / See technical data in page 290 / Voir caractéristiques techniques page 290

* Gas opcional / * Optional gas / * Gaz optionnel

Modelo	Largo	Alto	Fondo	Rango	Estantes	Cajones	Pares de guías	Capacidad	Voltaje	Refrig.	Potencia Frig.	Consumo Nominal	Rango	clase climate
Model	Length	Height	Depth	Range	Shelves	Drawers	Sets of slides	Capacity	Voltage	Coolant	Frig Power	Nominal Consumption	Range	2015/1094 EN16825
Modèle	Longueur	Hauteur	Profondeur	Gamme	Étagères	Tiroirs	Kit de guides	Exposition	Tension	Frigorigène	Puissance Frig.	Consommation Nominale	Gamme	EN16825
ARS-140	1370	2160	730	-2°C / +8°C	6 + 3	0	0	1201	230 V - 50 Hz	R-290	845	373	D	5 (40°C 40%)
ACS-140	1370	2160	730	-20°C / -15°C	6 + 3	0	0	1201	230 V - 50 Hz	R-290	907	952	E	4 (30°C 55%)
ARSV-140	1370	2160	730	-2°C / +8°C	8 + 4	0	0	1201	230 V - 50 Hz	R-290	845	396	-	4 (30°C 55%)
ACSV-140	1370	2160	730	-20°C / -15°C	8 + 4	0	0	1201	230 V - 50 Hz	R-290	907	957	-	4 (30°C 55%)
ARSP-140-2	1390	2115	730	-2°C / -5°C / +8°C / -1°C	3	6	6	1010	230 V - 50 Hz	R-290 +R-290	502 + 245	253 + 431	-	
ARSP-140-3	1390	2115	730	-2°C / -5°C / +8°C / -1°C	4 + 1	3	3	1165	230 V - 50 Hz	R-290 +R-290	845 + 502	372 + 369	-	
ARSM-140-2	1390	2115	730	-2°C / -20°C / +8°C / -15°C	5 + 1	0	0	1010	230 V - 50 Hz	R-290 +R-290	820 + 398	523 + 445	-	
ARSM-140-3	1390	2115	730	-2°C / -20°C / +8°C / -15°C	4 + 1	0	0	1165	230 V - 50 Hz	R-290 +R-290	845 + 606	361 + 553	-	

PVP de opcionales incluidos en equipo, no como repuesto / PVP of options included in the equipment, not as a spare part / PVP d'options incluses dans l'équipement, pas en tant que pièce de rechange

OPCIONES · OPTIONS · OPTIONS			
Parrilla adicional 560 X 542	560 X 542 Extra shelf	Grille additionnelle 560 X 542	35 € x ud
Parrilla intermedia adicional 450 X 158	450 X 158 Extra middle shelf	Kit supplémentaire de guides 450 X 158	20 € x ud
Cerradura puerta inox	Solid door lock	Serrure à porte inox	25 € x ud
Cerradura puerta cristal	Glass door lock	Serrure à porte de verre	61 € x ud
Barras carniceras	Bars for meat set	Tube de boucher	135 € x set
Set 6 ruedas	6 Castors set	Jeu 6 roulettes	146 € x set
Set adicional guías	Slides extra set	Kit supplémentaire de guides	24 € x set
Registrador de alarmas HACCP	HACCP alarm recorder	Enregistreur d'alarme HACCP	consultar - consult - consulter
Respaldo inox	Stainless steel rear side	Soutien en inox	consultar - consult - consulter
Tropicalizado 43°C	Tropicalized to 43°C	Tropicalisé 43°C	consultar - consult - consulter
230V 60hz / 115v 60hz	230V 60hz / 115v 60hz	230V 60hz / 115v 60hz	consultar - consult - consulter

Características técnicas y constructivas sujetas a variación sin previo aviso. / We reserve the right to change specifications without prior notice. / Sujet technique et la conception de modifications sans préavis.

ARS-140-2 3.323 €	ARS-140-3 3.398 €	ARS-140-4 3.425 €	ARSV-140-2 4.362 €
ACS-140-2 4.451 €	ACS-140-3 4.518 €	ACS-140-4 4.585 €	ACSV-140-2 5.742 €
ARSP-140-2 4.553 €	ARSP-140-3 4.317 €	ARSM-140-2 5.389 €	ARSM-140-3 4.605 €

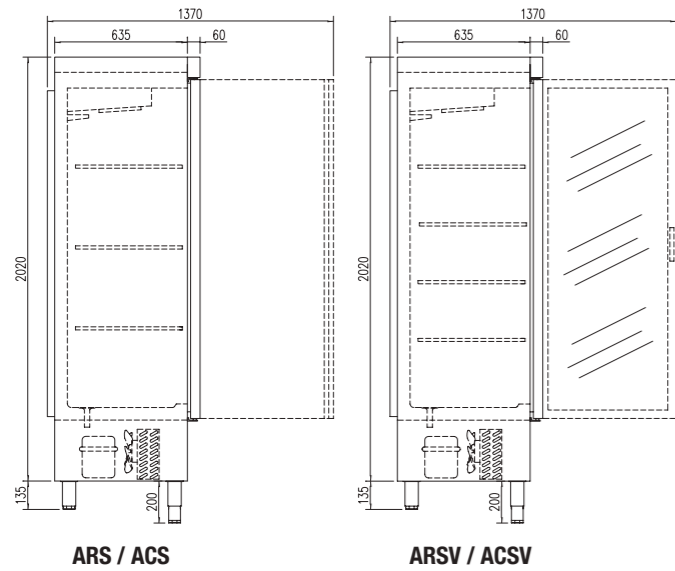

CARACTERÍSTICAS TÉCNICAS	TECHNICAL DATA	CARACTÉRISTIQUES TECHNIQUES
<ul style="list-style-type: none"> ARS refrigeración ACS congelación ARSV puerta cristal refrigeración ACSV puerta cristal congelación ARSP departamento pescado ARSM departamento congelados 	<ul style="list-style-type: none"> ARS cooling ACS freezing ARSV cooling double glazed doors ACSV freezing double glazed doors ARSP fish department ARSM frozen department 	<ul style="list-style-type: none"> ARS refroidissement ACS congélation ARSV refroidissement double vitrage ACSV congélation double vitrage ARSP département de poisson ARSM département gelé

Ver características técnicas en página 290 / See technical data in page 290 / Voir caractéristiques techniques page 290

* Gas opcional / * Optional gas / * Gaz optionnel

Modelo	Largo	Alto	Fondo	Rango	Estantes	Cajones	Pares de guías	Capacidad	Voltaje	Refrig.	Potencia Frig.	Consumo Nominal	Rango	clase climate
Model	Length	Height	Depth	Range	Shelves	Drawers	Sets of slides	Capacity	Voltage	Coolant	Frig Power	Nominal Consumption	Range	2015/1094 EN16825
Modèle	Longueur	Hauteur	Profondeur	Gamme	Étagères	Tiroirs	Kit de guides	Exposition	Tension	Frigorigène	Puissance Frig.	Consommation Nominale	Gamme	EN16825
ARS-210	2055	2160	735	-2°C +8°C	9 + 6	0	0	1852	230 V - 50 Hz	R-290	1702	897	E	5 (40°C 40%)
ACS-210	2055	2160	735	-20°C -15°C	9 + 6	0	0	1852	230 V - 50 Hz	R-290	1814	1680	E	4 (30°C 55%)
ARSV-210	2055	2160	735	-2°C +8°C	12 + 8	0	0	1852	230 V - 50 Hz	R-290	1702	943	-	4 (30°C 55%)
ACSV-210	2055	2160	735	-20°C -15°C	12 + 8	0	0	1852	230 V - 50 Hz	R-290	1814	1726	-	4 (30°C 55%)
ARSP-210	2055	2160	735	-2°C / -5°C +8°C / -1°C	6 + 3	6	6	1725	230 V - 50 Hz	R-290 +R-290	845 + 845	370 + 431	-	-
ARSM-210	2055	2115	735	-2°C / -20°C +8°C / -15°C	9 + 3	0	0	1725	230 V - 50 Hz	R-290 +R-290	845 + 361	370 + 642	-	-

PVP de opcionales incluidos en equipo, no como repuesto / PVP of options included in the equipment, not as a spare part / PVP d'options incluses dans l'équipement, pas en tant que pièce de rechange

OPCIONES - OPTIONS - OPTIONS			
Parrilla adicional 560 X 542	560 X 542 Extra shelf	Grille additionnelle 560 X 542	35 € x ud
Parrilla intermedia adicional 450 X 158	450 X 158 Extra middle shelf	Kit supplémentaire de guides 450 X 158	20 € x ud
Cerradura puerta inox	Solid door lock	Serrure à porte inox	25 € x ud
Cerradura puerta cristal	Glass door lock	Serrure à porte de verre	61 € x ud
Barras carniceras	Bars for meat set	Tube de boucher	135 € x set
Set 6 ruedas	6 Castors set	Jeu 6 roulettes	146 € x set
Set adicional guías	Slides extra set	Kit supplémentaire de guides	24 € x set
Registrador de alarmas HACCP	HACCP alarm recorder	Enregistreur d'alarme HACCP	consultar - consult - consulter
Respaldo inox	Stainless steel rear side	Soutien en inox	consultar - consult - consulter
Tropicalizado 43°C	Tropicalized to 43°C	Tropicalisé 43°C	consultar - consult - consulter
230V 60hz / 115v 60hz	230V 60hz / 115v 60hz	230V 60hz / 115v 60hz	consultar - consult - consulter

Características técnicas y constructivas sujetas a variación sin previo aviso. / We reserve the right to change specifications without prior notice. / Sujet technique et la conception de modifications sans préavis.

 ARS-210-3 4.813 € ACS-210-3 6.042 €	 ARS-210-4 4.867 € ACS-210-4 6.087 €	 ARS-210-5 4.922 € ACS-210-5 6.156 €	 ARS-210-6 4.975 € ACS-210-6 6.214 €
 ARSV-210-3 6.068 € ACSV-210-3 7.118 €	 ARSP-210-5 5.812 €	 ARSM-210-5 5.906 €	

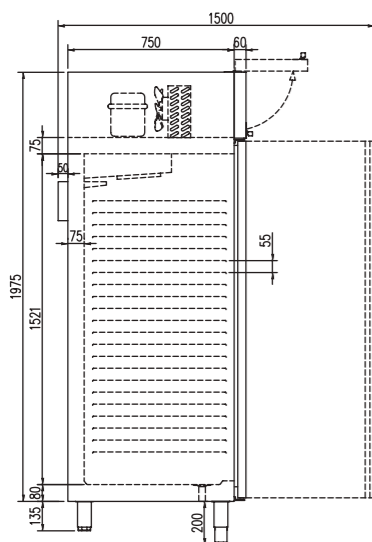

AISLAMIENTO 40Kg/cm3
 40Kg/cm3 INSULATION
 40Kg/cm3 ISOLEMENT



DETALLE CONTRAPUERTA EMBUTIDA
 DETAIL INLET BACK DOOR
 DÉTAIL DE LA PORTE ARRIÈRE

CARACTERÍSTICAS TÉCNICAS

- Aislamiento de poliuretano inyectado y grosor 85mm , densidad 40kg/m3, cero GWP y cero ODP
- Ventiladores alta eficiencia
- Control digital de temperatura, descargas optimizados, alarma por puerta abierta y alta temperatura de condensación. Eficiente gestión del consumo de energía
- DHEGR refrigeración
- DHECG congelación

TECHNICAL DATA

- Injected polyurethane insulation and thickness 85mm perimeter, density 40kg / m3, zero GWP and zero ODP
- High efficiency fans
- Digital temperature control, optimized defrosting, open door alarm and high condensing temperature. Efficient management of energy consumption
- DHEGR refrigeration
- DHECG freezing

CARACTÉRISTIQUES TECHNIQUES

- Isolation en polyuréthane injecté et périmètre de 85mm d'épaisseur, densité 40kg / m3, zéro GWP et zéro ODP
- Ventilateurs à haut rendement
- Contrôle numérique de la température, dégivrage optimisé, alarme de porte ouverte et température de condensation élevée. Gestion efficace de la consommation d'énergie
- DHEGR Réfrigération
- DHECG congélation

Ver características técnicas en página 290 / See technical data in page 290 / Voir caractéristiques techniques page 290



DHEGR-75-1



DHEGR-140-2

Modelo Model	Largo Length Longueur mm	Alto Height Hauteur mm	Fondo Depth Profondeur mm	Rango Range Gamme	Estantes Shelves Étagères GN 2/1	Nivel de estantes Level shelves Niveau étagères	Capacidad Capacity Exposition L	Voltaje Voltage Tension	Refrig. Coolant Frigorigène	Potencia Frig. Frig Power Puissance Frig. W	Consumo Nominal Nominal Consumption Consommation Nominale W	CCE EEC 2015/1094 EN16825	clase climate 2015/1094 EN16825
DHEGR-75-PF85	705	2175	885	-2°C +8°C	3	24	645	230 V - 50 Hz	R-290	502	182	A	5 (40°C 40%)
DHEGC-75-PF85	705	2175	885	-20°C -15°C	3	24	645	230 V - 50 Hz	R-290	495	369	C	5 (40°C 40%)
DHEGR-140-PF85	1395	2175	885	-2°C +8°C	6	24	1404	230 V - 50 Hz	R-290	845	303	B	5 (40°C 40%)
DHEGC-140-PF85	1395	2175	885	-20°C -15°C	6	24	1404	230 V - 50 Hz	R-290	907	839	D	4 (30°C 55%)

PVP de opcionales incluidos en equipo, no como repuesto / PVP of options included in the equipment, not as a spare part / PVP d'options incluses dans l'équipement, pas en tant que pièce de rechange

OPCIONES - OPTIONS - OPTIONS

Parrilla adicional 650X530 GN2/1	650X530 GN2/1 Extra shelf	Grille additionnelle 650X530 GN2/1	55 € x ud
Barras carniceras	Bars for meat set	Tube de boucher	135 € x set
Set 4 ruedas	4 Castors set	Jeu 4 roulettes	98 € x set
Registrador de alarmas HACCP	HACCP alarm recorder	Enregistreur d'alarme HACCP	consultar
Respaldo inox	Stainless steel rear side	Soutien en inox	consultar

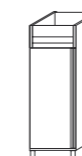

DHEGR-75-1-PF85 3.520 €
 DHEGC-75-1-PF85 3.899 €

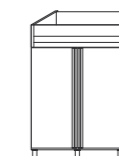

DHEGR-140-2-PF85 5.935 €
 DHEGC-140-2-PF85 7.607 €

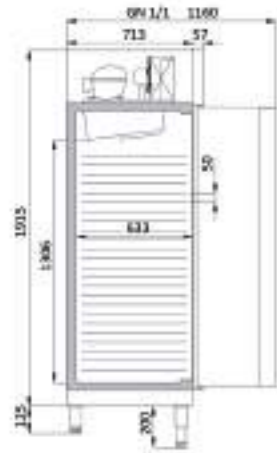

CARACTERÍSTICAS TÉCNICAS	TECHNICAL DATA	CARACTÉRISTIQUES TECHNIQUES
<ul style="list-style-type: none"> AG refrigeración AGC congelación AG-E puerta cristal refrigeración AGC-E puerta cristal congelación 	<ul style="list-style-type: none"> AG cooling AGC freezing AG-E cooling double glazed doors AGC-E freezing double glazed doors 	<ul style="list-style-type: none"> AG refroidissement AGC congélation AG-E refroidissement double vitrage AGC-E congélation double vitrage

Ver características técnicas en página 290 / See technical data in page 290 / Voir caractéristiques techniques page 290

* Gas opcional / * Optional gas / * Gaz optionnel

Modelo Modèle	Largo Longueur mm	Alto Height mm	Fondo Depth Profondeur mm	Rango Range Gamme	Estantes Shelves Étagères	Nivel de estantes Level shelves Niveau étagères	Capacidad Capacity Exposition L	Voltaje Voltage Tension	Refrig. Coolant Frigorigène	Potencia Frig. Frig Power Puissance Frig. W	Consumo Nominal Nominal Consumption Consommation Nominale W	Rango Range Gamme	clase climate 2015/1094 EN16825	Rango Range Gamme
AG-50	430	2040	770	-2°C +8°C	3	24	301	230 V - 50 Hz	R-290	271	201	E	5 (40°C 40%)	
AGC-50	430	2040	770	-20°C -15°C	3	24	301	230 V - 50 Hz	R-290	385	432	E	4 (30°C 55%)	
AG-E-50	430	2040	770	-2°C +8°C	4	24	301	230 V - 50 Hz	R-290	271	213	-	4 (30°C 55%)	
AGC-E-50	430	2040	770	-20°C -15°C	4	24	301	230 V - 50 Hz	R-290	385	445	-	4 (30°C 55%)	



AG-50-1



AG-50-E

PVP de opcionales incluidos en equipo, no como repuesto / PVP of options included in the equipment, not as a spare part / PVP d'options incluses dans l'équipement, pas en tant que pièce de rechange

OPCIONES - OPTIONS - OPTIONS			
Parrilla adicional 530 X 325 GN1/1	530 X 325 GN1/1 extra shelf	Grille additionnelle 530 X 325 GN1/1	28 € x ud
Set 4 ruedas	4 Castors set	Jeu 4 roulettes	98 € x set
Registrador de alarmas HACCP	HACCP alarm recorder	Enregistreur d'alarme HACCP	consultar - consult - consulter
Tropicalizado 43°C	Tropicalized to 43°C	Tropicalisé 43°C	consultar - consult - consulter
Respaldo inox	Stainless steel rear side	Soutien en inox	consultar - consult - consulter
230V 60hz / 115v 60hz	230V 60hz / 115v 60hz	230V 60hz / 115v 60hz	consultar - consult - consulter

Características técnicas y constructivas sujetas a variación sin previo aviso. / We reserve the right to change specifications without prior notice. / Sujet technique et la conception de modifications sans préavis.

	AG-50-1	2.183 €		AG-50-E	2.459 €
	AGC-50-1	2.833 €		AGC-50-E	3.175 €

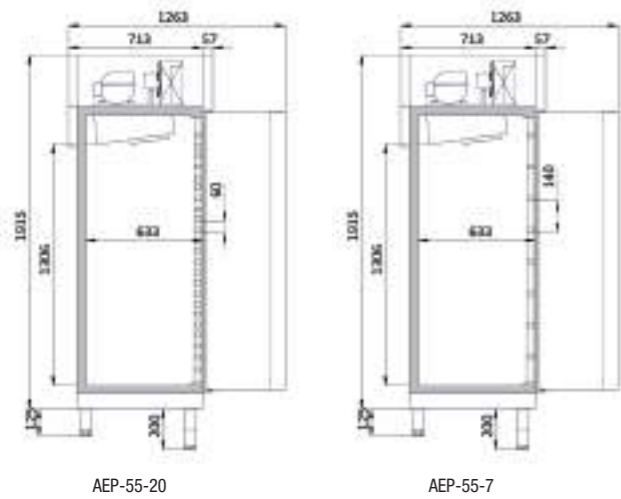

CARACTERÍSTICAS TÉCNICAS	TECHNICAL DATA	CARACTÉRISTIQUES TECHNIQUES
<ul style="list-style-type: none"> AEP refrigeracion AEPC congelacion AEP-E refrigeracion puerta cristal AEP-55-7 pescado 	<ul style="list-style-type: none"> AEP cooling AEPC freezing AEP-E cooling double glazed doors AEP-55-7 poisson 	<ul style="list-style-type: none"> AEP refroidissement AEPG congélation AEP-E refroidissement double vitrage AEP-55-7 poisson

Ver características técnicas en página 290 / See technical data in page 290 / Voir caractéristiques techniques page 290
* Gas opcional / * Optional gas / * Gaz optionnel

Modelo	Largo	Alto	Fondo	Rango	Estantes	Cajas pescado	Pares de guías	Capacidad	Voltaje	Refrig.	Potencia Frig.	Consumo Nominal	Rango	clase climate
Model	Length	Height	Depth	Range	Shelves	Fish boxes	Sets of slides	Capacity	Voltage	Coolant	Frig Power	Nominal Consumption	Range	2015/1094 EN16825
Modèle	Longueur	Hauteur	Profondeur	Gamme	Étagères	Boîtes poissons	Kit de guides	Exposition	Tension	Frigorigène	Puissance Frig.	Consommation Nominale	Gamme	EN16825
	mm	mm	mm					L			W	W		Range
AEP-55-7	530	2040	770	-5°C -1°C	0	7	7	409	230 V - 50 Hz	R-290	303	201	-	5 (40°C 40%)
AEP-55-20	530	2040	770	0°C +8°C	3	0	17	409	230 V - 50 Hz	R-290	303	201	E	5 (40°C 40%)
AEP-55-E-20	530	2040	770	0°C +8°C	3	0	17	409	230 V - 50 Hz	R-290	303	213	-	4 (30°C 55%)
AEPC-55-20	530	2040	770	-20°C -15°C	3	0	17	409	230 V - 50 Hz	R-290	495	474	E	4 (30°C 55%)
AEPC-55-E-20	530	2040	770	-20°C -15°C	3	0	17	409	230 V - 50 Hz	R-290	495	485	-	4 (30°C 55%)

AEP-55-20
PASTELERÍA
PASTRY
PÂTISSERIE

AEP-55-7
Pescado
Fish
Poisson

PVP de opcionales incluidos en equipo, no como repuesto / PVP of options included in the equipment, not as a spare part / PVP d'options incluses dans l'équipement, pas en tant que pièce de rechange

OPCIONES - OPTIONS - OPTIONS			
Parrilla 600 x 400	600 x 400 shelf	Grille 600 x 400	27 € x ud
Set adicional guías AP	AP slides extra set	Kit supplémentaire de guides AP	29 € x set
Cerradura puerta inox	Solid door lock	Serrure à porte inox	24 € x ud
Cerradura puerta cristal	Glass door lock	Serrure à porte en verre	61 € x ud
Set 4 ruedas	4 Castors set	Jeu 4 roulettes	98 € x set
Registrador de alarmas haccp	Haccp alarm recorder	Enregistreur d'alarme HACCP	consultar - consult - consulter
Tropicalizado 43°C	Tropicalized to 43°C	Tropicalisé 43°C	consultar - consult - consulter
Respaldo inox	Stainless steel rear side	Soutien en inox	consultar - consult - consulter
230V 60hz / 115v 60hz	230V 60hz / 115v 60hz	230V 60hz / 115v 60hz	consultar - consult - consulter

Características técnicas y constructivas sujetas a variación sin previo aviso. / We reserve the right to change specifications without prior notice. / Sujet technique et la conception de modifications sans préavis.

AEP-55-7 2.945 €	AEP-55-20 2.811 € AEPC-55-20 3.266 €	AEP-55-E-20 2.861 € AEPC-55-E-20 3.518 €

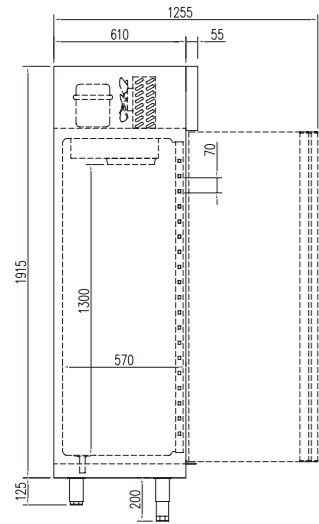

CARACTERÍSTICAS TÉCNICAS	TECHNICAL DATA	CARACTÉRISTIQUES TECHNIQUES
<ul style="list-style-type: none"> • AE refrigeración • AEC congelación • AE-E refrigeración puerta cristal • AEC-E congelación puerta cristal 	<ul style="list-style-type: none"> • AE cooling • AEC freezing • AE-E cooling double glazed doors • AEC-E freezing double glazed doors 	<ul style="list-style-type: none"> • AE refroidissement • AEC congélation • AE-E refroidissement double vitrage • AEC-E congélation double vitrage

Ver características técnicas en página 290 / See technical data in page 290 / Voir caractéristiques techniques page 290

* Gas opcional / * Optional gas / * Gaz optionnel

Modelo Modèle	Largo Longueur mm	Alto Height mm	Fondo Depth mm	Rango Range Gamme	Estantes Shelves Étagères	Cajones Drawers Tiroirs	Capacidad Capacity Exposition L	Tensión monofásica Single phase voltage Tension monophasique	Refrig. Coolant Frigorigène	Potencia Frig. Frig Power Puissance Frig. W	Consumo Consumption Consommation W	Rango Range Gamme	clase climate 2015/1094 EN16825
DAER-400	600	1900	650	-2°C +8°C	3	0	337	230 V - 50 Hz	R-290	502	243	D	5 40°C 40%
DAEC-400	600	1900	650	-20°C -15°C	3	0	337	230 V - 50 Hz	R-290	606	546	E	4 30°C 55%
DAP-400	600	1900	650	-5°C -1°C	5	5	337	230 V - 50 Hz	R-290	845	434	-	4 30°C 55%



DAER-401



DAERE-401

LED

PVP de opcionales incluidos en equipo, no como repuesto / PVP of options included in the equipment, not as a spare part / PVP d'options incluses dans l'équipement, pas en tant que pièce de rechange

OPCIONES - OPTIONS - OPTIONS			
Parrilla adicional	Extra shelf	Grille additionnelle	32 € x ud
Cerradura puerta inox	Solid door lock	Serrure à porte inox	25 € x ud
Cerradura puerta cristal	Glass door lock	Serrure à porte en verre	61 € x ud
Barras carniceras	Bars for meat set	Tube de boucher	135 € x set
Set 4 ruedas	4 Castors set	Jeu 4 roulettes	98 € x set
Registrador de alarmas HACCP	HACCP alarm recorder	Enregistreur d'alarme HACCP	consultar - consult - consulter
Tropicalizado 43°C	Tropicalized to 43°C	Tropicalisé 43°C	consultar - consult - consulter
Respaldo inox	Stainless steel rear side	Soutien en inox	consultar - consult - consulter
230V 60hz / 115v 60hz	230V 60hz / 115v 60hz	230V 60hz / 115v 60hz	consultar - consult - consulter

Características técnicas y constructivas sujetas a variación sin previo aviso. / We reserve the right to change specifications without prior notice. / Sujet technique et la conception de modifications sans préavis.

	DAER-401	2.252 €		DAP-400	2.818 €		DAERE-401	2.461 €
	DAER-402	2.326 €					DAECE-401	3.124 €
	DAEC-401	2.922 €						
	DAEC-402	2.989 €						

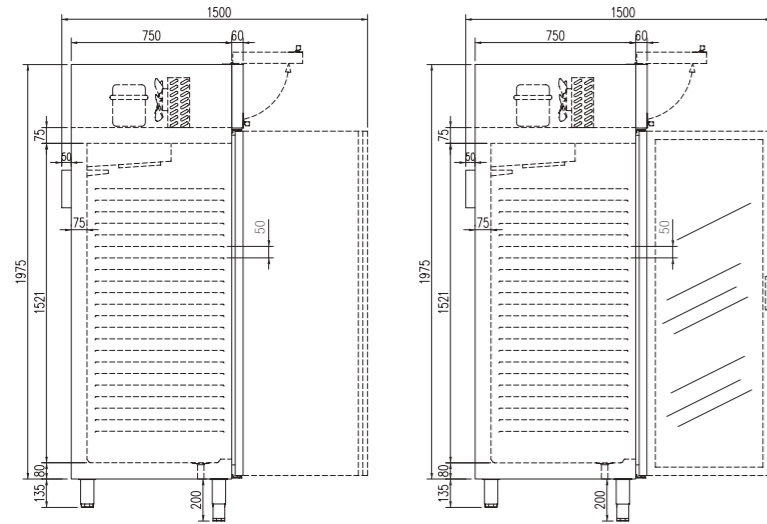

AGR / ACG

AGRE / ACGE

CARACTERÍSTICAS TÉCNICAS

- Aislamiento de poliuretano inyectado perimetral, densidad 40kg/m3, cero GWP y cero ODP
- Costados en acero inox AISI-304 con 22 embuticiones para apoyo de parrillas y cubetas GN 1/1 o GN 2/1
- Control digital de temperatura, descargas optimizados, alarma por puerta abierta y alta temperatura de condensación. Eficiente gestión del consumo de energía
- ARG refrigeración
- AG-C congelación
- AGRV puerta cristal refrigeración
- AGV-C puerta cristal congelación

TECHNICAL DATA

- Injected polyurethane insulation perimeter, density 40kg / m3, zero GWP and zero ODP
- Sides in stainless steel AISI-304 with 22 embossments to support shelves and trays GN 1/1 or GN 2/1
- Digital temperature control, optimized defrosting, open door alarm and high condensing temperature. Efficient management of energy consumption
- ARG refrigeration
- AG-C freezing
- AGRV door glass cooling
- AGV-C freezing glass door

CARACTÉRISTIQUES TECHNIQUES

- Isolation en polyuréthane injecté d'épaisseur, densité 40kg / m3, zéro GWP et zéro ODP
- Côtés en acier inoxydable AISI-304 avec 22 gaufrages pour soutenir les étagères et les plateaux GN 1/1 ou GN 2/1
- Contrôle numérique de la température, dégivrage optimisé, alarme de porte ouverte et température de condensation élevée. Gestion efficace de la consommation d'énergie
- ARG Réfrigération
- AG-C congélation
- AGRV refroidissement de vitre de porte
- AGV-C porte vitrée

Ver características técnicas en página 290 / See technical data in page 290 / Voir caractéristiques techniques page 290

* Gas opcional / * Optional gas / * Gaz optionnel

Modelo Model Modèle	Largo Length Longueur mm	Alto Height Hauteur mm	Fondo Depth Profondeur mm	Rango Range Gamme	Estantes Shelves Étagères GN 2/1	Capacidad Capacity Exposition L	Voltaje Voltage Tension	Refrig. Coolant Frigorigène	Potencia Frig. Frig Power Puissance Frig. W	Consumo Nominal Nominal Consumption Consommation Nominale W	Rango Range Gamme	clase climate 2015/1094 EN16825
ARG-75	680	2130	850	-2°C +8°C	3	645	230 V - 50 Hz	R-290	502	243	C	5 (40°C 40%)
AG-75-C	680	2130	850	-20°C -15°C	3	645	230 V - 50 Hz	R-290	606	553	D	4 (30°C 55%)
ARGV-75	680	2130	850	-2°C +8°C	4	645	230 V - 50 Hz	R-290	502	260	-	5 (40°C 40%)
AGV-75-C	680	2130	850	-20°C -15°C	4	645	230 V - 50 Hz	R-290	606	560	-	4 (30°C 55%)



ARG-75-1-PF



ARGV-75-1-PF

PVP de opcionales incluidos en equipo, no como repuesto / PVP of options included in the equipment, not as a spare part / PVP d'options incluses dans l'équipement, pas en tant que pièce de rechange

OPCIONES - OPTIONS - OPTIONS

Parrilla adicional 650X530 GN2/1	650X530 GN2/1 Extra shelf	Grille additionnelle 650X530 GN2/1	55 € x ud
Barras carniceras	Bars for meat set	Tube de boucher	135 € x set
Set 4 ruedas	4 Castors set	Jeu 4 roulettes	98 € x set
Registrador de alarmas HACCP	HACCP alarm recorder	Enregistreur d'alarme HACCP	consultar
Respaldo inox	Stainless steel rear side	Soutien en inox	consultar

Características técnicas y constructivas sujetas a variación sin previo aviso. / We reserve the right to change specifications without prior notice. / Sujet technique et la conception de modifications sans préavis.

ARG-75-1-PF 2.728 €	ARG-75-2-PF 2.835 €	ARGV-75-1-PF 3.092 €
AG-75-1-C-PF 3.655 €	AG-75-2-C-PF 3.708 €	AGV-75-1-C-PF 4.163 €

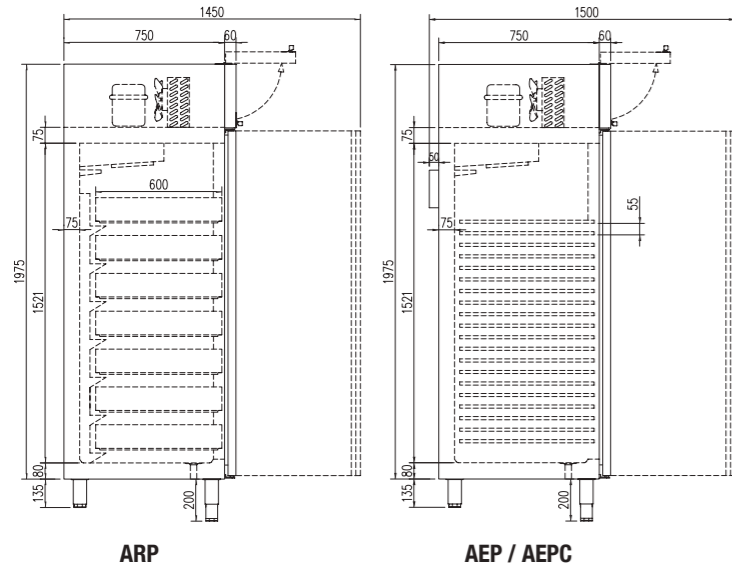

ARGP-75-2
Departamento pescado
Fish department
Département poisson

ARGM-75-2
Departamento congelados
Frozen department
Département gelé



AEP-75
PASTELERÍA
PASTRY
PÂTISSERIE

ARP-75-1
Pescado
Fish
Poisson

CARACTERÍSTICAS TÉCNICAS	TECHNICAL DATA	CARACTÉRISTIQUES TECHNIQUES
<ul style="list-style-type: none"> • ARGP departamento pescado • ARGM departamento congelación • ARP refrigeración pescado • AEP refrigeración pastelero • AEPC congelación pastelero 	<ul style="list-style-type: none"> • ARGP fish department • ARGM frozen department • ARP fish cooling • AEP pastry cooling • AEPC pastry freezing 	<ul style="list-style-type: none"> • Argp département de poisson • ARGM département congélation • ARP poissons de refroidissement • AEP refroidissement de pâtisserie • AEPC gel de boulanger

Ver características técnicas en página 290 / See technical data in page 290 / Voir caractéristiques techniques page 290

* Gas opcional / * Optional gas / * Gaz optionnel

Modelo Modèle	Largo Longueur mm	Alto Hauteur mm	Fondo Profondeur mm	Rango Range Gamme	Estantes Shelves Étagères GN 2/1	Cajas pescado Fish boxes Boîtes poissons	Pares de guías Sets of slides Kit de guides	Capacidad Capacity Exposition L	Voltaje Voltage Tension	Refrig. Coolant Frigorigène	Potencia Frig. Frig Power Puissance Frig. W	Consumo Nominal Nominal Consumption Consommation Nominale W	Rango Range Gamme	clase climate 2015/1094 EN16825	Rango Range Gamme
AEP-75	680	2130	850	-2°C +8°C	0	0	20	645	230 V-50 Hz	R-290	502	243	C	5 (40°C 40%)	
AEPC-75	680	2130	850	-20°C -15°C	0	0	20	645	230 V-50 Hz	R-290	606	553	E	4 (30°C 55%)	
ARP-75	680	2130	850	-5°C -1°C	0	7	7	645	230 V-50 Hz	R-290	845	434	-	5 (40°C 40%)	
ARGP-75	680	2130	850	-2°C / -5°C +8°C / -1°C	1	3	4	610	230 V-50 Hz	R-290+R-290	502 + 502	296 + 369	-	-	
ARGM-75	680	2130	850	-2°C / -20°C +8°C / -15°C	2	0	2	610	230 V-50 Hz	R-290+R-290	502 + 361	296 + 642	-	4 (30°C 55%)	

PVP de opcionales incluidos en equipo, no como repuesto / PVP of options included in the equipment, not as a spare part / PVP d'options incluses dans l'équipement, pas en tant que pièce de rechange

OPCIONES - OPTIONS - OPTIONS			
Parrilla adicional 60x40	60x40 extra shelf	Grille additionnelle 60x40	28 € x ud
Set adicional guías 60x40	60x40 slides extra set	Kit supplémentaire de guides 60x40	24 € x set
Set 4 ruedas	4 Castors set	Jeu 4 roulettes	98 € x ud
Registrador de alarmas HACCP	HACCP alarm recorder	Enregistreur d'alarme HACCP	consultar - consult - consulter
Respaldo inox	Stainless steel rear side	Soutien en inox	consultar - consult - consulter
Tropicalizado 43°C	Tropicalized to 43°C	Tropicalisé 43°C	consultar - consult - consulter
230V 60hz / 115v 60hz	230V 60hz / 115v 60hz	230V 60hz / 115v 60hz	consultar - consult - consulter

	ARGM-75-2	4.290 €
	ARGP-75-2	3.551 €
	ARP-75	3.272 €
	AEP-75	2.970 €
	AEPC-75	3.894 €

Características técnicas y constructivas sujetas a variación sin previo aviso. / We reserve the right to change specifications without prior notice. / Sujet technique et la conception de modifications sans préavis.



AE-125-3



AE-125-2



AE-125-2-E

LED
□□□□□□

CARACTERÍSTICAS TÉCNICAS	TECHNICAL DATA	CARACTÉRISTIQUES TECHNIQUES
<ul style="list-style-type: none"> • AE refrigeración • AEC congelación • AE-E refrigeración puerta cristal • AEC-E congelación puerta cristal • AEM departamento congelación 	<ul style="list-style-type: none"> • AE cooling • AEC freezing • AE-E cooling double glazed doors • AEC-E freezing double glazed doors • AEM freezing department 	<ul style="list-style-type: none"> • AE refroidissement • AEC congélation • AE-E refroidissement double vitrage • AEC-E congélation double vitrage • AEM département de congélation

Ver características técnicas en página 290 / See technical data in page 290 / Voir caractéristiques techniques page 290

* Gas opcional / * Optional gas / * Gaz optionnel

Modelo Modelé	Largo Longueur mm	Alto Hauteur mm	Fondo Profondeur mm	Rango Range Gamme	Estantes Shelves Étagères	Pares de guías Sets of slides Kit de guides	Capacidad Capacity Exposition L	Tensión monofásica Single phase voltage Tension monophasique	Refrig. Coolant Frigorigène	Potencia Frig. Frig Power Puissance Frig. W	Consumo Consumption Consommation W	Rango Range Gamme	clase climate 2015/1094 EN16825 Rango Range Gamme
AE-125	1250	2040	700	-2°C +8°C	6	6	964	230 V - 50 Hz	R-290	543	416	D	5 40°C 40%
AE-125-E	1250	2040	700	-2°C +8°C	8	8	964	230 V - 50 Hz	R-290	543	434	-	4 30°C 55%
AEC-125	1250	2040	700	-20°C -15°C	6	6	964	230 V - 50 Hz	R-290	833	810	E	4 30°C 55%
AEC-125-E	1250	2040	700	-20°C -15°C	8	8	964	230 V - 50 Hz	R-290	833	828	-	4 30°C 55%
AEM-125	1250	2040	700	-2°C + 8°C 20°C -15°C	6	6	830	230 V - 50 Hz	R-290 + R290	271 + 385	213 + 432	-	4 30°C 55%

PVP de opcionales incluidos en equipo, no como repuesto / PVP of options included in the equipment, not as a spare part / PVP d'options incluses dans l'équipement, pas en tant que pièce de rechange

OPCIONES - OPTIONS - OPTIONS			
Parrilla adicional	Extra shelf	Grille additionnelle	46 € x ud
Set adicional guías	Slides extra set	Kit supplémentaire de guides	29 € x set
Cerradura puerta inox	Solid door lock	Serrure à porte inox	24 € x ud
Cerradura puerta cristal	Glass door lock	Serrure à porte en verre	61 € x ud
Barras carniceras	Bars for meat set	Tube de boucher	134 € x set
Set 6 ruedas	6 Castors set	Jeu 6 roulettes	146 € x set
Registrador de alarmas HACCP	HACCP alarm recorder	Enregistreur d'alarme HACCP	consultar - consult - consulter
Tropicalizado 43°C	Tropicalized to 43°C	Tropicalisé 43°C	consultar - consult - consulter
Respaldo inox	Stainless steel rear side	Soutien en inox	consultar - consult - consulter
230V 60hz / 115v 60hz	230V 60hz / 115v 60hz	230V 60hz / 115v 60hz	consultar - consult - consulter

Características técnicas y constructivas sujetas a variación sin previo aviso. / We reserve the right to change specifications without prior notice. / Sujet technique et la conception de modifications sans préavis.

AE-125-2 3.077 €	AE-125-2-E 3.676 €	AEM-125-2 5.144 €
AEC-125-2 4.137 €	AEC-125-2-E 4.871 €	



AEP-125



AEP-125-40



AEP-125-14

Ver características técnicas en página 290 / See technical data in page 290 / Voir caractéristiques techniques page 290

* Gas opcional / * Optional gas / * Gaz optionnel

Modelo Model Modèle	Largo Length Longueur mm	Alto Height Hauteur mm	Fondo Depth Profondeur mm	Rango Range Gamme	Estantes Shelves Étagères	Cajas pescado Fish boxes Boîtes poissons	Pares de guías Sets of slides Kit de guides	Capacidad Capacity Exposition L	Tensión monofásica Single phase voltage Tension monophasique	Refrig. Coolant Frigorigène	Potencia Frig. Frig Power Puissance Frig. W	Consumo Consumption Consommation W	clase climate 2015/1094 EN16825 Rango Range Gamme
AEP-125-14	1250	2040	770	-1°C +5°C	0	14	14	979	230 V - 50 Hz	R-290	833	810	5 (40°C 40%)
AEP-125-40	1250	2040	770	0°C +8°C	6	0	38	979	230 V - 50 Hz	R-290	543	434	5 (40°C 40%)
AEPC-125-40	1250	2040	770	-20°C -15°C	6	0	38	979	230 V - 50 Hz	R-290	833	810	4 (30°C 55%)
AEP-125-E-40	1250	2040	770	0°C +8°C	6	0	38	979	230 V - 50 Hz	R-290	543	434	4 (30°C 55%)
AEPC-125-E-40	1250	2040	770	-20°C -15°C	6	0	38	979	230 V - 50 Hz	R-290 + R290	833	824	4 (30°C 55%)

PVP de opcionales incluidos en equipo, no como repuesto / PVP of options included in the equipment, not as a spare part / PVP d'options incluses dans l'équipement, pas en tant que pièce de rechange

OPCIONES - OPTIONS - OPTIONS			
Parrilla adicional 600 X 400	600 X 400 Extra shelf	Grille additionnelle 600 X 400	27 € x ud
Set adicional guías	Slides extra set	Kit supplémentaire de guides	29 € x set
Cerradura puerta inox	Solid door lock	Serrure à porte inox	24 € x ud
Cerradura puerta cristal	Glass door lock	Serrure à porte en verre	61 € x ud
Barras carniceras	Bars for meat set	Tube de boucher	134 € x set
Set 6 ruedas	6 Castors set	Jeu 6 roulettes	146 € x set
Registrador de alarmas HACCP	HACCP alarm recorder	Enregistreur d'alarme HACCP	consultar - consult - consulter
Tropicalizado 43°C	Tropicalized to 43°C	Tropicalisé 43°C	consultar - consult - consulter
Respaldo inox	Stainless steel rear side	Soutien en inox	consultar - consult - consulter
230V 60hz / 115v 60hz	230V 60hz / 115v 60hz	230V 60hz / 115v 60hz	consultar - consult - consulter

Características técnicas y constructivas sujetas a variación sin previo aviso. / We reserve the right to change specifications without prior notice. / Sujet technique et la conception de modifications sans préavis.

AEP-125-14 3.859 €	AEP-125-40 3.605 € AEP-125-40-E 3.751 €	AEPC-125-40 4.670 € AEPC-125-40-E 5.150 €

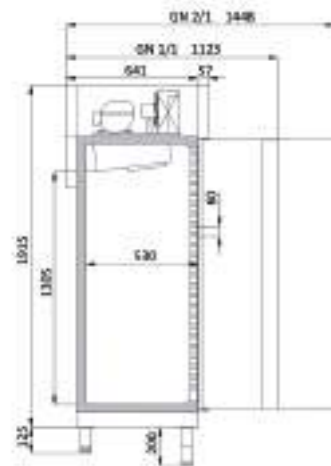

LED
□□□□□□



AG-125-E-1/1-2/1



AG-125-1/1-2/1

CARACTERÍSTICAS TÉCNICAS

- AG refrigeración
- AGC congelación
- AG-E refrigeración puerta cristal
- AGC-E congelación puerta cristal

TECHNICAL DATA

- AG cooling
- AGC freezing
- AG-E cooling double glazed doors
- AGC-E freezing double glazed doors

CARACTÉRISTIQUES TECHNIQUES

- AG refroidissement
- AGC congélation
- AG-E refroidissement double vitrage
- AGC-E congélation double vitrage

Ver características técnicas en página 290 / See technical data in page 290 / Voir caractéristiques techniques page 290

* Gas opcional / * Optional gas / * Gaz optionnel

Modelo Model Modèle	Largo Length Longueur mm	Alto Height Hauteur mm	Fondo Depth Profondeur mm	Rango Range Gamme	Estantes Shelves Étagères	Pares de guías Sets of slides Kit de guides	Capacidad Capacity Exposition L	Voltaje Voltage Tension	Refrig. Coolant Frigorigène	Potencia Frig. Frig Power Puissance Frig. W	Consumo Nominal Nominal Consumption Consommation Nominale W	Rango Range Gamme	clase climate 2015/1094 EN16825 Rango Range Gamme
AG-125	1250	2040	700	-2°C +8°C	6	6	964	230 V - 50 Hz	R-290	543	416	D	5 (40°C 40%)
AGC-125	1250	2040	700	-20°C -15°C	6	6	964	230 V - 50 Hz	R-290	833	810	E	4 (30°C 55%)
AG-E-125	1250	2040	700	-2°C +8°C	8	8	964	230 V - 50 Hz	R-290	543	434	-	4 (30°C 55%)
AGC-E-125	1250	2040	700	-20°C -15°C	8	8	964	230 V - 50 Hz	R-290	833	828	-	4 (30°C 55%)

PVP de opcionales incluidos en equipo, no como repuesto / PVP of options included in the equipment, not as a spare part / PVP d'options incluses dans l'équipement, pas en tant que pièce de rechange

OPCIONES - OPTIONS - OPTIONS

Parrilla adicional 650X530 GN2/1	650X530 GN2/1 Extra shelf	Grille additionnelle 650X530 GN2/1	55 € x ud
Parrilla adicional 530 X 325 GN1/1	530 X 325 GN1/1 extra shelf	Grille additionnelle 530 X 325 GN1/1	28 € x ud
Set adicional guías GN	GN slides extra set	Kit supplémentaire de guides GN	29 € x set
Set 6 ruedas	6 Castors set	Jeu 6 roulettes	146 € x ud
Registrador de alarmas HACCP	HACCP alarm recorder	Enregistreur d'alarme HACCP	consultar - consult - consulter
Tropicalizado 43°C	Tropicalized to 43°C	Tropicalisé 43°C	consultar - consult - consulter
Respaldo inox	Stainless steel rear side	Soutien en inox	consultar - consult - consulter
230V 60hz / 115v 60hz	230V 60hz / 115v 60hz	230V 60hz / 115v 60hz	consultar - consult - consulter

Características técnicas y constructivas sujetas a variación sin previo aviso. / We reserve the right to change specifications without prior notice. / Sujet technique et la conception de modifications sans préavis.

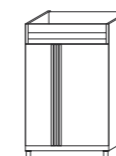

AG-125-1/1-2/1 **3.270 €**
AGC-125-1/1-2/1 **4.327 €**



AG-125-E-1/1-2/1 **3.804 €**
AGC-125-E-1/1-2/1 **5.020 €**

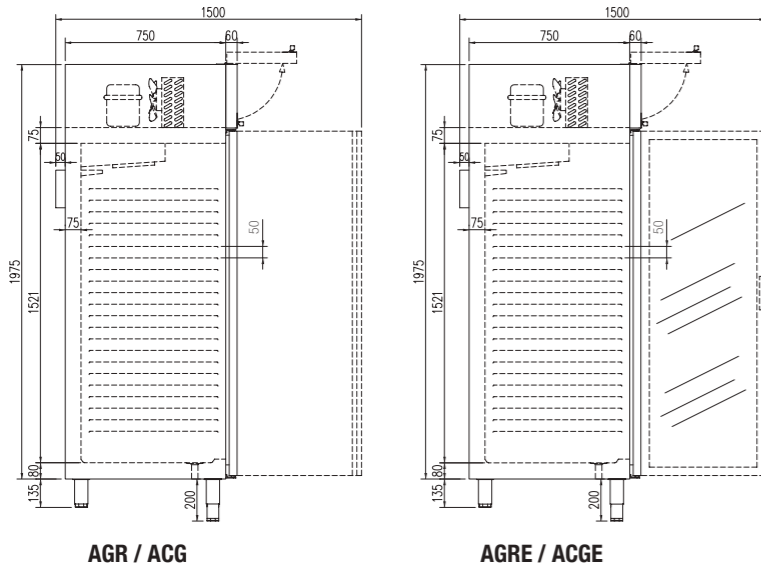

CARACTERÍSTICAS TÉCNICAS	TECHNICAL DATA	CARACTÉRISTIQUES TECHNIQUES
<ul style="list-style-type: none"> • ARG refrigeración • AG-C congelación • ARGV refrigeración puerta cristal • AGV-C congelación puerta cristal 	<ul style="list-style-type: none"> • ARG cooling • AG-C freezing • ARGV cooling double glazed doors • AGV-C freezing double glazed doors 	<ul style="list-style-type: none"> • ARG refroidissement • AG-C congélation • ARGV porte en verre réfrigération • AGV-C porte en verre congélation

Ver características técnicas en página 290 / See technical data in page 290 / Voir caractéristiques techniques page 290



ARG-140-2



ARGV-140-2

* Gas opcional / * Optional gas / * Gaz optionnel

Modelo Model Modèle	Largo Length Longueur mm	Alto Height Hauteur mm	Fondo Depth Profondeur mm	Rango Range Gamme	Estantes Shelves Étagères GN 2/1	Nivel de estantes Level shelves Niveau étagères	Capacidad Capacity Exposition L	Voltaje Voltage Tension	Refrig. Coolant Frigorigène	Potencia Frig. Frig Power Puissance Frig. W	Consumo Nominal Nominal Consumption Consommation Nominale W	Rango Range Gamme	Rango Range Gamme
ARG-140-PF	1370	2130	850	-2°C +8°C	6	24	1404	230 V - 50 Hz	R-290	845	373	D	5 (40°C 40%)
AG-140-C-PF	1370	2130	850	-20°C -15°C	6	24	1282	230 V - 50 Hz	R-290	907	952	D	4 (30°C 55%)
ARGV-140-PF	1370	2130	850	-2°C +8°C	8	24	1404	230 V - 50 Hz	R-290	845	396	-	4 (30°C 55%)
AGV-140-C-PF	1370	2130	850	-20°C -15°C	8	24	1282	230 V - 50 Hz	R-290	907	962	-	4 (30°C 55%)

LED
□□□□□

PVP de opcionales incluidos en equipo, no como repuesto / PVP of options included in the equipment, not as a spare part / PVP d'options incluses dans l'équipement, pas en tant que pièce de rechange

OPCIONES - OPTIONS - OPTIONS			
Parrilla adicional GN 2/1	GN 2/1 extra shelf	Grille additionnelle GN 2/1	55 € x ud
Set adicional guías GN 2/1	GN 2/1 slides extra set	Kit supplémentaire de guides GN 2/1	30 € x set
Barras carniceras	Bars for meat set	Tube de boucher	135 € x ud
Set 6 ruedas	6 Castors set	Jeu 6 roulettes	146 € x set
Registrador de alarmas HACCP	HACCP alarm recorder	Enregistreur d'alarme HACCP	consultar - consult - consulter
Respaldo inox	Stainless steel rear side	Soutien en inox	consultar - consult - consulter
Tropicalizado 43°C	Tropicalized to 43°C	Tropicalisé 43°C	consultar - consult - consulter
230V 60hz / 115v 60hz	230V 60hz / 115v 60hz	230V 60hz / 115v 60hz	consultar - consult - consulter

ARG-140-2 4.229 €	ARG-140-3 4.243 €	ARG-140-4 4.297 €	ARGV-140-2 4.640 €
AG-140-2-C 5.095 €	AG-140-3-C 5.189 €	AG-140-4-C 5.255 €	AGV-140-2-C 5.992 €

Características técnicas y constructivas sujetas a variación sin previo aviso. / We reserve the right to change specifications without prior notice. / Sujet technique et la conception de modifications sans préavis.

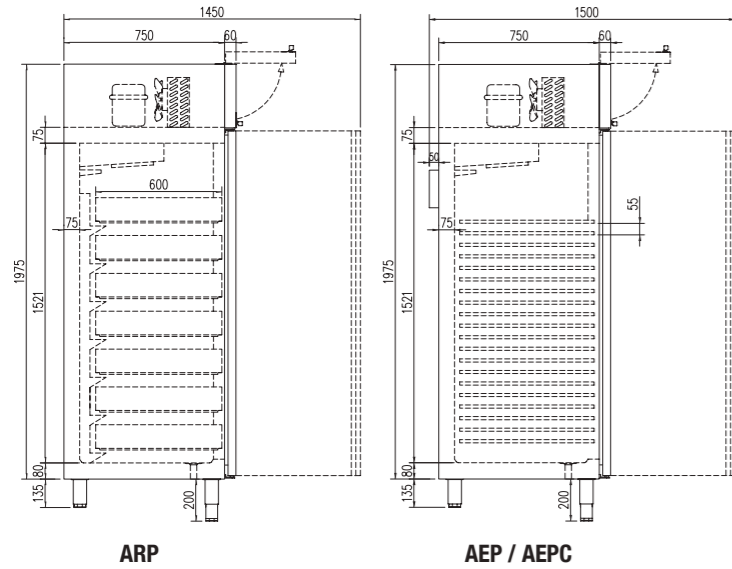

ARGP-140-3
 Departamento pescado
 Fish department
 Département poisson

ARGM-140-3
 Departamento congelados
 Frozen department
 Département gelé



AEP-140-2
 PASTERÍA
 PASTRY
 PÂTISSERIE



ARP-140-2
 PESCADO
 FISH
 POISSON

CARACTERÍSTICAS TÉCNICAS

- ARP refrigeración pescado
- AEP refrigeración pastelero
- AEPC congelación pastelero
- ARGP departamento pescado
- ARGM departamento congelación

TECHNICAL DATA

- ARP fish cooling
- AEP pastry cooling
- AEPC pastry freezing
- ARGP fish department
- ARGM freezing department

CARACTÉRISTIQUES TECHNIQUES

- ARP poissons de refroidissement
- AEP refroidissement de pâtisserie
- AEPC gel de boulanger
- ARGP département de poisson
- ARGM département congélation

Ver características técnicas en página 290 / See technical data in page 290 / Voir caractéristiques techniques page 290

* Gas opcional / * Optional gas / * Gaz optionnel

Modelo Model Modèle	Largo Length Longueur mm	Alto Height Hauteur mm	Fondo Depth Profondeur mm	Rango Range Gamme	Estantes Shelves Étagères GN 2/1	Cajones Drawers Tiroirs	Pares de guías Sets of slides Kit de guides	Capacidad Capacity Exposition L	Voltaje Voltage Tension	Refrig. Coolant Frigorigène	Potencia Frig. Frig Power Puissance Frig. W	Consumo Nominal Nominal Consumption Consommation Nominale W	Rango Range Gamme	clase climate 2015/1094 EN16825	clase climate 2015/1094 EN16825
AEP-140	1370	2130	850	-2°C +8°C	0	0	40	1404	230 V - 50 Hz	R-290	845	373	D	5 (40°C 40%)	
AEPC-140	1370	2130	850	-20°C -15°C	0	0	40	1404	230 V - 50 Hz	R-290	907	952	E	4 (30°C 55%)	
ARP-140	1370	2130	850	-5°C -1°C	0	14	14	1404	230 V - 50 Hz	R-290	845	479	-	5 (40°C 40%)	
ARGP-140-2	1370	2130	850	-2°C / -5°C +8°C / -1°C	4	3	7	1370	230 V - 50 Hz	R-290 +R-290	502 + 845	243 + 431	-	-	
ARGP-140-3/4	1370	2130	850	-2°C / -5°C +8°C / -1°C	4	3	7	1370	230 V - 50 Hz	R-290 +R-290	845 + 502	373 + 369	-	-	
ARGM-140-2	1370	2130	850	-2°C / -20°C +8°C / -15°C	6	0	6	1290	230 V - 50 Hz	R-290 +R-290	502 + 606	243 + 553	-	-	
ARGM-140-3/4	1370	2130	850	-2°C / -20°C +8°C / -15°C	5	0	2	1370	230 V - 50 Hz	R-290 +R-290	845 + 606	361 + 553	-	-	

PVP de opcionales incluidos en equipo, no como repuesto / PVP of options included in the equipment, not as a spare part / PVP d'options incluses dans l'équipement, pas en tant que pièce de rechange

OPCIONES - OPTIONS - OPTIONS

Parrilla adicional 600 X 400	600 X 400 extra shelf	Grille additionnelle 600 X 400	28 € x ud
Set adicional guías 600 X 400	600 X 400 slides extra set	Kit supplémentaire de guides 600 X 400	24 € x set
Barras carniceras	Bars for meat set	Tube de boucher	135 € x ud
Set 6 ruedas	6 Castors set	Jeu 6 roulettes	146 € x ud
Registrador de alarmas HACCP	HACCP alarm recorder	Enregistreur d'alarme HACCP	consultar - consult - consulter
Respaldo inox	Stainless steel rear side	Soutien en inox	consultar - consult - consulter
Tropicalizado 43°C	Tropicalized to 43°C	Tropicalisé 43°C	consultar - consult - consulter
230V 60hz / 115v 60hz	230V 60hz / 115v 60hz	230V 60hz / 115v 60hz	consultar - consult - consulter

Características técnicas y constructivas sujetas a variación sin previo aviso. / We reserve the right to change specifications without prior notice. / Sujet technique et la conception de modifications sans préavis.

ARP-140-2 5.270 €	ARGP-140-3 4.860 €	ARGM-140-3 5.248 €	AEP-140-2 4.940 €
			AEPC-140-2 5.906 €

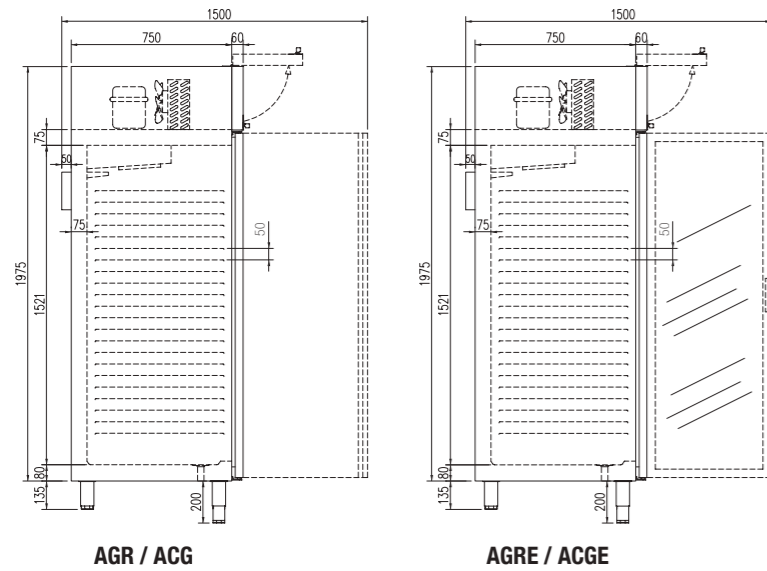

CARACTERÍSTICAS TÉCNICAS	TECHNICAL DATA	CARACTÉRISTIQUES TECHNIQUES
<ul style="list-style-type: none"> • ARG refrigeración • AG-C congelación • ARGV refrigeración puerta cristal • AGV-C congelación puerta cristal 	<ul style="list-style-type: none"> • ARG cooling • AG-C freezing • ARGV cooling double glazed doors • AGV-C freezing double glazed doors 	<ul style="list-style-type: none"> • ARG refroidissement • AG-C congélation • ARGV porte en verre réfrigération • AGV-C porte en verre congélation

Ver características técnicas en página 290 / See technical data in page 290 / Voir caractéristiques techniques page 290

* Gas opcional / * Optional gas / * Gaz optionnel

Modelo Model Modèle	Largo Length Longueur mm	Alto Height Hauteur mm	Fondo Depth Profondeur mm	Rango Range Gamme	Estantes Shelves Étagères GN 2/1	Nivel de estantes Level shelves Niveau étagères	Capacidad Capacity Exposition L	Voltaje Voltage Tension	Refrig. Coolant Frigorigène	Potencia Frig. Frig Power Puissance Frig. W	Consumo Nominal Nominal Consumption Consommation Nominale W	Rango Range Gamme	clase climate 2015/1094 EN16825	Rango Range Gamme
ARG-2003	2055	2130	850	-2°C +8°C	9	18	2197	230 V - 50 Hz	R-290	1702	897	D	5 (40°C 40%)	
ACG-2003	2055	2130	850	-20°C -15°C	9	18	2197	230 V - 50 Hz	R-290	1814	1680	E	4 (30°C 55%)	
ARGE-2003	2055	2130	850	-2°C +8°C	12	24	2197	230 V - 50 Hz	R-290	1702	943	-	5 (40°C 40%)	
ARG-2003	2055	2130	850	-2°C +8°C	12	24	2197	230 V - 50 Hz	R-290	1814	1726	-	5 (40°C 40%)	

PVP de opcionales incluidos en equipo, no como repuesto / PVP of options included in the equipment, not as a spare part / PVP d'options incluses dans l'équipement, pas en tant que pièce de rechange

OPCIONES - OPTIONS - OPTIONS			
Parrilla adicional GN 2/1	GN 2/1 extra shelf	Grille additionnelle GN 2/1	55 € x ud
Set adicional guías GN 2/1	GN 2/1 slides extra set	Kit supplémentaire de guides GN 2/1	30 € x set
Barras carniceras	Bars for meat set	Tube de boucher	135 € x ud
Set 6 ruedas	6 Castors set	Jeu 6 roulettes	146 € x set
Registrador de alarmas HACCP	HACCP alarm recorder	Enregistreur d'alarme HACCP	consultar - consult - consulter
Respaldo inox	Stainless steel rear side	Soutien en inox	consultar - consult - consulter
Tropicalizado 43°C	Tropicalized to 43°C	Tropicalisé 43°C	consultar - consult - consulter
230V 60hz / 115v 60hz	230V 60hz / 115v 60hz	230V 60hz / 115v 60hz	consultar - consult - consulter

ARG-210-3	5.468 €	ARG-210-4	5.690 €	ARG-210-5	5.914 €	ARG-210-6	6.128 €	ARGV-210-3	6.956 €
AG-210-3-C	6.765 €	AG-210-4-C	6.986 €	AG-210-5-C	7.208 €	AG-210-6-C	7.422 €	AGV-210-3-C	8.043 €

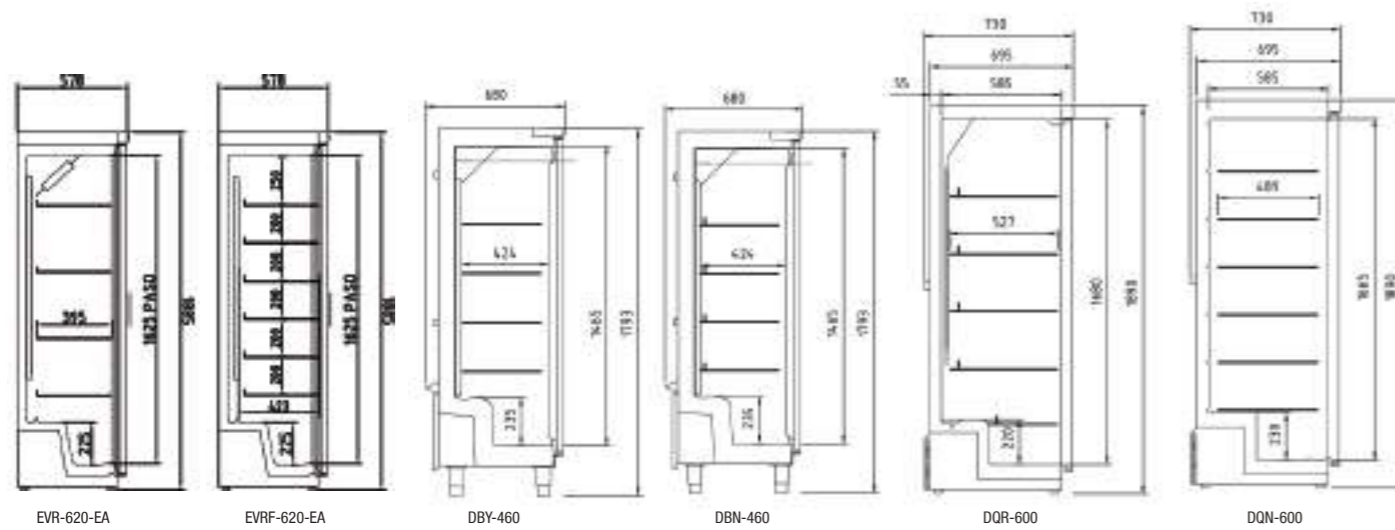

DBY-460



DQN-600



DQR-600



EVRF-620-EA

CARACTERÍSTICAS TÉCNICAS	TECHNICAL DATA	CARACTÉRISTIQUES TECHNIQUES
<ul style="list-style-type: none"> Exterior en acero plastificado blanco Interior en poliestireno termoconformado blanco sanitario Modelo 600: preparado para GN 2/1 (650X530) Modelo 460: preparado para estante 60x40 Modelo 620: preparado para estante 520x395 (con barandilla) Puerta ciega blanca (inyectada con poliuretano de alta densidad), apertura reversible, con sistema de cierre automático y junta magnética Aislamiento de poliuretano inyectado, densidad 40 kg/m³, bajo GWP y efecto cero ODP Evaporación automática del agua de desescarche Termostato digital Refrigeración ventilada en modelos refrigeración (desescarche natural automática) Refrigeración estática en modelos de mantenimiento de congelados (desescarche manual) Reguladores de altura, ruedas o patas opcionales Clase climática 4 (30°C 55% H.R.) 	<ul style="list-style-type: none"> White plastic-coated steel exterior Interior in sanitary white thermoformed polystyrene Model 600: prepared for GN 2/1 (650X530) Model 460: prepared for 60x40 shelf Model 620: prepared for 520x400 shelf (with railing) Solid white door (injected with high-density polyurethane), reversible opening, with automatic closing system and magnetic gasket Injected polyurethane insulation, density 40 kg / m³, low GWP and zero ODP effect Automatic evaporation of defrost water Digital thermostat Ventilated cooling in refrigeration models (automatic natural defrost) Static cooling in frozen maintenance models (manual defrost) Height adjusters, wheels or optional legs Climatic class 4 (30°C 55% R.H.) 	<ul style="list-style-type: none"> Extérieur en acier plastifié blanc Intérieur en polystyrène thermoformé blanc sanitaire Modèle 600 : préparé pour GN 2/1 (650X530) Modèle 460 : préparé pour gril 60x40 Modèle 620 : préparé pour gril 520x400 (avec garde-corps) Porte blanche unie (injectée de polyuréthane haute densité), ouverture réversible, avec système de fermeture automatique et coupe-froid magnétique Isolation en polyuréthane injecté, densité 40 kg/m³, faible GWP et zéro effet ODP Évaporation automatique de l'eau de dégivrage thermostat numérique Réfrigération ventilée dans les modèles de réfrigération (dégivrage naturel automatique) Réfrigération statique dans les modèles de maintenance congelés (dégivrage manuel) Régulateurs de hauteur, roues ou pieds en option Classe climatique 4 (30°C 55% H.R.)

Modelo	Largo	Alto	Fondo	Rango	Capacidad	Potencia Frigorífica	Refrigerante	Etiqueta energética	Consumo Nominal
Model	Length	Height	Depth	Range	Capacity	Frig Power	Coolant	Energy label	Nominal Consumption
Modèle	Longueur	Hauteur	Profondeur	Gamme	Exposition	Puissance Frigorifique	Frigorigène	Label énergétique	Consommation Nominale
	mm	mm	mm		L	W		W	W
EVR-620-EA	620	1885	578	0°C + 7°C	348	236	R-600a	C	189
EVRF-620-EA	620	1885	578	-18°C -16°C	348	231	R-290	N / A	233
DBY 460	740	1800	680	+2°C + 8°C	400	170	R-600a	B	180
DBN 460	740	1800	680	-22°C -18°C	400	380	R-290	N / A	220
DQR 600	780	1890	730	+2°C + 10°C	600	235	R-600a	D	200
DQN 600	780	1890	730	-22°C -18°C	600	440	R-290	N / A	400

Opcionales consultar / Optional consult / Accessoires consulter

Características técnicas y constructivas sujetas a variación sin previo aviso. / We reserve the right to change specifications without prior notice. / Sujet technique et la conception de modifications sans préavis.

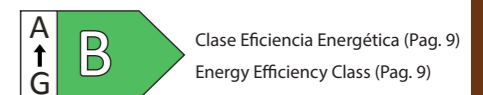

	EVR-620-EA 1.333 €		DBY-460 1.391 €		DQR-600 1.665 €
	EVRF-620-EA 1.580 €		DBN-460 1.665 €		DQN-600 1.739 €



ARMARIOS SECADO EMBUTIDOS SNACK CABINET FOR SAUSAGE MEAT ARMOIRES DE SÉCHAGE DE SAUCISSES



DASC-75/140 Página 347

Armario secado embutidos 75/140
Sausage meat snack cabinet 75/140
Armoire secher snack 75 /140



ARMARIOS MADURACIÓN DE CARNE “DRY AGING” DRY AGING DISPLAY CABINET ARMOIRES À VIANDES VIEILLISSEMENT À SEC



DDAV Página 353

Armario maduración de carnes
Meat maturing cabinet
Armoire à viande



DDA Página 355

Armario maduración de carnes
Meat maturing cabinet
Armoire à viande

El **curado de embutidos**, es una técnica tradicional que se ha transmitido de generación en generación.

El proceso de **estufaje, fermentación y secado**, da como resultado un producto único y muy apreciado para el consumo.

Este proceso requiere un **espacio dedicado con temperatura y humedad controladas**, así como un **equipo especializado**.

En nuestra experiencia, **diferentes clientes necesitan diferentes configuraciones para obtener el mismo excelente producto final**.

Los orígenes de la elaboración del salami se remontan a civilizaciones antiguas, en particular a los romanos, quienes se cree que introdujeron la técnica en Europa. El salami era un alimento popular ya que era una fuente de proteína compacta y duradera.

El curado de embutidos, es un proceso de **conservación mediante el uso de sal y otros ingredientes como especias**, para evitar el crecimiento de bacterias dañinas. Esta mezcla se deja **fermentar y secar durante varias semanas o meses**, según el sabor y la textura deseados.

Durante el proceso de fermentación, las bacterias del ácido láctico descomponen los azúcares de la carne, lo que reduce el pH de la carne. Esto crea un ambiente ácido que inhibe el crecimiento de bacterias dañinas y le da al embutido su distintivo sabor.

A medida que avanza el proceso, el embutido **pierde humedad y se vuelve más denso**, lo que resulta en una textura más firme. El proceso de secado también concentra los sabores de las especias.

Además del sabor, el curado del embutido prolonga la vida útil de la carne.

La **sal, el curado y el procedimiento controlado en temperatura y humedad** ayudan a prevenir el deterioro.



Salami curing is a **time-honoured technique** that has been passed down through generations.

The process of **heat drying and fermenting** results in a **unique and flavorful product**.

This process requires a **dedicated temperature and humidity-controlled space**, as well as **specialized equipment**.

In our own experience, **different clients need different configurations to get the same excellent final product**.

The origins of salami-making can be traced back to ancient civilizations, particularly the Romans, who are believed to have introduced the technique to Europe. Salami was a popular food as it was a compact and long-lasting source of protein.

Salami curing is a process of **preserving meat by using salt and other ingredients, such as spices**, to prevent the growth of harmful bacteria. The mixture is then **stuffed into casings and left to ferment and dry for several weeks or months**, depending on the desired flavour and texture.

During the fermentation process, lactic acid bacteria break down the sugars in the meat which lowers the pH of the meat. This creates an acidic environment that inhibits the growth of harmful bacteria and gives the salami its distinctively flavour.

As the salami dries, it **loses moisture and becomes denser**, resulting in a firmer texture. The drying process also concentrates the flavours of the spices and curing agents.

In addition to the flavour, salami curing also provides a longer shelf life for the meat.

The **salt, curing agents and controlled procedure of temperature and humidity** help to prevent spoilage.



Detalle barras carniceras
Butcher bars detail
Détail des barres de boucherie



Estantes opcionales
Optional shelves
Étagères en option

CARACTERÍSTICAS TÉCNICAS

- Exterior en acero inox AISI-304, excepto el respaldo
- Interior en acero inox AISI-304, con aristas curvas y fondo embutido
- Puertas de apertura reversible, con sistema de cierre automático y burlete magnético (permanece abierta al superar los 90° de apertura)
- Contrapuerta inox embutida
- Luz interior LED
- KITS barras carniceras (3 barras por cada Kit), estante opcionales.
- Pies en tubo de acero inox ajustables en altura 135 - 200 mm
- Cuadro de mandos y rejilla ventilación motor, desmontables
- Unidad condensadora ventilada
- Resistencias para ciclo de estufaje, con termostato de seguridad de rearme automático (50°C OFF, 35°C ON)
- Ventiladores funcionamiento independiente frío - calor - humedad
- Evaporador sistema tiro forzado, con recubrimiento epoxi anticorrosión
- Paro ventiladores tiro forzado al abrir la puerta
- Evaporación automática del agua de descarche
- Aislamiento de poliuretano inyectado, densidad 40 Kg/m³, cero ODP y GWP
- 70 mm aislamiento en costados
- Control digital con eficiente gestión del consumo de energía y HACCP por conexión WIFI o BT (opcionales)
- 6 programas pre-configurados, reprogramables según necesidad del proceso.
- Cada programa cuenta con hasta 8 ciclos ajustables en tiempo, temperatura y humedad (sólo en modo secado)
- DASC y DASCV: un recinto para estufaje y secado
- DASC-S: un recinto sólo para secado
- DASC-ES: dos recintos independientes, una para estufaje y otro para secado

TECHNICAL DATA

- Exterior in AISI-304 stainless steel, except the backrest.
- Interior in AISI-304 stainless steel, with curved edges and deep-drawn bottom.
- Reversible opening doors, with automatic closing system and magnetic weather stripping (remains open when opening more than 90°)
- Embedded stainless steel shutter
- LED interior light
- Butcher bar KITS (3 bars for each Kit), optional shelf.
- Feet in stainless steel tube adjustable in height 135 - 200 mm
- Control panel and engine ventilation grill, removable
- Ventilated condensing unit
- Resistances for heating cycle, with automatic reset safety thermostat (50°C OFF, 35°C ON)
- Fans independent operation cold - heat - humidity
- Evaporator forced draft system, with anti-corrosion epoxy coating.
- Stop forced draft fans when opening the door
- Automatic evaporation of defrost water
- Injected polyurethane insulation, density 40 Kg/m³, zero ODP and GWP
- 70 mm insulation on sides
- Digital control with efficient management of energy consumption and HACCP by WIFI or BT connection (optional).
- 6 pre-configured programs, reprogrammable according to the needs of the process.
- Each program has up to 8 adjustable cycles in time, temperature and humidity (only in drying mode).
- DASC and DASCV: a room for stoving and drying
- DASC-S: a room only for drying
- DASC-ES: two independent rooms, one for stoves and the other for drying.

CARACTÉRISTIQUES TECHNIQUES

- Extérieur en acier inoxydable AISI-304, sauf le dossier.
- Intérieur en acier inoxydable AISI-304, avec bords incurvés et fond embouti.
- Portes à ouverture réversible, avec système de fermeture automatique et coupe-froid magnétique (reste ouverte à plus de 90° d'ouverture)
- Obturbateur en acier inoxydable intégré
- Eclairage intérieur à DEL
- KITS de barres de boucherie (3 barres pour chaque Kit), étagère en option.
- Pieds en tube inox réglables en hauteur 135 - 200 mm
- Tableau de commande et grille d'aération du moteur, amovibles
- Groupe de condensation ventilé
- Résistances pour cycle de chauffe, avec thermostat de sécurité à réarmement automatique (50°C OFF, 35°C ON)
- Fonctionnement indépendant des ventilateurs froid - chaud - humidité
- Système à tirage forcé de l'évaporateur, avec revêtement époxy anti-corrosion.
- Arrêtez les ventilateurs à tirage forcé lors de l'ouverture de la porte
- Evaporation automatique de l'eau de dégivrage
- Isolation en polyuréthane injecté, densité 40 Kg/m³, zéro ODP et GWP
- Isolation de 70 mm sur les côtés
- Commande numérique avec gestion efficace de la consommation d'énergie et HACCP par connexion WIFI ou BT (en option).
- 6 programmes pré-configurés, reprogrammables selon les besoins du process.
- Chaque programme a jusqu'à 8 cycles réglables en temps, température et humidité (uniquement en mode séchage).
- DASC et DASCV : une salle d'étuvage et de séchage
- DASC-S : une pièce uniquement pour le séchage
- DASC-ES : deux pièces indépendantes, une pour les poêles et l'autre pour le séchage.

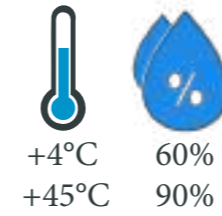

Estufaje Dripping Secado Drying

DASCV-751

DASC-ES-752

Modelo / Model / Modèle	Largo / Length / Longueur mm	Alto / Height / Hauteur mm	Fondo / Depth / Profondeur mm	Rango / Range / Gamme	Estantes / Shelves / Étagères GN 2/1	Barras carniceras / Butcher bars / Barres de viande	Capacidad / Capacity / Exposition L	Estufaje Dripping / Poêle	Secado Drying	Voltaje / Voltage / Tension	Refrig. Coolant / Frigorigène	Potencia Frig. / Frig Power / Puissance Frig. W	Consumo Nominal / Nominal Consumption / Consommation Nominale W	clase climate 2015/1094 EN16825 Rango / Range / Gamme
DASC-751	680	2160	735	+4°C +30°C	Opc.	3 KIT	505	✓	✓	230 V - 50 Hz	R-290	490	812	5 (40°C 40%)
DASCV-751	680	2160	735	+4°C +30°C	Opc.	3 KIT	505	✓	✓	230 V - 50 Hz	R-290	490	812	5 (40°C 40%)
DASC-S-751	680	2160	735	+4°C +16°C	Opc.	3 KIT	505	NO	✓	230 V - 50 Hz	R-290	490	265	5 (40°C 40%)
DASC-ES-752	680	2160	735	+4°C +30°C	Opc.	2 KIT	245+245	✓	✓	230 V - 50 Hz	R-290	630	916	5 (40°C 40%)

CICLO - CYCLE	tiempo- time		temperatura- temperature		humedad*- humidity*	
	min	max	min	max	min	max
ESTUFAJE - DRIPPING	1 h	240 h	22°C	30°C	no	no
SECADO - DRYING	1 h	240 h	4°C	16°C	50%	90%

PVP de opcionales incluidos en equipo, no como repuesto / PVP of options included in the equipment, not as a spare part / PVP d'options incluses dans l'équipement, pas en tant que pièce de rechange

OPCIONES - OPTIONS - OPTIONS

Parrilla adicional	Extra shelf	Grille additionnelle	35 € x ud
Parrilla adicional intermedia	Extra middle shelf	Grille intermédiaire supplémentaire	20 € x set
Barras carniceras	Bars for meat set	Tube de boucher	135 € x set
Set 4 ruedas	4 Castors set	Jeu 4 roulettes	98 € x set
Set 6 ruedas	6 Castors set	Jeu 6 roulettes	146 € x set
Cerradura puerta inox	Stainless steel door lock	Serrure porte en inox	25 € x ud
Conexion WIFI o BT	WIFI or BT module	WIFI ou BT modulé	146 € x ud
Respaldo inox	Stainless steel rear side	Dos en acier inoxydable	consultar - consult - consulter
230V 60hz / 115v 60hz	230V 60hz / 115v 60hz	230V 60hz / 115v 60hz	consultar - consult - consulter



DASC-75-1 3.420 €
DASCV-75-1 3.915 €

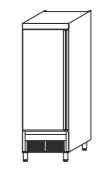

DASC-S-75-1 2.920 €
DASC-ES-75-2 4.244 €

Características técnicas y constructivas sujetas a variación sin previo aviso. / We reserve the right to change specifications without prior notice. / Sujet technique et la conception de modifications sans préavis.

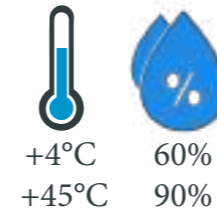

DASC-ES-140-3

CARACTERÍSTICAS TÉCNICAS

- Exterior en acero inox AISI-304, excepto el respaldo
- Interior en acero inox AISI-304, con aristas curvas y fondo embutido
- Puertas de apertura reversible, con sistema de cierre automático y burlete magnético (permanece abierta al superar los 90° de apertura)
- Contrapuerta inox embutida
- Luz interior LED
- KITS barras carniceras (3 barras por cada Kit), estante opcionales.
- Pies en tubo de acero inox ajustables en altura 135 - 200 mm
- Cuadro de mandos y rejilla ventilación motor, desmontables
- Unidad condensadora ventilada
- Resistencias para ciclo de estufaje, con termostato de seguridad de rearme automático (50°C OFF, 35°C ON)
- Ventiladores funcionamiento independiente frío - calor - humedad
- Evaporador sistema tiro forzado, con recubrimiento epoxi anticorrosión
- Paro ventiladores tiro forzado al abrir la puerta
- Evaporación automática del agua de descarche
- Aislamiento de poliuretano inyectado, densidad 40 Kg/m³, cero ODP y GWP
- 70 mm aislamiento en costados
- Control digital con eficiente gestión del consumo de energía y HACCP por conexión WIFI o BT (opcionales)
- 6 programas pre-configurados, reprogramables según necesidad del proceso.
- Cada programa cuenta con hasta 8 ciclos ajustables en tiempo, temperatura y humedad (sólo en modo secado)
- DASC y DASCV: un recinto para estufaje y secado
- DASC-S: un recinto sólo para secado
- DASC-ES: dos recintos independientes, una para estufaje y otro para secado

TECHNICAL DATA

- Exterior in AISI-304 stainless steel, except the backrest.
- Interior in AISI-304 stainless steel, with curved edges and deep-drawn bottom.
- Reversible opening doors, with automatic closing system and magnetic weather stripping (remains open when opening more than 90°)
- Embedded stainless steel shutter
- LED interior light
- Butcher bar KITS (3 bars for each Kit), optional shelf.
- Feet in stainless steel tube adjustable in height 135 - 200 mm
- Control panel and engine ventilation grill, removable
- Ventilated condensing unit
- Resistances for heating cycle, with automatic reset safety thermostat (50°C OFF, 35°C ON)
- Fans independent operation cold - heat - humidity
- Evaporator forced draft system, with anti-corrosion epoxy coating.
- Stop forced draft fans when opening the door
- Automatic evaporation of defrost water
- Injected polyurethane insulation, density 40 Kg/m³, zero ODP and GWP
- 70 mm insulation on sides
- Digital control with efficient management of energy consumption and HACCP by WIFI or BT connection (optional).
- 6 pre-configured programs, reprogrammable according to the needs of the process.
- Each program has up to 8 adjustable cycles in time, temperature and humidity (only in drying mode).
- DASC and DASCV: a room for stoving and drying
- DASC-S: a room only for drying
- DASC-ES: two independent rooms, one for stoves and the other for drying.

CARACTÉRISTIQUES TECHNIQUES

- Extérieur en acier inoxydable AISI-304, sauf le dossier.
- Intérieur en acier inoxydable AISI-304, avec bords incurvés et fond embouti.
- Portes à ouverture réversible, avec système de fermeture automatique et coupe-froid magnétique (reste ouverte à plus de 90° d'ouverture)
- Obturateur en acier inoxydable intégré
- Eclairage intérieur à DEL
- KITS de barres de boucherie (3 barres pour chaque Kit), étagère en option.
- Pieds en tube inox réglables en hauteur 135 - 200 mm
- Tableau de commande et grille d'aération du moteur, amovibles
- Groupe de condensation ventilé
- Résistances pour cycle de chauffe, avec thermostat de sécurité à réarmement automatique (50°C OFF, 35°C ON)
- Fonctionnement indépendant des ventilateurs froid - chaud - humidité
- Système à tirage forcé de l'évaporateur, avec revêtement époxy anti-corrosion.
- Arrêtez les ventilateurs à tirage forcé lors de l'ouverture de la porte
- Evaporation automatique de l'eau de dégivrage
- Isolation en polyuréthane injecté, densité 40 Kg/m³, zéro ODP et GWP
- Isolation de 70 mm sur les côtés
- Commande numérique avec gestion efficace de la consommation d'énergie et HACCP par connexion WIFI ou BT (en option).
- 6 programmes pré-configurés, reprogrammables selon les besoins du process.
- Chaque programme a jusqu'à 8 cycles réglables en temps, température et humidité (uniquement en mode séchage).
- DASC et DASCV : une salle d'étuvage et de séchage
- DASC-S : une pièce uniquement pour le séchage
- DASC-ES : deux pièces indépendantes, une pour les poêles et l'autre pour le séchage.

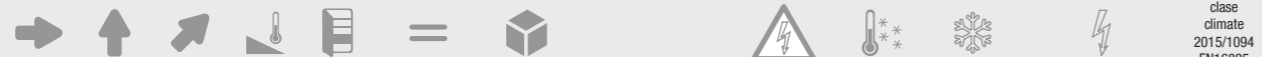

Modelo Model Modèle	Largo Length Longueur mm	Alto Height Hauteur mm	Fondo Depth Profondeur mm	Rango Range Gamme	Estantes Shelves Étagères GN 2/1	Barras carniceras Butcher bars Barres de viande	Capacidad Capacity Exposition L	Estufaje Dripping Poêle	Secado Drying	Voltaje Voltage Tension	Refrig. Coolant Frigorigène	Potencia Frig. Frig Power Puissance Frig. W	Consumo Nominal Nominal Consumption Consommation Nominale W	Rango Range Gamme
DASC-140-2	1370	2160	735	+4°C +30°C	Opc.	6 KIT	1201	✓	✓	230 V - 50 Hz	R-290	750	1175	5 (40°C 40%)
DASCV-140-2	1370	2160	735	+4°C +30°C	Opc.	6 KIT	1201	✓	✓	230 V - 50 Hz	R-290	750	1175	5 (40°C 40%)
DASC-S-140-2	1370	2160	735	+4°C +16°C	Opc.	6 KIT	1201	NO	✓	230 V - 50 Hz	R-290	750	360	5 (40°C 40%)
DASC-ES-140-3	1370	2160	735	+4°C +30°C	Opc.	4 + 1 KIT	956+245	✓	✓	230 V - 50 Hz	R-290	1065	1096	5 (40°C 40%)

PVP de opcionales incluidos en equipo, no como repuesto / PVP of options included in the equipment, not as a spare part / PVP d'options incluses dans l'équipement, pas en tant que pièce de rechange

OPCIONES - OPTIONS - OPTIONS

Parrilla adicional	Extra shelf	Grille additionnelle	35 € x ud
Parrilla adicional intermedia	Extra middle shelf	Grille intermédiaire supplémentaire	20 € x set
Barras carniceras	Bars for meat set	Tube de boucher	135 € x set
Set 4 ruedas	4 Castors set	Jeu 4 roulettes	98 € x set
Set 6 ruedas	6 Castors set	Jeu 6 roulettes	146 € x set
Cerradura puerta inox	Stainless steel door lock	Serrure porte en inox	25 € x ud
Conexion WIFI o BT	WIFI or BT module	WIFI ou BT modulé	146 € x ud
Respaldo inox	Stainless steel rear side	Dos en acier inoxydable	consultar - consult - consulter
230V 60hz / 115v 60hz	230V 60hz / 115v 60hz	230V 60hz / 115v 60hz	consultar - consult - consulter

Características técnicas y constructivas sujetas a variación sin previo aviso. / We reserve the right to change specifications without prior notice. / Sujet technique et la conception de modifications sans préavis.



DASC-140-2

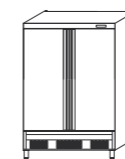

DASC-140-2 **5.054 €**
 DASCV-140-2 **6.092 €**

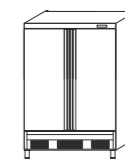

DASC-S-140 **4.190 €**
 DASC-ES-140-3 **5.930 €**

El proceso de **madurado en seco** es una técnica tradicional que da como resultado un producto superior con un perfil de sabor único para los carniceros expertos que buscan ofrecer un producto premium a sus clientes.

El proceso de envejecimiento en seco **requiere un espacio dedicado con temperatura y humedad controladas**, así como **equipo y usuario especializados**.

Cada experto tiene su propia experiencia y para eso, nuestros gabinetes profesionales les dan la oportunidad de ajustar el proceso.

Nuestra tecnología de maduración inteligente **simplifica el proceso** y le permite crear las **carnes más sabrosas**.

El proceso de maduración de la carne en seco se ha utilizado como una forma de conservar la carne. Se trata de mantener cortes enteros de carne en un **ambiente con temperatura y humedad controladas durante un período de tiempo**, lo que permite que las enzimas naturales actúen sobre los tejidos y grasa, **mejorando el sabor y la ternura de la carne**.

Este proceso suele durar **varias semanas**, durante las cuales **la carne pierde humedad**, lo que da como resultado un sabor más concentrado. **La temperatura y la humedad controladas** evitan el deterioro y el crecimiento de bacterias dañinas al mismo tiempo que permiten el desarrollo del **sabor natural de la carne**.

Gracias a las características que el madurado aporta a la carne, al final del proceso se obtiene un corte de carne más tierno y sabroso, con sabor único muy buscado y apreciado por los paladares que buscan una experiencia diferente.

Este resultado, sólo es posible uniendo la experiencia del carnicero experto con el mejor equipamiento profesional desarrollado para este particular proceso.



The **dry ageing process** is a time-honoured technique that results in a superior product with a unique flavour profile for butcher experts looking to offer a premium product to their customers.

The dry ageing process requires a **dedicated temperature and humidity-controlled space**, as well as **specialized user & equipment**.

Every expert has their own experience and for that, our professional cabinets let'em the chance to adjust the process.

Our smart ageing technology takes **the simple way out of the process**, allowing you to create the **tastiest meats**.

The dry ageing meat process has been used as a way to preserve meat. It involves hanging whole cuts of meat in a **temperature and humidity-controlled environment for a period of time**, allowing natural enzymes to break down the connective tissues and fat, **enhancing the flavour and tenderness of the meat**.

This process typically takes **several weeks**, during which **the meat loses moisture**, resulting in a more concentrated flavour. The controlled temperature and humidity prevent spoilage and the growth of harmful bacteria while allowing for the development of the **meat's natural flavour**.

The enzymes that break down the connective tissues and muscle fibres also break down the fat, resulting in a more tender and flavorful cut of meat. The meat also takes on a unique flavour that is highly sought after by meat connoisseurs. The resulting meat has superior flavour and tenderness which translates into a better experience for those who can offer dry-aged beef to their customers.



DDAV-200

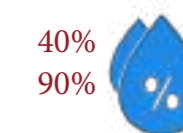

CARACTERÍSTICAS TÉCNICAS DDAV

Armarios expositores con temperatura de trabajo dentro del rango -2°+8°C y humedad entre 40% y 90% (sin aporte exterior de agua)
Garantizan el control y la seguridad del proceso de envejecimiento de la carne (maduración), con la posibilidad de monitorizar de forma remota o in situ el funcionamiento y ajustes de los equipos, gracias al avanzado sistema de control que incorporan

- Exterior en acero inox o plastificado negro, excepto el respaldo
- Interior en acero inox AISI-304, con aristas curvas y fondo embutido
- Puertas de apertura reversible, con sistema de cierre automático y burlete magnético (permanece abierta al superar los 90° de apertura), con marco aluminio anodizado y doble cristal con tratamiento bajo-emisivo (reduce condensación de humedad)
- Doble luz interior LED tonos rojos
- Estantes de acero AISI-304 y barras carniceras
- Bandeja y bloques de sal, opcionales
- Reguladores de altura delanteros y rodillos en la parte trasera para facilitar el desplazamiento
- Unidad condensadora ventilada
- Evaporador sistema tiro forzado, con recubrimiento epoxi anticorrosión y filtro de carbón activo
- Paro ventiladores tiro forzado al abrir la puerta
- Evaporación automática del agua de descarche
- Aislamiento de poliuretano inyectado, densidad 40 Kg/m³, cero ODP y GWP
- Control digital de temperatura y humedad, con eficiente gestión del consumo de energía y HACCP por conexión WIFI o BT (opcionales)

TECHNICAL DATA DDAV

Display cabinets with working temperature within the range -2°+ 8°C and humidity between 40% and 90% (without external water intake).
This guarantee control and safety of the meat aging process, with the possibility of remotely or on-site monitoring of the operation and adjustments of the equipment, thanks to the incorporated advanced control system

- AISI-304 stainless steel exterior or black coated, except rear side
- AISI-304 stainless steel interior, with curved edges and embedded bottom
- Reversible opening doors, with automatic closing system and magnetic weatherstripping (remains open when opening over 90°), with anodized aluminum frame and triple glass with low-emission treatment (reduces moisture condensation)
- Double LED interior light, soft pink
- SS shelves and meat bar
- Salt blocks and tray, on demnad
- Front height adjusters and rear rollers for easy movement
- Ventilated condensing unit
- Evaporator forced draft system, with anti-corrosion epoxy coating and carbon filter
- Forced draft fans stop when the door is opened
- Automatic evaporation of defrost water
- Injected polyurethane insulation, density 40 Kg / m³, zero ODP and GWP
- Digital temperature and humidity control, efficient management of energy consumption and HACCP by WIFI or BT module

CARACTÉRISTIQUES TECHNIQUES DDAV

Vitrines avec température de fonctionnement comprise entre -2°+8°C et humidité comprise entre 40% et 90% (sans alimentation en eau externe) Ils garantissent le contrôle et la sécurité du processus de vieillissement (maturation) de la viande, avec la possibilité de surveiller à distance ou sur place le fonctionnement et les réglages des équipements, grâce au système de contrôle avancé qu'ils intègrent.

- Extérieur en acier inoxydable ou revêtement plastique noir, sauf le dossier
- Intérieur en acier inoxydable AISI-304, avec bords incurvés et fond encastré
- Portes à ouverture réversible, avec système de fermeture automatique et coupe-vent magnétique (restent ouvertes lors de l'ouverture au-delà de 90°), avec cadre en aluminium anodisé et double vitrage avec traitement à faibles émissions (réduit la condensation de l'humidité)
- Double éclairage intérieur LED dans des tons rougeâtres
- Étagères et barres de boucherie en acier AISI-304
- Bac à sel et blocs, en option
- Régulateurs de hauteur à l'avant et roulettes à l'arrière pour faciliter le déplacement
- Unité de condensation ventilée
- Système d'évaporateur à tirage forcé, avec revêtement époxy anticorrosion et filtre à charbon actif
- Les ventilateurs à tirage forcé s'arrêtent à l'ouverture de la porte
- Évaporation automatique de l'eau de dégivrage
- Isolation en polyuréthane injecté, densité 40 Kg/m³, zéro ODP et GWP
- Contrôle numérique de la température et de l'humidité, avec gestion efficace de la consommation d'énergie et HACCP via connexion WIFI ou BT (en option)

Modelo	Largo	Alto	Fondo	Barras carniceras	Estantes	Volumen	Capacidad carne	Rango	Voltaje	Refrigerante	Potencia Frig.	Potencia	Clase clim.
Model	Length	Height	Depth	Butcher bars	Shelves	Capacity	Meat capacity	Range	Voltage	Refrigerant	Frig. Power	Power	Climatic Class
Modèle	Longueur	Hauteur	Profondeur	Barres de viande	Etagères	Volume	Capacité de viande	Rang	Tension	Réfrigérant	Puissance fri.	Puissance	Classe clim.
	mm	mm	mm	uds	uds	L	Kg	L			W	W	
DDAV-200	600	900	650	1	2	120	20	-2°C + 8°C	230V 50 Hz	R-600a	304	201	4 30°C 55%
DDAV-400	600	1545	650	1	2	240	55	-2°C + 8°C	230V 50 Hz	R-290	460	241	4 30°C 55%



DDAV-200-P



DDAV-400

PVP de opcionales incluidos en equipo, no como repuesto / PVP of options included in the equipment, not as a spare part / PVP d'options incluses dans l'équipement, pas en tant que pièce de rechange

OPCIONES - OPTIONS - OPTIONS

Módulo Bluetooth o Wifi (DDAV)	Bluetooth or Wifi set (DDAV)	Module Bluetooth ou Wifi (DDAV)	146 €
Estante adicional (DDAV)	Additional shelf (DDAV)	Etagere supplémentaire (DDAV)	61 € x ud
Barras carniceras (DDAV)	Bars for meat set (DDAV)	Tube de boucher (DDAV)	135 € x ud
Set 4 ruedas (DDAV)	4 Castors set (DDAV)	Jeu 4 roulettes (DDAV)	98 € x ud
Bandeja para 2 bloques sal (DDAV)	Tray for 2 salt blocks (DDAV)	Plateau pour 2 blocs de sel (DDAV)	72 € x ud
Bloque de sal 200x100x25mm	Salt block	blocs de sel	50 € x ud

Características técnicas y constructivas sujetas a variación sin previo aviso. / We reserve the right to change specifications without prior notice. / Sujet technique et la conception de modifications sans préavis.



DDAV-200 2.442 €

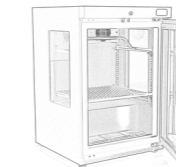

DDAV-200-P 3.036 €



DDAV-400 3.333 €

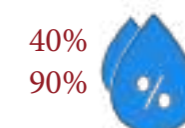
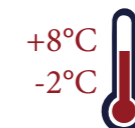

CARACTERÍSTICAS TÉCNICAS DDAV

- Armarios expositores con temperatura de trabajo dentro del rango -2°+8°C y humedad entre 40% y 90% (sin aporte exterior de agua)
- Garantizan el control y la seguridad del proceso de envejecimiento de la carne (maduración), con la posibilidad de monitorizar de forma remota o in situ el funcionamiento y ajustes de los equipos, gracias al avanzado sistema de control que incorporan
- Exterior en acero inox o plastificado negro, excepto el respaldo
- Interior en acero inox AISI-304, con aristas curvas y fondo embutido
- Puertas de apertura reversible, con sistema de cierre automático y burlete magnético (permanece abierta al superar los 90° de apertura), con marco aluminio anodizado y doble cristal con tratamiento bajo-emisivo (reduce condensación de humedad)
- Doble luz interior LED tonos rojos
- Estantes de acero AISI-304 y barras carniceras
- Bandeja y bloques de sal, opcionales
- Reguladores de altura delanteros y rodillos en la parte trasera para facilitar el desplazamiento
- Unidad condensadora ventilada
- Evaporador sistema tiro forzado, con recubrimiento epoxi anticorrosión y filtro de carbón activo
- Paro ventiladores tiro forzado al abrir la puerta
- Evaporación automática del agua de descarche
- Aislamiento de poliuretano inyectado, densidad 40 Kg/m³, cero ODP y GWP
- Control digital de temperatura y humedad, con eficiente gestión del consumo de energía y HACCP por conexión WIFI o BT (opcionales)

TECHNICAL DATA DDAV

Display cabinets with working temperature within the range -2°+ 8°C and humidity between 40% and 90% (without external water intake). This guarantee control and safety of the meat aging process, with the possibility of remotely or on-site monitoring of the operation and adjustments of the equipment, thanks to the incorporated advanced control system

- AISI-304 stainless steel exterior or black coated, except rear side
- AISI-304 stainless steel interior, with curved edges and embedded bottom
- Reversible opening doors, with automatic closing system and magnetic weatherstripping (remains open when opening over 90°), with anodized aluminum frame and triple glass with low-emission treatment (reduces moisture condensation)
- Double LED interior light, soft pink
- SS shelves and meat bar
- Salt blocks and tray, on demnd
- Front height adjusters and rear rollers for easy movement
- Ventilated condensing unit
- Evaporator forced draft system, with anti-corrosion epoxy coating and carbon filter
- Forced draft fans stop when the door is opened
- Automatic evaporation of defrost water
- Injected polyurethane insulation, density 40 Kg / m³, zero ODP and GWP
- Digital temperature and humidity control, efficient management of energy consumption and HACCP by WIFI or BT module

CARACTÉRISTIQUES TECHNIQUES DDAV

- Vitrines avec température de fonctionnement comprise entre -2°+ 8°C et humidité comprise entre 40% et 90% (sans alimentation en eau externe) Ils garantissent le contrôle et la sécurité du processus de vieillissement (maturation) de la viande, avec la possibilité de surveiller à distance ou sur place le fonctionnement et les réglages des équipements, grâce au système de contrôle avancé qu'ils intègrent.
- Extérieur en acier inoxydable ou revêtement plastique noir, sauf le dossier
- Intérieur en acier inoxydable AISI-304, avec bords incurvés et fond encastré
- Portes à ouverture réversible, avec système de fermeture automatique et coupe-vent magnétique (restent ouvertes lors de l'ouverture au-delà de 90°), avec cadre en aluminium anodisé et double vitrage avec traitement à faibles émissions (réduit la condensation de l'humidité)
- Double éclairage intérieur LED dans des tons rougeâtres
- Étagères et barres de boucherie en acier AISI-304
- Bac à sel et blocs, en option
- Régulateurs de hauteur à l'avant et roulettes à l'arrière pour faciliter le déplacement
- Unité de condensation ventilée
- Système d'évaporateur à tirage forcé, avec revêtement époxy anticorrosion et filtre à charbon actif
- Les ventilateurs à tirage forcé s'arrêtent à l'ouverture de la porte
- Évaporation automatique de l'eau de dégivrage
- Isolation en polyuréthane injecté, densité 40 Kg/m³, zéro ODP et GWP
- Contrôle numérique de la température et de l'humidité, avec gestion efficace de la consommation d'énergie et HACCP via connexion WIFI ou BT (en option)



Modelo	Largo	Alto	Fondo	Barras carniceras	Estantes	Volumen	Capacidad carne	Rango	Voltaje	Refrigerante	Potencia Frig.	Potencia	Clase clim.
Model	Length	Height	Depth	Butcher bars	Shelves	Capacity	Meat capacity	Range	Voltage	Refrigerant	Frig. Power	Power	Climatic Class
Modèle	Longueur	Hauteur	Profondeur	Barres de viande	Etagères	Volume	Capacité de viande	Rang	Tension	Réfrigérant	Puissance fri.	Puissance	Classe clim.
	mm	mm	mm	uds	uds	L	Kg.	L			W	W	
DDA-400	600	1900	650	1	2	320	75	-2°C + 8°C	230V 50 Hz	R-290	488	307	4 30°C 55%
DDA-750	680	2130	850	1	2	645	150	-2°C + 8°C	230V 50 Hz	R-290	502	307	4 30°C 55%
DDA-1002	1370	2130	850	2	4	1404	300	-2°C + 8°C	230V 50 Hz	R-290	1000	620	4 30°C 55%
DDA-2003	2055	2130	850	3	6	2197	450	-2°C + 8°C	230V 50 Hz	R-290	1710	1100	4 30°C 55%

PVP de opcionales incluidos en equipo, no como repuesto / PVP of options included in the equipment, not as a spare part / PVP d'options incluses dans l'équipement, pas en tant que pièce de rechange

OPCIONES - OPTIONS - OPTIONS

Módulo Bluetooth o Wifi	Bluetooth or Wifi set	Module Bluetooth ou Wifi	146 € x ud
Estante adicional DDA-400	Additional shelf DDA-400	Etagere supplémentaire DDA-400	61 € x ud
Estante adicional DDA-750/1002/2003	Additional shelf DDA-750/1002/2003	Etagere supplémentaire DDA-750/1002/2003	89 € x ud
Barras carniceras adicionales	Additional bars for meat	Tube de boucherie adicional	135 € x ud
Set 4 ruedas	4 Castors set	Jeu 4 roulettes	98 € x ud
Set 6 ruedas	6 Castors set	Jeu 6 roulettes	148 € x ud
Bandeja para 3 bloques sal	Tray for 3 salt blocks	Plateau pour 3 blocs de sel	90 € x ud
Bloque de sal 200x100x25mm	Salt block	blocs de sel	50 € x ud
Bandeja + bloques de sal 200x100x25mm	Tray + salt blocks 200x100x25mm	Plateau + blocs de sel 200x100x25mm	240 € x ud
Filtro carbón activo	Activated carbon filter	Filtre à charbon actif	consultar - consult - consulter
230V 60hz / 115v 60hz	230V 60hz / 115v 60hz	230V 60hz / 115v 60hz	consultar - consult - consulter

Características técnicas y constructivas sujetas a variación sin previo aviso. / We reserve the right to change specifications whitout prior notice. / Sujet technique et la conception de modifications sans préavis.



DDA-400-I



DDA-750



DDA-400 3.700 €



DDA-750 4.028 €



DDA-1002 6.346 €



DDA-2003 9.963 €

8 ABATIDORES CABINET ARMOIRES



CARACTERÍSTICAS TÉCNICAS

- Exterior en acero inox AISI-304 18/10, excepto el respaldo
- Interior en acero inox AISI-304 18/10, con aristas curvas y fondo embutido
- Puertas de apertura reversible, con sistema de cierre automático y burlete magnético (permanece abierta al superar los 90° de apertura)
- Contrapuerta inox embutida
- Luz interior
- Estantes interiores de varilla en acero plastificado, regulables en altura
- Pies en tubo de acero inox ajustables en altura 125-200 mm
- Cuadro de mandos y rejilla ventilación motor, desmontables
- Unidad condensadora ventilada
- Evaporador sistema tiro forzado, con recubrimiento anticorrosión
- Paro ventiladores tiro forzado al abrir la puerta
- Evaporación automática del agua de descarche
- Aislamiento de poliuretano inyectado, densidad 40 Kg/m³, bajo GWP y cero efecto ODP
- Control digital de temperatura y descarches, eficiente en la gestión del consumo de energía
- Temperatura de trabajo a 32°C ambiente

TECHNICAL DATA

- AISI-304 18/10 stainless steel exterior, except the rear side
- AISI-304 18/10 stainless steel interior, stamped bottom and rounded corners
- Doors with self closing system, blocked opening, magnetic gasket and possibility of changing the opening sense
- Rear-door by stamped steel
- Interior lighting
- Shelves made of plasticized steel wire, height adjustable
- AISI-304 18/10 adjustable legs, 125 to 200 mm
- Control panel and engine ventilation grill, removable
- Fan assisted condenser unit
- Fan assisted evaporator, with anticorrosion coating
- Evaporator fan stops when door is opened
- Automatic evaporation of defrost water
- 40 Kg/m³ density polyurethane insulation, low GWP and zero ODP effect
- Energy efficient digital controller of temperature and defrosts
- Operating temperature 32°C ambient

CARACTÉRISTIQUES TECHNIQUES

- Extérieur en acier inox AISI 304 18/10, à l'exception de la partie arrière
- Intérieur en acier inox AISI 304 18/10, avec bords incurvés et bac encastré.
- Ouverture des portes réversibles avec système de fermeture automatique avec joint magnétique (la porte se maintient ouverte lorsque l'angle dépasse les 90° à l'ouverture)
- Contreporte en Inox encastrée
- Lumière intérieure
- Étagères intérieures avec Fils d'acier plastifiés, réglables en hauteur.
- PIEDS en tube d'acier inoxydable réglables en hauteur 125 - 200 mm
- Tableau de bord et grille de ventilation du moteur amovibles
- Unité de condensation ventilée
- Evaporateurs avec système de marche forcée et recouvrement anticorrosion.
- Arrêt automatique des ventilateurs et du système de marche forcée à l'ouverture de la porte.
- Evaporation automatique des eaux de dégivrage.
- Isolation à base de polyuréthane injecté, densité 40 kg / m³, faible GWP et aucun effet ODP.
- Le Contrôle digital de température ainsi que le dégivrage automatique œuvre à une meilleure gestion de la consommation énergétique.
- Température ambiante de travail à 32°C



DA3N Página 361
Abatidor temperatura 3 niveles
3 levels blast chiller
Cellule de refroidissement rapide à 3 niveaux



DA5N Página 363
Abatidor temperatura 5 niveles
5 levels blast chiller
Cellule de refroidissement rapide à 5 niveaux



DA7N Página 365
Abatidor temperatura 7 niveles
7 levels blast chiller
Cellule de refroidissement rapide à 7 niveaux



DA10N Página 367
Abatidor temperatura 10 niveles
10 levels blast chiller
Cellule de refroidissement rapide à 10 niveaux



DA15N Página 369
Abatidor temperatura 15 niveles
15 levels blast chiller
Cellule de refroidissement rapide à 15 niveaux



DAN-S Página 371
Abatidores de temperatura
Blast chillers
Cellules de refroidissement rapide

¿Qué es un abatidor?

Un abatidor es un equipo que baja rápidamente la temperatura de los alimentos. Los abatidores rápidos también se conocen como congeladores rápidos o ultracongeladores. Por lo general, tienen varios estantes donde las bandejas de alimentos o las bandejas de hojas se pueden almacenar y refrigerar a temperaturas extremadamente bajas.

¿Cómo funciona un abatidor?

Los abatidores funcionan aplicando aire enfriado a presión sobre los alimentos colocados en el interior. Este proceso de enfriamiento rápido (abatimiento) disminuye el tamaño de los cristales de hielo que aparecen en los alimentos. Al descongelar alimentos, los cristales de hielo grandes se derriten y hacen que se libere el exceso de humedad, lo que afecta al sabor y calidad.

¿Cuánto tiempo tarda un abatidor en enfriar los alimentos?

El objetivo de un abatidor es enfriar los alimentos a un ritmo rápido. Por lo general, pueden reducir la temperatura de los alimentos de +90°C a +3°C (abatimiento positivo) en menos de 90 minutos o de +90°C a -18°C (abatimiento negativo) aproximadamente 180 minutos. Esto depende de la temperatura de los alimentos, del ajuste del abatidor y de si está congelando los alimentos o simplemente enfriándolos.

What is a Blast Chiller?

A blast chiller is a piece of equipment that quickly lowers the temperature of food. Blast chillers are also referred to as blast freezers or flash freezers. They typically have multiple shelves where food pans or sheet pans can be stored and chilled at extremely low temperatures.

How Does a Blast Chiller Work?

Blast chillers or freezers operate by blowing forced cooled air over food placed inside. This rapid cooling process decreases the size of ice crystals that appear on food. When defrosting food, large ice crystals melt and cause excess moisture to release, which largely impacts the taste and quality of your food products.

How Long Does a Blast Chiller Take to Chill Food?

The goal of a blast chiller is to chill foods at a rapid rate. They can typically bring the temperature of foods down from +90°C to +3°C (blast chilling) in less than 90 minutes or from +90°C to -18°C (blast freezing) about 180 minutes. This is dependent on the temperature of the food, blast chiller setting, and whether you are freezing your food or simply cooling it.

INTERFAZ DE PANTALLA GRÁFICA TÁCTIL

Incorporamos interfaz táctil con pantalla de 5" que permite un uso sencillo e intuitivo del abatidor, adaptada a las necesidades de los chefs más exigentes. Iconos intuitivos facilitan el acceso a las numerosas funciones para una gestión óptima de cada proceso. Cada ciclo es personalizable para conseguir el proceso ideal para cada alimento.

GRAPHIC TOUCH SCREEN INTERFACE

We incorporate a touch interface with a 5" screen that allows a simple and intuitive use of the blast chiller, adapted to the needs of the most demanding chefs. Intuitive icons facilitate access to the numerous functions for optimal management of each process. Each cycle is customizable to achieve the ideal process for each food.



CICLOS DE ENFRIAMIENTO Y CONGELACIÓN RÁPIDA

Enfrían a +3°C y congelan a -18°C, manteniendo la consistencia, humedad y propiedades nutritivas, reduciendo el tamaño de los microcristales en la estructura interna de los alimentos.

QUICK FREEZING AND COOLING CYCLES

Cooling to +3°C and freezing at -18°C, preserving consistency, humidity and nutritional properties, reducing the size of the microcrystals in the internal structure of the food.

DESCONGELACIÓN ALIMENTOS

Controlan el proceso de descongelación y programar la temperatura correcta significa ralentizar el proceso de proliferación bacteriana y mantener intacta la estructura de los alimentos.

DEFROSTING FOOD

Controlling the defrosting process and setting the correct temperature means slowing down the bacterial growth process and keeping the food structure intact.

CICLO MANTENIMIENTO TEMPERATURA

Mantiene el alimento a la temperatura programada, positiva o negativa.

TEMPERATURE MAINTENANCE CYCLE

It keeps the food at the programmed temperature, positive or negative.

ENDURECIMIENTO DE HELADO

Congela rápidamente la mezcla recién batida a -18°C en el núcleo, favoreciendo la formación de cristales finos y regulares para un helado homogéneo

ICE CREAM HARDENING

Quickly freezes the freshly beaten mixture at -18°C in the core, favoring the formation of fine and regular crystals for a homogeneous ice cream

PRE-ENFRIAMIENTO

Antes de operar con el abatidor ciclos de refrigeración o congelación, con el pre-enfriamiento se consigue atemperar el habitáculo interior para mejor rendimiento del proceso

PRE-COOLING

Before operating with the blast chiller cooling or freezing cycles, with pre-cooling it is possible to temper the interior compartment for better process performance

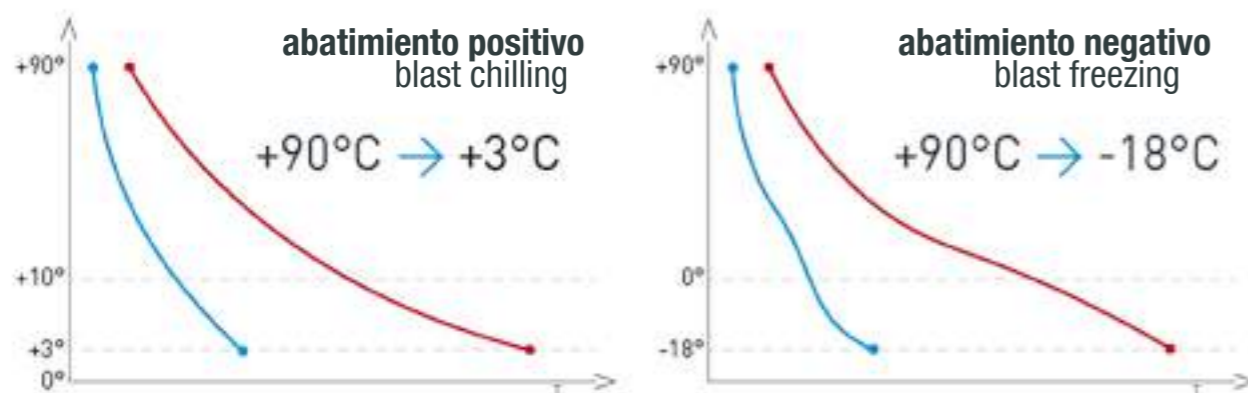

Evitar la zona de peligro de temperatura

Las bacterias se multiplican a un ritmo rápido a temperaturas altas. Mantener los alimentos en la zona de peligro de temperatura durante un período prolongado aumenta las posibilidades de contraer enfermedades transmitidas por los alimentos. Los abatidores rápidos bajan la temperatura de los alimentos a un ritmo rápido y los protegen de la zona de peligro.

Avoiding the Temperature Danger Zone

Bacteria multiply at a rapid pace on high temperatures. Keeping food in the temperature danger zone for an extended amount of time increases the chances of foodborne illness. Blast chillers lower the temperatures of food at a rapid pace and protect food from the danger zone.

NO proliferación de bacterias

NO bacterial proliferation

Empieza la proliferación de bacterias

Bacterial proliferation starts

Máxima proliferación de bacterias

Maximum bacterial proliferation

Mínima proliferación de bacterias

Minimum bacterial proliferation

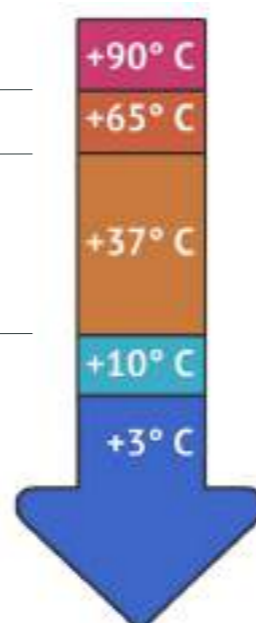

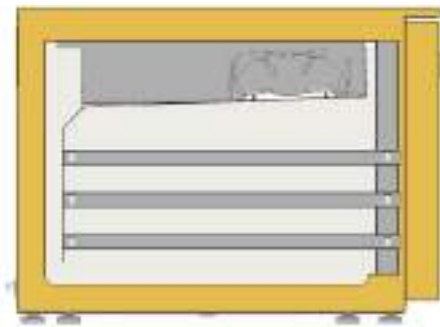

GN 1/1 - 40

DA3N



CARACTERÍSTICAS TÉCNICAS

TECHNICAL DATA

CARACTÉRISTIQUES TECHNIQUES

- Exterior en acero inox AISI-304, excepto el respaldo
- Interior en acero inox AISI-304
- Puertas con sistema de cierre automático y burlete magnético (permanece abierta al superar los 90° de apertura)
- Microrruptor apertura de puerta inductivo
- Encimera de acero inox AISI-304
- Capacidad interior GN1/1 (cubetas no incluidas)
- 70 mm paso entre niveles
- Unidad condensadora ventilada
- Evaporador sistema tiro forzado, con recubrimiento epoxi anticorrosión
- Válvula de expansión
- Aislamiento de poliuretano inyectado, densidad 40 Kg/m³
- Panel de control gráfico con pantalla táctil TFT de 5 pulgadas, IP65
- Gestión avanzada de las funciones para abatidores de temperatura de última generación.
- Conectividad RS-485 y USB
- Sonda de pincho desmontable y calefactada, incluida
- Gestión de ciclos por tiempo o temperatura
- Test de correcta inserción de sonda (gestión por temperatura)
- Grabación de datos HACCP, visualizables en pantalla o descargables por puerto USB en formato CSV
- Ciclos de abatimiento y congelación "hard/soft"
- 4 combinaciones de ciclos estándar de abatimiento
- Programación de ciclo continuo por temperatura o tiempo
- Múltiples programas personalizables
- Descarche por resistencia al inicio de ciclo, optimizado por temperatura
- Eficiente gestión del consumo de energía

- AISI-304 stainless steel exterior, except the rear side
- Interior in AISI-304 stainless steel
- Doors with automatic closing system and magnetic gasket (stays open when opening over 90 °)
- Inductive door opening microswitch
- AISI-304 stainless steel top
- GN1/1 and inner capacity (trays not included)
- 70 mm distance between levels
- Ventilated condensing unit
- Forzed air evaporator system with anti-corrosion epoxy coating
- Expansion valve
- Injected polyurethane insulation, density 40 Kg/m³
- Graphical control panel with 5 inches TFT touch screen, IP65
- Advanced management of the functions for the latest generation blast chillers.
- RS-485 and USB connectivity
- Included detachable and heated core probe
- Management of cycles by time or temperature
- Probe insertion test (temperature management)
- Recording of HACCP data, viewable on screen or downloadable via USB port in CSV format
- Chilling and freezing cycles "hard / soft"
- 4 blast chillig standard cycle combinations
- Continuous cycle programming by temperature or time
- Multiple customizable programs
- Defrost by resistance at the beginning of the cycle, optimized by temperature
- Efficient management of energy consumption

- Extérieur en acier inoxydable AISI-304, sauf le dos
- Intérieur en acier inoxydable AISI-304
- Portes avec système de fermeture automatique et coupe-froid magnétique (reste ouvert lors d'une ouverture à plus de 90 °)
- Microrrupteur d'ouverture de porte inductif
- Plateau en acier inoxydable AISI-304
- Capacité intérieure GN1 / 1 (godets non inclus)
- Pas de 70 mm entre les niveaux
- Unité de condensation ventilée
- Système de tirage forcé de l'évaporateur, avec revêtement époxy anticorrosion
- Soupape de détente
- Isolation polyuréthane injecté, densité 40 Kg / m³
- Panneau de commande graphique avec écran tactile TFT 5 pouces, IP65
- Gestion avancée des fonctions des cellules de refroidissement rapide de dernière génération.
- Connectivité RS-485 et USB
- Sonde à pointe amovible et chauffée, incluse
- Gestion des cycles par temps ou température
- Test d'insertion de sonde (gestion de la température)
- Enregistrement des données HACCP, visualisables à l'écran ou téléchargeables via le port USB au format CSV
- Cycles de refroidissement et de congélation "dur / doux"
- 4 combinaisons de cycles de refroidissement rapide standard
- Programmation du cycle continu par température ou temps
- Plusieurs programmes personnalisables
- Dégivrage par résistance en début de cycle, optimisé par température
- Gestion efficace de la consommation d'énergie



Modelo	Largo	Alto	Fondo	Aislamiento	Capacidad	Pares guias	Volumen	Ciclo sonda	Ciclo tiempo	Duración	Duración	Voltaje	Refrigerante	Potencia Frig.	Potencia	Producción	Producción	Clase clim.
Model	Length	Height	Depth	Insulation	Capacity	Sets slides	Capacity	Probe Cycle	Time Cycle	Time	Time	Voltage	Refrigerant	Frig. Power	power	Production	Production	Climatic Class
Modèle	Longueur	Hauteur	Profondeur	Isolement	Exposition	Kit guides	Volume	Cycle sonde	Cycle temps	Durée	Durée	Tension	Réfrigérant	Puissance fri.	Puissance	Production	Production	Classe clim.
	mm	mm	mm	mm	GN 1/1-40		L	L	L	+90/ +3min	+90/ -18min			W	W	+90/ +3 kg.	+90/ -18 kg.	
DA3N	715	520	700	45	3	3	42	Si / Yes / Oui	Si / Yes / Oui	120	270	1N 230V 50 Hz	R-290	694	1100	10	6.8	5 40°C 40%



- **Opcional:** interfaz WIFI permite visualizar alarmas, estados de la máquina, historial HACCP y acceder a operaciones de configuración desde PC, smartphone o tableta

- **Optional:** WIFI interface to visualize alarms, machine statuses, HACCP history and let access configuration operations from PC, smartphone, or tablet

- **En option:** l'interface WIFI vous permet de visualiser les alarmes, les états de la machine, l'historique HACCP et d'accéder aux opérations de configuration depuis un PC, un smartphone ou une tablette

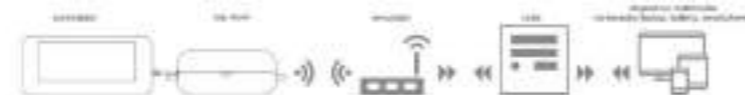

DA3N 4.138 €

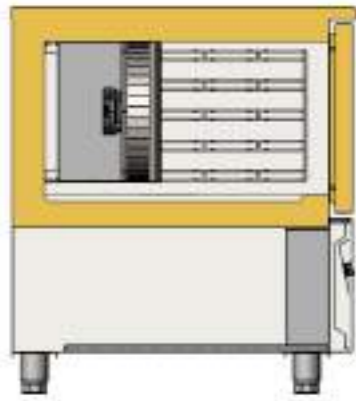

Sonda de pincho calefactada desmontable, incluida en todos los modelos
Detachable heatedcore probe, included in all models
Sonde à pointe chauffante amovible, incluse dans tous les modèles



GN 1/1 - 40

DA5N



CARACTERÍSTICAS TÉCNICAS

TECHNICAL DATA

CARACTÉRISTIQUES TECHNIQUES

- Exterior en acero inox AISI-304, excepto el respaldo
- Interior en acero inox AISI-304
- Puertas con sistema de cierre automático y burlete magnético (permanece abierta al superar los 90° de apertura)
- Microrruptor apertura de puerta inductivo
- Encimera de acero inox AISI-304
- Capacidad interior combinada GN1/1 y 60x40 (cubetas o bandejas no incluidas)
- Unidad condensadora ventilada
- Evaporador sistema tiro forzado, con recubrimiento epoxi anticorrosión
- Válvula de expansión
- Aislamiento de poliuretano inyectado, densidad 40 Kg/m³
- Panel de control gráfico con pantalla táctil TFT de 5 pulgadas, IP65
- Gestión avanzada de las funciones para abatidores de temperatura de última generación.
- Conectividad RS-485 y USB
- Sonda de pincho desmontable y calefactada, incluida
- Gestión de ciclos por tiempo o temperatura
- Test de correcta inserción de sonda (gestión por temperatura)
- Grabación de datos HACCP, visualizables en pantalla o descargables por puerto USB en formato CSV
- Ciclos de abatimiento y congelación "hard/soft"
- 4 combinaciones de ciclos estándar de abatimiento
- Programación de ciclo continuo por temperatura o tiempo
- Múltiples programas personalizables
- Descarche por resistencia al inicio de ciclo, optimizado por temperatura
- Eficiente gestión del consumo de energía

- AISI-304 stainless steel exterior, except the rear side
- Interior in AISI-304 stainless steel
- Doors with automatic closing system and magnetic gasket (stays open when opening over 90 °)
- Inductive door opening microswitch
- AISI-304 stainless steel top
- GN1/1 and 60x40 combined inner capacity (trays od shelves not included)
- Ventilated condensing unit
- Forzed air evaporator system with anti-corrosion epoxy coating
- Expansion valve
- Injected polyurethane insulation, density 40 Kg/m³
- Graphical control panel with 5 inches TFT touch screen, IP65
- Advanced management of the functions for the latest generation blast chillers.
- RS-485 and USB connectivity
- Included detachable and heated core probe
- Management of cycles by time or temperature
- Probe insertion test (temperature management)
- Recording of HACCP data, viewable on screen or downloadable via USB port in CSV format
- Chilling and freezing cycles "hard / soft"
- 4 blast chillig standard cycle combinations
- Continuous cycle programming by temperature or time
- Multiple customizable programs
- Defrost by resistance at the beginning of the cycle, optimized by temperature
- Efficient management of energy consumption

- Extérieur en acier inoxydable AISI-304, sauf le dos
- Intérieur en acier inoxydable AISI-304
- Portes avec système de fermeture automatique et coupe-froid magnétique (reste ouvert lors d'une ouverture à plus de 90 °)
- Microrrupteur d'ouverture de porte inductif
- Plateau en acier inoxydable AISI-304
- Capacité intérieure combinée GN1 / 1 et 60x40 (seaux ou plateaux non inclus)
- Unité de condensation ventilée
- Système de tirage forcé de l'évaporateur, avec revêtement époxy anticorrosion
- Soupape de détente
- Isolation polyuréthane injecté, densité 40 Kg / m³
- Panneau de commande graphique avec écran tactile TFT 5 pouces, IP65
- Gestion avancée des fonctions des cellules de refroidissement rapide de dernière génération.
- Connectivité RS-485 et USB
- Sonde à pointe amovible et chauffée, incluse
- Gestion des cycles par temps ou température
- Test d'insertion de sonde (gestion de la température)
- Enregistrement des données HACCP, visualisables à l'écran ou téléchargeables via le port USB au format CSV
- Cycles de refroidissement et de congélation "dur / doux"
- 4 combinaisons de cycles de refroidissement rapide standard
- Programmation du cycle continu par température ou temps
- Plusieurs programmes personnalisables
- Dégivrage par résistance en début de cycle, optimisé par température
- Gestion efficace de la consommation d'énergie



Modelo	Largo	Alto	Fondo	Aislamiento	Capacidad	Capacidad	Volumen	Ciclo sonda	Ciclo tiempo	Duración	Duración	Voltaje	Refrigerante	Potencia Frig.	Potencia	Producción	Producción	Clase clim.
Model	Length	Height	Depth	Insulation	Capacity	Capacity	Capacity	Probe Cycle	Time Cycle	Time	Time	Voltage	Refrigerant	Frig. Power	Power	Production	Production	Climatic Class
Modèle	Longueur	Hauteur	Profondeur	Isolement	Exposition	Exposition	Volume	Cycle sonde	Cycle temps	Duréé	Duréé	Tension	Réfrigérant	Puissance fri.	Puissance	Production	Production	Classe clim.
	mm	mm	mm	mm	GN 1/1-40	60 X 40	L	L	L	+90/ +3min	+90/ -18min			W	W	+90/ +3 kg.	+90/ -18 kg.	
DA5N	800	900	800	60	5	4	85	Si / Yes / Oui	Si / Yes / Oui	120	270	1N 230V 50 Hz	R-290	907	990	23	14	5 40°C 40%



- **Opcional:** interfaz WIFI permite visualizar alarmas, estados de la máquina, historial HACCP y acceder a operaciones de configuración desde PC, smartphone o tableta

- **Optional:** WIFI interface to visualize alarms, machine statuses, HACCP history and let access configuration operations from PC, smartphone, or tablet

- **En option:** l'interface WIFI vous permet de visualiser les alarmes, les états de la machine, l'historique HACCP et d'accéder aux opérations de configuration depuis un PC, un smartphone ou une tablette

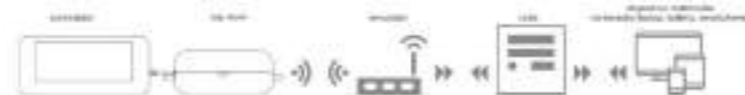

DA5N 5.314 €

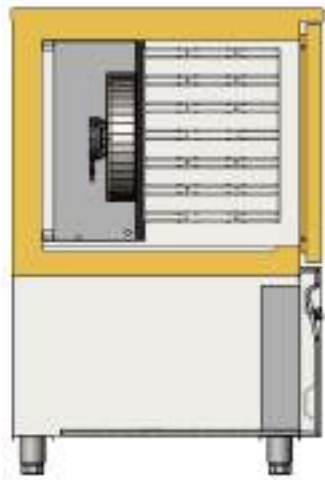

DA7N



DA7N-H



Capacidad interior combinada GN1/1 y 60x40
GN1/1 and 60x40 combined inner capacity
Capacité intérieure combinée GN1 / 1 et 60x40



GN 1/1 - 40

DA7N



DA7N



DA7N-H



DA7N-H

CARACTERÍSTICAS TÉCNICAS

- Exterior en acero inox AISI-304, excepto el respaldo
- Interior en acero inox AISI-304
- Puertas con sistema de cierre automático y burlete magnético (permanece abierta al superar los 90° de apertura)
- Microrruptor apertura de puerta inductivo
- Encimera de acero inox AISI-304
- Capacidad interior combinada GN1/1 y 60x40 (cubetas o bandejas no incluidas)
- Unidad condensadora ventilada
- Evaporador sistema tiro forzado, con recubrimiento epoxi anticorrosión
- Válvula de expansión
- Aislamiento de poliuretano inyectado, densidad 40 Kg/m³
- Panel de control gráfico con pantalla táctil TFT de 5 pulgadas, IP65
- Gestión avanzada de las funciones para abatidores de temperatura de última generación.
- Conectividad RS-485 y USB
- Sonda de pincho desmontable y calefactada, incluida
- Gestión de ciclos por tiempo o temperatura
- Test de correcta inserción de sonda (gestión por temperatura)
- Grabación de datos HACCP, visualizables en pantalla o descargables por puerto USB en formato CSV
- Ciclos de abatimiento y congelación "hard/soft"
- 4 combinaciones de ciclos estándar de abatimiento
- Programación de ciclo continuo por temperatura o tiempo
- Múltiples programas personalizables
- Descarce por resistencia al inicio de ciclo, optimizado por temperatura
- Eficiente gestión del consumo de energía

TECHNICAL DATA

- AISI-304 stainless steel exterior, except the rear side
- Interior in AISI-304 stainless steel
- Doors with automatic closing system and magnetic gasket (stays open when opening over 90°)
- Inductive door opening microswitch
- AISI-304 stainless steel top
- GN1/1 and 60x40 combined inner capacity (trays or shelves not included)
- Ventilated condensing unit
- Forced air evaporator system with anti-corrosion epoxy coating
- Expansion valve
- Injected polyurethane insulation, density 40 Kg/m³
- Graphical control panel with 5 inches TFT touch screen, IP65
- Advanced management of the functions for the latest generation blast chillers.
- RS-485 and USB connectivity
- Included detachable and heated core probe
- Management of cycles by time or temperature
- Probe insertion test (temperature management)
- Recording of HACCP data, viewable on screen or downloadable via USB port in CSV format
- Chilling and freezing cycles "hard / soft"
- 4 blast chilling standard cycle combinations
- Continuous cycle programming by temperature or time
- Multiple customizable programs
- Defrost by resistance at the beginning of the cycle, optimized by temperature
- Efficient management of energy consumption

CARACTÉRISTIQUES TECHNIQUES

- Extérieur en acier inoxydable AISI-304, sauf le dos
- Intérieur en acier inoxydable AISI-304
- Portes avec système de fermeture automatique et coupe-froid magnétique (reste ouvert lors d'une ouverture à plus de 90°)
- Microrrupteur d'ouverture de porte inductif
- Plateau en acier inoxydable AISI-304
- Capacité intérieure combinée GN1 / 1 et 60x40 (seaux ou plateaux non inclus)
- Unité de condensation ventilée
- Système de tirage forcé de l'évaporateur, avec revêtement époxy anticorrosion
- Soupape de détente
- Isolation polyuréthane injecté, densité 40 Kg / m³
- Panneau de commande graphique avec écran tactile TFT 5 pouces, IP65
- Gestion avancée des fonctions des cellules de refroidissement rapide de dernière génération.
- Connectivité RS-485 et USB
- Sonde à pointe amovible et chauffée, incluse
- Gestion des cycles par temps ou température
- Test d'insertion de sonde (gestion de la température)
- Enregistrement des données HACCP, visualisables à l'écran ou téléchargeables via le port USB au format CSV
- Cycles de refroidissement et de congélation "dur / doux"
- 4 combinaisons de cycles de refroidissement rapide standard
- Programmation du cycle continu par température ou temps
- Plusieurs programmes personnalisables
- Dégivrage par résistance en début de cycle, optimisé par température
- Gestion efficace de la consommation d'énergie



Modelo Model Modèle	Largo Length Longueur	Alto Height Hauteur	Fondo Depth Profond.	Aislamiento Insulation Isolément	Capacidad Capacity Capacité	Capacidad Capacity Capacité	Volumen Capacity Volume	Ciclo sonda Probe Cycle Cycle sonde	Ciclo tiempo Time Cycle Cycle temps	Duración Time Durée	Duración Time Durée	Voltaje Voltage Tension	Refrigerante Refrigerant Réfrigérant	Potencia Frig. Frig. Power Puissance fri.	Potencia Power Puissance	Producción Production Production	Producción Production Production	Clase clim. Climatic Class Classe clim.
	mm	mm	mm	mm	GN 1/1-40	60 X 40	L	L	L	Durée +90/ +3min	Durée +90/ -18min	V	R-290	W	W	Production +90/ +3 kg.	Production +90/ -18 kg.	
DA7N	800	1240	800	60	7	7	118	Si / Yes / Oui	Si / Yes / Oui	120	270	1N 230V 50 Hz	R-290	1309	1150	30	20	5 40°C 40%
DA7N-H	1350	850	700	60	7	-	118	Si / Yes / Oui	Si / Yes / Oui	120	270	1N 230V 50 Hz	R-290	1309	1150	30	20	5 40°C 40%



- **Opcional:** interfaz WIFI permite visualizar alarmas, estados de la máquina, historial HACCP y acceder a operaciones de configuración desde PC, smartphone o tableta

- **Optional:** WIFI interface to visualize alarms, machine statuses, HACCP history and let access configuration operations from PC, smartphone, or tablet

- **En option:** l'interface WIFI vous permet de visualiser les alarmes, les états de la machine, l'historique HACCP et d'accéder aux opérations de configuration depuis un PC, un smartphone ou une tablette



Características técnicas y constructivas sujetas a variación sin previo aviso. / We reserve the right to change specifications without prior notice. / Sujet technique et la conception de modifications sans préavis.

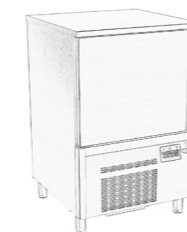

DA7N **5.761 €**



DA7N-H **6.775 €**



DA10N



Capacidad interior combinada GN1/1 y 60x40
 GN1/1 and 60x40 combined inner capacity
 Capacité intérieure combinée GN1 / 1 et 60x40

CARACTERÍSTICAS TÉCNICAS	TECHNICAL DATA	CARACTÉRISTIQUES TECHNIQUES
<ul style="list-style-type: none"> Exterior en acero inox AISI-304, excepto el respaldo Interior en acero inox AISI-304 Puertas con sistema de cierre automático y burlete magnético (permanece abierta al superar los 90° de apertura) Microrruptor apertura de puerta inductivo Encimera de acero inox AISI-304 Capacidad interior combinada GN1/1 y 60x40 (cubetas o bandejas no incluidas) Unidad condensadora ventilada Evaporador sistema tiro forzado, con recubrimiento epoxi anticorrosión Válvula de expansión Aislamiento de poliuretano inyectado, densidad 40 Kg/m³ Panel de control gráfico con pantalla táctil TFT de 5 pulgadas, IP65 Gestión avanzada de las funciones para abatidores de temperatura de última generación. Conectividad RS-485 y USB Sonda de pincho desmontable y calefactada, incluida Test de ciclos por tiempo o temperatura Test de correcta inserción de sonda (gestión por temperatura) Grabación de datos HACCP, visualizables en pantalla o descargables por puerto USB en formato CSV Ciclos de abatimiento y congelación "hard/soft" 4 combinaciones de ciclos estándar de abatimiento Programación de ciclo continuo por temperatura o tiempo Múltiples programas personalizables Descarce por resistencia al inicio de ciclo, optimizado por temperatura Eficiente gestión del consumo de energía 	<ul style="list-style-type: none"> AISI-304 stainless steel exterior, except the rear side Interior in AISI-304 stainless steel Doors with automatic closing system and magnetic gasket (stays open when opening over 90 °) Inductive door opening microswitch AISI-304 stainless steel top GN1/1 and 60x40 combined inner capacity (trays or shelves not included) Ventilated condensing unit Forced air evaporator system with anti-corrosion epoxy coating Expansion valve Injected polyurethane insulation, density 40 Kg/m³ Graphical control panel with 5 inches TFT touch screen, IP65 Advanced management of the functions for the latest generation blast chillers. RS-485 and USB connectivity Included detachable and heated core probe Management of cycles by time or temperature Probe insertion test (temperature management) Recording of HACCP data, viewable on screen or downloadable via USB port in CSV format Chilling and freezing cycles "hard / soft" 4 blast chilling standard cycle combinations Continuous cycle programming by temperature or time Multiple customizable programs Defrost by resistance at the beginning of the cycle, optimized by temperature Efficient management of energy consumption 	<ul style="list-style-type: none"> Extérieur en acier inoxydable AISI-304, sauf le dossier. Intérieur en acier inoxydable AISI-304. Portes avec système de fermeture automatique et coupe-froid magnétique (restent ouvertes lors d'une ouverture à plus de 90°) Micro-interrupteur d'ouverture de porte inductif Dessus en acier inoxydable AISI-304 Capacité intérieure combinée GN1/1 et 60x40 (seaux ou plateaux non inclus) Groupe de condensation ventilé Système à tirage forcé de l'évaporateur, avec revêtement époxy anti-corrosion. Soupape de détente Isolation en polyuréthane injecté, densité 40 Kg/m³ Panneau de contrôle graphique avec écran tactile TFT 5 pouces, IP65 Gestion avancée des fonctions des cellules de refroidissement rapide de dernière génération. Connectivité RS-485 et USB Sonde à pointe amovible et chauffée, incluse Gestion des cycles par temps ou température Test d'insertion de la sonde (gestion de la température) Enregistrement des données HACCP, visualisables à l'écran ou téléchargeables via port USB au format CSV Cycles de refroidissement et de congélation "hard/soft" 4 combinaisons de cycles de refroidissement rapide standard Programmation du cycle continu par température ou temps Plusieurs programmes personnalisables Dégivrage par résistance en début de cycle, optimisé par la température Gestion efficace de la consommation d'énergie

Modelo	Largo	Alto	Fondo	Aislamiento	Capacidad	Capacidad	Ciclo sonda	Ciclo tiempo	Duración	Duración	Voltaje	Refrigerante	Potencia Frig.	Potencia	Producción	Producción	Clase clim.
Model	Length	Height	Depth	Insulation	Capacity	Capacity	Probe Cycle	Time Cycle	Time	Time	Voltage	Refrigerant	Frig. Power	Power	Production	Production	Climatic Class
Modèle	Longueur	Hauteur	Profond.	Isolément	Exposition	Exposition	Cycle sonde	Cycle temps	Duréé	Duréé	Tension	Réfrigérant	Puissance fri.	Puissance	Production	Production	Classe clim.
	mm	mm	mm	mm	GN 1/1-40	60 X 40	L	L	+90/ +3min	+90/ -18min			W	W	+90/ +3 kg.	+90/ -18 kg.	
DA10N	800	1590	800	60	10	10	Si / Yes / Oui	Si / Yes / Oui	120	270	1N 230V 50 Hz	*R-452A	2130	2080	42	33	5 40°C 40%

*Versión R-290, consultar - ask for R-290 version - *Version R-290, consulter



- **Opcional:** interfaz WIFI permite visualizar alarmas, estados de la máquina, historial HACCP y acceder a operaciones de configuración desde PC, smartphone o tableta

- **Optional:** WIFI interface to visualize alarms, machine statuses, HACCP history and let access configuration operations from PC, smartphone, or tablet

- **En option:** l'interface WIFI vous permet de visualiser les alarmes, les états de la machine, l'historique HACCP et d'accéder aux opérations de configuration depuis un PC, un smartphone ou une tablette

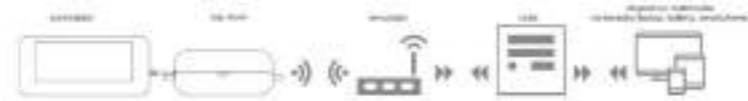

DA10N **7.765€**

Características técnicas y constructivas sujetas a variación sin previo aviso. / We reserve the right to change specifications without prior notice. / Sujet technique et la conception de modifications sans préavis.



DA10N



DA15N



Capacidad interior combinada GN1/1 y 60x40
GN1/1 and 60x40 combined inner capacity
Capacité intérieure combinée GN1 / 1 et 60x40

CARACTERÍSTICAS TÉCNICAS	TECHNICAL DATA	CARACTÉRISTIQUES TECHNIQUES
<ul style="list-style-type: none"> Exterior en acero inox AISI-304, excepto el respaldo Interior en acero inox AISI-304 Puertas con sistema de cierre automático y burlete magnético (permanece abierta al superar los 90° de apertura) Microrruptor apertura de puerta inductivo Encimera de acero inox AISI-304 Capacidad interior combinada GN1/1 y 60x40 (cubetas o bandejas no incluidas) Unidad condensadora ventilada Evaporador sistema tiro forzado, con recubrimiento epoxi anticorrosión Válvula de expansión Aislamiento de poliuretano inyectado, densidad 40 Kg/m³ Panel de control gráfico con pantalla táctil TFT de 5 pulgadas, IP65 Gestión avanzada de las funciones para abatidores de temperatura de última generación. Conectividad RS-485 y USB Sonda de pincho desmontable y calefactada, incluida Gestión de ciclos por tiempo o temperatura Test de correcta inserción de sonda (gestión por temperatura) Grabación de datos HACCP, visualizables en pantalla o descargables por puerto USB en formato CSV Ciclos de abatimiento y congelación "hard/soft" 4 combinaciones de ciclos estándar de abatimiento Programación de ciclo continuo por temperatura o tiempo Múltiples programas personalizables Descarcho por resistencia al inicio de ciclo, optimizado por temperatura Eficiente gestión del consumo de energía 	<ul style="list-style-type: none"> AISI-304 stainless steel exterior, except the rear side Interior in AISI-304 stainless steel Doors with automatic closing system and magnetic gasket (stays open when opening over 90 °) Inductive door opening microswitch AISI-304 stainless steel top GN1/1 and 60x40 combined inner capacity (trays or shelves not included) Ventilated condensing unit Forced air evaporator system with anti-corrosion epoxy coating Expansion valve Injected polyurethane insulation, density 40 Kg/m³ Graphical control panel with 5 inches TFT touch screen, IP65 Advanced management of the functions for the latest generation blast chillers. RS-485 and USB connectivity Included detachable and heated core probe Management of cycles by time or temperature Probe insertion test (temperature management) Recording of HACCP data, viewable on screen or downloadable via USB port in CSV format Chilling and freezing cycles "hard / soft" 4 blast chilling standard cycle combinations Continuous cycle programming by temperature or time Multiple customizable programs Defrost by resistance at the beginning of the cycle, optimized by temperature Efficient management of energy consumption 	<ul style="list-style-type: none"> Extérieur en acier inoxydable AISI-304, sauf le dossier. Intérieur en acier inoxydable AISI-304. Portes avec système de fermeture automatique et coupe-froid magnétique (restent ouvertes lors d'une ouverture à plus de 90°) Micro-interrupteur d'ouverture de porte inductif Dessus en acier inoxydable AISI-304 Capacité intérieure combinée GN1/1 et 60x40 (seaux ou plateaux non inclus) Groupe de condensation ventilé Système à tirage forcé de l'évaporateur, avec revêtement époxy anti-corrosion. Soupape de détente Isolation en polyuréthane injecté, densité 40 Kg/m³ Panneau de contrôle graphique avec écran tactile TFT 5 pouces, IP65 Gestion avancée des fonctions des cellules de refroidissement rapide de dernière génération. Connectivité RS-485 et USB Sonde à pointe amovible et chauffée, incluse Gestion des cycles par temps ou température Test d'insertion de la sonde (gestion de la température) Enregistrement des données HACCP, visualisables à l'écran ou téléchargeables via port USB au format CSV Cycles de refroidissement et de congélation "hard/soft" 4 combinaisons de cycles de refroidissement rapide standard Programmation du cycle continu par température ou temps Plusieurs programmes personnalisables Dégivrage par résistance en début de cycle, optimisé par la température Gestion efficace de la consommation d'énergie

Modelo	Largo	Alto	Fondo	Aislamiento	Capacidad	Capacidad	Ciclo sonda	Ciclo tiempo	Duración	Duración	Voltaje	Refrigerante	Potencia Frig.	Potencia	Producción	Producción	Clase clim.
Model	Length	Height	Depth	Insolment	Capacity	Capacity	Probe Cycle	Time Cycle	Time	Time	Voltage	Refrigerant	Frig. Power	Power	Production	Production	Climatic Class
Modèle	Longueur	Hauteur	Profond.	Isolément	Exposition	Exposition	Cycle sonde	Cycle temps	Duréé	Duréé	Tension	Réfrigérant	Puissance fri.	Puissance	Production	Production	Classe clim.
	mm	mm	mm	mm	GN 1/1-40	60 X 40	L	L	+90/ +3min	+90/ -18min			W	W	+90/ +3 kg.	+90/ -18 kg.	
DA15N	800	1920	800	60	15	15	Si / Yes / Oui	Si / Yes / Oui	120	270	3N 230V 50 Hz	*R-452A	2760	2680	63	37	5 40°C 40%

*Versión R-290, consultar - ask for R-290 version - *Version R-290, consulter



- **Opcional:** interfaz WIFI permite visualizar alarmas, estados de la máquina, historial HACCP y acceder a operaciones de configuración desde PC, smartphone o tableta

- **Optional:** WIFI interface to visualize alarms, machine statuses, HACCP history and let access configuration operations from PC, smartphone, or tablet

- **En option:** l'interface WIFI vous permet de visualiser les alarmes, les états de la machine, l'historique HACCP et d'accéder aux opérations de configuration depuis un PC, un smartphone ou une tablette



Características técnicas y constructivas sujetas a variación sin previo aviso. / We reserve the right to change specifications without prior notice. / Sujet technique et la conception de modifications sans préavis.



DA15N **10.150€**

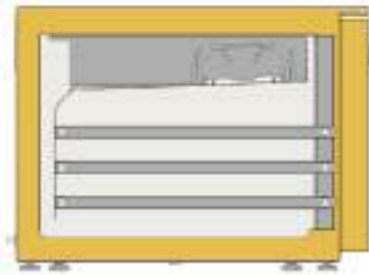

DA3N-S

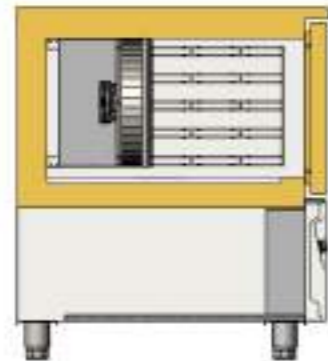

DA5N-S

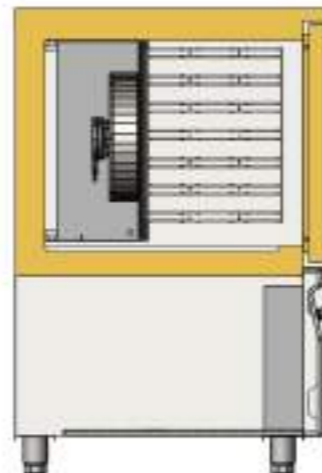

DA7N-S



GN 1/1 - 40

DA7N-S



DA5N-S



DA3N-S

CARACTERÍSTICAS TÉCNICAS

- Exterior en acero inox AISI-304, excepto el respaldo
- Interior en acero inox AISI-304
- Puertas con sistema de cierre automático y burlete magnético (permanece abierta al superar los 90° de apertura)
- Encimera de acero inox AISI-304
- A3N-s capacidad GN 1/1 (cubetas no incluidas)
- A5N-S y A7N-S: Capacidad interior combinada GN1/1 y 60x40 (cubetas o bandejas no incluidas)
- Unidad condensadora ventilada
- Evaporador sistema tiro forzado, con recubrimiento epoxi anticorrosión
- Válvula de expansión
- Aislamiento de poliuretano inyectado, densidad 40 Kg/m³
- Panel de control digital con pantalla táctil, IP65
- Gestión avanzada de las funciones para abatidores de temperatura de última generación.
- Sonda de pincho desmontable, incluida
- Gestión de ciclos por tiempo o temperatura
- Ciclos de abatimiento y congelación "hard/soft"
- 4 combinaciones de ciclos estándar de abatimiento
- Programación de ciclo continuo por temperatura o tiempo
- Descarcho al inicio de ciclo, optimizado por temperatura
- Eficiente gestión del consumo de energía

TECHNICAL DATA

- AISI-304 stainless steel exterior, except the rear side
- Interior in AISI-304 stainless steel
- Doors with automatic closing system and magnetic gasket (stays open when opening over 90°)
- AISI-304 stainless steel top
- A3N-S, GN 1/1 capacity (pans or shelves not included)
- A5N-S and A7N-S: GN1/1 and 60x40 combined inner capacity (pans or shelves not included)
- Ventilated condensing unit
- Forced air evaporator system with anti-corrosion epoxy coating
- Expansion valve
- Injected polyurethane insulation, density 40 Kg/m³
- Digital control panel, IP65
- Advanced management of the functions for the latest generation blast chillers.
- Included detachable core probe
- Management of cycles by time or temperature
- Chilling and freezing cycles "hard / soft"
- 4 blast chilling standard cycle combinations
- Continuous cycle programming by temperature or time
- Defrost at the beginning of the cycle, optimized by temperature
- Efficient management of energy consumption

CARACTÉRISTIQUES TECHNIQUES

- Extérieur en acier inoxydable AISI-304, sauf le dos
- Intérieur en acier inoxydable AISI-304
- Portes avec système de fermeture automatique et coupe-froid magnétique (reste ouvert lors d'une ouverture à plus de 90°)
- Plateau en acier inoxydable AISI-304
- Capacité GN 1/1 A3N-s (godets non inclus)
- A5N-S et A7N-S: capacité intérieure combinée GN1 / 1 et 60x40 (plateaux ou plateaux non inclus)
- Unité de condensation ventilée
- Système de tirage forcé de l'évaporateur, avec revêtement époxy anticorrosion
- Soupape de détente
- Isolation polyuréthane injecté, densité 40 Kg / m³
- Panneau de commande numérique avec écran tactile, IP65
- Gestion avancée des fonctions des cellules de refroidissement rapide de dernière génération.
- Sonde à pointe amovible, incluse
- Gestion des cycles par temps ou température
- Cycles de refroidissement et de congélation "dur / doux"
- 4 combinaisons de cycles de refroidissement rapide standard
- Programmation du cycle continu par température ou temps
- Dégivrage au début du cycle, optimisé par la température
- Gestion efficace de la consommation d'énergie



Modelo	Largo	Alto	Fondo	Aislamiento	Capacidad	Capacidad	Pares guías Sets slides Kit guides	Volumen	Ciclo sonda	Ciclo tiempo	Duración	Duración	Voltaje	Refrigerante	Potencia Fr.	Potencia	Producción	Producción	Clase climática
Model	Length	Height	Depth	Insulation	Capacity	Capacity		Capacity	Probe Cycle	Time Cycle	Time	Time	Voltage	Refrigerant	Fr. Power	Power	Production	Production	Climatic Class
Modèle	Long.	Hauteur	Prof.	Isolément	Exposition	Exposition		Volume	Cycle sonde	Cycle temps	Duréé	Duréé	Tension	Réfrigérant	Puissance fr	Puissance	Production	Production	Classe climatique
	mm	mm	mm	mm	GN 1/1-40	60 X 40		L	L	L	+90/ +3min	+90/ -18min			W	W	+90/ +3 kg.	+90/ -18 kg.	
DA3N-S	715	520	700	45	3	-	3	42	Si / Yes / Oui	Si / Yes / Oui	120	270	1N 230V 50 Hz	R-290 *R-452A	694 690	1100 1140	10 8,8	6,8 5,7	5 40°C 40% 4 30°C 55%
DA5N-S	800	900	800	60	5	4	0	85	Si / Yes / Oui	Si / Yes / Oui	120	270	1N 230V 50 Hz	R-290 *R-452A	907 1042	990 1093	23 19,2	14 11,7	5 40°C 40% 4 30°C 55%
DA7N-S	800	1240	800	60	7	7	0	118	Si / Yes / Oui	Si / Yes / Oui	120	270	1N 230V 50 Hz	R-290 *R-452A	1309 1435	1150 1506	30 26	20 17,2	5 40°C 40% 4 30°C 55%



- **Opcional:** interfaz WIFI permite visualizar alarmas, estados de la máquina, historial HACCP y acceder a operaciones de configuración desde PC, smartphone o tableta

- **Optional:** WIFI interface to visualize alarms, machine statuses, HACCP history and let access configuration operations from PC, smartphone, or tablet

- **En option:** l'interface WIFI vous permet de visualiser les alarmes, les états de la machine, l'historique HACCP et d'accéder aux opérations de configuration depuis un PC, un smartphone ou une tablette

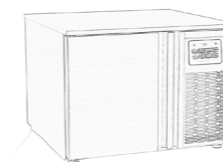
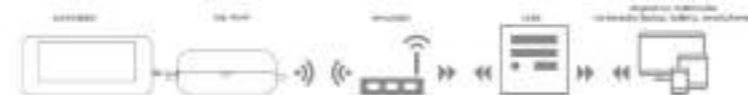

DA3N-S **3.133 €**

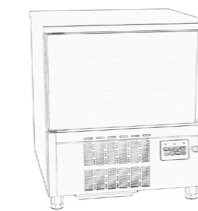

DA5N-S **4.108 €**

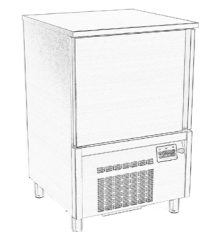

DA7N-S **5.098 €**

9 GAMA AMERICANA US RANGE GAMME AMÉRICAINE



BAJO COCINA Página 375
Mesa fría GN 2/1, refrigeración BAJO COCINA
GN 2/1 counter, chiller UNDER BROILER
Table froide GN 2/1, réfrigération SOUS CUISINE



MESA FRIA Página 377
Mesa fría
Counter chiller
Table froide



MESA FRIA Página 381
Mesa fría preparacion
Cold table preparation
Table froide preparation

MESA FRIA Página 385
Mesa fría cristal elevable
Cold table glass lift
Préparation de la table vitre elevé



ARMARIOS Página 387
Armario GN 2/1, refrigeración y congelados
SNACK cabinet 125
GN 2/1 cabinet, refrigeration and frozen

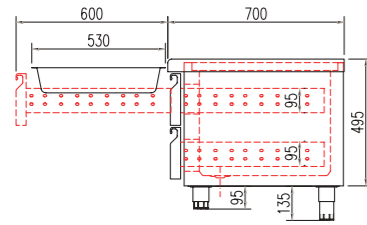

CARACTERÍSTICAS TÉCNICAS	TECHNICAL DATA	CARACTÉRISTIQUES TECHNIQUES
<ul style="list-style-type: none"> - Exterior en acero inox AISI-304, excepto el respaldo - Interior en acero inox AISI-304, con aristas curvas y fondo embutido - Cajoneras refrigeradas inox desmontables sobre guías inox telescópicas, sistema auto-cierre de serie - Encimera de acero inox AISI-304 con frente curvo (opcional con peto sanitario 100 mm) - Posibilidad de fabricar encimera especial a medida - Pies en tubo de acero inox ajustables en altura 95 - 135 mm - Unidad condensadora ventilada y extraíble - Evaporador sistema tiro forzado, con recubrimiento epoxi anticorrosión - Evaporación automática del agua de descarche - Aislamiento de poliuretano inyectado, densidad 40 Kg/m³, cero GWP y cero efecto ODP - Control digital de temperatura, descarches optimizados, alarma por alta temperatura de condensación. Eficiente gestión del consumo de energía - Temperatura de trabajo a 40°C ambiente 	<ul style="list-style-type: none"> - AISI-304 stainless steel exterior, rear side galvanized panel - AISI-304 stainless steel interior, stamped bottom and rounded corners - Stainless steel drawers with telescopic stainless steel slides for complete opening, self-closing system as standard - AISI-304 stainless steel worktop, with rounded front (optional with 100 mm sanitary upstand) - Worktop can be customized on demand - AISI -304 adjustable legs, 95 to 135 mm - Removable and fan assisted condenser unit - Fan assisted evaporator, with epoxi anticorrosion coating. - Automatic evaporation of defrost water - 40 Kg/m³ density polyurethane insulation, zero GWP and zero ODP effect - Digital temperature control, optimized defrost, high-temperature condensation alarm. Efficient management of energy consumption - Operating temperature 40°C ambient 	<ul style="list-style-type: none"> - Extérieur en acier inoxydable AISI-304, à l'exception du dossier - Intérieur en acier inoxydable AISI-304, avec bords incurvés et fond encastré - Tiroirs réfrigérés inox amovibles sur glissières inox télescopiques, système de fermeture automatique en standard - Plan de travail en acier inoxydable AISI-304 avec façade incurvée (en option avec plastron sanitaire de 100 mm) - Possibilité de fabriquer un plan de travail spécial sur mesure - PIEDS en tube inox réglables en hauteur 95 - 135 mm - Groupe de condensation amovible et ventilé - Évaporateur à tirage forcé, avec revêtement époxy anti-corrosion - Évaporation automatique de l'eau de dégivrage - Isolation en polyuréthane injecté, densité 40 Kg/m³, zéro GWP et zéro effet ODP - Contrôle numérique de la température, dégivrages optimisés, alarme de température de condensation élevée. Gestion efficace de la consommation d'énergie - Température de fonctionnement à 40°C ambiant



DKBR-65



DKBR-83

Modelo	Largo	Alto	Fondo	Rango	Estantes	Pares de guías	Capacidad	Voltaje	Refrig.	Potencia Frig.	Consumo Nominal	Rango	clase climate
Model	Length	Height	Depth	Range	Shelves	Sets of slides	Capacity	Voltage	Coolant	Frig Power	Nominal Consumption	Range	2015/1094 EN16825
Modèle	Longueur	Hauteur	Profondeur	Gamme	Étagères	Kit de guides	Exposition	Tension	Frigorigène	Puissance Frig.	Consommation Nominale	Gamme	EN16825
	mm	mm	mm				L			W	W		Rango
DKBR-47	1210 47 ^{2/3}	600 23 ^{5/8}	700 27 ^{1/2}	-2°C +8°C 28°F 46°F	0	0	169	230V-50Hz	R134a*	304	314	D	5 40°C 40%
									R290	502	250	D	5 40°C 40%
DKBR-65	1660 65 ^{1/3}	600 23 ^{5/8}	700 27 ^{1/2}	-2°C +8°C 28°F 46°F	0	0	264	230V-50Hz	R134a*	304	314	E	5 40°C 40%
									R290	502	270	D	5 40°C 40%
DKBR-83	2110 83 ^{1/16}	600 23 ^{5/8}	700 27 ^{1/2}	-2°C +8°C 28°F 46°F	0	0	359	230V-50Hz	R134a*	304	314	E	5 40°C 40%
									R290	502	276	D	5 40°C 40%



OPCIONES · OPTIONS · OPTIONS			
cambio R290 por R134a	change R290 for R134a	changer R290 pour R134a	0 €
cambio R600a por R134a	change R600a for R134a	changer R600a pour R134a	0 €
motor lado izquierdo	left side motor	moteur côté gauche	63 €
encimera con peto	worktop with splash-back	plan de travail avec bavoir	0 €
set 4 ruedas	set 4 wheels	jeu de 4 roues	85 €
set 6 ruedas	set 6 wheels	set 6 roues	127 €
registrar de alarmas HACCP	HACCP alarm recorder	Enregistreur d'alarme HACCP	consultar
respaldo inox	SS rear side	support en acier inoxydable	consultar
230V 60Hz / 115V 60Hz	230V 60Hz / 115V 60Hz	230V 60Hz / 115V 60Hz	consultar

DKBR-47 2.922 €	DKBR-65 4.036 €	DKBR-83 4.906 €

Características técnicas y constructivas sujetas a variación sin previo aviso. / We reserve the right to change specifications without prior notice. / Sujet technique et la conception de modifications sans préavis.



DSD-72
con cajoneras opcionales
with optional drawers sets



Puertas con doble bisagra
Double hinged doors



DSD-27



DSD-60

CARACTERÍSTICAS TÉCNICAS	TECHNICAL DATA	CARACTÉRISTIQUES TECHNIQUES
<ul style="list-style-type: none"> - Exterior e interior en acero, respaldo en chapa galvanizada - Puertas de apertura reversible, con sistema de cierre automático y burlete magnético (permanece abierta al superar los 90° de apertura) - Encimera inox AISI-304 - Estantes interiores de alambre en acero plastificado, regulables en altura - Ruedas de serie (2 con freno + 2 sin freno) - Unidad condensadora ventilada - Evaporador sistema tiro forzado, con recubrimiento epoxi anticorrosión - Evaporación automática del agua de descarche - Aislamiento de poliuretano inyectado, densidad 40 Kg/m³, cero GWP y cero efecto ODP - Control digital de temperatura, descarches optimizados, alarma por alta temperatura de condensación. Eficiente gestión del consumo de energía - Temperatura de trabajo a 38°C ambiente 	<ul style="list-style-type: none"> - Exterior and interior in steel, backrest in galvanized sheet - Reversible opening doors, with automatic closing system and magnetic weatherstripping (remains open when opening over 90 °) - AISI-304 stainless steel countertop - Interior shelves made of plasticized steel wire, adjustable in height - Standard wheels (2 with brake + 2 without brake) - Ventilated condensing unit - Forced draft system evaporator, with anti-corrosion epoxy coating - Automatic evaporation of defrost water - Injected polyurethane insulation, density 40 Kg / m³, zero GWP and zero ODP effect - Digital temperature control, optimized defrosts, high condensation temperature alarm. Efficient management of energy consumption - Working temperature at 38 ° C ambient 	<ul style="list-style-type: none"> - Extérieur et intérieur en acier, dossier en tôle galvanisée - Portes à ouverture réversible, avec système de fermeture automatique et coupe-froid magnétique (reste ouverte lors d'une ouverture à plus de 90°) - Comptoir en acier inoxydable AISI-304 - Étagères intérieures en fil d'acier plastifié, réglables en hauteur - Roues standard (2 avec frein + 2 sans frein) - Groupe de condensation ventilé - Évaporateur à tirage forcé, avec revêtement époxy anti-corrosion - Évaporation automatique de l'eau de dégivrage - Isolation en polyuréthane injecté, densité 40 Kg/m³, zéro GWP et zéro effet ODP - Contrôle numérique de la température, dégivrages optimisés, alarme de température de condensation élevée. Gestion efficace de la consommation d'énergie - Température de fonctionnement à 38°C ambiant

Modelo Modèle	Largo Length Longueur mm	Alto Height Hauteur mm	Fondo Depth Profondeur mm	Rango Range Gamme	Estantes Shelves Étagères	Capacidad Capacity Exposition L	Voltaje Voltage Tension	Refrig. Coolant Frigorigène	Potencia Frig. Frig Power Puissance Frig. W	Consumo Nominal Nominal Consumption Consommation Nominale W	Rango Range Gamme	clase climate 2015/1094 EN16825
DSD-27	701 27 ³ / ₅	915 36 ¹ / ₃₂	805 32 ¹ / ₉	-2°C +8°C 28°F 46°F	2	204	230V-50Hz	R134a* R290	304 502	343 264	- C	5 40°C 40%
DSD-48	1228 48 ¹ / ₃	915 36 ¹ / ₃₂	805 32 ¹ / ₉	-2°C +8°C 28°F 46°F	4	394	230V-50Hz	R134a* R290	336 502	286 725	- C	5 40°C 40%
DSD-60	1532 60 ⁵ / ₁₆	915 36 ¹ / ₃₂	805 32 ¹ / ₉	-2°C +8°C 28°F 46°F	4	500	230V-50Hz	R134a* R290	485 845	455 929	- D	5 40°C 40%
DSD-72	1837 72 ¹ / ₃	915 36 ¹ / ₃₂	805 32 ¹ / ₉	-2°C +8°C 28°F 46°F	6	606	230V-50Hz	R134a* R290	540 845	470 935	- D	5 40°C 40%
DSDN-27	701 27 ³ / ₅	915 36 ¹ / ₃₂	805 32 ¹ / ₉	-20°C -15°C -4°F +5°F	2	204	230V-50Hz	R449A*	361	300	-	4 30°C 55%
DSDN-48	1228 48 ¹ / ₃	915 36 ¹ / ₃₂	805 32 ¹ / ₉	-20°C -15°C -4°F +5°F	4	394	230V-50Hz	R449A*	730	695	-	4 30°C 55%
DSDN-60	1532 60 ⁵ / ₁₆	915 36 ¹ / ₃₂	805 32 ¹ / ₉	-20°C -15°C -4°F +5°F	4	500	230V-50Hz	R449A*	907	784	-	4 30°C 55%

OPCIONES · OPTIONS · OPTIONS			
encimera con peto	worktop with splash-back	plan de travail avec bavoire	consultar
set 4 patas	set 4 legs	ensemble 4 pattes	0 €
set 6 patas	set 6 legs	set 6 pattes	0 €
respaldo inox	SS rear side	support en acier inoxydable	consultar
tropicalizado 43°C	tropicalized 43 ° C	tropicalisé 43°C	consultar
230V 60Hz / 115V 60Hz	230V 60Hz / 115V 60Hz	230V 60Hz / 115V 60Hz	consultar
cambio R290 por R134a	change R290 for R134a	changer R290 pour R134a	0 €
cambio R290 por R449A	change R290 for R449A	changer R290 pour R449A	0 €
cajonera doble inox, auto-cierre	double SS drawer, self-closing	tiroir double en acier inoxydable, à fermeture automatique	508 €

Características técnicas y constructivas sujetas a variación sin previo aviso. / We reserve the right to change specifications without prior notice. / Sujet technique et la conception de modifications sans préavis.

DSD-27 1.643 €	DSD-48 2.186 €	DSD-60 2.381 €	DSD-72 2.708 €
DSDN-27 2.521 €	DSDN-48 3.078 €	DSDN-60 3.425 €	

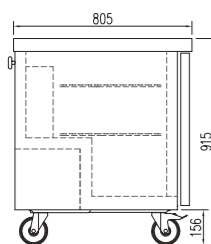

DSDV-72



Puertas con doble bisagra
Double hinged doors



DSDV-27



DSDV-48

CARACTERÍSTICAS TÉCNICAS	TECHNICAL DATA	CARACTÉRISTIQUES TECHNIQUES
<ul style="list-style-type: none"> - Exterior e interior en acero, respaldo en chapa galvanizada - Puertas de doble cristal, sobre marco de aluminio - Puertas de apertura reversible, con sistema de cierre automático y burlete magnético (permanece abierta al superar los 90° de apertura) - Encimera inox AISI-304 - Estantes interiores de alambre en acero plastificado, regulables en altura - Ruedas de serie (2 con freno + 2 sin freno) - Unidad condensadora ventilada - Evaporador sistema tiro forzado, con recubrimiento epoxi anticorrosión - Evaporación automática del agua de descarche - Aislamiento de poliuretano inyectado, densidad 40 Kg/m³, cero GWP y cero efecto ODP - Control digital de temperatura, descarches optimizados, alarma por alta temperatura de condensación. Eficiente gestión del consumo de energía - Temperatura de trabajo a 32°C ambiente 	<ul style="list-style-type: none"> - Exterior and interior in steel, backrest in galvanized sheet - Double glass doors, on aluminum frame - Reversible opening doors, with automatic closing system and magnetic weatherstripping (remains open when opening over 90 °) - AISI-304 stainless steel countertop - Interior shelves made of plasticized steel wire, adjustable in height - Standard wheels (2 with brake + 2 without brake) - Ventilated condensing unit - Forced draft system evaporator, with anti-corrosion epoxy coating - Automatic evaporation of defrost water - Injected polyurethane insulation, density 40 Kg / m³, zero GWP and zero ODP effect - Digital temperature control, optimized defrosts, high condensation temperature alarm. Efficient management of energy consumption - Working temperature at 32 °C ambient 	<ul style="list-style-type: none"> - Extérieur et intérieur en acier, dossier en tôle galvanisée - Portes double vitrage, sur châssis aluminium - Portes à ouverture réversible, avec système de fermeture automatique et coupe-froid magnétique (reste ouverte lors d'une ouverture à plus de 90°) - Comptoir en acier inoxydable AISI-304 - Étagères intérieures en fil d'acier plastifié, réglables en hauteur - Roues standard (2 avec frein + 2 sans frein) - Groupe de condensation ventilé - Évaporateur à tirage forcé, avec revêtement époxy anti-corrosion - Évaporation automatique de l'eau de dégivrage - Isolation en polyuréthane injecté, densité 40 Kg/m³, zéro GWP et zéro effet ODP - Contrôle numérique de la température, dégivrages optimisés, alarme de température de condensation élevée. Gestion efficace de la consommation d'énergie - Température de fonctionnement à 32°C ambiant

Modelo Modèle	Largo Length Longueur mm	Alto Height Hauteur mm	Fondo Depth Profondeur mm	Rango Range Gamme	Estantes Shelves Étagères	Capacidad Capacity Exposition L	Voltaje Voltage Tension	Refrig. Coolant Frigorigène	Potencia Frig. Frig Power Puissance Frig. W	Consumo Nominal Nominal Consumption Consommation Nominale W	Rango Range Gamme	clase climate 2015/1094 EN16825	
DSDV-27	-2°C +8°C	28°F 46°F	701 273/5	915 361/32	805 321/9	2	204	230V-50Hz	R134a*	304	349	-	5 40°C 40%
									R290	502	271	C	5 40°C 40%
DSDV-48	-2°C +8°C	28°F 46°F	1228 481/3	915 361/32	805 321/9	4	394	230V-50Hz	R134a*	336	298	-	5 40°C 40%
									R290	502	737	C	5 40°C 40%
DSDV-60	-2°C +8°C	28°F 46°F	1532 605/16	915 361/32	805 321/9	4	500	230V-50Hz	R134a*	485	466	-	5 40°C 40%
									R290	845	941	D	5 40°C 40%
DSDV-72	-2°C +8°C	28°F 46°F	1837 721/3	915 361/32	805 321/9	6	606	230V-50Hz	R134a*	540	487	-	5 40°C 40%
									R290	845	952	D	5 40°C 40%

OPCIONES · OPTIONS · OPTIONS			
encimera con peto	worktop with splash-back	plan de travail avec bavoir	consultar
set 4 patas	set 4 legs	ensemble 4 pattes	0 €
set 6 patas	set 6 legs	set 6 pattes	0 €
registrador de alarmas HACCP	HACCP alarm recorder	Enregistreur d'alarme HACCP	consultar
respaldo inox	SS rear side	support en acier inoxydable	consultar
tropicalizado 43°C	tropicalized 43 °C	tropicalisé 43°C	consultar
230V 60Hz / 115V 60Hz	230V 60Hz / 115V 60Hz	230V 60Hz / 115V 60Hz	consultar
cambio R290 por R134a	change R290 for R134a	changer R290 pour R134a	0 €
cajonera doble inox, auto-cierre	double SS drawer, self-closing	tiroir double en acier inoxydable, à fermeture automatique	508 €

Características técnicas y constructivas sujetas a variación sin previo aviso. / We reserve the right to change specifications without prior notice. / Sujet technique et la conception de modifications sans préavis.

DSDV-27 1.910 €	DSDV-48 2.628 €	DSDV-60 2.902 €	DSDV-72 3.404 €

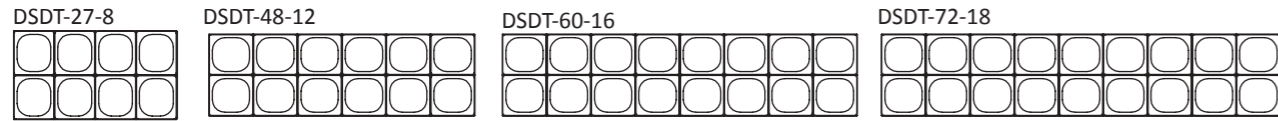

Cubetas GN NO incluidas en el precio / GN containers NOT included in price / Seaux GN NON inclus dans le prix

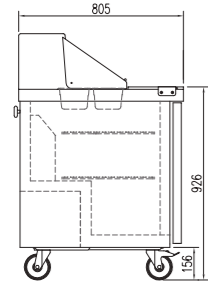

DSDT-72-18
con cajonera opcional
with optional drawer set

Puertas con doble bisagra y burlete desmontable
Double hinged doors and detachable gasket



DSDT-27-8



DSDT-60-16

CARACTERÍSTICAS TÉCNICAS	TECHNICAL DATA	CARACTÉRISTIQUES TECHNIQUES
<ul style="list-style-type: none"> - Exterior e interior en acero, respaldo en chapa galvanizada - Puertas de apertura reversible, con sistema de cierre automático y burlete magnético (permanece abierta al superar los 90° de apertura) - Encimera inox AISI 304 con tabla de polietileno desmontable, color blanco - Estantes interiores de alambre en acero plastificado, regulables en altura - Capacidad cubetas GN en la encimera - Cubierta inox AISI-304, aislada, abatible sobre alojamiento cubetas - Estantes interiores de alambre en acero plastificado, regulables en altura - Ruedas de serie (2 con freno + 2 sin freno) - Unidad condensadora ventilada - Evaporador sistema tiro forzado, con recubrimiento epoxi anticorrosión - Evaporación automática del agua de descarche - Aislamiento de poliuretano inyectado, densidad 40 Kg/m³, cero GWP y cero efecto ODP - Control digital de temperatura, descarches optimizados, alarma por alta temperatura de condensación. Eficiente gestión del consumo de energía - Temperatura de trabajo 0°C +8°C a 38°C ambiente 	<ul style="list-style-type: none"> - Exterior and interior in steel, backrest in galvanized sheet - Reversible opening doors, with automatic closing system and magnetic weatherstripping (remains open when opening over 90 °) - AISI 304 stainless steel top with removable polyethylene table, white color - Interior shelves made of plasticized steel wire, adjustable in height - Capacity GN buckets on the worktop - AISI-304 stainless steel cover, insulated, folding over the tray housing - Interior shelves made of plasticized steel wire, adjustable in height - Standard wheels (2 with brake + 2 without brake) - Ventilated condensing unit - Forced draft system evaporator, with anti-corrosion epoxy coating - Automatic evaporation of defrost water - Injected polyurethane insulation, density 40 Kg / m³, zero GWP and zero ODP effect - Digital temperature control, optimized defrosts, high condensation temperature alarm. Efficient management of energy consumption - Working temperature 0 ° C + 8 ° C to 38 ° C ambient 	<ul style="list-style-type: none"> - Extérieur et intérieur en acier, dossier en tôle galvanisée - Portes à ouverture réversible, avec système de fermeture automatique et coupe-froid magnétique (reste ouverte lors d'une ouverture à plus de 90°) - Plateau en acier inoxydable AISI 304 avec table amovible en polyéthylène, couleur blanche - Étagères intérieures en fil d'acier plastifié, réglables en hauteur - Capacité seaux GN sur le plan de travail - Couvercle en acier inoxydable AISI-304, isolé, rabattable sur le boîtier du plateau - Étagères intérieures en fil d'acier plastifié, réglables en hauteur - Roues standard (2 avec frein + 2 sans frein) - Groupe de condensation ventilé - Évaporateur à tirage forcé, avec revêtement époxy anti-corrosion - Évaporation automatique de l'eau de dégivrage - Isolation en polyuréthane injecté, densité 40 Kg/m³, zéro GWP et zéro effet ODP - Contrôle numérique de la température, dégivrages optimisés, alarme de température de condensation élevée. Gestion efficace de la consommation d'énergie - Température de fonctionnement 0°C + 8°C à 38°C ambiant

Modelo Model Modèle	Largo Length Longueur mm	Fondo Depth Profondeur mm	Perfiles GN GN Supports Profils GN mm	Rango Range Gamme	Estantes Shelves Étagères	Capacidad Capacity Exposition L	Encimera Worktop GN1/6-100	Voltaje Voltage Tension	Refrig. Coolant Frigorigène	Potencia Frig. Frig Power Puissance Frig. W	Consumo Nominal Nominal Consumption Consommation Nominale W
DSDT-27-8	701 273/5	805 321/9	1	0°C +8°C / 32°F 46°F	2	204	8	230V-50Hz	R134a* R290	304 502	349 271
DSDT-48-12	1228 481/3	805 321/9	1	0°C +8°C / 32°F 46°F	4	394	12	230V-50Hz	R134a* R290	336 502	298 737
DSDT-60-16	1532 605/16	805 321/9	1	0°C +8°C / 32°F 46°F	4	500	16	230V-50Hz	R134a* R290	485 845	466 941
DSDT-72-18	1837 721/3	805 321/9	1	0°C +8°C / 32°F 46°F	6	606	18	230V-50Hz	R134a* R290	540 845	487 952

OPCIONES · OPTIONS · OPTIONS			
encimera con peto	worktop with splash-back	plan de travail avec bavoire	consultar
set 4 patas	set 4 legs	ensemble 4 pattes	0 €
set 6 patas	set 6 legs	set 6 pattes	0 €
registrador de alarmas HACCP	HACCP alarm recorder	Enregistreur d'alarme HACCP	consultar
respaldo inox	SS rear side	support en acier inoxydable	consultar
tropicalizado 43°C	tropicalized 43 ° C	tropicalisé 43°C	consultar
230V 60Hz / 115V 60Hz	230V 60Hz / 115V 60Hz	230V 60Hz / 115V 60Hz	consultar
cambio R290 por R134a	change R290 for R134a	changer R290 pour R134a	0 €
cajonera doble inox, auto-cierre	double SS drawer, self-closing	tiroir double en acier inoxydable, à fermeture automatique	508 €

DSDT-27-8 1.883 €	DSDT-48-12 2.574 €	DSDT-60-16 2.869 €	DSDT-72-18 3.272 €

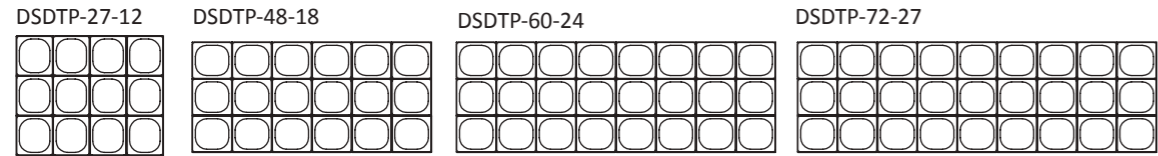

Cubetas GN NO incluidas en el precio / GN containers NOT included in price / Seaux GN NON inclus dans le prix

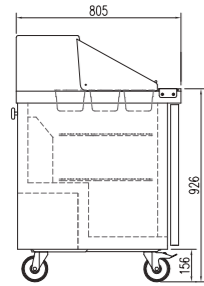

DSDTP-72-27
con cajonera opcional
with optional drawer set



Puertas con doble bisagra
Double hinged doors



DSDTP-27-12



DSDTP-60-24

CARACTERÍSTICAS TÉCNICAS

- Exterior e interior en acero, respaldo en chapa galvanizada
- Puertas de apertura reversible, con sistema de cierre automático y burlete magnético (permanece abierta al superar los 90° de apertura)
- Encimera inox AISI 304 con tabla de polietileno desmontable, color blanco
- Estantes interiores de alambre en acero plastificado, regulables en altura
- Capacidad cubetas GN en la encimera
- Cubierta inox AISI-304, aislada, abatible sobre alojamiento cubetas
- Estantes interiores de alambre en acero plastificado, regulables en altura
- Ruedas de serie (2 con freno + 2 sin freno)
- Unidad condensadora ventilada
- Evaporador sistema tiro forzado, con recubrimiento epoxi anticorrosión
- Evaporación automática del agua de descarche
- Aislamiento de poliuretano inyectado, densidad 40 Kg/m³, cero GWP y cero efecto ODP
- Control digital de temperatura, descarches optimizados, alarma por alta temperatura de condensación. Eficiente gestión del consumo de energía
- Temperatura de trabajo 0°C +8°C a 38°C ambiente

TECHNICAL DATA

- Exterior and interior in steel, backrest in galvanized sheet
- Reversible opening doors, with automatic closing system and magnetic weatherstripping (remains open when opening over 90 °)
- AISI 304 stainless steel top with removable polyethylene table, white color
- Interior shelves made of plasticized steel wire, adjustable in height
- Capacity GN buckets on the worktop
- AISI-304 stainless steel cover, insulated, folding over the tray housing
- Interior shelves made of plasticized steel wire, adjustable in height
- Standard wheels (2 with brake + 2 without brake)
- Ventilated condensing unit
- Forced draft system evaporator, with anti-corrosion epoxy coating
- Automatic evaporation of defrost water
- Injected polyurethane insulation, density 40 Kg / m³, zero GWP and zero ODP effect
- Digital temperature control, optimized defrosts, high condensation temperature alarm. Efficient management of energy consumption
- Working temperature 0 ° C + 8 ° C to 38 ° C ambient

CARACTÉRISTIQUES TECHNIQUES

- Extérieur et intérieur en acier, dossier en tôle galvanisée
- Portes à ouverture réversible, avec système de fermeture automatique et coupe-froid magnétique (reste ouverte lors d'une ouverture à plus de 90°)
- Plateau en acier inoxydable AISI 304 avec table amovible en polyéthylène, couleur blanche
- Étagères intérieures en fil d'acier plastifié, réglables en hauteur
- Capacité seaux GN sur le plan de travail
- Couvercle en acier inoxydable AISI-304, isolé, rabattable sur le boîtier du plateau
- Étagères intérieures en fil d'acier plastifié, réglables en hauteur
- Roues standard (2 avec frein + 2 sans frein)
- Groupe de condensation ventilé
- Évaporateur à tirage forcé, avec revêtement époxy anti-corrosion
- Évaporation automatique de l'eau de dégivrage
- Isolation en polyuréthane injecté, densité 40 Kg/m³, zéro GWP et zéro effet ODP
- Contrôle numérique de la température, dégivrages optimisés, alarme de température de condensation élevée. Gestion efficace de la consommation d'énergie
- Température de fonctionnement 0°C + 8°C à 38°C ambient



Modelo Model Modèle	Largo Length Longueur mm	Fondo Depth Profondeur mm	Perfiles GN GN Supports Profils GN mm	Rango Range Gamme	Estantes Shelves Étagères	Capacidad Capacity Exposition L	Encimera Worktop GN1/6-100	Voltaje Voltage Tension	Refrig. Coolant Frigorigène	Potencia Frig. Frig Power Puissance Frig. W	Consumo Nominal Nominal Consumption Consommation Nominale W	
DSDT-27-8	701 27 3/5	805 32 1/9	2	0°C +8°C	32°F 46°F	2	204	12	230V-50Hz	R134a*	304	349
										R290	502	271
DSDT-48-12	1228 48 1/3	805 32 1/9	2	0°C +8°C	32°F 46°F	4	394	18	230V-50Hz	R134a*	336	298
										R290	502	737
DSDT-60-16	1532 60 5/16	805 32 1/9	2	0°C +8°C	32°F 46°F	4	500	24	230V-50Hz	R134a*	485	466
										R290	845	941
DSDT-72-18	1837 72 1/3	805 32 1/9	2	0°C +8°C	32°F 46°F	6	606	27	230V-50Hz	R134a*	540	487
										R290	845	952

OPCIONES - OPTIONS - OPTIONS

encimera con peto	worktop with splash-back	plan de travail avec bavoir	consultar
set 4 patas	set 4 legs	ensemble 4 pattes	0 €
set 6 patas	set 6 legs	set 6 pattes	0 €
registrador de alarmas HACCP	HACCP alarm recorder	Enregistreur d'alarme HACCP	consultar
respaldo inox	SS rear side	support en acier inoxydable	consultar
tropicalizado 43°C	tropicalized 43 ° C	tropicalisé 43°C	consultar
230V 60Hz / 115V 60Hz	230V 60Hz / 115V 60Hz	230V 60Hz / 115V 60Hz	consultar
cambio R290 por R134a	change R290 for R134a	changer R290 pour R134a	0 €
cajonera doble inox, auto-cierre	double SS drawer, self-closing	tiroir double en acier inoxydable, à fermeture automatique	508 €



DSDTP-27-12 **2.057 €**



DSDTP-48-18 **2.689 €**



DSDTP-60-24 **2.963 €**



DSDTP-72-27 **3.390 €**

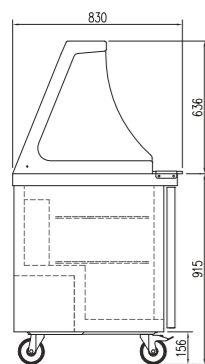

Puertas con doble bisagra y burlete desmontable
Double hinged doors and detachable gasket



DSDTP-48-18-LGL
con cajonera opcional
with optional drawer set

Cubetas GN NO incluidas en el precio / GN containers NOT included in price / Seaux GN NON inclus dans le prix

CARACTERÍSTICAS TÉCNICAS

- Exterior en acero, incluido el respaldo
- Interior en acero, con aristas curvas y fondo embutido
- Puertas de apertura reversible, con sistema de cierre automático y burlete magnético (permanece abierta al superar los 90° de apertura)
- Encimera inox con capacidad cubetas GN (ver detalle)
- Tabla de corte en polietileno
- Perfiles divisorios fijos (desmontable para limpieza) para apoyo de las cubetas
- Robusta estructura elevable, con doble cristal para mantener la temperatura del área de cubetas
- Máxima visibilidad del producto, LED 6500 K
- Opción LED 3000 K (luz cálida) o Rosa al mismo precio
- Sellado del perímetro de la cubierta por burletes
- Sistema de pistones y amortiguadores para compensar el peso
- Estantes interiores de alambre en acero plastificado, regulables en altura
- Ruedas de serie (2 con freno + 2 sin freno)
- Unidad condensadora ventilada
- Evaporador sistema tiro forzado, con recubrimiento epoxi anticorrosión
- Evaporación automática del agua de descarche
- Aislamiento de poliuretano inyectado, densidad 40 Kg/m³, cero efectos ODP y GWP
- Control digital de temperatura, descargas optimizadas, alarma por alta temperatura de condensación. Eficiente gestión del consumo de energía
- Temperatura de trabajo a 32°C ambiente

TECHNICAL DATA

- Exterior in steel, including the backrest
- Steel interior, with curved edges and inlaid bottom
- Reversible opening doors, with automatic closing system and magnetic weatherstripping (remains open when opening over 90 °)
- Stainless steel worktop with capacity for GN trays (see detail)
- Polyethylene cutting board
- Fixed dividing profiles (removable for cleaning) to support the trays
- Robust lifting structure, with double glass to maintain the temperature of the cuvette area
- Maximum product visibility, 6500 K LED
- Option LED 3000 K (warm light) or Pink at the same price
- Sealing of the perimeter of the roof by weatherstripping
- System of pistons and shock absorbers to compensate the weight
- Interior shelves made of plasticized steel wire, adjustable in height
- Standard wheels (2 with brake + 2 without brake)
- Ventilated condensing unit
- Forced draft system evaporator, with anti-corrosion epoxy coating
- Automatic evaporation of defrost water
- Injected polyurethane insulation, density 40 Kg / m³, zero ODP and GWP effects
- Digital temperature control, optimized defrosts, high condensation temperature alarm. Efficient management of energy consumption
- Working temperature at 32 ° C ambient

CARACTÉRISTIQUES TECHNIQUES

- Extérieur en acier, y compris le dossier
- Intérieur en acier, avec bords incurvés et fond incrusté
- Portes à ouverture réversible, avec système de fermeture automatique et coupe-froid magnétique (reste ouverte lors d'une ouverture à plus de 90°)
- Plan de travail en inox avec capacité pour bacs GN (voir détail)
- Planche à découper en polyéthylène
- Profils de séparation fixes (amovibles pour le nettoyage) pour soutenir les plateaux
- Structure de levage robuste, avec double verre pour maintenir la température de la zone de la cuvette
- Visibilité maximale du produit, LED 6500 K
- Option LED 3000 K (lumière chaude) ou Rose au même prix
- Scellement du périmètre de la toiture par coupe-froid
- Système de pistons et amortisseurs pour compenser le poids
- Étagères intérieures en fil d'acier plastifié, réglables en hauteur
- Roues standard (2 avec frein + 2 sans frein)
- Groupe de condensation ventilé
- Évaporateur à tirage forcé, avec revêtement époxy anti-corrosion
- Évaporation automatique de l'eau de dégivrage
- Isolation en polyuréthane injecté, densité 40 Kg/m³, zéro effets ODP et GWP
- Contrôle numérique de la température, dégivrages optimisés, alarme de température de condensation élevée. Gestion efficace de la consommation d'énergie
- Température de fonctionnement à 32°C ambiant

MESA FRIA PREPARACION CON TAPA DE CRISTAL ELEVABLE

COLD PREPARATION TABLE WITH ELEVABLE GLASS LID · TABLE DE PRÉPARATION À FROID AVEC COUVERCLE VERRE ÉLÉVABLE



DSDTP-48-18-LGL



DSDTP-48-18-LGL

9 US RANGE

Modelo Modèle	Largo Length Longueur mm	Fondo Depth Profondeur mm	Perfiles GN GN Supports Profils GN mm	Rango Range Gamme	Estantes Shelves Étagères	Capacidad Capacity Exposition L	Encimera Worktop GN1/6-100	Voltaje Voltage Tension	Refrig. Coolant Frigorigène	Potencia Frig. Frig Power Puissance Frig. W	Consumo Nominal Nominal Consumption Consommation Nominale W
DSDTP-27-9-LGL	701 27 ³ / ₅	830 32 ² / ₃	2	0°C +8°C 32°F 46°F	2	204	9	230V-50Hz	R134a* R290	304 502	296 275
DSDTP-48-18-LGL	1228 48 ¹ / ₃	830 32 ² / ₃	2	0°C +8°C 32°F 46°F	4	394	18	230V-50Hz	R134a* R290	336 502	353 375

OPCIONES · OPTIONS · OPTIONS

set 4 ruedas	set 4 wheels	jeu de 4 roues	85 €
230V 60Hz / 115V 60Hz	230V 60Hz / 115V 60Hz	230V 60Hz / 115V 60Hz	consultar
cambio R290 por R134a	change R290 for R134a	changer R290 pour R134a	0 €
cajonera doble inox, auto-cierre	double SS drawer, self-closing	tiroir double en acier inoxydable, à fermeture automatique	508 €



DSDTP-27-9-LGL 3.077 €



DSDTP-48-18-LGL 3.771 €

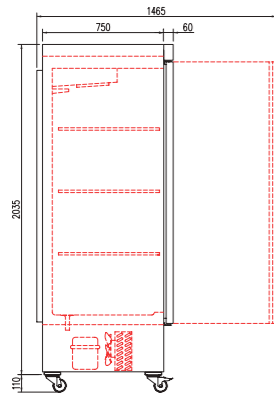

DUPR-55



DUPR-27



DUPR-55

CARACTERÍSTICAS TÉCNICAS	TECHNICAL DATA	CARACTÉRISTIQUES TECHNIQUES
- Exterior en acero excepto el respaldo	- Exterior in steel except the backrest	- Extérieur en acier sauf le dossier
- Interior en acero, con aristas curvas y fondo embutido	- Steel interior, with curved edges and inlaid bottom	- Intérieur en acier, avec bords incurvés et fond incrusté
- Puertas de apertura reversible, con sistema de cierre automático y burlete magnético (permanece abierta al superar los 90° de apertura)	- Reversible opening doors, with automatic closing system and magnetic weatherstripping (remains open when opening over 90 °)	- Portes à ouverture réversible, avec système de fermeture automatique et coupe-froid magnétique (reste ouverte lors d'une ouverture à plus de 90°)
- Contrapuerta inox embutida	- Embedded stainless steel door	- Porte encastrée en acier inoxydable
- Luz interior LED	- LED interior light	- Eclairage intérieur LED
- Estantes interiores de alambre en acero plastificado, regulables en altura	- Interior shelves made of plasticized steel wire, adjustable in height	- Étagères intérieures en fil d'acier plastifié, réglables en hauteur
- Ruedas de serie (2 con freno + 2 sin freno)	- Standard wheels (2 with brake + 2 without brake)	- Roues standard (2 avec frein + 2 sans frein)
- Cuadro de mandos y rejilla ventilación motor, desmontables	- Removable control panel and motor ventilation grille	- Panneau de commande amovible et grille de ventilation du moteur
- Unidad condensadora ventilada	- Ventilated condensing unit	- Groupe de condensation ventilé
- Evaporador sistema tiro forzado, con recubrimiento epoxi anticorrosión	- Forced draft system evaporator, with anti-corrosion epoxy coating	- Évaporateur à tirage forcé, avec revêtement époxy anti-corrosion
- Paro ventiladores tiro forzado al abrir la puerta	- Forced draft fans stop when the door is opened	- Les ventilateurs à tirage forcé s'arrêtent lorsque la porte est ouverte
- Evaporación automática del agua de descarche	- Automatic evaporation of defrost water	- Évaporation automatique de l'eau de dégivrage
- Aislamiento de poliuretano inyectado, densidad 40 Kg/m³, cero efectos ODP y GWP	- Injected polyurethane insulation, density 40 Kg / m³, zero ODP and GWP effects	- Isolation en polyuréthane injecté, densité 40 Kg/m³, zéro effets ODP et GWP
- Control digital de temperatura, descarches optimizados, alarma por alta temperatura de condensación. Eficiente gestión del consumo de energía	- Digital temperature control, optimized defrosts, high condensation temperature alarm. Efficient management of energy consumption	- Contrôle numérique de la température, dégivrages optimisés, alarme de température de condensation élevée. Gestion efficace de la consommation d'énergie
- Temperatura de trabajo : 38°C	- Working temperature: 38 ° C	- Température de fonctionnement : 38°C

Modelo Model Modèle	Largo Length Longueur mm	Alto Height Hauteur mm	Fondo Depth Profondeur mm	Rango Range Gamme	Estantes Shelves Étagères	Capacidad Capacity Exposition L	Voltaje Voltage Tension	Refrig. Coolant Frigorigène	Potencia Frig. Frig Power Puissance Frig. W	Consumo Nominal Nominal Consumption Consommation Nominale W	CCE EEC 2015/ 1094 EN16825	clase climate 2015/1094 EN16825
DUPR-27	660 26	2145 847/16	845 331/4	-2°C +8°C 28°F 46°F	3	645	230V-50Hz	R134a* R290	245 502	253 243	- C	5 5 40°C 40%
DUPR-55	1350 561/16	2145 847/16	845 331/4	-2°C +8°C 28°F 46°F	6+3	1404	230V-50Hz	R134a* R290	485 845	442 373	- D	5 5 40°C 40%
DUPR-82	2035 801/8	2145 847/16	845 331/4	-2°C +8°C 28°F 46°F	9+6	2197	230V-50Hz	R290 R449A*	1702 1215	897 894	- -	5 5 40°C 40%
DUPL-27	660 26	2145 847/16	845 331/4	-20°C -15°C -4°F +5°F	3	645	230V-50Hz	R290 R449A*	606 452	553 620	E -	5 4 30°C 40%
DUPL-55	1350 561/16	2145 847/16	845 331/4	-20°C -15°C -4°F +5°F	6+3	1404	230V-50Hz	R290 R449A*	907 1042	952 990	E -	4 4 30°C 55%
DUPL-82	2035 801/8	2145 847/16	845 331/4	-20°C -15°C -4°F +5°F	9+6	2197	230V-50Hz	R290 R449A*	1814 1630	1680 194	E -	4 4 30°C 55%

OPCIONES · OPTIONS · OPTIONS			
encimera con peto	worktop with splash-back	plan de travail avec bavoir	consultar
set 4 patas	set 4 legs	ensemble 4 pattes	0 €
set 6 patas	set 6 legs	set 6 pattes	0 €
respaldo inox	SS rear side	support en acier inoxydable	consultar
tropicalizado 43°C	tropicalized 43 ° C	tropicalisé 43°C	consultar
230V 60Hz / 115V 60Hz	230V 60Hz / 115V 60Hz	230V 60Hz / 115V 60Hz	consultar
cambio R290 por R134a	change R290 for R134a	changer R290 pour R134a	0 €
cambio R290 por R449A	change R290 for R449A	changer R290 pour R449A	0 €
cajonera doble inox, auto-cierre	double SS drawer, self-closing	tiroir double en acier inoxydable, à fermeture automatique	508 €

DUPR-27 2.492 €	DUPR-27-2 2.673 €	DUPR-55 3.331 €	DUPR-55-4 3.749 €	DUPR-82 4.356 €
DUPL-27 2.978 €	DUPL-27-2 3.197 €	DUPL-55 3.921 €	DUPL-55-4 4.640 €	DUPL-82 5.200 €

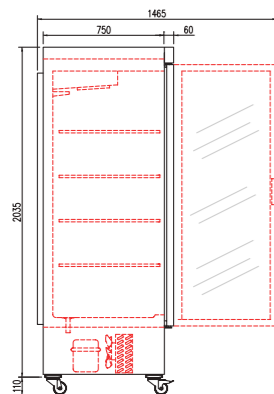

CARACTERÍSTICAS TÉCNICAS

- Exterior en acero excepto el respaldo
- Interior en acero, con aristas curvas y fondo embutido
- Puertas de apertura reversible, con sistema de cierre automático y burlete magnético (permanece abierta al superar los 90° de apertura)
- Doble cristal
- Luz interior LED
- Estantes interiores de alambre en acero plastificado, regulables en altura
- Ruedas de serie (2 con freno + 2 sin freno)
- Cuadro de mandos y rejilla ventilación motor, desmontables
- Unidad condensadora ventilada
- Evaporador sistema tiro forzado, con recubrimiento epoxi anticorrosión
- Paro ventiladores tiro forzado al abrir la puerta
- Evaporación automática del agua de descarche
- Aislamiento de poliuretano inyectado, densidad 40 Kg/m³, cero efectos ODP y GWP
- Control digital de temperatura, descarches optimizados, alarma por alta temperatura de condensación. Eficiente gestión del consumo de energía
- Temperatura de trabajo : 32°C

TECHNICAL DATA

- Exterior in steel except the backrest
- Steel interior, with curved edges and inlaid bottom
- Reversible opening doors, with automatic closing system and magnetic weatherstripping (remains open when opening over 90 °)
- Double glass
- LED interior light
- Interior shelves made of plasticized steel wire, adjustable in height
- Standard wheels (2 with brake + 2 without brake)
- Removable control panel and motor ventilation grille
- Ventilated condensing unit
- Forced draft system evaporator, with anti-corrosion epoxy coating
- Forced draft fans stop when the door is opened
- Automatic evaporation of defrost water
- Injected polyurethane insulation, density 40 Kg / m³, zero ODP and GWP effects
- Digital temperature control, optimized defrosts, high condensation temperature alarm. Efficient management of energy consumption
- Working temperature: 32 ° C

CARACTÉRISTIQUES TECHNIQUES

- Extérieur en acier sauf le dossier
- Intérieur en acier, avec bords incurvés et fond incrusté
- Portes à ouverture réversible, avec système de fermeture automatique et coupe-froid magnétique (reste ouverte lors d'une ouverture à plus de 90°)
- Double vitrage
- Eclairage intérieur LED
- Étagères intérieures en fil d'acier plastifié, réglables en hauteur
- Roues standard (2 avec frein + 2 sans frein)
- Panneau de commande amovible et grille de ventilation du moteur
- Groupe de condensation ventilé
- Evaporateur à tirage forcé, avec revêtement époxy anti-corrosion
- Les ventilateurs à tirage forcé s'arrêtent lorsque la porte est ouverte
- Évaporation automatique de l'eau de dégivrage
- Isolation en polyuréthane injecté, densité 40 Kg/m³, zéro effets ODP et GWP
- Contrôle digital de la température, dégivrages optimisés, alarme de température de condensation élevée. Gestion efficace de la consommation d'énergie
- Température de fonctionnement : 32°C

Modelo Model Modèle	Largo Length Longueur mm	Alto Height Hauteur mm	Fondo Depth Profondeur mm	Rango Range Gamme	Estantes Shelves Étagères	Capacidad Capacity Exposition L	Voltaje Voltage Tension	Refrig. Coolant Frigorigène	Potencia Frig. Frig Power Puissance Frig. W	Consumo Nominal Nominal Consumption Consommation Nominale W	Rango Range Gamme	clase climate 2015/1094 EN16825 Rango Range Gamme
DUPR-27G	660	2145	845	-2°C 28°F +8°C 46°F	4	645	230V-50Hz	R134a*	245	264	-	4 30°C 55%
	26	847/16	331/4					R290	502	260	C	5 40°C 40%
DUPR-55G	1350	2145	845	-2°C 28°F +8°C 46°F	8+4	1404	230V-50Hz	R452*	452	627	-	4 30°C 55%
	561/16	847/16	331/4					R290	606	560	D	4 30°C 55%
DUPR-82G	2035	2145	845	-2°C 28°F +8°C 46°F	12+8	2197	230V-50Hz	R134a*	485	461	-	4 30°C 55%
	801/8	847/16	331/4					R290	845	396	E	4 30°C 55%
DUPL-27G	660	2145	845	-20°C -4°F -15°C +5°F	4	645	230V-50Hz	R449A*	1042	1010	-	4 30°C 55%
	26	847/16	331/4					R290	907	902	E	4 30°C 55%
DUPL-55G	1350	2145	845	-20°C -4°F -15°C +5°F	8+4	1404	230V-50Hz	R290	1702	943	E	4 30°C 55%
	561/16	847/16	331/4					R449A*	1215	932	-	4 30°C 55%
DUPL-82G	2035	2145	845	-20°C -4°F -15°C +5°F	12+8	2197	230V-50Hz	R290	1814	1726	E	3 25°C 60%
	801/8	847/16	331/4					R449A*	1630	1640	-	4 30°C 55%

OPCIONES - OPTIONS - OPTIONS

encimera con peto	worktop with splash-back	plan de travail avec bavoir	consultar
set 4 patas	set 4 legs	set 4 pattes	0 €
set 6 patas	set 6 legs	set 6 pattes	0 €
respaldo inox	SS rear side	support en acier inoxydable	consultar
tropicalizado 43°C	tropicalized 43 ° C	tropicalisé 43°C	consultar
230V 60Hz / 115V 60Hz	230V 60Hz / 115V 60Hz	230V 60Hz / 115V 60Hz	consultar
cambio R290 por R134a	change R290 for R134a	changer R290 pour R134a	0 €
cambio R290 por R449A	change R290 for R449A	changer R290 pour R449A	0 €



DUPR-27G **2.850 €**
DUPL-27G **3.942 €**



DUPR-55G **4.229 €**
DUPL-55G **5.445 €**



DUPR-82G **5.754 €**
DUPL-82G **7.235 €**

10

GAMA SPEED SPEED GAMMA GAMMA SPEED



VED-8 Página 393
Vitrina expositora refrigerada fondo 800
Refrigerated display case depth 800
Vitrine réfrigérée profondeur 800



VEPD-9 Página 397
Vitrina expositora refrigerada fondo 900
Refrigerated display case depth 900
Vitrine réfrigérée profondeur 900



VED-9 Página 395
Vitrina expositora refrigerada fondo 900
Refrigerated display case depth 900
Vitrine réfrigérée profondeur 900



VED-10 Página 399
Vitrina expositora refrigerada fondo 1000
Refrigerated display case depth 1000
Vitrine réfrigérée profondeur 1000

GAMA ACERO INOXIDABLE / STAINLESS STEEL RANGE

- Modelos **SPEED** Exterior e interior en acero AISI-304
- Modelos **SPEED-F** Exterior e interior en acero AISI-430, excepto fondo interior y contrapuestas en AISI-304

- Models **SPEED** Exterior and interior steel AISI-304
- Models **SPEED-F** Exterior and interior in AISI-430 steel, except storm doors interior and bottom AISI-304



MD Página 401
Mesa fría SNACK
SNACK cold table
Table froide SNACK



ASD-125 Página 413
Armario SNACK 125
SNACK cabinet 125
Armoire SNACK 125



MGD Página 403
Mesa fría gastrorm
Gastrorm cold table
Table froide gastrorm



ASD-140 Página 415
Armario SNACK 140
SNACK cabinet 140
Armoire SNACK 140



FD Página 405
Contra mostrador
Against counter
Contre contre



AGD-50 Página 417
Armario gastrorm 50
Gastrorm cabinet 50
Armoire gastrorm 50



ED/MCD Página 407
Mesa cafetera y estantería
Coffee table and shelf
Table basse et étagère



AGD-75 Página 419
Armario gastrorm 75
Gastrorm cabinet 75
Armoire gastrorm 75



ASD-55 Página 409
Armario SNACK 55
SNACK cabinet 55
Armoire SNACK 55



AGD-140 Página 421
Armario gastrorm 140
Gastrorm cabinet 140
Armoire gastrorm 140



ASD-75 Página 411
Armario SNACK 75
SNACK cabinet 75
Armoire SNACK 75

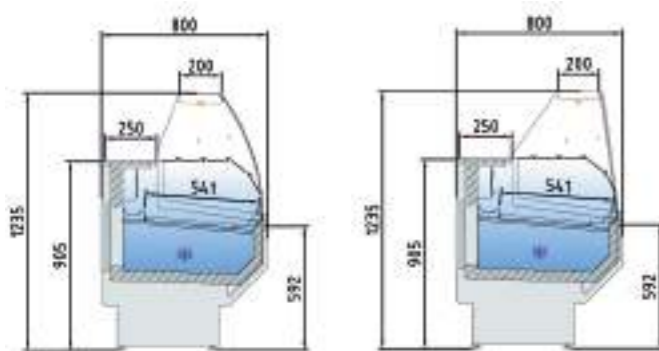

VED-8-C

VED-8-R



Vista trasera
Rear view
Vue arrière



VED-8-15-R



VED-8-25-C

Laterales incluidos en PVP / Sides included in PVP / Latéraux inclus dans PVP

CARACTERÍSTICAS TÉCNICAS

- Decoración inferior y costados en gris RAL 7024
- Interior en chapa de acero prepintada
- Plano exposición y protección evaporador en chapa acabado epoxi
- Costados de 30 mm en ABS inyectado
- Encimera en acero inox.
- Perfilería en aluminio anodizado
- Estante de cristal intermedio iluminado, opcional
- Cristal frontal templado y abatible, dos versiones disponibles
- Iluminación estándar LED: encimera superior
- Aislamiento de poliuretano inyectado, densidad 40 Kg/m³, bajo GWP y cero efecto ODP
- Reserva refrigerada con puertas, hueco 440x270
- Evaporador estático
- Condensación ventilada
- Control electrónico de temperatura
- Descarcho automático
- Clase climática 4 (30°C 55% Hr) régimen M1 según UNE-EN ISO 23953-2
- Chasis en acero acabado epoxi
- Evaporación automática de serie

TECHNICAL DATA

- Lower decoration and sides in gray RAL 7024
- Interior steel sheet prepainted
- Exposure and protection evaporator in epoxy finish plate
- Sides ABS injected, 30 mm thickness
- Worktop in stainless steel
- Anodized aluminum profiles
- Lighting intermediate glass shelf, optional
- Toughened curved glass hinges forward, two versions available
- Lighting Standard LED on top surface
- Isolation of polyurethane, density 40 Kg / m³, low GWP and zero ODP effect
- Refrigerated under storage with doors 440x270free,
- Static evaporator
- Condensation ventilated
- Electronic temperature control
- Automatic Defrost
- Climatic class 4 (30 ° C 55% Hr) regime M1 according to UNE-EN ISO 23953-2
- Automatic evaporation as standard
- Chassis in epoxy finished steel

CARACTÉRISTIQUES TECHNIQUES

- Décoration inférieure et côtés en gris RAL 7024
- Intérieur en tôle d'acier prépeinte
- Plan d'exposition et protection de l'évaporateur en tôle, finition epoxi
- Côtés de 30mm en ABS injecté
- Plan de travail en acier inox.
- Profils en aluminium anodisé
- Etagère intermédiaire en verre iluminé, sur option
- Vitre frontale rabattable en verre trempé, deux versions disponibles.
- Eclairage standard LED : Plan de travail supérieur.
- Isolation en polyuréthane injecté, densité de 40 Kg / m³, faible GWP et aucun effet ODP.
- Réserve réfrigérée avec portes, espace de 440x270
- Evaporateur statique
- Condensateur ventilé
- Contrôle électronique de température
- Dégivrage automatique
- Clase climática 4 (30 ° C 55% Hr) régime M1 selon UNE-EN ISO 23953-2
- Évaporation automatique en standard
- Châssis en acier fini époxy

Modelo Model Modèle	Largo Length Longueur	Superficie de exposición Display Surface d'exposition	Superficie total de exposición (TDA) Total display area Surface totale de l'exposition		Cámara Storage Stockage	Puertas Doors Portes	Potencia frigorífica Cooling capacity Puissance frigorifique	Consumo Nominal Nominal Power Consommation Nominale	Refrigerante Coolant Réfrigérant
			R	C					
VED-8-10	1025	0,68	0,48	0,48	246	1	565	826	R-290
VED-8-13	1265	0,85	0,60	0,60	309	2	572	881	R-290
VED-8-15	1505	1,01	0,72	0,72	373	2	781	1000	R-290
VED-8-20	1985	1,35	0,95	0,95	499	3	949	1085	R-290
VED-8-25	2465	1,69	1,19	1,19	626	4	1284	1278	R-290
VED-8-30	2945	2,03	1,43	1,43	752	4	1284	1299	R-290

230v 60Hz / 115v 60Hz. consultar - consult - consulter

*Modelos en HFC, consultar precio / HFC Models, consult prices / Modèles HFC, consulter prix

COLORES DECORACIÓN STANDARD / COLORS STANDARD DECORATION / COULEURS POUR LA DÉCORER STANDARD

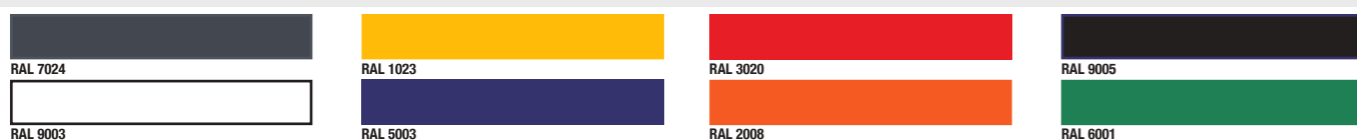

PVP de opcionales incluidos en equipo, no como repuesto / PVP of options included in the equipment, not as a spare part / PVP d'options incluses dans l'équipement, pas en tant que pièce de rechange

OPCIONES · OPTIONS · OPTIONS

Modelo Model Modèle	Estante cristal iluminado Lighting glass shelf Etagère en verre illuminé	Plano de exposición en acero Stainless steel exposure Surface d'exposition en inox	Cierre plexi Plexi slide Kit vitrage plexi
VED-8-10	179 €	198 €	118 €
VED-8-13	228 €	240 €	173 €
VED-8-15	267 €	272 €	201 €
VED-8-20	360 €	304 €	252 €
VED-8-25	450 €	366 €	335 €
VED-8-30	506 €	431 €	397 €

Características técnicas y constructivas sujetas a variación sin previo aviso. / We reserve the right to change specifications without prior notice. / Sujet technique et la conception de modifications sans préavis.

VED-8-10-R 1.978 €	VED-8-13-R 2.100 €	VED-8-15-R 2.369 €	VED-8-20-R 2.699 €	VED-8-25-R 3.080 €	VED-8-30-R 3.546 €
VED-8-10-C 2.048 €	VED-8-13-C 2.122 €	VED-8-15-C 2.405 €	VED-8-20-C 2.641 €	VED-8-25-C 3.147 €	VED-8-30-C 3.580 €

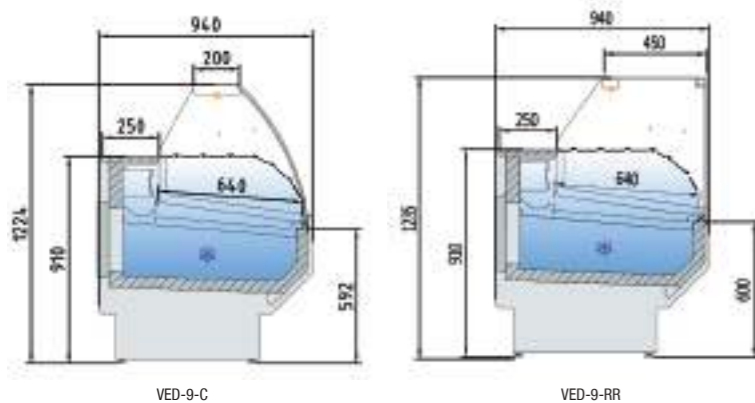

CARACTERÍSTICAS TÉCNICAS

- Decoración inferior y costados en gris RAL 7024
- Interior en chapa de acero prepintada
- Plano exposición y protección evaporador en chapa acabado epoxy
- Costados de 30 mm en ABS inyectado
- Encimera en acero inox
- Perfilería en aluminio lacado
- Estante de cristal intermedio, opcional
- Cristal frontal templado y abatible, dos versiones disponibles
- Iluminación estándar LED: encimera superior
- Aislamiento de poliuretano inyectado, densidad 40 Kg/m³, bajo GWP y cero efecto ODP
- Reserva refrigerada con puertas, hueco 440x270 (solo modelo VED)
- Evaporación estática
- Condensación ventilada
- Control electrónico de temperatura
- Descarche automático
- Clase climática 4 (30°C 55% Hr) régimen M1 según UNE-EN ISO 23953-2
- Chasis en acero acabado epoxy
- Evaporación automática de serie

TECHNICAL DATA

- Lower decoration and sides in gray RAL 7024
- Interior steel sheet prepainted
- Exposure and protection evaporator in epoxy finish plate
- Sides ABS injected, 30 mm thickness
- Worktop in stainless steel
- Lacquered aluminum profiles
- Intermediate glass shelf, optional
- Toughened curved glass hinges forward, two versions available
- Lighting Standard LED on top surface
- Isolation of polyurethane, density 40 Kg / m³, low GWP and zero ODP effect
- Refrigerated under storage with doors 440x270 (only model VED)
- Static evaporation
- Condensation ventilated
- Electronic temperature control
- Automatic Defrost
- Climatic class 4 (30 ° C 55% Hr) regime M1 according to UNE-EN ISO 23953-2
- Automatic evaporation as standard
- Chassis in epoxy finished steel

CARACTÉRISTIQUES TECHNIQUES

- Décoration inférieure et côtés en gris RAL 7024
- Intérieur en tôle d'acier prépeinte
- Extérieur et intérieur en tôle d'acier prépeinte
- Plan d'exposition et protection de l'évaporateur en tôle, finition epoxy
- Côtés de 30mm en ABS injecté
- Plan de travail en acier inox
- Profilés en aluminium laqué
- Etagère intermédiaire en verre sur option
- Vitre frontale rabattable en verre trempé, deux versions disponibles.
- Eclairage standard LED: Plan de travail supérieur.
- Isolation en polyuréthane injecté, densité de 40 Kg / m³, faible GWP et aucun effet ODP.
- Réserve réfrigérée avec portes, espace de 440x270 (solo modelé VED)
- Évaporation statique
- Condensateur ventilé
- Contrôle électronique de température
- Dégivrage automatique
- Classe climatique 4 (30 ° C 55% Hr) régime M1 selon UNE-EN ISO 23953-2
- Évaporation automatique en standard
- Châssis en acier fini époxy

Modelo Model Modèle	Largo Length Longueur	Superficie de exposición Display Surface d'exposition	Superficie total de exposición (TDA) Total display area Surface totale de l'exposition		Cámara Storage Stockage	Puertas Doors Portes	Potencia frigorífica Cooling capacity Puissance frigorifique	Consumo Nominal Nominal Power Consommation Nominale	Refrigerante Coolant Réfrigérant
			RR	C					
VED-9-10	1025	0,77	0,62	0,62	299	1	483	823	R-290
VED-9-13	1265	0,96	0,78	0,78	376	2	572	881	R-290
VED-9-15	1505	1,15	0,93	0,93	452	2	781	1000	R-290
VED-9-20	1985	1,54	1,24	1,24	606	3	1098	1219	R-290
VED-9-25	2465	1,92	1,55	1,55	759	4	1284	1278	R-290
VED-9-30	2945	2,30	1,86	1,86	913	4	1284	1299	R-290

*Modelos en HFC, consultar precio / HFC Models, consult prices / Modèles HFC, consulter prix
230v 60Hz / 115v 60Hz. consultar - consult - consulter

COLORES DECORACIÓN STANDARD / COLORS STANDARD DECORATION / COULEURS POUR LA DÉCORER STANDARD

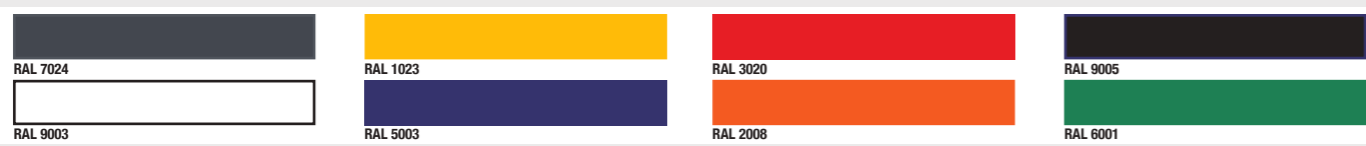

PVP de opcionales incluidos en equipo, no como repuesto / PVP of options included in the equipment, not as a spare part / PVP d'options incluses dans l'équipement, pas en tant que pièce de rechange

OPCIONES · OPTIONS · OPTIONS

Modelo Model Modèle	Estante cristal iluminado Lighting glass shelf Etagère en verre illuminé	Plano de exposición en acero Stainless steel exposure Surface d'exposition en inox	Cierre plexi Plexi slide Kit vitrage plexi
VED-9-10	179 €	198 €	118 €
VED-9-13	228 €	240 €	173 €
VED-9-15	267 €	272 €	201 €
VED-9-20	360 €	304 €	252 €
VED-9-25	450 €	366 €	335 €
VED-9-30	506 €	431 €	397 €

Características técnicas y constructivas sujetas a variación sin previo aviso. / We reserve the right to change specifications without prior notice. / Sujet technique et la conception de modifications sans préavis.

Laterales incluidos en PVP / Sides included in PVP / Latéraux inclus dans PVP

VED-9-10-RR 1.993 €	VED-9-13-RR 2.220 €	VED-9-15-RR 2.482 €	VED-9-20-RR 2.695 €	VED-9-25-RR 3.208 €	VED-9-30-RR 3.679 €
VED-9-10-C 1.993 €	VED-9-13-C 2.220 €	VED-9-15-C 2.482 €	VED-9-20-C 2.695 €	VED-9-25-C 3.208 €	VED-9-30-C 3.679 €

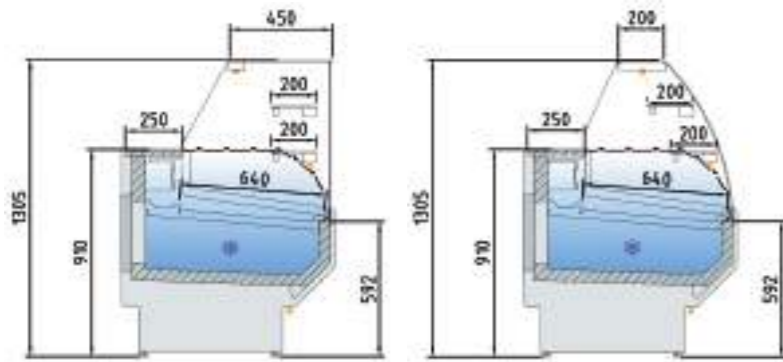

VEPD-9-RR

VEPD-9-C

CARACTERÍSTICAS TÉCNICAS

- Exterior e interior en chapa de acero prepintada
- Plano exposición y protección evaporador en acero inox
- Costados de 30 mm en poliestireno inyectado
- Encimera en acero inox
- Perfilera en aluminio anodizado
- Acabado exterior de serie: lacado o plastificado simil madera
- Dos estantes de cristal
- Cristal frontal templado y abatible, dos versiones disponibles
- Iluminación estándar LEDS: encimera superior, estantes y frente exterior
- Aislamiento de poliuretano inyectado, densidad 40 Kg/m³, bajo GWP y cero efecto ODP
- Reserva refrigerada con puertas, hueco 440x270
- Evaporador estático
- Condensación ventilada
- Control electrónico de temperatura
- Descarche automático
- Clase climática 4 (30°C 55%HR) régimen M1 según UNE-EN ISO 23953-2
- Chasis en acero acabado epoxi
- Evaporación automática de serie

TECHNICAL DATA

- Exterior and interior steel sheet prepainted
- Exposure and protection evaporator in stainless steel
- Sides polystyrene injected, 30 mm thickness
- Worktop in stainless steel
- Anodized aluminum profiles
- Exterior finish as standard: lacquered or laminated wood simil
- Two glass shelves
- Toughened curved glass hinges forward, two versions available
- Standard LED Lighting: counter top, bottom shelf and outer front
- Isolation of polyurethane, density 40 Kg / m³, low GWP and zero ODP effect
- Refrigerated under storage with doors 440x270free,
- Static evaporator
- Condensation ventilated
- Electronic temperature control
- Automatic Defrost
- Climatic class 4 (30 ° C 55% Hr) regime M1 according to UNE-EN ISO 23953-2
- Automatic evaporation as standard
- Chassis in epoxy finished steel

CARACTÉRISTIQUES TECHNIQUES

- Extérieur et intérieur en tôle d'acier prépeinte
- Plan d'exposition et protection de l'évaporateur en tôle, finition acier
- Côtés de 30mm en polystyrène injecté
- Plan de travail en acier inox
- Profils en aluminium anodisé
- Finition extérieure de série: laqué ou plastifié, imitation «bois»
- Deux étagères en verre
- Vitre frontale rabattable en verre trempé, deux versions disponibles.
- Eclairage standard LED : Plan de travail supérieur, étagère et sur l'extérieure de la partie avant.
- Isolation en polyuréthane injecté, densité de 40 Kg / m³, faible GWP et aucun effet ODP.
- Réserve réfrigérée avec portes, espace de 440x270
- Evaporateur statique
- Condensateur ventilé
- Contrôle électronique de température
- Dégivrage automatique
- Classe climatique 3 (25 ° C 60% HR) régime M1
- Classe climatique 4 (30 ° C 55% Hr) régime M1 selon UNE-EN ISO 23953-2
- Evaporation automatique en standard
- Châssis en acier fini époxy



VEPD-9-20-C



VEPD-9-25-RR

Laterales incluidos en PVP / Sides included in PVP / Latéraux inclus dans PVP

Modelo Model Modèle	Largo Length Longueur	Superficie de exposición Display Surface d'exposition	Superficie total de exposición (TDA) Total display area Surface totale de l'exposition		Cámara Storage Stockage	Puertas Doors Portes	Potencia frigorífica Cooling capacity Puissance frigorifique	Consumo Nominal Nominal Power Consommation Nominale	Refrigerante Coolant Réfrigérant
	(mm)	(m²)	C	RR	(Its.)	(Uds)	(W)	(W)	
VEPD-9-10	1025	0,96	0,62	0,76	299	1	483	837	R-290
VEPD-9-13	1265	1,20	0,78	0,95	376	2	572	901	R-290
VEPD-9-15	1505	1,44	0,93	1,14	452	2	781	1023	R-290
VEPD-9-20	1985	1,92	1,24	1,52	606	3	1098	1248	R-290
VEPD-9-25	2465	2,40	1,55	1,90	759	4	1284	1318	R-290
VEPD-9-30	2945	2,88	1,86	2,28	913	4	1284	1345	R-290

230v 60Hz / 115v 60Hz. consultar - consult - consulter

COLORES DECORACIÓN STANDARD / COLORS STANDARD DECORATION / COULEURS POUR LA DÉCORER STANDARD

Colores decoración simil madera - colors wood simil - Couleur de décoration « imitation bois »

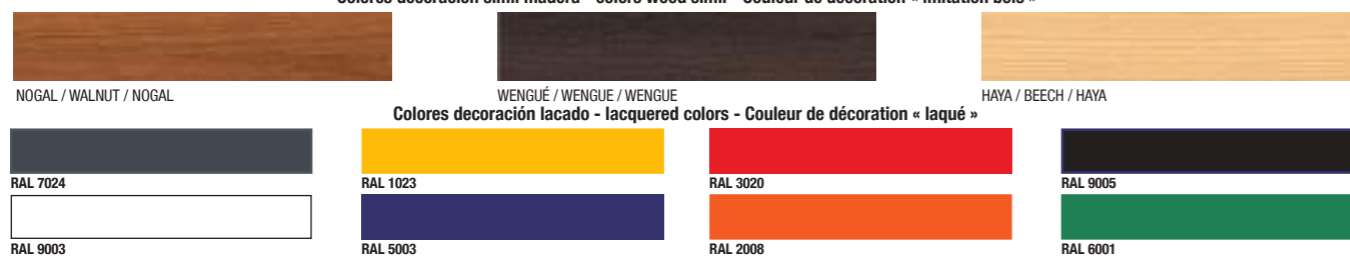

PVP de opcionales incluidos en equipo, no como repuesto / PVP of options included in the equipment, not as a spare part / PVP d'options incluses dans l'équipement, pas en tant que pièce de rechange

OPCIONES - OPTIONS - OPTIONS

Modelo Model Modèle	Cierre plexi Plexi slide Kit vitrage plexi
VEPD-9-10	118 €
VEPD-9-13	173 €
VEPD-9-15	201 €
VEPD-9-20	252 €
VEPD-9-25	335 €
VEPD-9-30	397 €



Características técnicas y constructivas sujetas a variación sin previo aviso. / We reserve the right to change specifications without prior notice. / Sujet technique et la conception de modifications sans préavis.

VEPD-9-10-RR 2.436 €	VEPD-9-13-RR 2.945 €	VEPD-9-15-RR 3.243 €	VEPD-9-20-RR 3.683 €	VEPD-9-25-RR 4.414 €	VEPD-9-30-RR 5.055 €
VEPD-9-10-C 2.392 €	VEPD-9-13-C 2.886 €	VEPD-9-15-C 3.215 €	VEPD-9-20-C 3.666 €	VEPD-9-25-C 4.375 €	VEPD-9-30-C 5.006 €

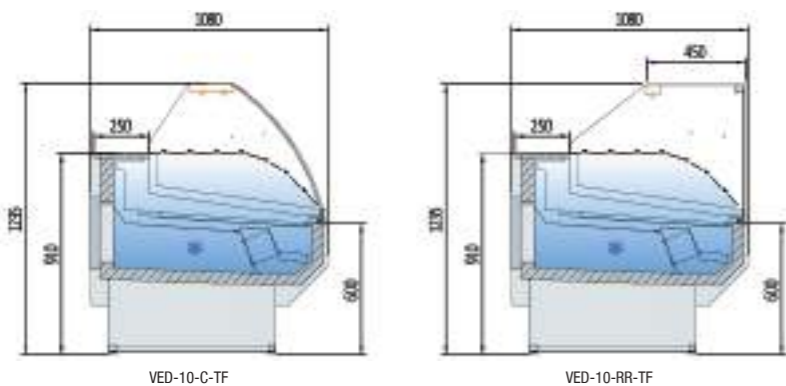

VED-10-15-C-TF



VED-10-20-RR-TF

Laterales incluidos en PVP / Sides included in PVP / Latéraux inclus dans PVP

CARACTERÍSTICAS TÉCNICAS

- Decoración inferior y costados en gris RAL 7024
- Interior en chapa de acero prepintada
- Plano exposición y protección evaporador en chapa acabado epoxi
- Costados de 30 mm en ABS inyectado
- Encimera en acero inox
- Perfilera en aluminio lacado
- Estante de cristal intermedio, opcional
- Cristal frontal templado y abatible, dos versiones disponibles
- Iluminación estándar LED: encimera superior
- Aislamiento de poliuretano inyectado, densidad 40 Kg/m³, bajo GWP y cero efecto ODP
- Reserva refrigerada con puertas, hueco 440x270
- Evaporación ventilada
- Condensación ventilada
- Control electrónico de temperatura
- Descarche automático
- Clase climática 4 (30°C 55% Hr) régimen M1 según UNE-EN ISO 23953-2
- Chasis en acero acabado epoxi
- Evaporación automática de serie

TECHNICAL DATA

- Lower decoration and sides in gray RAL 7024
- Interior steel sheet prepainted
- Exposure and protection evaporator in epoxy finish plate
- Sides ABS injected, 30 mm thickness
- Worktop in stainless steel
- Lacquered aluminum profiles
- Intermediate glass shelf, optional
- Toughened curved glass hinges forward, two versions available
- Lighting Standard LED on top surface
- Isolation of polyurethane, density 40 Kg / m³, low GWP and zero ODP effect
- Refrigerated under storage with doors 440x270
- Ventilated evaporation
- Condensation ventilated
- Electronic temperature control
- Automatic Defrost
- Climatic class 4 (30 ° C 55% Hr) regime M1 according to UNE-EN ISO 23953-2
- Automatic evaporation as standard
- Chassis in epoxy finished steel

CARACTÉRISTIQUES TECHNIQUES

- Décoration inférieure et côtés en gris RAL 7024
- Intérieur en tôle d'acier prépeinte
- Plan d'exposition et protection de l'évaporateur en tôle, finition epoxi
- Côtés de 30mm en ABS injecté
- Plan de travail en acier inox
- Profils en aluminium laqué
- Etagère intermédiaire en verre sur option
- Vitre frontale rabattable en verre trempé, deux versions disponibles.
- Éclairage standard LED: Plan de travail supérieur.
- Isolation en polyuréthane injecté, densité de 40 Kg / m³, faible GWP et aucun effet ODP.
- Réserve réfrigérée avec portes, espace de 440x270
- Évaporation ventilé
- Condensateur ventilé
- Contrôle électronique de température
- Dégivrage automatique
- Classe climatique 4 (30 ° C 55% Hr) régime M1 selon UNE-EN ISO 23953-2
- Évaporation automatique en standard
- Châssis en acier fini époxy

Modelo Model Modèle	Largo Length Longueur	Superficie de exposición Display Surface d'exposition	Superficie total de exposición (TDA) Total display area Surface totale de l'exposition	Cámara Storage Stockage	Puertas Doors Portes	Potencia frigorífica Cooling capacity Puissance frigorifique	Consumo Nominal Nominal Power Consommation Nominale	Refrigerante Coolant Réfrigérant
	(mm)	(m²)	C	(lts)	(Uds)	(W)	(W)	
VED-10-10-TF	1025	0,80	0,77	293	1	483	844	R-290
VED-10-13-TF	1265	1,00	0,96	369	2	572	902	R-290
VED-10-15-TF	1505	1,21	1,15	444	2	781	1035	R-290
VED-10-20-TF	1985	1,61	1,53	594	3	1098	1275	R-290
VED-10-25-TF	2465	2,01	1,91	745	4	1284	1334	R-290
VED-10-30-TF	2945	2,41	2,29	896	4	1284	1355	R-290

230v 60Hz / 115v 60Hz. consultar - consult - consulter

COLORES DECORACIÓN STANDARD / COLORS STANDARD DECORATION / COULEURS POUR LA DÉCORER STANDARD

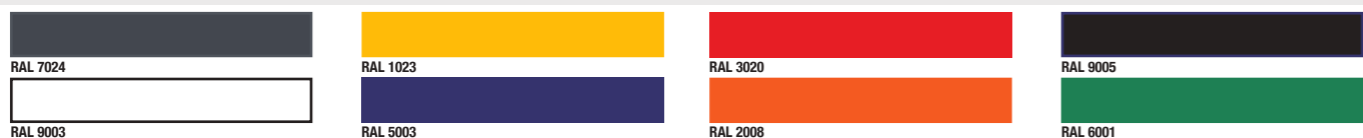

PVP de opcionales incluidos en equipo, no como repuesto / PVP of options included in the equipment, not as a spare part / PVP d'options incluses dans l'équipement, pas en tant que pièce de rechange

OPCIONES · OPTIONS · OPTIONS

Modelo Model Modèle	Estante cristal iluminado Lighting glass shelf Etagère en verre illuminé	Plano de exposición en acero Stainless steel exposure Surface d'exposition en inox	Cierre plexi Plexi slide Kit vitrage plexi
VED-10-10-TF	179 €	198 €	118 €
VED-10-13-TF	228 €	240 €	173 €
VED-10-15-TF	267 €	272 €	201 €
VED-10-20-TF	360 €	304 €	252 €
VED-10-25-TF	450 €	366 €	335 €
VED-10-30-TF	506 €	431 €	397 €

Características técnicas y constructivas sujetas a variación sin previo aviso. / We reserve the right to change specifications without prior notice. / Sujet technique et la conception de modifications sans préavis.

VED-10-10-RR-TF 2.631 €	VED-10-13-RR-TF 2.911 €	VED-10-15-RR-TF 3.293 €	VED-10-20-RR-TF 3.688 €	VED-10-25-RR-TF 4.300 €	VED-10-30-RR-TF 5.197 €
VED-10-10-C-TF 2.631 €	VED-10-13-C-TF 2.911 €	VED-10-15-C-TF 3.293 €	VED-10-20-C-TF 3.688 €	VED-10-25-C-TF 4.300 €	VED-10-30-C-TF 5.197 €

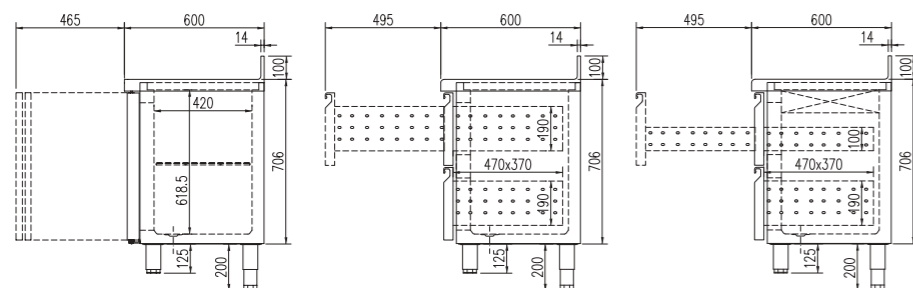

MD-200

CARACTERÍSTICAS TÉCNICAS

- Exterior e interior en acero AISI-304
- Puertas de apertura reversible, con sistema de cierre automático y burlete magnético (permanece abierta al superar los 90° de apertura)
- Encimera con peto trasero sanitario de 100 mm
- Estantes interiores de alambre en acero plastificado, regulables en altura
- Pies en tubo de acero inox ajustables en altura 125-200 mm
- Unidad condensadora ventilada y extraíble
- Evaporador sistema tiro forzado, con recubrimiento anticorrosión
- Evaporación automática del agua de descarche
- Aislamiento de poliuretano inyectado, densidad 40 Kg/m³, bajo GWP y cero efecto ODP
- Control digital de temperatura y descarches, eficiente en la gestión del consumo de energía
- Temperatura de trabajo a 32°C ambiente
- Luz interior solo en modelos con puertas de cristal

TECHNICAL DATA

- Exterior and interior steel AISI-304
- Doors with self closing system, blocked opening, magnetic gasket and possibility of changing the opening sense
- Worktop, with 100 mm sanitary upstand
- Shelves made of plasticized steel wire, height adjustable
- Stainless steel adjustable legs, 125 to 200 mm
- Removable and fan assisted condenser unit
- Fan assisted evaporator, with anticorrosion coating.
- Automatic evaporation of defrost water
- 40 Kg/m³ density polyurethane insulation, low GWP and zero ODP effect
- Energy efficient digital controller of temperature and defrosts
- Operating temperature 32°C ambient
- Interior light only on models with glass doors

CARACTÉRISTIQUES TECHNIQUES

- Extérieur et intérieur en acier AISI-304
- Ouverture des portes réversibles avec système de fermeture automatique avec joint magnétique (la porte se maintient ouverte lorsque l'angle dépasse les 90° à l'ouverture)
- Plan de travail avec panneau de protection sanitaire de 100mm
- Étagères intérieures avec grilles en acier plastifié, réglables en hauteur.
- Pieds en tube d'acier inoxydables, réglables en hauteur 125-200mm
- Condensateur ventilé et extractible.
- Évaporateur avec système à marche forcée et recouvrement anticorrosion.
- Évaporation automatique de l'eau de dégivrage.
- Isolation en polyuréthane injecté, densité de 40 Kg / m³, faible GWP et aucun effet ODP.
- Le Contrôle digital de température ainsi que le dégivrage automatique œuvre à une meilleure gestion de la consommation énergétique.
- Température de travail à 32°C ambiant
- Éclairage intérieur que sur les modèles avec portes en verre



Modelo Model Modèle	Largo Length Longueur mm	Alto Height Hauteur mm	Fondo Depth Profondeur mm	Rango Range Gamme	Estantes Shelves Étagères	Capacidad Capacity Exposition L	Voltaje Voltage Tension	Refrig. Coolant Frigorigène	Potencia Frig. Frig Power Puissance Frig. W	Consumo Nominal Nominal Consumption Consommation Nominale W	Rango Range Gamme	clase climate 2015/1094 EN16825
MD-150	1495	850	600	-2°C +8°C	2	245	230 V - 50 Hz	R-290	502	235	B	5 (40°C 40%)
MVD-150	1495	850	600	-2°C +8°C	2	245	230 V - 50 Hz	R-290	502	244	-	5 (40°C 40%)
MD-200	2020	850	600	-2°C +8°C	3	380	230 V - 50 Hz	R-290	502	238	B	5 (40°C 40%)
MVD-200	2020	850	600	-2°C +8°C	3	380	230 V - 50 Hz	R-290	502	251	-	5 (40°C 40%)
MD-250	2545	850	600	-2°C +8°C	4	516	230 V - 50 Hz	R-290	845	379	C	5 (40°C 40%)
MVD-250	2545	850	600	-2°C +8°C	4	516	230 V - 50 Hz	R-290	845	397	-	5 (40°C 40%)
MND-150	1495	850	600	-20°C -15°C	2	245	230 V - 50 Hz	R-290	606	535	E	5 (40°C 40%)
MND-200	2020	850	600	-20°C -15°C	3	380	230 V - 50 Hz	R-290	606	556	E	4 (30°C 55%)

OPCIONES · OPTIONS · OPTIONS

Parrilla adicional	Extra shelf	Grille additionnelle	24 € x ud
Incremento precio por cambio de puerta a cajonera	Increase of price by changing door to double drawers	Augmenter le prix pour le changement de porte en commode	341 € x set
Set 4 ruedas	4 Castors set	Jeu 4 roulettes	98 € x set
Set 6 ruedas	6 Castors set	Jeu 6 roulettes	146 € x set
230V 60hz / 115v 60hz	230V 60hz / 115v 60hz	230V 60hz / 115v 60hz	consultar - consult - consulter

*Modelos en HFC, consultar precio / HFC Models, consult prices / Modèles HFC, consulter prix

Características técnicas y constructivas sujetas a variación sin previo aviso. / We reserve the right to change specifications without prior notice. / Sujet technique et la conception de modifications sans préavis.



MD-200



LED



MVD-200

MD-150 1.986 €	MD-200 2.309 €	MD-250 2.742 €
MND-150 2.411 €	MND-200 2.813 €	MND-250 -
MVD-150 2.096 €	MVD-200 2.511 €	MVD-250 3.017 €

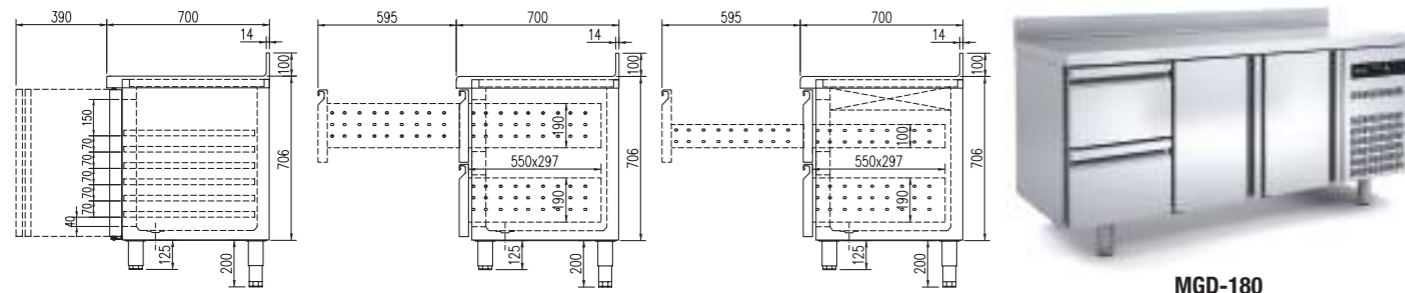

MGD-180



MGD-135

CARACTERÍSTICAS TÉCNICAS	TECHNICAL DATA	CARACTÉRISTIQUES TECHNIQUES
<ul style="list-style-type: none"> Modelos SPEED Exterior e interior en acero AISI-304 Modelos SPEED-F Exterior e interior en acero AISI-430, excepto fondo interior y contraportas en AISI-304 Puertas de apertura reversible, con sistema de cierre automático y burlete magnético (permanece abierta al superar los 90° de apertura) Encimera con peto trasero sanitario de 100 mm Estantes interiores GN 1/1 de alambre en acero plastificado, regulables en altura sobre guías inox Pies en tubo de acero inox ajustables en altura 125-200 mm Unidad condensadora ventilada y extraíble Evaporador sistema tiro forzado, con recubrimiento anticorrosión Evaporación automática del agua de descarche Aislamiento de poliuretano inyectado, densidad 40 Kg/m³, bajo GWP y cero efecto ODP Control digital de temperatura y descarches, eficiente en la gestión del consumo de energía Temperatura de trabajo a 32°C ambiente Luz interior solo en modelos con puertas de cristal 	<ul style="list-style-type: none"> Models SPEED Exterior and interior steel AISI-304 Models SPEED-F Exterior and interior in AISI-430 steel, except storm doors interior and bottom AISI-304 Doors with self closing system, blocked opening, magnetic gasket and possibility of changing the opening sense Worktop, with 100 mm sanitary upstand GN 1/1 shelves made of plasticized steel wire, height adjustable with stainless steel slides Stainless steel adjustable legs, 125 to 200 mm Removable and fan assisted condenser unit Fan assisted evaporator, with anticorrosion coating. Automatic evaporation of defrost water 40 Kg/m³ density polyurethane insulation, low GWP and zero ODP effect Energy efficient digital controller of temperature and defrosts Operating temperature 32°C ambient Interior light only on models with glass doors 	<ul style="list-style-type: none"> Modèles SPEED Extérieur et intérieur en acier AISI-304 Modèles SPEED-F Extérieur et intérieur en acier AISI-430, sauf contre-portes intérieure et inférieure AISI-304 Ouverture des portes réversibles avec système de fermeture automatique avec joint magnétique (la porte se maintient ouverte lorsque l'angle dépasse les 90° à l'ouverture) Plan de travail avec panneau de protection sanitaire de 100mm Étagères intérieures avec grilles en acier plastifié, réglables en hauteur. Pieds en tube d'acier inoxydables, réglables en hauteur 125-200mm Condensateur ventilé et extractible. Évaporateur avec système à marche forcée et recouvrement anticorrosion. Évaporation automatique de l'eau de dégivrage. Isolation en polyuréthane injecté, densité de 40 Kg / m³, faible GWP et aucun effet ODP. Le Contrôle digital de température ainsi que le dégivrage automatique œuvre à une meilleure gestion de la consommation énergétique. Température de travail à 32°C ambiant Éclairage intérieur que sur les modèles avec portes en verre



MGVD-135

Modelo Modèle	Largo Longueur mm	Alto Height mm	Fondo Depth Profondeur mm	Rango Range Gamme	Estantes Shelves Étagères	Pares de guías Sets of slides Kit de guides	Capacidad Capacity Exposition L	Voltaje Voltage Tension	Refrig. Coolant Frigorigène	Potencia Frig. Frig Power Puissance Frig. W	Consumo Nominal Nominal Consumption Consommation Nominale W	Rango Range Gamme	clase climate 2015/1094 EN16825
MGD-135	1345	850	700	-2°C +8°C	2	2	255	230 V - 50 Hz	R-290	502	235	B	5 (40°C 40%)
MGVD-135	1345	850	700	-2°C +8°C	2	2	255	230 V - 50 Hz	R-290	502	241	-	5 (40°C 40%)
MGD-180	1795	850	700	-2°C +8°C	3	3	399	230 V - 50 Hz	R-290	502	238	B	5 (40°C 40%)
MGVD-180	1795	850	700	-2°C +8°C	3	3	399	230 V - 50 Hz	R-290	502	267	-	5 (40°C 40%)
MGD-225	2245	850	700	-2°C +8°C	4	4	543	230 V - 50 Hz	R-290	845	379	C	5 (40°C 40%)
MGVD-225	2245	850	700	-2°C +8°C	4	4	543	230 V - 50 Hz	R-290	845	397	-	5 (40°C 40%)
MGND-135	1345	850	700	-20°C -15°C	2	2	255	230 V - 50 Hz	R-290	606	535	E	5 (40°C 40%)
MGND-180	1795	850	700	-20°C -15°C	3	3	399	230 V - 50 Hz	R-290	606	556	D	4 (30°C 55%)

OPCIONES · OPTIONS · OPTIONS			
Parrilla adicional GN 1/1	GN 1/1 Extra shelf	Grille additionnelle GN 1/1	20 € x ud
Set adicional guías GN 1/1	GN 1/1 sides extra shelf	Kit supplémentaire de guides GN 1/1	28 € x ud
Incremento precio por cambio de puerta a cajonera	Increase of price by changing door to double drawers	Augmenter le prix pour le changement de porte en commode	375 € x ud
Set 4 ruedas	4 Castors set	Jeu 4 roulettes	93 € x set
Set 6 ruedas	6 Castors set	Jeu 6 roulettes	139 € x set
230V 60hz / 115v 60hz	230V 60hz / 115v 60hz	230V 60hz / 115v 60hz	consultar - consult - consulter

*Modelos en HFC, consultar precio / HFC Models, consult prices / Modèles HFC, consulter prix
Características técnicas y constructivas sujetas a variación sin previo aviso. / We reserve the right to change specifications without prior notice. / Sujet technique et la conception de modifications sans préavis.

<p>MGD-135 2.118 €</p> <p>MGND-135 2.773 €</p>	<p>MGD-180 2.480 €</p> <p>MGND-180 3.205 €</p>	<p>MGD-225 2.942 €</p> <p>MGND-225 4.472 €</p>
<p>MGD-135-F 1.928 €</p> <p>MGND-135-F 2.524 €</p>	<p>MGD-180-F 2.257 €</p> <p>MGND-180-F 2.917 €</p>	
<p>MGVD-135 2.219 €</p>	<p>MGVD-180 2.697 €</p>	<p>MGVD-225 3.209 €</p>

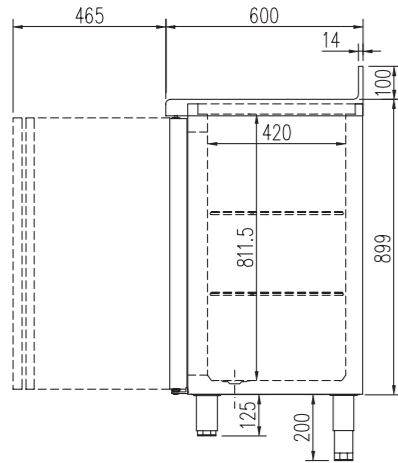

FD-200



LED

FVD-200

CARACTERÍSTICAS TÉCNICAS

- Exterior e interior en acero AISI-304
- Puertas de apertura reversible, con sistema de cierre automático y burlete magnético (permanece abierta al superar los 90° de apertura)
- Encimera con peto trasero sanitario de 100 mm
- Estantes interiores GN 1/1 de alambre en acero plastificado, regulables en altura sobre guías inox
- Pies en tubo de acero inox ajustables en altura 125-200 mm
- Unidad condensadora ventilada y extraíble
- Evaporador sistema tiro forzado, con recubrimiento anticorrosión
- Evaporación automática del agua de descarche
- Aislamiento de poliuretano inyectado, densidad 40 Kg/m³, bajo GWP y cero efecto ODP
- Control digital de temperatura y descarches, eficiente en la gestión del consumo de energía
- Temperatura de trabajo a 32°C ambiente
- Luz interior solo en modelos con puertas de cristal

TECHNICAL DATA

- Exterior and interior steel AISI-304
- Doors with self closing system, blocked opening, magnetic gasket and possibility of changing the opening sense
- Worktop, with 100 mm sanitary upstand
- GN 1/1 shelves made of plasticized steel wire, height adjustable with stainless steel slides
- Stainless steel adjustable legs, 125 to 200 mm
- Removable and fan assisted condenser unit
- Fan assisted evaporator, with anticorrosion coating.
- Automatic evaporation of defrost water
- 40 Kg/m³ density polyurethane insulation, low GWP and zero ODP effect
- Energy efficient digital controller of temperature and defrosts
- Operating temperature 32°C ambient
- Interior light only on models with glass doors

CARACTÉRISTIQUES TECHNIQUES

- Extérieur et intérieur en acier AISI-304
- Ouverture des portes réversibles avec système de fermeture automatique avec joint magnétique (la porte se maintient ouverte lorsque l'angle dépasse les 90 ° à l'ouverture)
- Plan de travail avec panneau de protection sanitaire de 100mm
- Étagères intérieures avec grilles en acier plastifié, réglables en hauteur.
- Pieds en tube d'acier inoxydables, réglables en hauteur 125-200mm
- Condensateur ventilé et extractible.
- Evaporateur avec système à marche forcée et recouvrement anticorrosion.
- Evaporation automatique de l'eau de dégivrage.
- Isolation en polyuréthane injecté, densité de 40 Kg / m³, faible GWP et aucun effet ODP.
- Le Contrôle digital de température ainsi que le dégivrage automatique œuvre à une meilleure gestion de la consommation énergétique.
- Température de travail à 32°C ambiant
- Éclairage intérieur que sur les modèles avec portes en verre



Modelo Model Modèle	Largo Length Longueur mm	Alto Height Hauteur mm	Fondo Depth Profondeur mm	Rango Range Gamme	Estantes Shelves Étagères	Capacidad Capacity Exposition L	Voltaje Voltage Tension	Refrig. Coolant Frigorigène	Potencia Frig. Frig Power Puissance Frig. W	Consumo Nominal Nominal Consumption Consommation Nominale W	CCE EEC 2015/ 1094 EN16825	clase climate 2015/1094 EN16825
FD-150	1495	1040	600	-2°C +8°C	4	325	230 V - 50 Hz	R-290	502	235	B	5 (40°C 40%)
FVD-150	1495	1040	600	-2°C +8°C	4	325	230 V - 50 Hz	R-290	502	247	-	5 (40°C 40%)
FD-200	2020	1040	600	-2°C +8°C	6	504	230 V - 50 Hz	R-290	502	238	B	5 (40°C 40%)
FVD-200	2020	1040	600	-2°C +8°C	6	504	230 V - 50 Hz	R-290	502	253	-	5 (40°C 40%)
FD-250	2545	1040	600	-2°C +8°C	8	684	230 V - 50 Hz	R-290	845	379	C	5 (40°C 40%)
FVD-250	2545	1040	600	-2°C +8°C	8	684	230 V - 50 Hz	R-290	845	397	-	5 (40°C 40%)

OPCIONES · OPTIONS · OPTIONS

Parrilla adicional	Extra shelf	Grille additionnelle	23 € x ud
Set 4 ruedas	4 Castors set	Jeu 4 roulettes	93 € x set
Set 6 ruedas	6 Castors set	Jeu 6 roulettes	139 € x set
Cambio cajon neutro por cajón tolva	Change neutral drawer for hopper drawer	Remplacer le tiroir neutre par un tiroir à trémie	137 € x set
230V 60hz / 115v 60hz	230V 60hz / 115v 60hz	230V 60hz / 115v 60hz	consultar - consult - consulter

*Modelos en HFC, consultar precio / HFC Models, consult prices / Modèles HFC, consulter prix

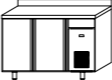
Características técnicas y constructivas sujetas a variación sin previo aviso. / We reserve the right to change specifications without prior notice. / Sujet technique et la conception de modifications sans préavis.

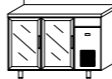
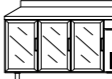
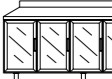
 FD-150 2.158 €	 FD-200 2.588 €	 FD-250 3.058 €
 FVD-150 2.370 €	 FVD-200 2.881 €	 FVD-250 3.526 €

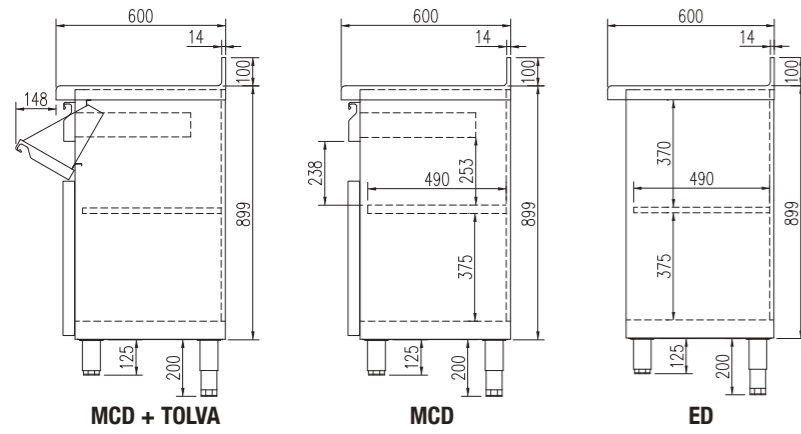

ED-200



MCD-150

CARACTERÍSTICAS TÉCNICAS	TECHNICAL DATA	CARACTÉRISTIQUES TECHNIQUES
<p>MCD</p> <ul style="list-style-type: none"> Exterior en acero inox AISI-304 18/10, excepto el respaldo. Respaldo en acero plastificado. Apoyos inox, regulables en altura. Cajones auxiliares sobre guías con rodamientos. Tolva para café con golpeador. Pueden fabricarse, bajo pedido, en diferentes medidas <p>ED</p> <ul style="list-style-type: none"> Respaldo en acero plastificado Encimera de acero inox AISI-304 18/10 con frente curvo y peto trasero sanitario de 100 mm (Opcional sin peto) Pies en tubo de acero inox ajustables en altura 125-200 mm 	<p>MCD</p> <ul style="list-style-type: none"> AISI-304 18/10 stainless steel exterior, except for backing. Plasticised steel backing. Height-adjustable stainless steel supports. Auxiliary drawers on guides with wheels. Coffee sediment special drawer with hitting surface. Can be produced on request, in different measures <p>ED</p> <ul style="list-style-type: none"> Rear panel in plasticized steel AISI-30418/10 stainless steel worktop, with rounded front and 100 mm sanitary up stand (optional without up stand) AISI -304 18/10 adjustable legs, 125 to 200mm 	<p>MCD</p> <ul style="list-style-type: none"> Extérieur en acier inoxydable AISI 304 18/10. sauf dossier. Dossier en acier plastifié Supports en inox, réglables en hauteur. Tiroirs auxiliaires sur rails à roulements. Trémie à café avec percuteur. Ce produit peut se fabriquer en différentes dimensions, sur commande. <p>ED</p> <ul style="list-style-type: none"> Dossier en acier plastifié Plan de travail en acier inoxydable AISI-304 18/10, avec partie avant inclinée et panneau de protection arrière de 100mm (possible sans panneau de protection sur option) Pieds en tube d'acier inoxydable, réglables en hauteur 125-200mm

Modelo	Largo	Alto	Fondo	Peso Neto	Cajones
Model	Length	Height	Depth	Net Weight	Drawers
Modèle	Longueur	Hauteur	Profondeur	Poid Net	Tiroirs
	mm	mm	mm	Kg	
MCD-100	1000	1040	600	66	1
MCD-150	1495	1040	600	75	2
MCD-200	2020	1040	600	84	2
ED-100	1000	1040	600	49	NO
ED-150	1495	1040	600	60	NO
ED-200	2020	1040	600	71	NO

Características técnicas y constructivas sujetas a variación sin previo aviso. / We reserve the right to change specifications without prior notice. / Sujet technique et la conception de modifications sans préavis.

 ED-100 639 €	 ED-150 768 €	 ED-200 930 €
 MCD-100 853 €	 MCD-150 1.009 €	 MCD-200 1.230 €



ASD-55

CARACTERÍSTICAS TÉCNICAS

- Exterior e interior acero inox AISI-304 18/8, excepto el respaldo
- Puertas de apertura reversible, con sistema de cierre automático y burlete magnético (permanece abierta al superar los 90° de apertura)
- ASVD doble cristal
- Estantes interiores de alambre en acero plastificado, regulables en altura
- Pies en tubo de acero inox ajustables en altura 125-200 mm
- Cuadro de mandos y rejilla ventilación motor, desmontables
- Unidad condensadora ventilada
- Evaporador sistema tiro forzado, con recubrimiento anticorrosión
- Paro ventiladores tiro forzado al abrir la puerta
- Evaporación automática del agua de descarche
- 40 Kg/m³ density polyurethane insulation, low GWP and zero ODP effect
- Energy efficient digital controller of temperature and defrosts
- Temperatura de trabajo a 32°C ambiente
- Luz interior solo en modelos con puertas de cristal

TECHNICAL DATA

- AISI-304 18/8 stainless steel exterior and interior, except the rear side
- Doors with self closing system, blocked opening, magnetic gasket and possibility of changing the opening sense
- ASVD double glazed door
- Shelves made of plasticized steel wire, height adjustable
- AISI -304 18/10 adjustable legs, 125 to 200 mm
- Control panel and engine ventilation grill, removable
- Fan assisted condenser unit
- Fan assisted evaporator, with anticorrosion coating
- Evaporator fan stops when door is opened
- Automatic evaporation of defrost water
- 40 Kg/m³ density polyurethane insulation, low GWP and zero ODP effect
- Energy efficient digital controller of temperature and defrosts
- Operating temperature 32°C ambient
- Interior light only on models with glass doors

CARACTÉRISTIQUES TECHNIQUES

- Extérieur et intérieur en acier inox AISI-304 18/8, à l'exception de la partie arrière
- Ouverture des portes réversibles avec système de fermeture automatique avec joint magnétique (la porte se maintient ouverte lorsque l'angle dépasse les 90° à l'ouverture)
- ASVD Double vitrage
- Étagères intérieures avec Fils d'acier plastifiés, réglables en hauteur.
- Pieds en tube d'acier inoxydable réglables en hauteur 125 - 200 mm
- Tableau de bord et grille de ventilation du moteur amovibles
- Unité de condensation ventilée
- Evaporateurs avec système de marche forcée et recouvrement anticorrosion.
- Arrêt automatique des ventilateurs et du système de marche forcée à l'ouverture de la porte.
- Evaporation automatique des eaux de dégivrage.
- Isolation à base de polyuréthane injecté, densité 40 kg / m³, faible GWP et aucun effet ODP.
- Le Contrôle digital de température ainsi que le dégivrage automatique œuvre à une meilleure gestion de la consommation énergétique.
- Température ambiante de travail à 32°C
- Éclairage intérieur que sur les modèles avec portes en verre



ASD-55

ASVD-55

Modelo Model Modèle	Largo Length Longueur mm	Alto Height Hauteur mm	Fondo Depth Profondeur mm	Rango Range Gamme	Estantes Shelves Étagères	Capacidad Capacity Exposition L	Voltaje Voltage Tension	Refrig. Coolant Frigorigène	Potencia Frig. Frig Power Puissance Frig. W	Consumo Nominal Nominal Consumption Consommation Nominale W	Rango Range Gamme	clase climate 2015/1094 EN16825
ASD-55	530	2040	770	-2°C +8°C	3	409	230 V - 50 Hz	R-290	303	201	E	5 (40°C 40%)
ASVD-55	530	2040	770	-2°C +8°C	3	409	230 V - 50 Hz	R-290	303	213	-	4 (30°C 55%)
ASND-55	530	2040	770	-20°C -15°C	3	409	230 V - 50 Hz	R-290	495	474	E	4 (30°C 55%)

OPCIONES · OPTIONS · OPTIONS

Parrilla adicional	Extra shelf	Grille additionnelle	27 € x ud
Set 4 ruedas	4 Castors set	Jeu 4 roulettes	98 € x set
230V 60hz / 115v 60hz	230V 60hz / 115v 60hz	230V 60hz / 115v 60hz	consultar - consult - consulter

*Modelos en HFC, consultar precio / HFC Models, consult prices / Modèles HFC, consulter prix

Características técnicas y constructivas sujetas a variación sin previo aviso. / We reserve the right to change specifications without prior notice. / Sujet technique et la conception de modifications sans préavis.

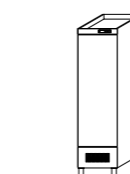

ASD-55 1.969 €
ASND-55 2.632 €

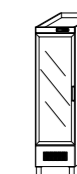

ASVD-55 2.262 €

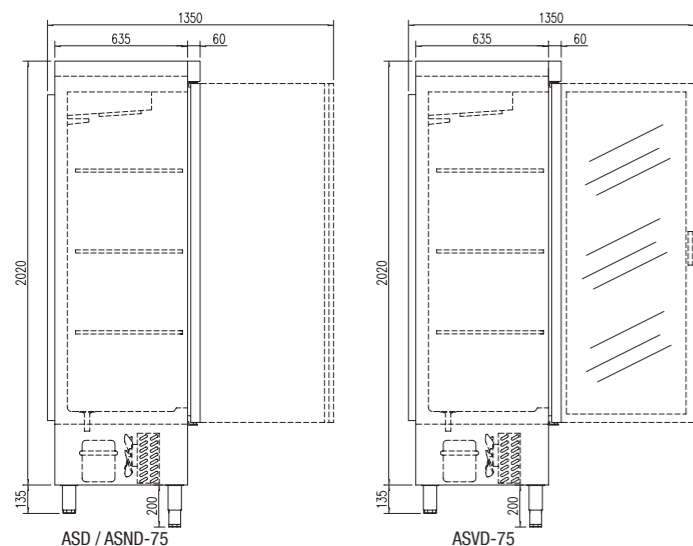

CARACTERÍSTICAS TÉCNICAS	TECHNICAL DATA	CARACTÉRISTIQUES TECHNIQUES
<ul style="list-style-type: none"> Exterior e interior en acero AISI-304 Puertas de apertura reversible, con sistema de cierre automático y burlete magnético (permanece abierta al superar los 90° de apertura) Contrapuerta inox embutida Estantes interiores de alambre en acero plastificado, regulables en altura Pies en tubo de acero inox ajustables en altura 125-200 mm Cuadro de mandos y rejilla ventilación motor, desmontables Unidad condensadora ventilada Evaporador sistema tiro forzado, con recubrimiento anticorrosión Paro ventiladores tiro forzado al abrir la puerta Evaporación automática del agua de descarche Aislamiento de poliuretano inyectado, densidad 40 Kg/m³, bajo GWP y cero efecto ODP Control digital de temperatura y descarches, eficiente en la gestión del consumo de energía Temperatura de trabajo a 32°C ambiente Luz interior solo en modelos con puertas de cristal 	<ul style="list-style-type: none"> Exterior and interior steel AISI-304 Doors with self closing system, blocked opening, magnetic gasket and possibility of changing the opening sense Rear-door by stamped steel Shelves made of plasticized steel wire, height adjustable AISI -304 18/10 adjustable legs, 125 to 200 mm Control panel and engine ventilation grill, removable Fan assisted condenser unit Fan assisted evaporator, with anticorrosion coating Evaporator fan stops when door is opened Automatic evaporation of defrost water 40 Kg/m³ density polyurethane insulation, low GWP and zero ODP effect Energy efficient digital controller of temperature and defrosts Operating temperature 32°C ambient Interior light only on models with glass doors 	<ul style="list-style-type: none"> Extérieur et intérieur en acier AISI-304 Ouverture des portes réversibles avec système de fermeture automatique avec joint magnétique (la porte se maintient ouverte lorsque l'angle dépasse les 90 ° à l'ouverture) Contreporte en Inox encastrée Étagères intérieures avec Fils d'acier plastifiés, réglables en hauteur. Pieds en tube d'acier inoxydable réglables en hauteur 125 - 200 mm Tableau de bord et grille de ventilation du moteur amovibles Unité de condensation ventilée Évaporateurs avec système de marche forcée et recouvrement anticorrosion. Arrêt automatique des ventilateurs et du système de marche forcée à l'ouverture de la porte. Évaporation automatique des eaux de dégivrage. Isolation à base de polyuréthane injecté, densité 40 kg / m³, faible GWP et aucun effet ODP. Le Contrôle digital de température ainsi que le dégivrage automatique œuvre à une meilleure gestion de la consommation énergétique. Température ambiante de travail à 32°C Eclairage intérieur que sur les modèles avec portes en verre



ASD-75



ASVD-75



Modelo	Largo	Alto	Fondo	Rango	Estantes	Capacidad	Voltaje	Refrig.	Potencia Frig.	Consumo Nominal	Rango	clase climate
Model	Length	Height	Depth	Range	Shelves	Capacity	Voltage	Coolant	Frig Power	Nominal Consumption	Range	2015/1094 EN16825
Modèle	Longueur	Hauteur	Profondeur	Gamme	Étagères	Exposition	Tension	Frigorigène	Puissance Frig.	Consommation Nominale	Gamme	EN16825
	mm	mm	mm		GN 2/1	L			W	W		
ASD-75	660	2160	735	-2°C +8°C	3	505	230 V - 50 Hz	R-290	502	243	D	5 (40°C 40%)
ASND-75	660	2160	735	-20°C -15°C	3	505	230 V - 50 Hz	R-290	606	553	E	4 (30°C 55%)
ASVD-75	660	2160	735	-2°C +8°C	3	505	230 V - 50 Hz	R-290	502	260	-	4 (30°C 55%)

OPCIONES · OPTIONS · OPTIONS			
Parrilla adicional	Extra shelf	Grille additionnelle	26 € x ud
Set 4 ruedas	4 Castors set	Jeu 4 roulettes	93 € x set
230V 60hz / 115v 60hz	230V 60hz / 115v 60hz	230V 60hz / 115v 60hz	consultar - consult - consulter

*Modelos en HFC, consultar precio / HFC Models, consult prices / Modèles HFC, consulter prix

Características técnicas y constructivas sujetas a variación sin previo aviso. / We reserve the right to change specifications without prior notice. / Sujet technique et la conception de modifications sans préavis.

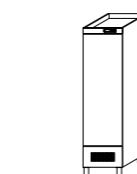

ASD-75 **2.183 €**
ASND-75 **2.673 €**

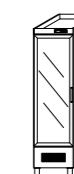

ASVD-75 **2.433 €**

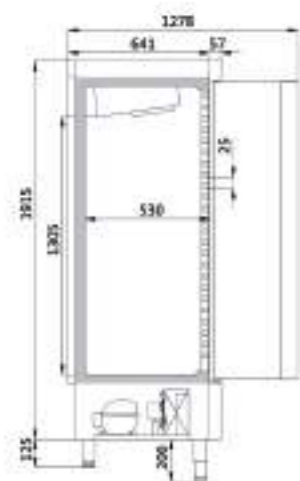

ASD / ASND-125



ASD-125



ASVD-125

CARACTERÍSTICAS TÉCNICAS	TECHNICAL DATA	CARACTÉRISTIQUES TECHNIQUES
<ul style="list-style-type: none"> Exterior e interior en acero AISI-304 Puertas de apertura reversible, con sistema de cierre automático y burlete magnético (permanece abierta al superar los 90° de apertura) ASVD doble cristal Estantes interiores de alambre en acero plastificado, regulables en altura Pies en tubo de acero inox ajustables en altura 125-200 mm Cuadro de mandos y rejilla ventilación motor, desmontables Unidad condensadora ventilada Evaporador sistema tiro forzado, con recubrimiento anticorrosión Paro ventiladores tiro forzado al abrir la puerta Evaporación automática del agua de descarche Aislamiento de poliuretano inyectado, densidad 40 Kg/m³, bajo GWP y cero efecto ODP Control digital de temperatura y descarches, eficiente en la gestión del consumo de energía Temperatura de trabajo a 32°C ambiente Luz interior solo en modelos con puertas de cristal 	<ul style="list-style-type: none"> Exterior and interior steel AISI-304 Doors with self closing system, blocked opening, magnetic gasket and possibility of changing the opening sense ASVD double glazed door Shelves made of plasticized steel wire, height adjustable AISI -304 18/10 adjustable legs, 125 to 200 mm Control panel and engine ventilation grill, removable Fan assisted condenser unit Fan assisted evaporator, with anticorrosion coating Evaporator fan stops when door is opened Automatic evaporation of defrost water 40 Kg/m³ density polyurethane insulation, low GWP and zero ODP effect Energy efficient digital controller of temperature and defrosts Operating temperature 32°C ambient Interior light only on models with glass doors 	<ul style="list-style-type: none"> Extérieur et intérieur en acier AISI-304 Ouverture des portes réversibles avec système de fermeture automatique avec joint magnétique (la porte se maintient ouverte lorsque l'angle dépasse les 90° à l'ouverture) ASVD Double vitrage Étagères intérieures avec Fils d'acier plastifiés, réglables en hauteur. Pieds en tube d'acier inoxydable réglables en hauteur 125 - 200 mm Tableau de bord et grille de ventilation du moteur amovibles Unité de condensation ventilée Évaporateurs avec système de marche forcée et recouvrement anticorrosion. Arrêt automatique des ventilateurs et du système de marche forcée à l'ouverture de la porte. Évaporation automatique des eaux de dégivrage. Isolation à base de polyuréthane injecté, densité 40 kg / m³, faible GWP et aucun effet ODP. Le Contrôle digital de température ainsi que le dégivrage automatique œuvre à une meilleure gestion de la consommation énergétique. Température ambiante de travail à 32°C Éclairage intérieur que sur les modèles avec portes en verre

Modelo / Model / Modèle	Largo / Length / Longueur mm	Alto / Height / Hauteur mm	Fondo / Depth / Profondeur mm	Rango / Range / Gamme	Estantes / Shelves / Étagères	Capacidad / Capacity / Exposition L	Voltaje / Voltage / Tension	Refrig. / Coolant / Frigorigène	Potencia Frig. / Frig Power / Puissance Frig. W	Consumo Nominal / Nominal Consumption / Consommation Nominale W	CCE / EEC / 2015/1094 EN16825	clase climate / 2015/1094 EN16825
ASD-125	1250	2040	700	-2°C +8°C	6	964	230 V - 50 Hz	R-290	543	416	D	5 (40°C 40%)
ASND-125	1250	2040	700	-20°C -15°C	6	964	230 V - 50 Hz	R-290	833	810	E	4 (30°C 55%)
ASVD-125	1250	2040	700	-2°C +8°C	6	964	230 V - 50 Hz	R-290	543	434	-	4 (30°C 55%)

OPCIONES - OPTIONS - OPTIONS			
Parrilla adicional	Extra shelf	Grille additionnelle	46 € x ud
Set 6 ruedas	6 Castors set	Jeu 6 roulettes	146 € x set
230V 60hz / 115v 60hz	230V 60hz / 115v 60hz	230V 60hz / 115v 60hz	consultar - consult - consulter

*Modelos en HFC, consultar precio / HFC Models, consult prices / Modèles HFC, consulter prix

Características técnicas y constructivas sujetas a variación sin previo aviso. / We reserve the right to change specifications without prior notice. / Sujet technique et la conception de modifications sans préavis.

ASD-125 2.711 €	ASD-125-3 2.759 €	ASD-125-4 2.807 €	ASVD-125 3.168 €
ASND-125 3.616 €			

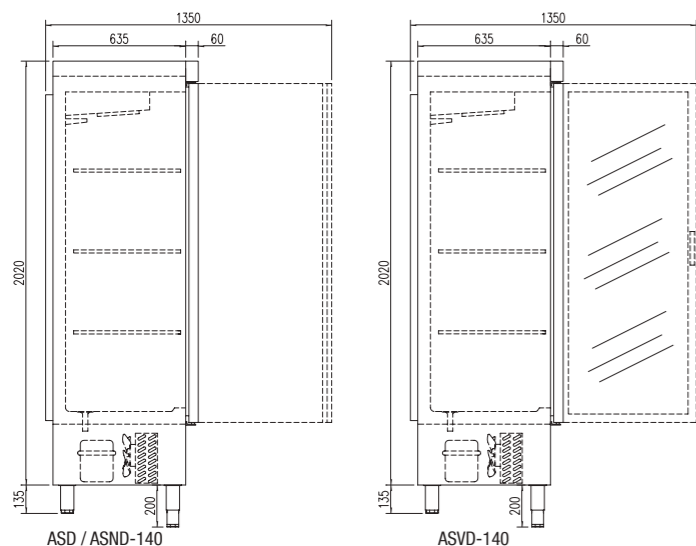

ASD-140



LED

CARACTERÍSTICAS TÉCNICAS

- Exterior e interior en acero AISI-304
- Puertas de apertura reversible, con sistema de cierre automático y burlete magnético (permanece abierta al superar los 90° de apertura)
- ASVD doble cristal
- Estantes interiores de alambre en acero plastificado, regulables en altura
- Pies en tubo de acero inox ajustables en altura 125-200 mm
- Cuadro de mandos y rejilla ventilación motor, desmontables
- Unidad condensadora ventilada
- Evaporador sistema tiro forzado, con recubrimiento anticorrosión
- Paro ventiladores tiro forzado al abrir la puerta
- Evaporación automática del agua de descarche
- Aislamiento de poliuretano inyectado, densidad 40 Kg/m³, bajo GWP y cero efecto ODP
- Control digital de temperatura y descarches, eficiente en la gestión del consumo de energía
- Temperatura de trabajo a 32°C ambiente
- Luz interior solo en modelos con puertas de cristal

TECHNICAL DATA

- Exterior and interior steel AISI-304
- Doors with self closing system, blocked opening, magnetic gasket and possibility of changing the opening sense
- ASVD double glazed door
- Shelves made of plasticized steel wire, height adjustable
- AISI -304 18/10 adjustable legs, 125 to 200 mm
- Control panel and engine ventilation grill, removable
- Fan assisted condenser unit
- Fan assisted evaporator, with anticorrosion coating
- Evaporator fan stops when door is opened
- Automatic evaporation of defrost water
- 40 Kg/m³ density polyurethane insulation, low GWP and zero ODP effect
- Energy efficient digital controller of temperature and defrosts
- Operating temperature 32°C ambient
- Interior light only on models with glass doors

CARACTÉRISTIQUES TECHNIQUES

- Extérieur et intérieur en acier AISI-304
- Ouverture des portes réversibles avec système de fermeture automatique avec joint magnétique (la porte se maintient ouverte lorsque l'angle dépasse les 90° à l'ouverture)
- ASVD Double vitrage
- Étagères intérieures avec Fils d'acier plastifiés, réglables en hauteur.
- Pieds en tube d'acier inoxydable réglables en hauteur 125 - 200 mm
- Tableau de bord et grille de ventilation du moteur amovibles
- Unité de condensation ventilée
- Évaporateurs avec système de marche forcée et recouvrement anticorrosion.
- Arrêt automatique des ventilateurs et du système de marche forcée à l'ouverture de la porte.
- Évaporation automatique des eaux de dégivrage.
- Isolation à base de polyuréthane injecté, densité 40 kg / m³, faible GWP et aucun effet ODP.
- Le Contrôle digital de température ainsi que le dégivrage automatique œuvre à une meilleure gestion de la consommation énergétique.
- Température ambiante de travail à 32°C
- Eclairage intérieur que sur les modèles avec portes en verre

Model / Modèle	Largo / Longueur mm	Alto / Hauteur mm	Fondo / Profondeur mm	Rango / Gamme	Estantes / Shelves / Étagères GN 2/1	Capacidad / Capacity / Exposition L	Voltaje / Voltage / Tension	Refrig. / Coolant / Frigorigène	Potencia Frig. / Frig Power / Puissance Frig. W	Consumo Nominal / Nominal Consumption / Consommation Nominale W	Rango / Range / Gamme	clase climate / classe climatique 2015/1094 EN16825
ASD-140	1350	2160	735	-2°C +8°C	6 + 3	1201	230 V - 50 Hz	R-290	845	373	D	5 (40°C 40%)
ASND-140	1350	2160	735	-20°C -15°C	6 + 3	1201	230 V - 50 Hz	R-290	907	952	E	4 (30°C 55%)
ASVD-140	1350	2160	735	-2°C +8°C	6 + 3	1201	230 V - 50 Hz	R-290	845	396	-	4 (30°C 55%)

OPCIONES - OPTIONS - OPTIONS

Parrilla adicional	Extra shelf	Grille additionnelle	33 € x ud
Parrilla intermedia adicional	Extra middle shelf	Kit supplémentaire de guides	22 € x ud
Set 4 ruedas	4 Castors set	Jeu 4 roulettes	93 € x set
Set 6 ruedas	6 Castors set	Jeu 6 roulettes	139 € x set
230V 60hz / 115v 60hz	230V 60hz / 115v 60hz	230V 60hz / 115v 60hz	consultar - consult - consulter

*Modelos en HFC, consultar precio / HFC Models, consult prices / Modèles HFC, consulter prix

Características técnicas y constructivas sujetas a variación sin previo aviso. / We reserve the right to change specifications without prior notice. / Sujet technique et la conception de modifications sans préavis.

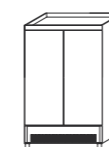

ASD-140 **2.952 €**
ASND-140 **3.729 €**

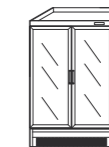

ASVD-140 **3.450 €**

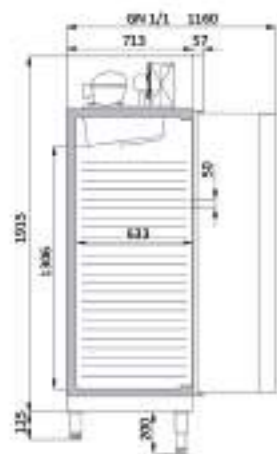

AGD-50

CARACTERÍSTICAS TÉCNICAS

- Exterior e interior en acero inox AISI-304 excepto el respaldo
- Puertas de apertura reversible, con sistema de cierre automático y burlete magnético (permanece abierta al superar los 90° de apertura)
- AGVD doble cristal
- Estantes interiores de alambre en acero plastificado, regulables en altura
- Pies en tubo de acero inox ajustables en altura 125-200 mm
- Cuadro de mandos y rejilla ventilación motor, desmontables
- Unidad condensadora ventilada
- Evaporador sistema tiro forzado, con recubrimiento anticorrosión
- Paro ventiladores tiro forzado al abrir la puerta
- Evaporación automática del agua de descarche
- 40 Kg/m³ density polyurethane insulation, low GWP and zero ODP effect
- Energy efficient digital controller of temperature and defrosts
- Temperatura de trabajo a 32°C ambiente
- Luz interior solo en modelos con puertas de cristal

TECHNICAL DATA

- AISI-304 stainless steel exterior and interior, except the rear side
- Interior stainless steel AISI-430, except the sausage background and storm-manufactured in AISI-304
- Doors with self closing system, blocked opening, magnetic gasket and possibility of changing the opening sense
- AGVD double glazed door
- Shelves made of plasticized steel wire, height adjustable
- AISI -304 18/10 adjustable legs, 125 to 200 mm
- Control panel and engine ventilation grill, removable
- Fan assisted condenser unit
- Fan assisted evaporator, with anticorrosion coating
- Evaporator fan stops when door is opened
- Automatic evaporation of defrost water
- 40 Kg/m³ density polyurethane insulation, low GWP and zero ODP effect
- Energy efficient digital controller of temperature and defrosts
- Operating temperature 32°C ambient
- Interior light only on models with glass doors

CARACTÉRISTIQUES TECHNIQUES

- Extérieur et intérieur en acier inox AISI-304, à l'exception de la partie arrière
- Intérieur en acier inoxydable AISI-430, à l'exception de fond de la saucisse et de la tempête-fabriqué en acier inox AISI-304
- Ouverture des portes réversibles avec système de fermeture automatique avec joint magnétique (la porte se maintient ouverte lorsque l'angle dépasse les 90° à l'ouverture)
- AGVD Double vitrage
- Étagères intérieures avec Fils d'acier plastifiés, réglables en hauteur.
- Pieds en tube d'acier inoxydable réglables en hauteur 125 - 200 mm
- Tableau de bord et grille de ventilation du moteur amovibles
- Unité de condensation ventilée
- Evaporateurs avec système de marche forcée et recouvrement anticorrosion.
- Arrêt automatique des ventilateurs et du système de marche forcée à l'ouverture de la porte.
- Evaporation automatique des eaux de dégivrage.
- Isolation à base de polyuréthane injecté, densité 40 kg / m³, faible GWP et aucun effet ODP.
- Le Contrôle digital de température ainsi que le dégivrage automatique œuvre à une meilleure gestion de la consommation énergétique.
- Température ambiante de travail à 32°C
- Eclairage intérieur que sur les modèles avec portes en verre



AGD-50



AGVD-50 2.171 €

Modelo Modèle	Largo Longueur mm	Alto Hauteur mm	Fondo Profondeur mm	Rango Gamme	Estantes Shelves Étagères	Capacidad Capacity Exposition L	Voltaje Voltage Tension	Refrig. Coolant Frigorigène	Potencia Frig. Frig Power Puissance Frig. W	Consumo Nominal Nominal Consumption Consommation Nominale W	CCE EEC 2015/1094 EN16825	clase climate 2015/1094 EN16825
AGD-50	430	2040	770	-2°C +8°C	3	303	230 V - 50 Hz	R-290	271	201	E	5 (40°C 40%)
AGND-50	430	2040	770	-20°C -15°C	3	303	230 V - 50 Hz	R-290	385	432	E	4 (30°C 55%)
AGVD-50	430	2040	770	-2°C +8°C	3	303	230 V - 50 Hz	R-290	271	213	-	4 (30°C 55%)

OPCIONES - OPTIONS - OPTIONS

Parrilla adicional GN 1/1	GN 1/1 Extra shelf	Grille additionnelle GN 1/1	28 € x ud
Set 4 ruedas	4 Castors set	Jeu 4 roulettes	98 € x set
230V 60hz / 115v 60hz	230V 60hz / 115v 60hz	230V 60hz / 115v 60hz	consultar - consult - consulter

*Modelos en HFC, consultar precio / HFC Models, consult prices / Modèles HFC, consulter prix

Características técnicas y constructivas sujetas a variación sin previo aviso. / We reserve the right to change specifications without prior notice. / Sujet technique et la conception de modifications sans préavis.

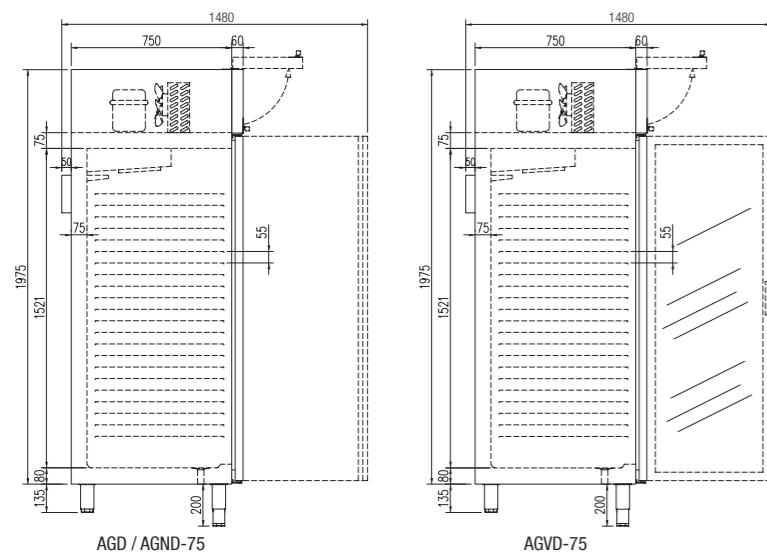

CARACTERÍSTICAS TÉCNICAS

- Modelos **SPEED** Exterior e interior en acero AISI-304
- Modelos **SPEED-F** Exterior e interior en acero AISI-430, excepto fondo interior y contrapuestas en AISI-304
- Puertas de apertura reversible, con sistema de cierre automático y burlete magnético (permanece abierta al superar los 90° de apertura)
- Cerradura con llave, de serie
- Contrapuerta inox embutida
- Estantes interiores GN 2/1, de alambre en acero plastificado, regulables en altura
- Pies en tubo de acero inox ajustables en altura 125-200 mm
- Cuadro de mandos y rejilla ventilación motor, desmontables
- Sistema frigorífico COMPACTO: unidad condensadora + evaporador
- Unidad condensadora ventilada
- Evaporador sistema tiro forzado, con recubrimiento anticorrosión
- Paro ventiladores tiro forzado al abrir la puerta
- Aislamiento de poliuretano inyectado, densidad 40 Kg/m³, bajo GWP y cero efecto ODP
- Control digital de temperatura y descargas, eficiente en la gestión del consumo de energía
- Control digital de temperatura y descargas
- Temperatura de trabajo a 32°C ambiente
- Luz interior solo en modelos con puertas de cristal

TECHNICAL DATA

- Models **SPEED** Exterior and interior steel AISI-304
- Models **SPEED-F** Exterior and interior in AISI-430 steel, except storm doors interior and bottom AISI-304
- Doors with self closing system, blocked opening, magnetic gasket and possibility of changing the opening sense
- Key lock as standard
- Rear-door by stamped steel
- GN 2/1 shelves made of plasticized steel wire, height adjustable
- AISI -304 18/10 adjustable legs, 125 to 200 mm
- Control panel and engine ventilation grill, removable
- COMPACT refrigeration system: condenser unit + evaporator
- Fan assisted condenser unit
- Fan assisted evaporator, with anticorrosion coating
- Evaporator fan stops when door is opened
- Automatic evaporation of defrost water
- 40 Kg/m³ density polyurethane insulation, low GWP and zero ODP effect
- Energy efficient digital controller of temperature and defrosts
- Operating temperature 32°C ambient
- Interior light only on models with glass doors

CARACTÉRISTIQUES TECHNIQUES

- Modèles **SPEED** Extérieur et intérieur en acier AISI-304
- Modèles **SPEED-F** Extérieur et intérieur en acier AISI-430, sauf contre-portes intérieure et inférieure AISI-304
- Ouverture des portes réversibles avec système de fermeture automatique avec joint magnétique (la porte se maintient ouverte lorsque l'angle dépasse les 90° à l'ouverture)
- Fermeture à clé de série
- Contreporte en inox encastrée
- Étagères intérieures GN 2/1 avec Fils d'acier plastifiés, réglables en hauteur.
- Pieds en tube d'acier inoxydable réglables en hauteur 125 - 200 mm
- Tableau de bord et grille de ventilation du moteur amovibles
- Système Frigorifique COMPACT : unité condensatrice + évaporateur
- Unité de condensation ventilée
- Évaporateurs avec système de marche forcée et recouvrement anticorrosion.
- Arrêt automatique des ventilateurs et du système de marche forcée à l'ouverture de la porte
- Évaporation automatique des eaux de dégivrage
- Isolation à base de polyuréthane injecté, densité 40 kg / m³, faible GWP et aucun effet ODP.
- Le Contrôle digital de température ainsi que le dégivrage automatique œuvre à une meilleure gestion de la consommation énergétique.
- Contrôle digital de température et de dégivrage
- Température ambiante de travail à 32°C
- Eclairage intérieur que sur les modèles avec portes en verre



LED

Modelo / Modél / Modèle	Largo / Length / Longueur (mm)	Alto / Height / Hauteur (mm)	Fondo / Depth / Profondeur (mm)	Rango / Range / Gamme	Estantes / Shelves / Étagères GN 2/1	Nivel estantes / Sets of sidles / Kit de guides	Capacidad / Capacity / Exposition (L)	Voltaje / Voltage / Tension	Refrig. / Coolant / Frigorigène	Potencia Frig. / Frig Power / Puissance Frig. (W)	Consumo Nominal / Nominal Consumption / Consommation Nominale (W)	Rango / Range / Gamme	clase climate / 2015/1094 EN16825
AGD-75-PF	660	2130	850	-2°C +8°C	3	22	645	230 V - 50 Hz	R-290	502	243	C	5 (40°C 40%)
AGVD-75-PF	660	2130	850	-20°C -15°C	3	22	645	230 V - 50 Hz	R-290	502	260	-	4 (30°C 55%)
AGND-75-PF	660	2130	850	-2°C +8°C	3	22	645	230 V - 50 Hz	R-290	606	553	D	4 (30°C 55%)

OPCIONES - OPTIONS - OPTIONS

Parrilla adicional GN 2/1	GN 2/1 extra shelf	Grille additionnelle GN 2/1	52 € x ud
Set 4 ruedas	4 Castors set	Jeu 4 roulettes	93 € x set
230V 60hz / 115v 60hz	230V 60hz / 115v 60hz	230V 60hz / 115v 60hz	consultar - consult - consulter

*Modelos en HFC, consultar precio / HFC Models, consult prices / Modèles HFC, consulter prix

Características técnicas y constructivas sujetas a variación sin previo aviso. / We reserve the right to change specifications without prior notice. / Sujet technique et la conception de modifications sans préavis.



AGD-75-PF 2.271 €
AGND-75-PF 2.881 €



AGVD-75-PF 2.420 €

AGD-75-PF-F 2.067 €
AGND-75-PF-F 2.622 €

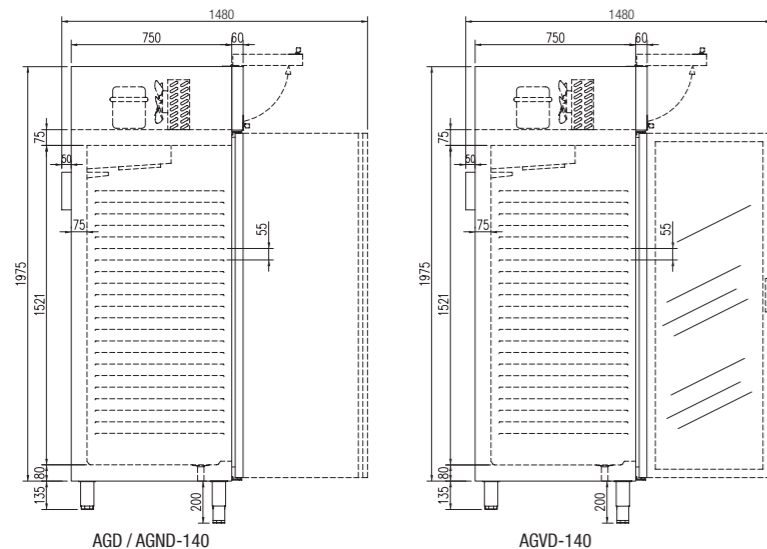

AGVD-140

CARACTERÍSTICAS TÉCNICAS	TECHNICAL DATA	CARACTÉRISTIQUES TECHNIQUES
<ul style="list-style-type: none"> Modelos SPEED Exterior e interior en acero AISI-304 Modelos SPEED-F Exterior e interior en acero AISI-430, Puertas de apertura reversible, con sistema de cierre automático y burlete magnético (permanece abierta al superar los 90° de apertura) AGVD doble cristal Estantes interiores de alambre en acero plastificado, regulables en altura Pies en tubo de acero inox ajustables en altura 125-200 mm Cuadro de mandos y rejilla ventilación motor, desmontables Unidad condensadora ventilada Evaporador sistema tiro forzado, con recubrimiento anticorrosión Paro ventiladores tiro forzado al abrir la puerta Evaporación automática del agua de descarga 40 Kg/m³ density polyurethane insulation, low GWP and zero ODP effect Energy efficient digital controller of temperature and defrosts Temperatura de trabajo a 32°C ambiente Luz interior solo en modelos con puertas de cristal 	<ul style="list-style-type: none"> Models SPEED Exterior and interior steel AISI-304 Models SPEED-F Exterior and interior in AISI-430 steel, except storm doors interior and bottom AISI-304 Doors with self closing system, blocked opening, magnetic gasket and possibility of changing the opening sense AGVD double glazed door Shelves made of plasticized steel wire, height adjustable AISI -304 18/10 adjustable legs, 125 to 200 mm Control panel and engine ventilation grill, removable Fan assisted condenser unit Fan assisted evaporator, with anticorrosion coating Evaporator fan stops when door is opened Automatic evaporation of defrost water 40 Kg/m³ density polyurethane insulation, low GWP and zero ODP effect Energy efficient digital controller of temperature and defrosts Operating temperature 32°C ambient Interior light only on models with glass doors 	<ul style="list-style-type: none"> Modèles SPEED Extérieur et intérieur en acier AISI-304 Modèles SPEED-F Extérieur et intérieur en acier AISI-430, sauf contre-portes intérieure et inférieure AISI-304 Ouverture des portes réversibles avec système de fermeture automatique avec joint magnétique (la porte se maintient ouverte lorsque l'angle dépasse les 90° à l'ouverture) AGVD Double vitrage Étagères intérieures avec Fils d'acier plastifiés, réglables en hauteur. Pieds en tube d'acier inoxydable réglables en hauteur 125 - 200 mm Tableau de bord et grille de ventilation du moteur amovibles Unité de condensation ventilée Évaporateurs avec système de marche forcée et recouvrement anticorrosion. Arrêt automatique des ventilateurs et du système de marche forcée à l'ouverture de la porte. Évaporation automatique des eaux de dégivrage. Isolation à base de polyuréthane injecté, densité 40 kg / m³, faible GWP et aucun effet ODP. Le Contrôle digital de température ainsi que le dégivrage automatique œuvre à une meilleure gestion de la consommation énergétique. Température ambiante de travail à 32°C Eclairage intérieur que sur les modèles avec portes en verre

Modelo Model Modèle	Largo Length Longueur mm	Alto Height Hauteur mm	Fondo Depth Profondeur mm	Rango Range Gamme	Estantes Shelves Étagères GN 2/1	Nivel estantes Level shelves Niveau étagère	Capacidad Capacity Exposition L	Voltaje Voltage Tension	Refrig. Coolant Frigorigène	Potencia Frig. Frig Power Puissance Frig. W	Consumo Nominal Nominal Consumption Consommation Nominale W	Rango Range Gamme	clase climate 2015/1094 EN16825 Rango Range Gamme
AGD-140-PF	1350	2130	850	-2°C +8°C	6	22	1404	230 V - 50 Hz	R-290	845	373	D	5 (40°C 40%)
AGVD-140-PF	1350	2130	850	-2°C +8°C	6	22	1404	230 V - 50 Hz	R-290	845	396	-	4 (30°C 55%)
AGND-140-PF	1350	2130	850	-20°C -15°C	6	22	1282	230 V - 50 Hz	R-290	907	883	D	4 (30°C 55%)

OPCIONES - OPTIONS - OPTIONS			
Parrilla adicional GN 2/1	GN 2/1 extra shelf	Grille additionnelle GN 2/1	52 € x ud
Set adicional guías GN	GN slides extra set	Kit supplémentaire de guides GN	26 € x set
Set 4 ruedas	4 Castors set	Jeu 4 roulettes	93 € x set
230V 60hz / 115v 60hz	230V 60hz / 115v 60hz	230V 60hz / 115v 60hz	consultar - consult - consulter

*Modelos en HFC, consultar precio / HFC Models, consult prices / Modèles HFC, consulter prix

Características técnicas y constructivas sujetas a variación sin previo aviso. / We reserve the right to change specifications without prior notice. / Sujet technique et la conception de modifications sans préavis.

AGD-140-PF	3.205 €	AGD-140-PF-F	2.917 €
AGND-140-PF	4.002 €	AGND-140-PF-F	3.642 €
		AGVD-140-PF	3.533 €

CÁMARAS Y EQUIPOS

CAMERAS AND EQUIPMENT
CAMÉRAS ET ÉQUIPEMENT



SERIE MH Página 427
Recintos frigoríficos modulares sin columnas
Modular cold rooms without columns



SERIE RFM Página 437
Recintos modulares frigoríficos
Modular cold rooms



SERIE AFD Página 447
Armario frigorífico desmontable
Modular reach-in refrigerator
Compacts de paroi centrifuges



SERIE AFD-PC Página 455
Armario frigorífico desmontable
Modular reach-in refrigerator
Compacts de paroi centrifuges



SERIE RFM-PC Página 461
Recintos frigoríficos modulares puerta de cristal
Glass door for modular cold room



CORTINAS Página 467
Cortinas de lamas
Pvc strip curtains



ESTANTERÍAS Página 471
Shelving units
Centrifugal roof top compact units
Compacts de plafond centrifuges



EQUIPOS FRIGORÍFICOS Página 479
Refrigeration equipment
Équipement de réfrigération



Serie MH

RECINTOS FRIGORÍFICOS MODULARES SIN COLUMNAS
MODULAR COLD ROOMS WITHOUT COLUMNS
RÉFRIGÉRATEURS MODULAIRES SANS COLONNES



Índice de Contenidos / Table of Contents

PRESENTACIÓN DEL RECINTO FRIGORÍFICO / PRESENTING OUR COLD ROOMS

DIMENSIONES GENERALES / GENERAL MEASUREMENTS

CARACTERÍSTICAS TÉCNICAS / TECHNICAL SPECIFICATIONS

ESTANTERÍAS / SHELVING

MODELOS DE PLANTA, MODULARIDAD / FLOOR MODELS, MODULARITY

Recintos Frigoríficos Modulares, GAMA MH, completa la primera gama presentada meses atrás por DOCRILUC. Hemos desarrollado esta gama, reduciendo los elementos constructivos manteniendo la solidez y capacidad aislante del recinto. Esta nueva gama, se manufactura siguiendo los mismos principios empleados en el resto de la producción de cámaras frigoríficas, con maquinaria controlada por computadora y personal cualificado. El resultado es una recinto frigorífico con personalidad propia y adaptado a las exigencias del mercado actual.

MH RANGE cold rooms, completes the first range presented months ago by DOCRILUC. We have developed this range, reducing the construction elements while maintaining the solidity and insulating capacity of the room. This new range is manufactured following the same principles used in the rest of the production of cold rooms, with computer-controlled machinery and qualified personnel. The result is a Refrigerating Enclosure with its own personality and adapted to the demands of the current market.

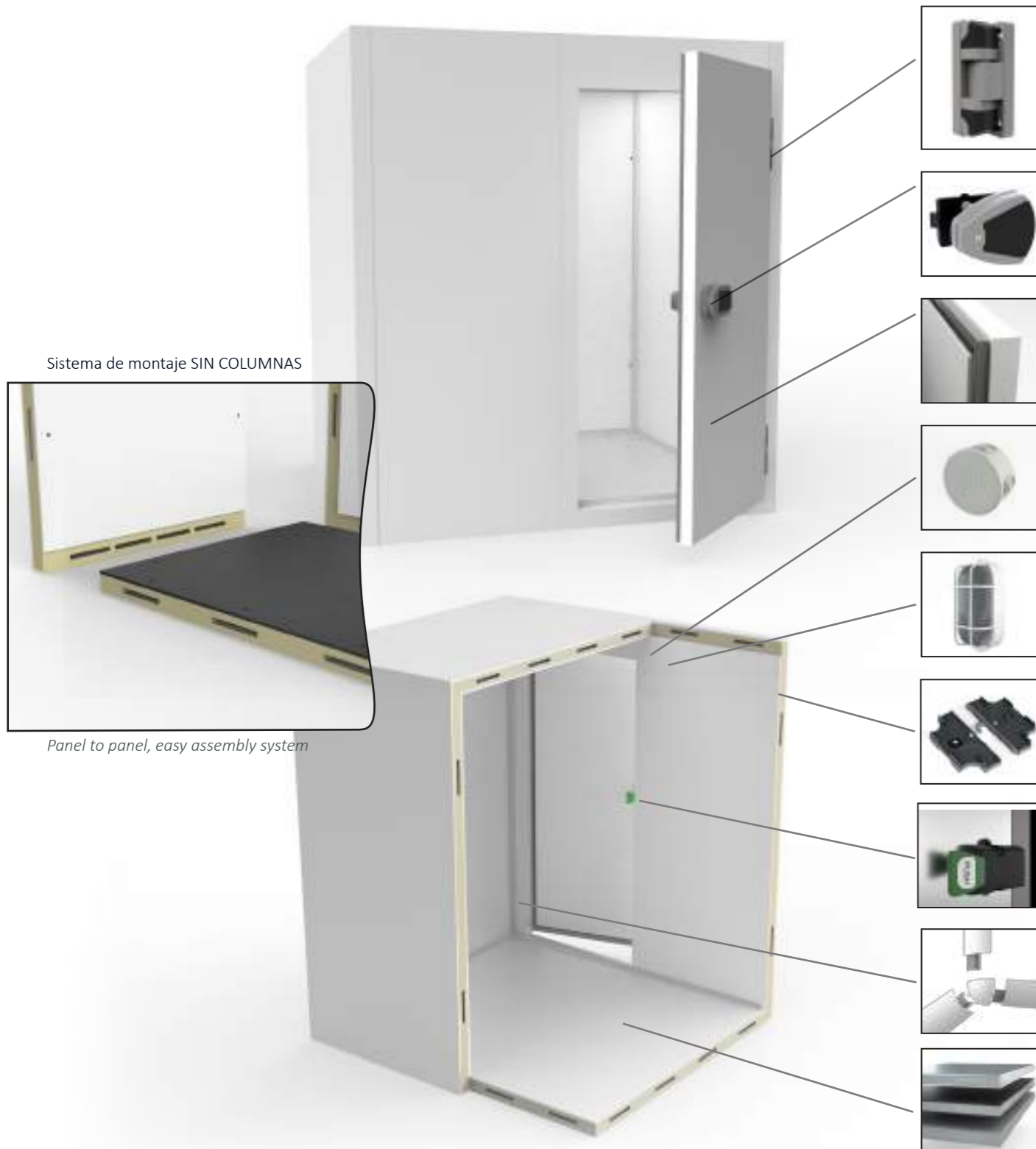

Sistema de montaje SIN COLUMNAS

Panel to panel, easy assembly system

SECCIÓN Y ALTURAS. / HEIGHTS AND SECTIONS.

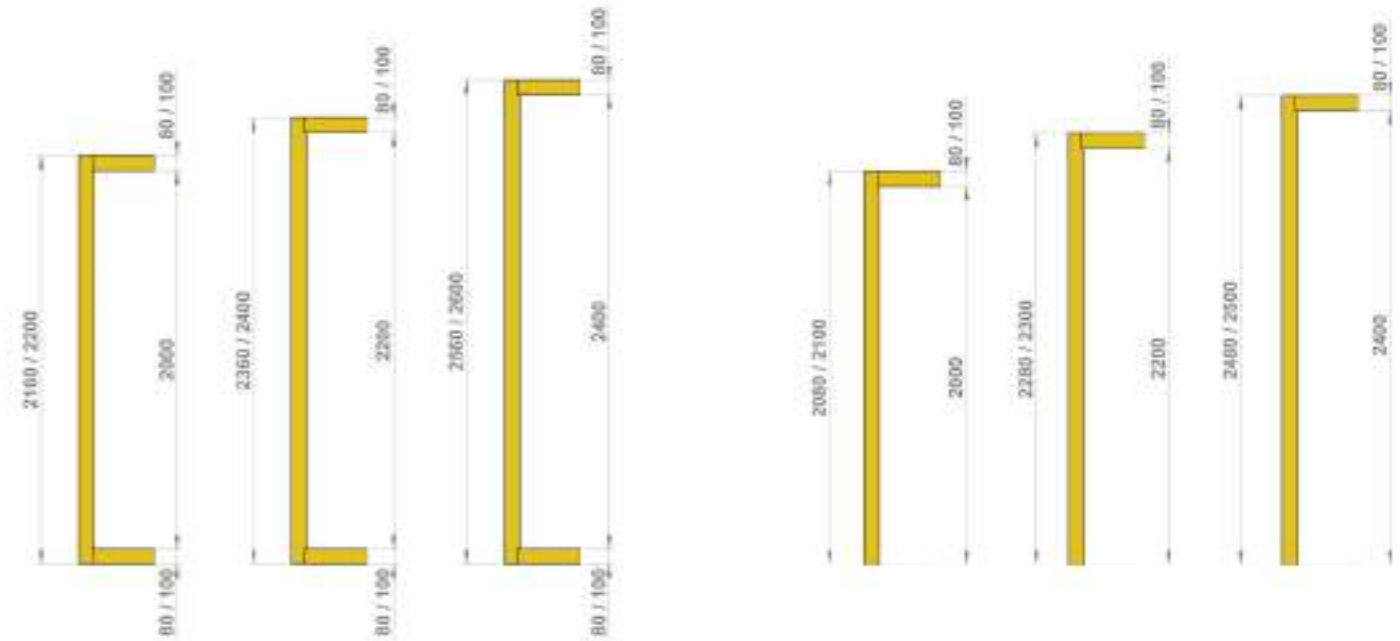

CON suelo panel
WITH floor panel

SIN suelo panel
WITHOUT floor panel

ESPACIOS NECESARIOS PARA UNA CORRECTA INSTALACIÓN.

Recomendamos una adecuada nivelación del suelo donde vaya a ser instalado el recinto frigorífico. Prever que el lugar de ubicación permite el acceso del panel de mayor dimensión.

SPACE NEEDED FOR CORRECT INSTALLATION.

We recommend an adequate leveling of the floor where the cold room will be installed. Ensure that the location allows access with the largest panel.

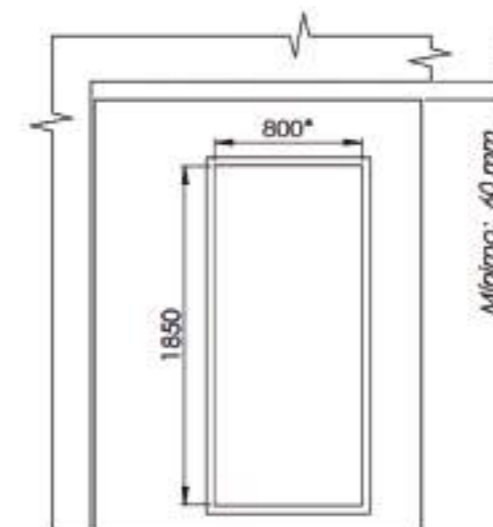

*Bajo pedido, 600, 700, 900 y 1000
*On demand 600, 700, 900 and 1000

Para poder realizar un montaje correcto es necesario dejar entre el techo del local y el techo del recinto al menos el espesor del panel + 20 mm.

For correct assembly, leave at least the thickness of a panel + 20mm between the roof of the premises and the roof of the room.

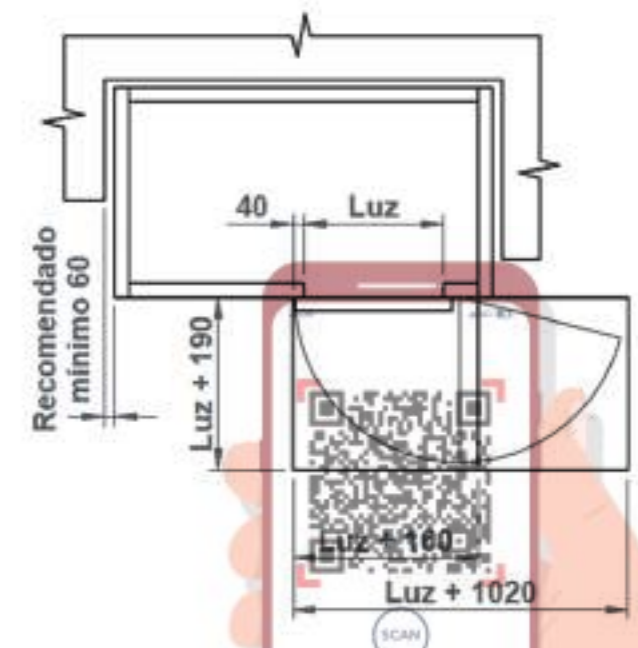

Dimensiones necesarias para una apertura de la puerta a 90° y 180°.

Measurements needed to open the door at 90° and 180°.



Modularidad y paneles:

- Espesor de 80 y 100 mm
- Modulación 200 mm.
- Cuatro anchos de panel: 400, 800, 1000 y 1200 mm
- Alturas exteriores panel 80: 2160, 2360 y 2560 mm
- Alturas exteriores panel 100: 2200, 2400, 2600
- Longitud máxima del panel 3120 mm (80) 3160 (100)

Modularity and panels:

- Thickness of 80 and 100 mm
- Modulation 200 mm.
- Four panel widths: 400, 800, 1000 and 1200 mm
- Exterior panel heights 80: 2160, 2360 and 2560 mm
- Exterior panel heights 100: 2200, 2400, 2600
- Maximum panel length 3120 mm (80) 3160 (100)



Aislamiento:

- Espuma rígida de poliuretano, libre de CFC e inyectado a alta presión
- Densidad 45 Kg. / m²
- Coeficiente de conductividad térmica 0.022W/mK a 10°C. (Sin envejecimiento)

Insulation:

- Rigid polyurethane foam, CFC-free, injected at high pressure.
- Density 45kg/m².
- Thermal conductivity coefficient 0.022W/mK at 10°C. (Without ageing).



Revestimiento:

- Revestimiento estándar en acero galvanizado prelacado poliéster, con film de protección.
- Color blanco pirineo.
- Calidad alimentaria.

Cladding:

- Galvanized steel cladding pre-lacquered with polyester, with a protective film, as standard.
- Colour white, "blanco pirineo".
- Food grade.



Terminación del Panel de Suelo:

- Suelo reforzado: Idóneo para el tránsito de personas y carretillas manuales. Acabado interior de contrachapado de abedul y resina fenólica antideslizante.
- Suelo de acero inoxidable antideslizante aisi 304 18/8.
- Suelo de chapa lacada blanca igual que el resto de paneles.

Floor Panel Finish:

- Reinforced flooring: Ideal for the transit of people and manual trucks. Birch plywood interior finish with non-slip phenolic resin.
- Non-slip stainless steel flooring AISI 304 18/8.
- Metal flooring lacquered white the same as the rest of the panels.



Perfil sanitario perimetral:

- Diseño cóncavo, dos piezas más tapones esquineros en las uniones
- Base de fijación fabricada en PVC alta resistencia y dispuesta en ángulo
- Perfil sanitario rígido en su parte central y flexible en los extremos para adaptarse al panel
- Esquinas rematadas con tapón de diseño semiesférico para dar continuidad al perímetro sanitario

Perimetral sanitary profile:

- Concave design, two pieces and corner plugs for the joints
- Base profile made of high resistance PVC and angled
- Rigid sanitary profile in its central part and flexible at the ends
- Finishing corners with a hemispherical design cap, let to continuity the sanitary perimetral structure



Sistema de Unión:

- Vástago giratorio, encajable en alojamiento con sistema de sujeción por presión, llave incluida, fabricado en ABS de alta resistencia.

Panel fixings:

- Swivel stem, nestable in housing with a pressure clamping system, key included, made of high resistance ABS.



Puerta:

- Pivotante con apertura a mano derecha, puede colocarse en los 4 lados de la cámara
- Bultete desmontable con ajuste perimetral sobre el marco, asegura la estanqueidad
- Hueco de luz de puerta 1850 x 800 mm
- Sólo en panel 100 mm: resistencia eléctrica antiescarcha colocada en el marco del panel de puerta con caja de conexiones
- Panel puerta y la puerta, están aisladas con el mismo poliuretano empleado en el resto de paneles
- Bisagras de gran calidad y resistencia
- Cierre de un punto de presión, con llave exterior y desbloqueo interior

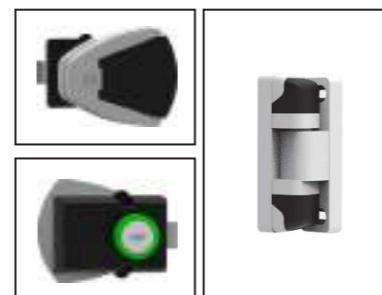

Door:

- Pivoting door with right-hand opening, can be placed on all 4 sides of the cold room
- Removable gasket with perimeter adjustment on the frame, ensures tightness
- Door passthrough 1850 x 800 mm
- Only for panel 100: electric frost resistance on the door panel frame with connections box
- Door panel and door are insulated with the same polyurethane used in the whole structure
- High quality and resistant hinges
- Locking of a pressure point, with external key and internal release



Accesorios incluidos:

- Válvula compensadora de presiones para todas las cámaras de espesor 100
- Perfil sanitario postizo
- Perfil "U" de montaje para cámaras sin panel de suelo
- Luz interior
- Llave hexagonal con mango para montaje de las fijaciones de paneles
- Caja de conexiones y resistencia marco sólo en puerta para panel 100



Parts included:

- Pressure compensation valve for all chambers of thickness 100
- Detachable sanitary profile
- Mounting "U" profile for cameras without floor panel
- Interior light
- Hexagonal wrench with handle for mounting panel fixings
- Junction box and resistance frame only in door for panel 100

OPCIONES bajo pedido

- Otras calidades y colores para el revestimiento del panel tanto para el exterior como en el interior
- Suelo con acabado interior en acero inoxidable antideslizante
- Suelo con acabado blanco pirineo, igual al resto de paneles
- Equipo frigorífico
- Estanterías de aluminio y polietileno de fabricación propia.
- Resistencia eléctrica en cámaras de espesor 80 mm.
- Puerta apertura a mano izquierda (estándar abre a mano derecha)
- Puerta corredera 1850 x 800 mm
- Huecos de puerta, abatible o corredera, con anchos especiales: 600, 700, 900 y 1000 mm
- Hacha de bombero
- Soporte hacha
- Alarma hombre atrapado
- Rampa para puerta abatible o corredera
- Rastreles para separación entre el panel inferior y el suelo

OPTIONS on request

- Other qualities and colors for the panel covering both for the exterior and interior
- Floor with non-slip stainless steel interior finish
- Floor with a white pyrenean finish, the same as the other panels
- Refrigeration equipment
- Self-made aluminum and polyethylene shelves.
- Electrical resistance in chambers of thickness 80 mm.
- Door open on the left (standard opens on the right)
- Sliding door 1850 x 800 mm
- Door openings, pivoting or sliding, with special widths: 600, 700, 900 and 1000 mm
- Fire ax
- Ax support
- Trapped man alarm
- Ramp for swing or sliding door
- Tracks for separation between bottom panel and base floor



ESTANTERÍAS MODULARES realizadas con una estructura de aluminio anodizado y parrillas de polietileno, aptas para el uso con productos alimentarios.

Con nuestras Estanterías y sus múltiples combinaciones conseguirá una óptima eficiencia en la organización y almacenaje. Los materiales empleados en su construcción, la hacen especialmente adecuadas para su uso en cámaras frigoríficas.

MODULAR SHELVING UNITS made with an anodized aluminium structure and polyethylene wire shelves, suitable for food storage.

Our Shelving Units and their multiple combinations will enable you to efficiently store and organise your products. The materials used to build the units make them especially durable for use in cold room.

Características técnicas:

- Especialmente diseñadas para uso alimentario.
- Estructura de aluminio anodizado que proporciona gran rigidez al conjunto.
- Parrillas fabricadas en polietileno calidad alimentaria.
- Tornillería utilizada en su construcción de acero inoxidable.
- Máxima modularidad que la hace adaptable a todos los espacios.
- Dos Fondos de estantes, 400 ó 500 mm.
- Tres alturas, con estantes regulables cada 150 mm.
- También recomendadas para el uso en cámaras frigoríficas, tanto para temperaturas positivas como negativas.
- No se necesita ningún tipo de herramientas para su montaje.

Technical specifications:

- Specifically designed for use with food products.
- Strong anodized aluminium structure.
- Wire shelves are made of food grade polyethylene.
- Assembled using stainless steel screws.
- Maximum modularity making the units adaptable to all spaces.
- Two shelf depths, 400 or 500mm.
- Three heights, with adjustable shelves every 150mm.
- Also recommended for use in cold rooms, for both plus and minus temperatures.
- No tools are needed for assembly.



Parrillas: Fácil montaje y desmontaje. Máxima higiene. <Las parrillas se pueden lavar en lavavajillas convencional.

Wire shelves: Easy assembly and disassembly. Maximum hygiene. Wire shelves can be washed in a conventional dishwasher.



Soportes ángulo: Posibilitan el montaje en ángulo de la estantería otorgándole gran modularidad. Angle brackets: Make it possible to mount shelving units at an angle providing a high amount of flexibility.



Montaje: Fácil montaje. Todas las piezas encajan a la perfección sin necesidad de herramientas. Assembly: Easy assembly. All pieces fit together perfectly without the need for tools.



Pies: Con regulación en altura para salvar posibles desniveles del suelo. Feet: Adjustable feet for uneven floors.

ALTURA 1370 mm.
FONDO 400 Ó 500 mm.
3 ó 4 NIVELES

HEIGHT 1370mm
DEPTH 400 or 500mm
3 or 4 SHELVES

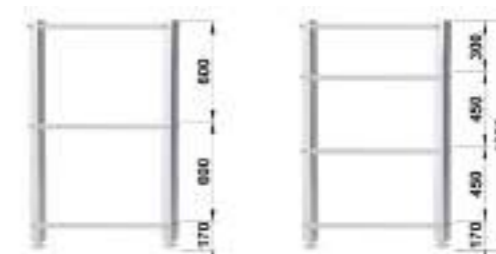

ALTURA 1670 mm.
FONDO 400 Ó 500 mm.
3 ó 4 NIVELES

HEIGHT 1670mm
DEPTH 400 or 500mm
3 or 4 SHELVES



ALTURA 1970 mm.
FONDO 400 Ó 500 mm.
3,4 ó 5 NIVELES

HEIGHT 1970mm
DEPTH 400 or 500mm
3, 4 or 5 SHELVES



Separación mínima
150 mm

150 mm
min. distance

LONGITUD DE ESTANTERÍAS LINEALES INDIVIDUALES. COMPOSICIÓN DE ESTANTES.
LENGTH OF INDIVIDUAL LINEAR SHELVING UNITS. SHELF ASSEMBLY.

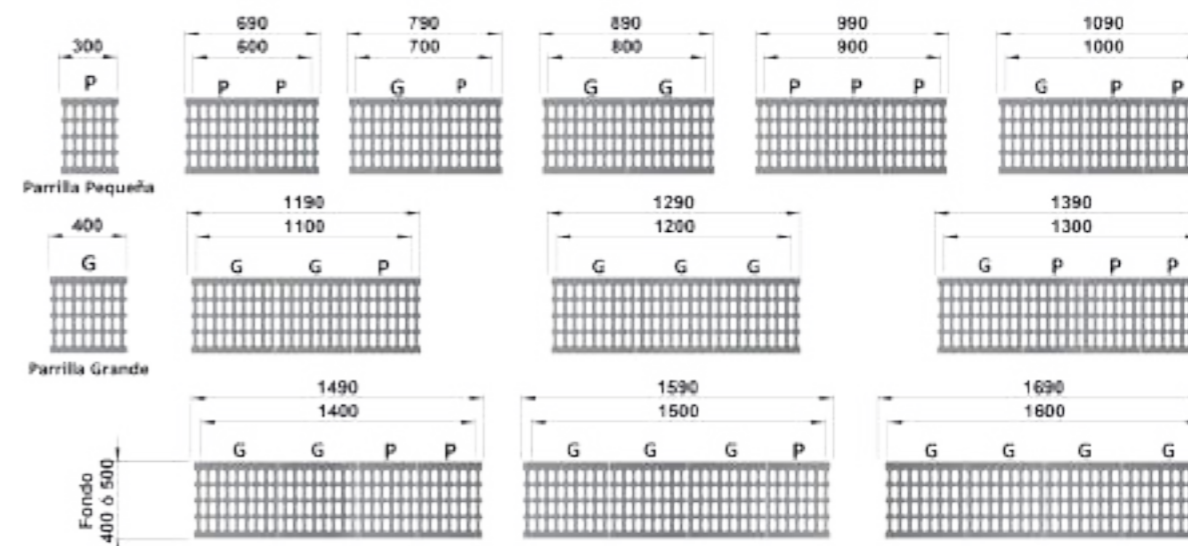

En las tablas de la siguiente página, se identifica el modelo del recinto correspondiente con el espesor de aislamiento (80 / 100 mm) y las medias en planta (largo y fondo).

Este código le dirigirá a la página correspondiente, donde en base a la altura y tipo de suelo, podrá determinar código y precio del recinto.

También se identifica en la tabla particular para cada configuración, el volumen interior de la cámara, lo cual le ayudará a seleccionar el equipo frigorífico apropiado.

The tables on the following page show the corresponding room model with an insulation thickness of 80/100mm and its floor measurements (length and width).

Use the code to locate the corresponding page, where based on the height and type of floor, you can determine the code and price of the room.

For each room layout the table also gives its interior volume, to help you to select the appropriate refrigerator equipment.

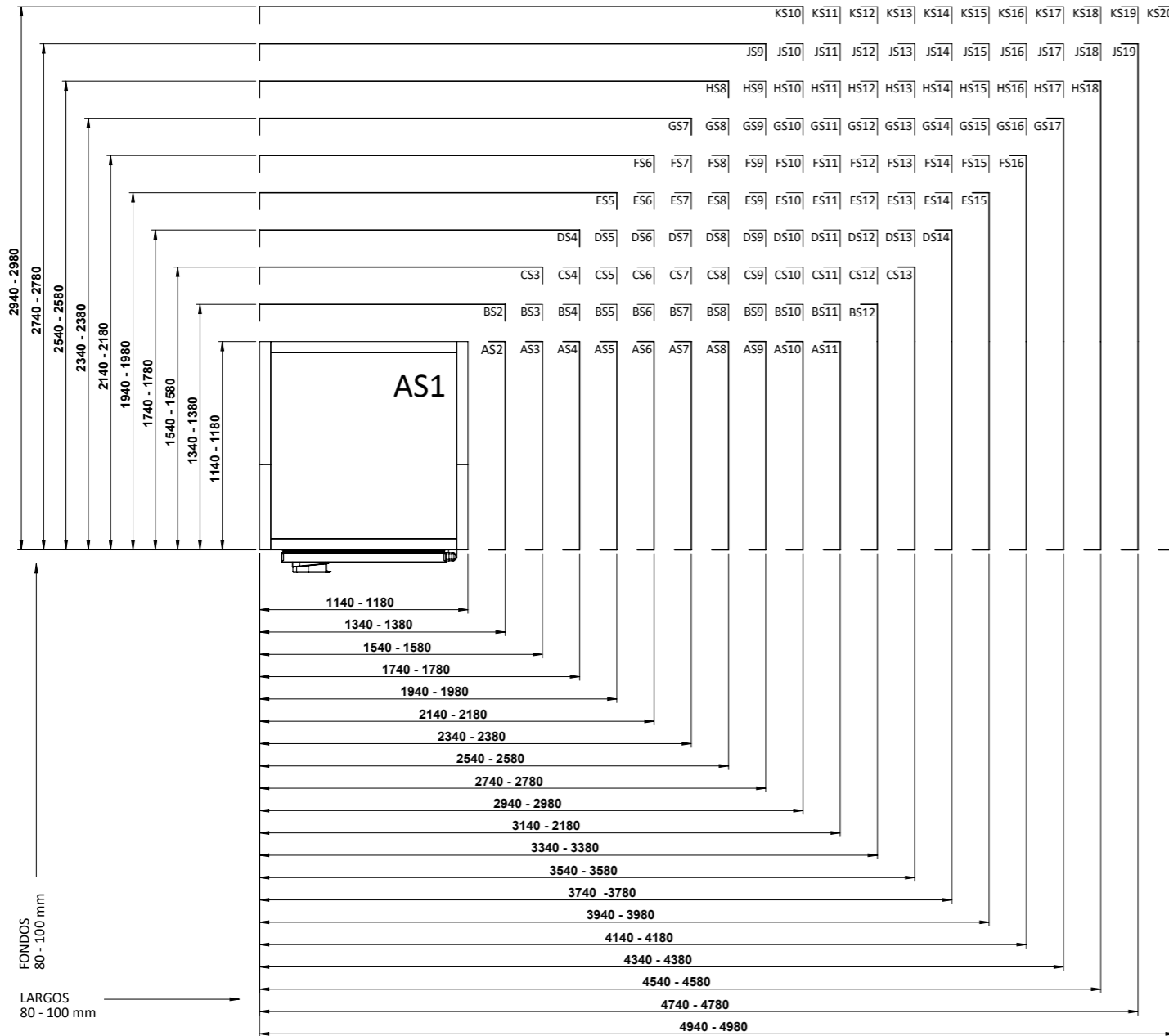

80		Largo - Length (L) mm																				
		1140	1340	1540	1740	1940	2140	2340	2540	2740	2940	3140	3340	3540	3740	3940	4140	4340	4540	4740	4940	
Fondo - Depth mm	1140	AS1	AS2	AS3	AS4	AS5	AS6	AS7	AS8	AS9	AS10	AS11										
	1340		BS2	BS3	BS4	BS5	BS6	BS7	BS8	BS9	BS10	BS11	BS12									
	1540			CS3	CS4	CS5	CS6	CS7	CS8	CS9	CS10	CS11	CS12	CS13								
	1740				DS4	DS5	DS6	DS7	DS8	DS9	DS10	DS11	DS12	DS13	DS14							
	1940					ES5	ES6	ES7	ES8	ES9	ES10	ES11	ES12	ES13	ES14	ES15						
	2140						FS6	FS7	FS8	FS9	FS10	FS11	FS12	FS13	FS14	FS15	FS16					
	2340								GS7	GS8	GS9	GS10	GS11	GS12	GS13	GS14	GS15	GS16	GS17			
	2540									HS8	HS9	HS10	HS11	HS12	HS13	HS14	HS15	HS16	HS17	HS18		
	2740										JS9	JS10	JS11	JS12	JS13	JS14	JS15	JS16	JS17	JS18	JS19	
	2940											KS10	KS11	KS12	KS13	KS14	KS15	KS16	KS17	KS18	KS19	KS20

100		Largo - Length (L) mm																				
		1180	1380	1580	1780	1980	2180	2380	2580	2780	2980	3180	3380	3580	3780	3980	4180	4380	4580	4780	4980	
Fondo - Depth mm	1180	AS1	AS2	AS3	AS4	AS5	AS6	AS7	AS8	AS9	AS10	AS11										
	1380		BS2	BS3	BS4	BS5	BS6	BS7	BS8	BS9	BS10	BS11	BS12									
	1580			CS3	CS4	CS5	CS6	CS7	CS8	CS9	CS10	CS11	CS12	CS13								
	1780				DS4	DS5	DS6	DS7	DS8	DS9	DS10	DS11	DS12	DS13	DS14							
	1980					ES5	ES6	ES7	ES8	ES9	ES10	ES11	ES12	ES13	ES14	ES15						
	2180						FS6	FS7	FS8	FS9	FS10	FS11	FS12	FS13	FS14	FS15	FS16					
	2380							GS7	GS8	GS9	GS10	GS11	GS12	GS13	GS14	GS15	GS16	GS17				
	2580								HS8	HS9	HS10	HS11	HS12	HS13	HS14	HS15	HS16	HS17	HS18			
	2780									JS9	JS10	JS11	JS12	JS13	JS14	JS15	JS16	JS17	JS18	JS19		
	2980										KS10	KS11	KS12	KS13	KS14	KS15	KS16	KS17	KS18	KS19	KS20	

A la hora de elegir su cámara, tenga en cuenta que la ubicación de la puerta estará siempre colocada en el largo.
At time of choosing your Cold Room, keep in mind that the location of the door will always be placed on the length part of the Cold Room.

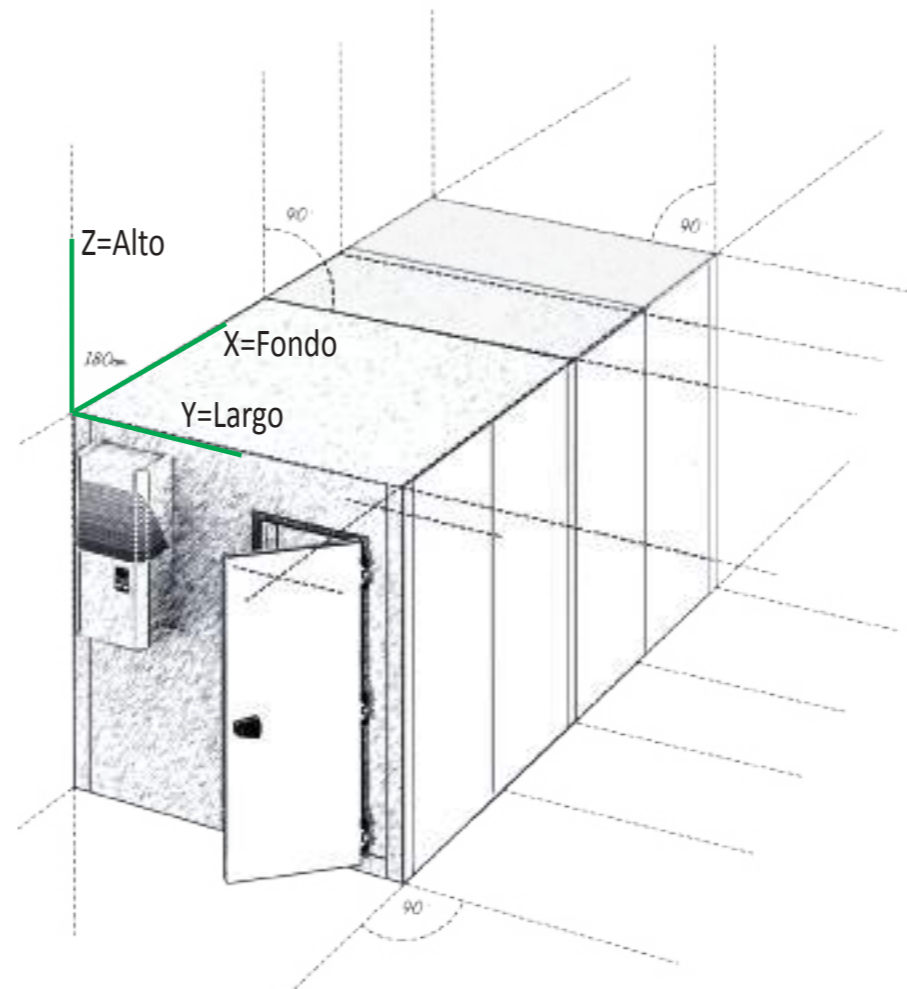

Escanea el código QR o acceda a www.docriluc.es para ver PVP

Scan the QR code or access www.docriluc.es to see PVP

Scannez le code QR ou accédez à www.docriluc.es pour voir PVP



Serie RFM

RECINTOS FRIGORÍFICOS MODULARES
MODULAR COLD ROOMS

Índice de Contenidos / Table of Contents

- PRESENTACIÓN DEL RECINTO FRIGORÍFICO / PRESENTING OUR COLD ROOMS
- DIMENSIONES GENERALES / GENERAL MEASUREMENTS
- CARACTERÍSTICAS TÉCNICAS / TECHNICAL CHARACTERISTICS
- ESTÁNDAR DE FABRICACIÓN Y OPCIONES / STANDARD MANUFACTURING AND OPTIONS
- MODELOS DE PLANTA, MODULARIDAD / FLOOR MODELS, MODULARITY



DOCRILUC le presenta su nueva gama de Recintos Frigoríficos Modulares GAMA RFM, hemos desarrollado una nueva gama de Recintos Frigoríficos Modulares. Desde la concepción del producto, pasando por el diseño, fabricación, embalaje y comercialización... hemos dedicado la máxima atención y esfuerzo incluso a los detalles mas pequeños. En nuestra fabricación empleamos maquinaria sofisticada controladas por computadora y personal bien cualificado. El resultado es una Recinto Frigorífico con personalidad propia y adaptado al mercado actual.

DOCRILUC presents GAMA RFM, its new range of modular cold rooms. In our new DOCRILUC facility, we have developed a new range of modular cold rooms. From the conception of the product, through to the design, manufacturing, packaging and marketing... we have dedicated maximum attention and effort to even the smallest of details. During manufacturing we employ sophisticated computer-controlled machinery and well-qualified personnel. The result is a Cold Room with an original concept suited to today's market.

SECCIÓN Y ALTURAS. / HEIGHTS AND SECTIONS.

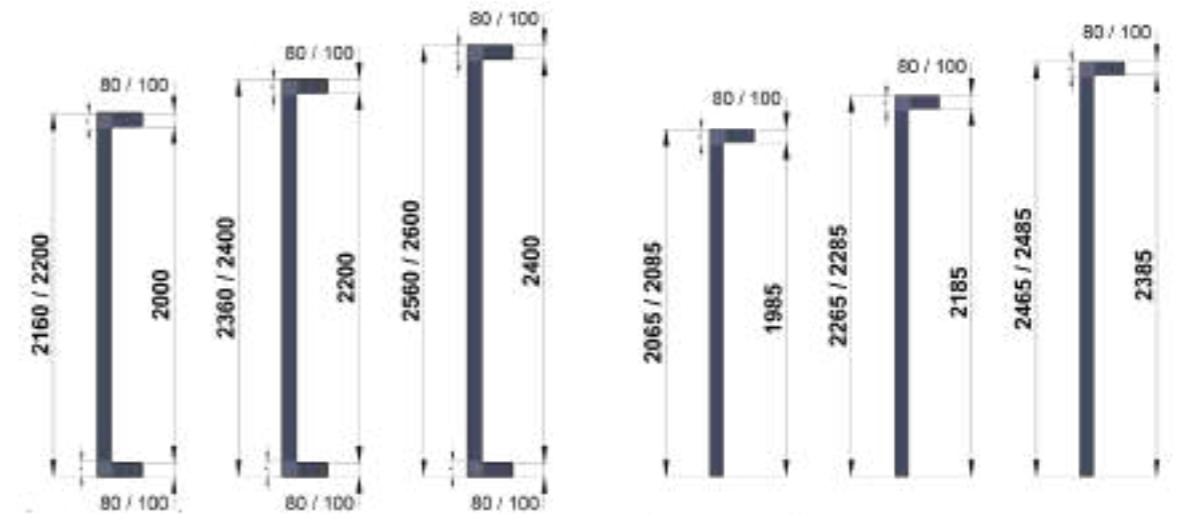

CON suelo panel
WITH floor panel

SIN suelo panel
WITHOUT floor panel

Dimensiones de la columna para espesor 80 mm. Column size for 80mm thickness.

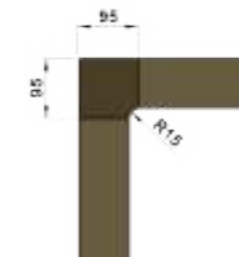

Dimensiones de la columna para espesor 100 mm. Column size for 100mm thickness.

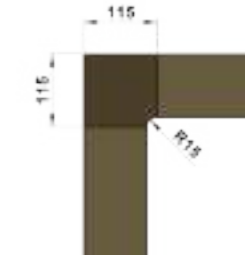

ESPACIOS NECESARIOS PARA UNA CORRECTA INSTALACIÓN. Recomendamos en todos los casos una buena nivelación del suelo donde va a ser ubicado el Recinto Frigorífico. Preveer que el lugar de ubicación permite el acceso del panel de mayor dimensión.

SPACE NEEDED FOR CORRECT INSTALLATION. We recommend a level and even floor for where the Cold Room will be located. Ensure that the location allows access with the largest panel.

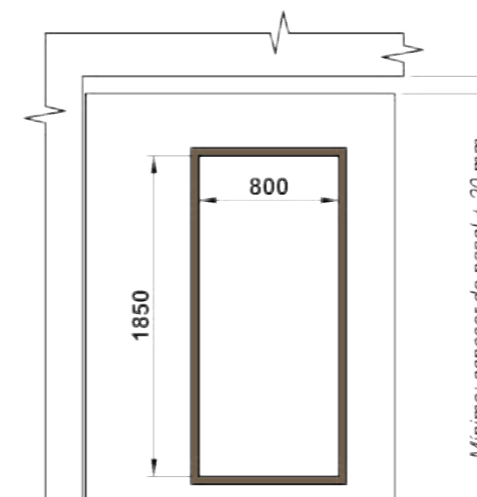

*Representación sobre dimensiones estandar.
*View with standard measurements..

Para poder realizar un montaje correcto es necesario dejar entre el techo del local y el techo del recinto al menos el espesor del panel + 20 mm. For correct assembly, leave at least the thickness of a panel + 20mm between the roof of the premises and the roof of the room.

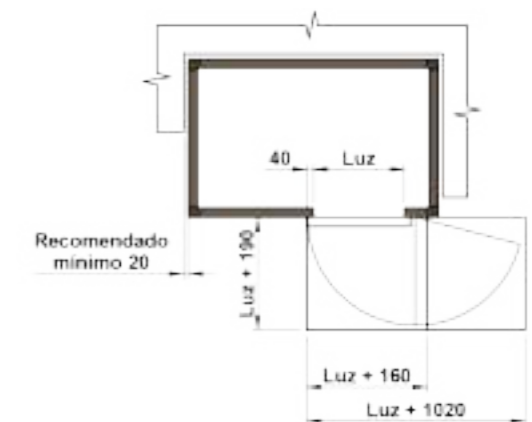

Dimensiones necesarias para una apertura de la puerta a 90° y 180°. Measurements needed to open the door at 90° and 180°.

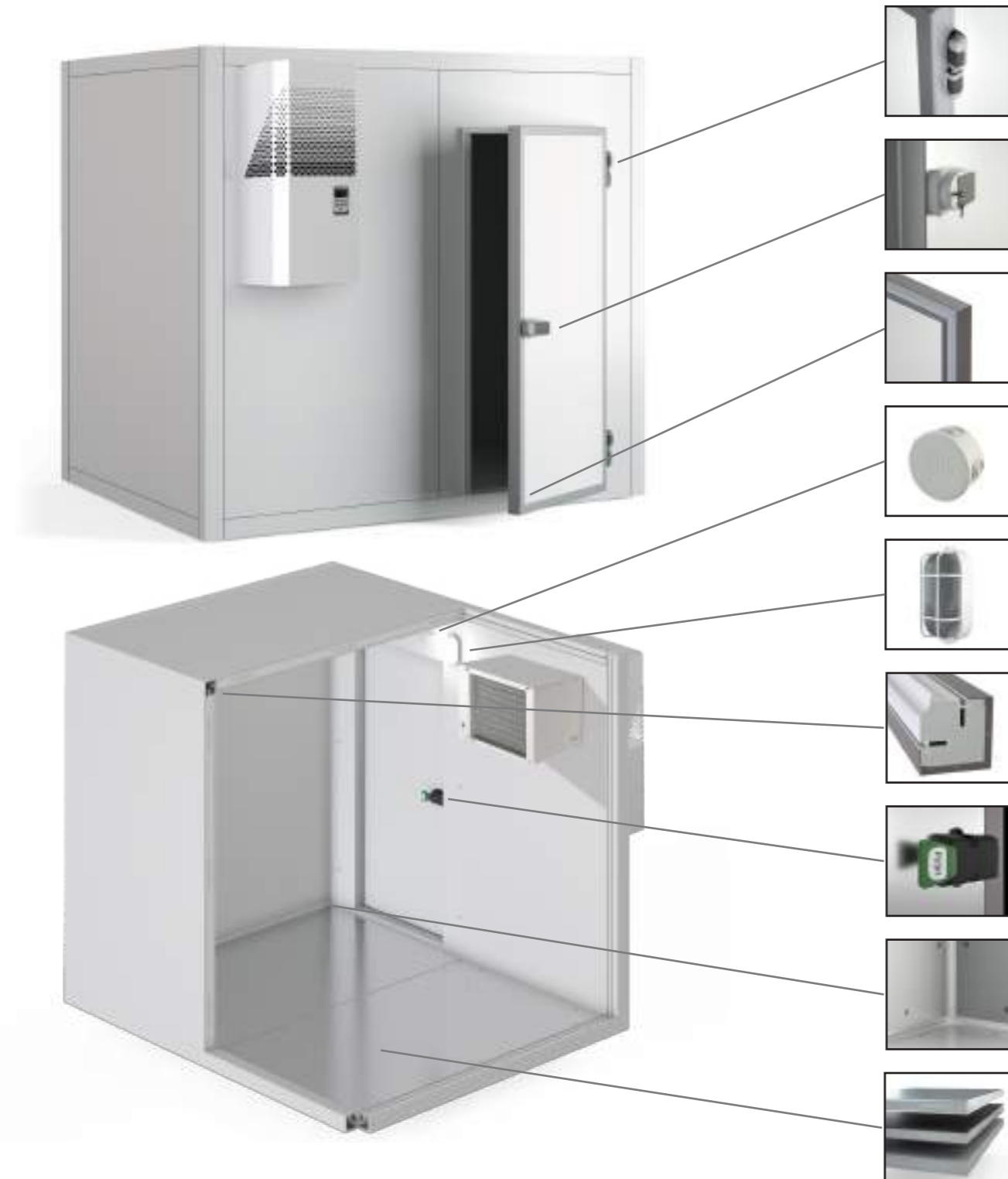



Paneles:

- Espesor de 80 y 100 mm.
- Modularidad 400, 800, 1000 y 1200 mm facilita la adaptabilidad a las dimensiones de su recinto.
- Longitud máxima del panel 3000 mm.

Panels:

- 80 and 100mm thickness.
- 400, 800, 1000 and 1200mm modules to suit the size of your room.
- Maximum panel length 3000mm.



Revestimiento:

- Revestimiento estándar en acero galvanizado prelacado poliéster, con film de protección.
- Color blanco pirineo.
- Calidad alimentaria.

Cladding:

- Galvanized steel cladding pre-lacquered with polyester, with a protective film, as standard.
- Colour white, "blanco pirineo".
- Food grade.



Aislamiento:

- Espuma rígida de poliuretano, libre de CFC e inyectado a alta presión
- Densidad 45 Kg. / m²
- Coeficiente de conductividad térmica 0.022W/mK a 10°C. (Sin envejecimiento)

Insulation:

- Rigid polyurethane foam, CFC-free, injected at high pressure.
- Density 45kg/m².
- Thermal conductivity coefficient 0.022W/mK at 10°C. (Without ageing).



Terminación del Panel de Suelo:

- Suelo reforzado: Idóneo para el tránsito de personas y carretillas manuales. Acabado interior de contrachapado de abedul y resina fenólica antideslizante.
- Suelo de acero inoxidable antideslizante aisi 304 18/8.
- Suelo de chapa lacada blanca igual que el resto de paneles.

Floor Panel Finish:

- Reinforced flooring: Ideal for the transit of people and manual trucks. Birch plywood interior finish with non-slip phenolic resin.
- Non-slip stainless steel flooring AISI 304 18/8.
- Metal flooring lacquered white the same as the rest of the panels.



Sistema de Unión:

- Mecanismo de ganchos excéntricos de alta resistencia y doble efecto (gira y recoge), colocados en carcassas de ABS. El conjunto está pensado para trabajar de dos maneras: engancha y puede ser enganchado.

Connecting System:

- High resistance and double effect eccentric hooks mechanism (turns and locks), installed in ABS housings. The combination is designed to work in two ways: it engages and can be hooked.



Columnas verticales y horizontales:

- Columnas perimetrales con innovador perfil sanitario de labio flexible
- Unión perfecta de gran calidad.
- Revestimiento exterior en el mismo material usado en los paneles
- Línea estética regular en toda la cámara.
- Conjunto inyectado con poliuretano

Vertical and horizontal columns:

- Perimeter columns with innovative sanitary flexible lip seal.
- High quality perfect joints.
- Exterior cladding in the same material as the panels.
- Regular aesthetic line throughout the room.
- Everything is injected with polyurethane.



Modularidad:

- Dos espesores: 80 y 100 mm.
- Modulación 200 mm.
- Tres alturas exteriores diferentes

Modularity:

- Two thicknesses: 80 and 100mm.
- Modulation 200mm.
- Three different external heights.



Puerta:

- Marco perimetral exterior de aluminio anodizado anticorrosión.
- Bultete de estanqueidad.
- Hueco de luz 1850 x 800 mm.
- Resistencia eléctrica antiescarpa colocada en el marco del panel de puerta.
- Tanto el panel puerta como la puerta están inyectados en su interior con el mismo aislamiento del resto de paneles.
- Bisagras con regulación y pasador inoxidable.
- Cierre con llave y con un punto de presión.



Door:

- Exterior perimeter frame made of anodized anti-corrosion aluminium.
- Sealing gasket.
- A light shaft of 1850mm and 800mm.
- Frost prevention electric resistance placed on door panel frame.
- Both the door panel and the door are injected with the same insulation as the rest of the panels.
- Adjustable hinges with stainless steel pin.
- Locks with key and pressure point.



Accesorios incluidos:

- Válvula compensadora de presiones para todas las cámaras de espesor 100 mm.
- Perfil sanitario con labio flexible incluido en todos los perfiles de columna.
- Perfil "U" de suelo para cámaras sin suelo panel.
- Luz interior de cámara.
- Llave hexagonal con mango de ABS rígido para accionar el gancho excéntricos
- Caja de conexiones.

Parts included:

- Pressure compensating valve for all 100mm thickness rooms.
- Sanitary flexible lip seal included on all column profiles.
- Floor made with 'U' profile for rooms without floor insulation panels.
- Cold room interior light.
- Hex wrench with rigid ABS handle to operate the eccentric hook.
- Connections box.

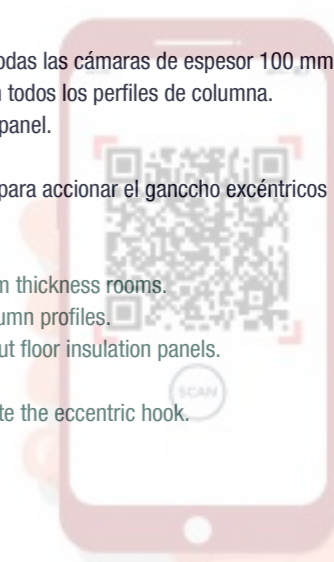

Ofrecemos en nuestra fabricación estándar la máxima calidad y versatilidad.

DOCRILUC diseña, fabrica y comercializa todos sus recintos frigoríficos. Esto nos permite realizar un estudio de las necesidades de cada cliente y ofrecerle la solución mas adecuada.

De serie

- Construcción modular que permite realizar multiples composiciones.
- Totalmente desmontable.
- Ampliable en sus dos sentidos. (hasta un máximo de uno de los sentidos de 3180 y 3230 mm en espesores de 80 y 100 mm respectivamente.)
- Dos espesores de fabricación estándar; 80 y 100 mm.
- Cuatro anchos de panel: 400, 800, 1000 y 1200 mm.
- Modulacion cada 200 mm.
- Tres alturas exteriores diferentes en cámaras de 80 mm.: 2160, 2360, 2560 mm.
- Tres alturas exteriores diferentes en cámaras de 100 mm.: 2200, 2400, 2600 mm.
- Suelo reforzado: Idóneo para el tránsito de personas y carretillas manuales. Acabado interior de contrachapado de abedul y resina fenólica antideslizante.
- Columnas perimetrales de unión entre pared/suelo, pared/techo y pared/pared que incorporan perfil sanitario
- Llave de accionamiento del mecanismo excéntrico de unión.
- Válvula compensadora de presiones en cámaras de mantenimiento de congelados.
- Perfil "U" de pvc en todas las cámaras sunistradas sin suelo panel
- Luz interior.
- Puerta pivotante con apertura derecha que puede colocarse en los cuatro lados de la cámara.
- Huevo de luz de puerta: 1850 x 800 mm.
- Resistencia eléctrica en todos los recintos de espesor 100 mm. y caja de conexiones.
- Bisagras de gran calidad y resistencia.
- Cierre de un punto de presión, con llave y desbloqueo interior.
- Burlete de fácil sustitución en el marco perimetral de la puerta que asegura un cierre estanco.

Opciones

- Fabricación a medida de otras superficies de planta (consultar).
- Fabricación a medida para otras alturas difetentes a las de serie, con una limitación de altura interior 3000 mm.
- Otras calidades de revestimiento de panel, diferentes colores tanto para el exterior como para el interior.
- Suelo con acabado interior en acero inoxidable antideslizante.
- Sin suelo panel.
- Con suelo panel con el mismo acabado que el resto de paneles.
- Equipo de frío.
- Estanterías de aluminio y polietileno de fabricación propia.
- Resistencia eléctrica también en cámaras de espesor 80 mm.
- Puerta con apertura a izquierda. **IMPORTANTE:** No olvidar indicar en pedido la apertura de la puerta, de lo contrario se servirá con apertura a derechas que es nuestro estándar.
- Puerta con otros huecos de luz diferentes al estándar. 600,700,900 y 1.000 mm. de ancho (+160 €)
- Puerta corredera 1850 x 800 mm. Indicar en pedido el sentido de la apertura.(+900 €)
- Puerta corredera con otros huecos de luz diferentes al estándar .600, 700, 900 y 1.000 mm. de ancho (+1.100 €)
- Hacha de bombero (100 €)
- Soporte hacha (35 €)
- Alarma hombre atrapado (290 €)
- Rampa (consultar)

DOCRILUC se reserva el derecho a introducir modificaciones en sus estándares de fabricación así como en sus opciones sin previo aviso y siempre buscando el beneficio del producto final.

We offer the highest quality and versatility in our standard manufacturing.

DOCRILUC designs, manufactures and markets all its cold rooms. This allows us to investigate each of our clients needs and offer the most appropriate solution.

Standard

- Modular construction that allows multiple compositions.
- Can be completely dismantled.
- Expandable in both directions. (up to a maximum of 3180mm in one direction and 3230mm in the other with a thickness of 80 and 100mm.)
- Two standard manufacturing thicknesses: 80 and 100mm.
- Four panel widths: 400, 800, 1000 and 1200mm.
- Modulation every 200mm.
- Three different external heights in rooms measuring 80mm in thickness: 2160, 2360, 2560mm.
- Three different external heights in rooms measuring 100mm in thickness: 2200, 2400, 2600mm.
- Reinforced flooring: Ideal for the transit of people and manual trucks. Birch plywood interior finish with non-slip phenolic resin.
- Perimeter columns connecting wall/floor, wall/ceiling and wall/wall that include a sanitary seal.
- Activation key for eccentric connecting mechanism.
- Pressure compensation valve for frozen room maintenance.
- All rooms without panel flooring have a PVC 'U' profile.
- Interior light
- Pivot door with right opening that can be placed on all four sides of the room.
- Light shaft: 1850 x 800mm
- Electrical resistance in all 100mm thickness rooms and connection box.
- High quality durable hinges.
- Pressure point door locking with key and internal unlocking.
- Easily replaceable perimeter door gasket that ensures a tight seal.

Opciones

- Custom-made floor surfaces (please ask).
- Alternatives heights made to order, with interior height up to 3000 mm.
- Other panel cladding options available in different colours for both the interior and exterior.
- Phenolic birch plywood reinforced panels for wheelbarrow use.
- Without floor panels.
- Floor panels with the same finish as the other panels.
- Cooling unit.
- In-house manufactured aluminium and polyethylene shelving units.
- Electrical resistance also available in 80 mm. thickness rooms
- Left-hand door swing. **IMPORTANT:** Do not forget to indicate when ordering the preferred direction of the door swing, otherwise our standard right-hand door swing will be issued.
- Doors with different light shafts to the standard option. 600, 700 , 900 and 1.000 mm. length (+160 €)

Escanea el código QR o
acceda a www.docriluc.es para ver PVP

Scan the QR code or
access www.docriluc.es to see PVP

Scannez le code QR ou
accéder à www.docriluc.es pour voir PVP



En las tablas de la siguiente página, se identifica el modelo del recinto correspondiente con el espesor de aislamiento (80 / 100 mm) y las medidas en planta (largo y fondo).

Este código le dirigirá a la página correspondiente, donde en base a la altura y tipo de suelo, podrá determinar código y precio del recinto.

También se identifica en la tabla particular para cada configuración, el volumen interior de la cámara, lo cual le ayudará a seleccionar el equipo frigorífico apropiado.

The tables on the following page show the corresponding room model with an insulation thickness of 80/100mm and its floor measurements (length and width).

Use the code to locate the corresponding page, where based on the height and type of floor, you can determine the code and price of the room.

For each room layout the table also gives its interior volume, to help you to select the appropriate refrigerator equipment.

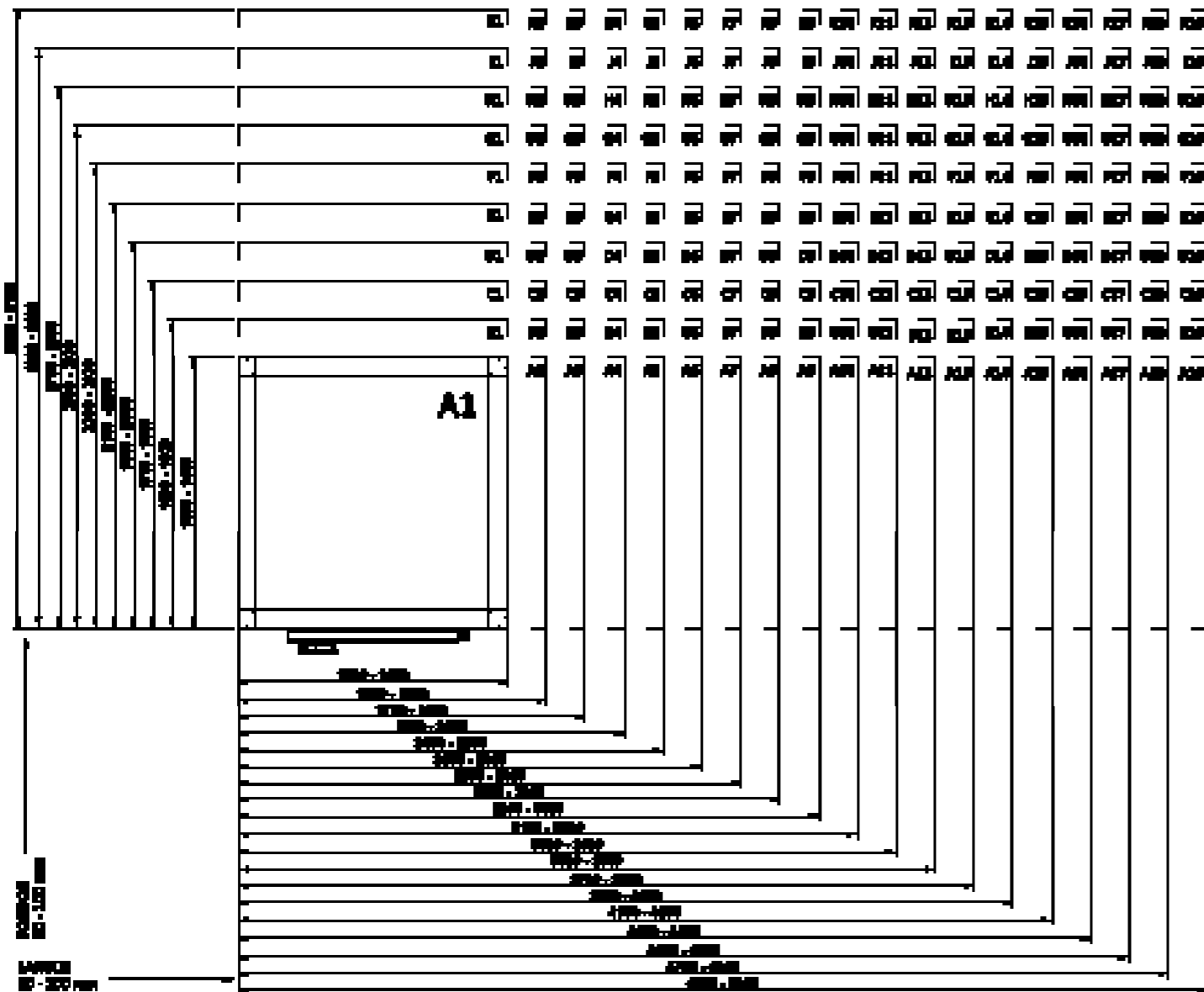

*Ejemplo de elección
D4, 80 mm. : Fondo 1990 mm. Largo 1990 mm.

*Example choices
D4, 80mm.: Depth 1990mm. Length 1990mm.

80		Largo - Length (L) mm																		
		1390	1590	1790	1990	2190	2390	2590	2790	2990	3190	3390	3590	3790	3990	4190	4390	4590	4790	4990
Fondo - Depth mm	1390	A1	A2	A3	A4	A5	A6	A7	A8	A9	A10	A11	A12	A13	A14	A15	A16	A17	A18	A19
	1590	B1	B2	B3	B4	B5	B6	B7	B8	B9	B10	B11	B12	B13	B14	B15	B16	B17	B18	B19
	1790	C1	C2	C3	C4	C5	C6	C7	C8	C9	C10	C11	C12	C13	C14	C15	C16	C17	C18	C19
	1990	D1	D2	D3	D4	D5	D6	D7	D8	D9	D10	D11	D12	D13	D14	D15	D16	D17	D18	D19
	2190	E1	E2	E3	E4	E5	E6	E7	E8	E9	E10	E11	E12	E13	E14	E15	E16	E17	E18	E19
	2390	F1	F2	F3	F4	F5	F6	F7	F8	F9	F10	F11	F12	F13	F14	F15	F16	F17	F18	F19
	2590	G1	G2	G3	G4	G5	G6	G7	G8	G9	G10	G11	G12	G13	G14	G15	G16	G17	G18	G19
	2790	H1	H2	H3	H4	H5	H6	H7	H8	H9	H10	H11	H12	H13	H14	H15	H16	H17	H18	H19
	2990	J1	J2	J3	J4	J5	J6	J7	J8	J9	J10	J11	J12	J13	J14	J15	J16	J17	J18	J19
	3190	K1	K2	K3	K4	K5	K6	K7	K8	K9	K10	K11	K12	K13	K14	K15	K16	K17	K18	K19

100		Largo - Length (L) mm																		
		1430	1630	1830	2030	2230	2430	2630	2830	3030	3230	3430	3630	3830	4030	4230	4430	4630	4830	5030
Fondo - Depth mm	1430	A1	A2	A3	A4	A5	A6	A7	A8	A9	A10	A11	A12	A13	A14	A15	A16	A17	A18	A19
	1630	B1	B2	B3	B4	B5	B6	B7	B8	B9	B10	B11	B12	B13	B14	B15	B16	B17	B18	B19
	1830	C1	C2	C3	C4	C5	C6	C7	C8	C9	C10	C11	C12	C13	C14	C15	C16	C17	C18	C19
	2030	D1	D2	D3	D4	D5	D6	D7	D8	D9	D10	D11	D12	D13	D14	D15	D16	D17	D18	D19
	2230	E1	E2	E3	E4	E5	E6	E7	E8	E9	E10	E11	E12	E13	E14	E15	E16	E17	E18	E19
	2430	F1	F2	F3	F4	F5	F6	F7	F8	F9	F10	F11	F12	F13	F14	F15	F16	F17	F18	F19
	2630	G1	G2	G3	G4	G5	G6	G7	G8	G9	G10	G11	G12	G13	G14	G15	G16	G17	G18	G19
	2830	H1	H2	H3	H4	H5	H6	H7	H8	H9	H10	H11	H12	H13	H14	H15	H16	H17	H18	H19
	3030	J1	J2	J3	J4	J5	J6	J7	J8	J9	J10	J11	J12	J13	J14	J15	J16	J17	J18	J19
	3230	K1	K2	K3	K4	K5	K6	K7	K8	K9	K10	K11	K12	K13	K14	K15	K16	K17	K18	K19

A la hora de elegir su cámara, tenga en cuenta que la ubicación de la puerta estará siempre colocada en el largo.
At time of choosing your Cold Room, keep in mind that the location of the door will always be placed on the length part of the Cold Room.

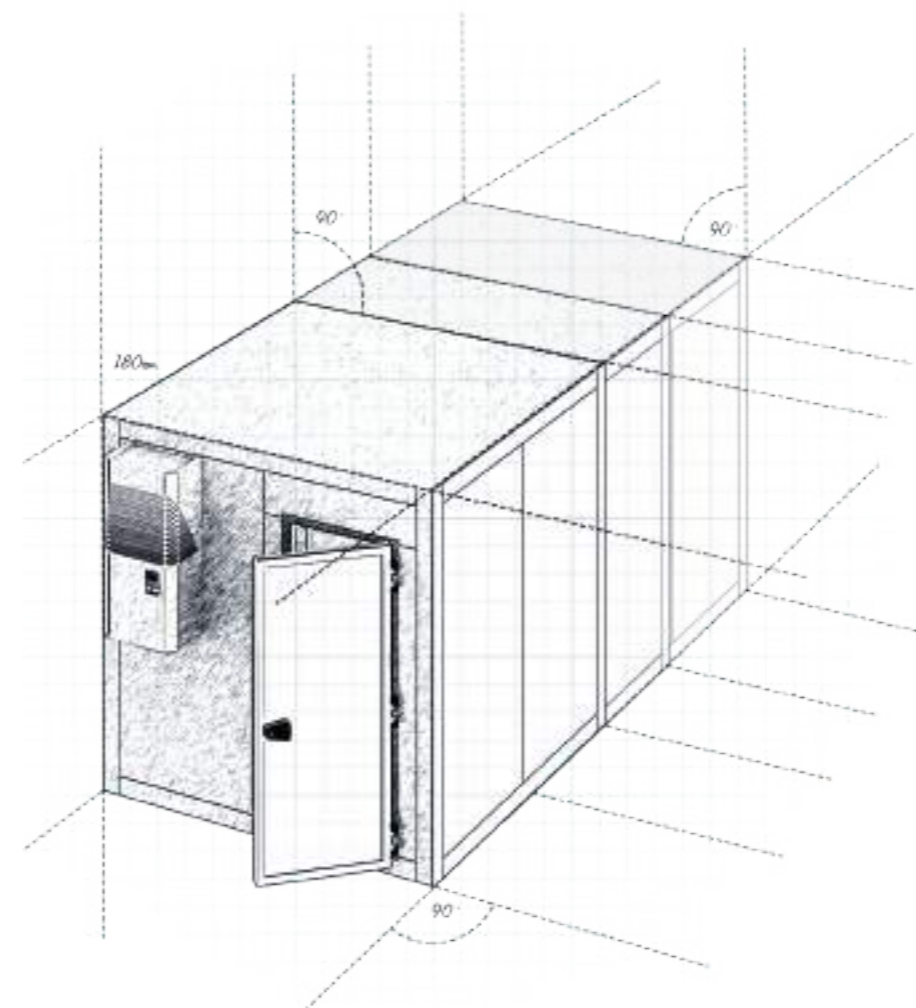

Escanea el código QR o acceda a www.docriluc.es para ver PVP

Scan the QR code or access www.docriluc.es to see PVP

Scannez le code QR ou accédez à www.docriluc.es pour voir PVP



Serie AFD

ARMARIO FRIGORÍFICO DESMONTABLE
MODULAR REACH-IN REFRIGERATOR

Índice de Contenidos / Table of Contents

- ARMARIO FRIGORÍFICO DESMONTABLE / MODULAR REACH-IN REFRIGERATOR
- CARACTERÍSTICAS TÉCNICAS / TECHNICAL SPECIFICATIONS
- ESTÁNDAR DE FABRICACIÓN Y ACCESORIOS / STANDARD DESIGN AND ACCESSORIES
- OTRAS OPCIONES DE CONSTRUCCIÓN / OPTIONAL FEATURES
- ARMARIO FRIGORÍFICO AFD, PUERTAS CIEGAS / SOLID DOOR MODULAR REACH-IN REFRIGERATOR, AFD SERIES
- TABLA DE VALORACIÓN, PUERTAS CIEGAS / SOLID DOOR MEASUREMENT AND PRICING TABLE



DOCRILUC presenta sus nuevos Armarios Frigoríficos Desmontables, GAMA AFD.

Empleamos para su construcción la misma filosofía y materiales que para nuestras Cámaras frigoríficas.

DOCRILUC presents its new AFD Range of Modular Reach-In Refrigerator.

Our modular reach-in refrigerator are manufactured using the same philosophy and materials as our cold rooms.



Características técnicas y constructivas sujetas a variación sin previo aviso
We reserve the right to change specifications without prior notice

Aislamiento:

- Espuma rígida de poliuretano con formulación libre de CFC e inyectado a alta presión
- Densidad 45 Kg. / m²
- Coeficiente de conductividad térmica 0.022W/mK a 10°C. (Sin envejecimiento)

Insulation:

- Rigid polyurethane foam, CFC-free, injected at high pressure.
- Density 45kg/m².
- Thermal conductivity coefficient 0.022W/mK at 10°C. (Without ageing).

Revestimiento:

- Revestimiento estándar de chapa de acero galvanizado prelacado poliéster, con film de protección pelable.
- Color blanco pirineo.
- Calidad alimentaria.

Cladding:

- Galvanized steel cladding pre-lacquered with polyester, with peelable protective film, as standard.
- Colour white, "blanco pirineo".
- Food grade.

Sistema de Unión:

- Mecanismo de ganchos excéntricos de alta resistencia y doble efecto (gira y recoge), colocados en carcasas de ABS. El conjunto está pensado para trabajar de dos maneras: engancha y puede ser enganchado.

Connecting System:

- High resistance and double effect eccentric hooks mechanism (turns and locks), installed in ABS housings. The combination is designed to work in two ways: it engages and can be hooked.

Paneles:

- Espesor de 80 mm.

Panel:

- 80mm thickness.

Columnas verticales y horizontales:

- Columnas perimetrales que incluyen un innovador perfil sanitario con labio flexible que se adapta al panel consiguiendo una unión perfecta de gran calidad y revestidas en su exterior con la misma chapa utilizada en los paneles, consiguiendo así una línea estética regular en toda la cámara.
- Todo el conjunto está inyectado en su interior con poliuretano de las mismas características y densidad que el resto de paneles.

Vertical and horizontal columns:

- Perimeter columns with innovative flexible sanitary lip seal that adapts to fit the panel, combining high quality and an exterior coating made with the same metal sheeting as used to make the panels, thus achieving a uniform appearance throughout the room.
- Everything is injected with polyurethane and has the same characteristics and density as the rest of the panels.

Panel de puerta y Puerta

- Marco perimetral exterior de aluminio anodizado anticorrosión.
- Bulete magnético de estanqueidad.
- Hueco de luz 1700 x 610 mm en puerta 1/1
- Hueco de luz 800 x 610 mm en puerta 1/2
- Resistencia antiescarcha, colocada en el marco del panel puerta en armarios de Mantenimiento de Congelados
- Válvula de compensación de presiones en armarios de Mantenimiento de Congelados
- Tanto el panel puerta como la puerta están inyectados en su interior con el mismo aislamiento del resto de paneles.

Door panel and door:

- Exterior perimeter frame made of anodized anti-corrosion aluminium.
- Magnetic sealing gasket.
- Light shaft of 1700 x 610 mm in 1/1 door.
- Light shaft of 800 x 610mm in 1/2 door.
- Frost prevention resistance installed on the door panel frame in frozen food storage reach-in refrigerators.
- Pressure compensation valve in frozen food storage reach-in refrigerators.
- Both the door panel and the door are injected with the same insulation as the rest of the panels.

Estantes interiores:

- Cremalleras de acero inoxidable con paso de 70 mm.
- Parrillas y guías extraíbles
- Parrillas de acero plastificadas
- 4 niveles de estantes por cuerpo (50kg. carga máxima por nivel)

Interior Shelves:

- Stainless steel supports with 70mm intervals.
- Detachable wire shelves and rails.
- Plastic-coated stainless steel wire shelves.
- 4 shelves per section (load capacities up to 50kg. per level)

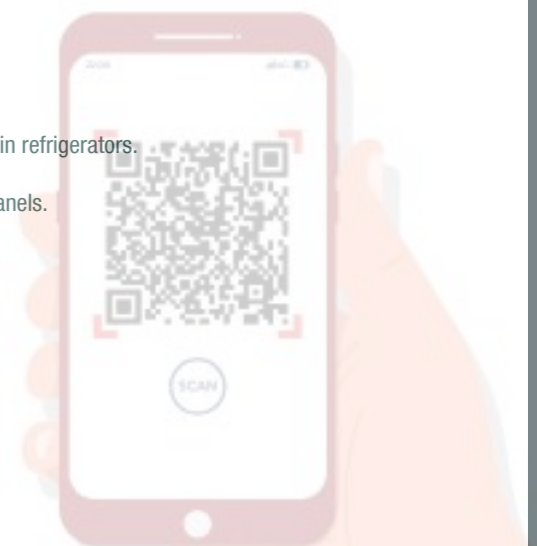

De serie:

- Estantes de 600 x 400 mm.
- 2 estantes por nivel.
- 4 niveles de estantes por cuerpo.
- Separación mínima entre estantes 70 mm.
- Puertas apertura a izquierda.
- 1/2 Puertas apertura a derechas.
- Resistencia antiescarcha y válvula en mantenimiento de congelados.
- Iluminación interior.

Opción:

- Elección de las aperturas de puertas y 1/2 puertas.
- Estantes intermedios
- Tirador con cerradura

Standard:

- Shelves 600 x 400mm.
- 2 shelves per level.
- 4 shelves per section.
- Spacing between shelves 70mm minimum.
- Left door opening.
- 1/2 right door opening.
- No-frost resistance and valve in frozen reach-in units.
- Interior lighting

Optional:

- Choice of door and 1/2 door openings.
- Intermediate shelves
- Locks with key

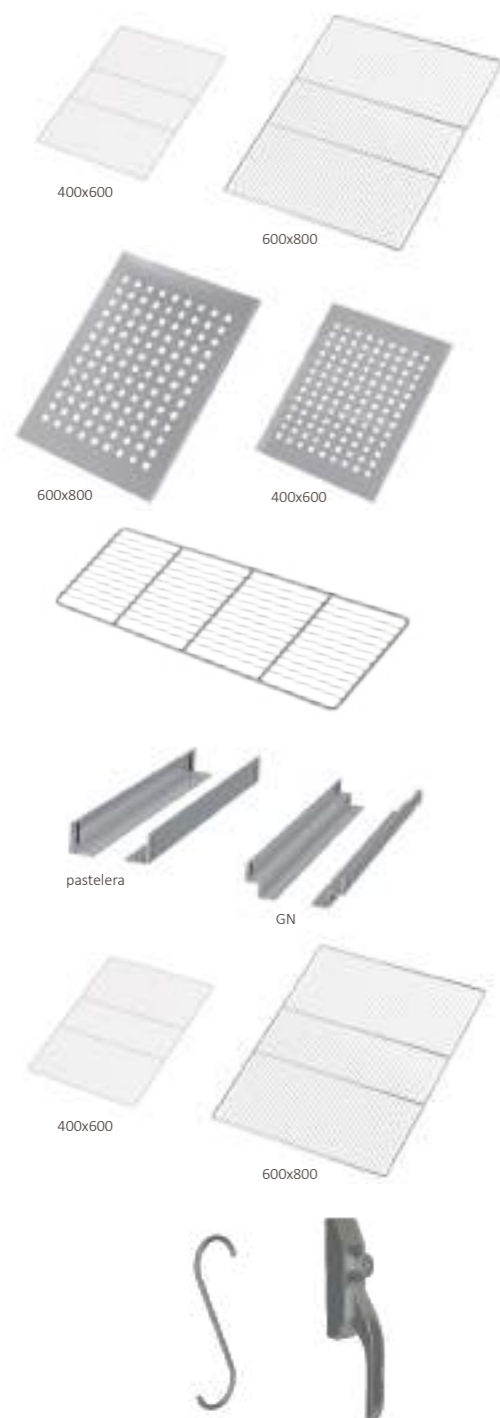

ESTANTES / SHELVES

ARTÍCULO ITEM	DIMENSIONES MEASUREMENTS	ACABADO FINISH	€
PP6080	600 x 800	Ac. plastificado Plastic-coated	57 €
PP6040	600 x 400	Ac. plastificado Plastic-coated	30 €

ESTANTES REFORZADOS EN ACERO INOX REINFORCED STAINLESS STEEL SHELVES

ARTÍCULO ITEM	DIMENSIONES MEASUREMENTS	ACABADO FINISH	€
PR6080	600 x 800	Ac. inoxidable Stainless steel	120 €
PR6040	600 x 400	Ac. inoxidable Stainless steel	82 €

ESTANTES INTERMEDIOS INTERMEDIATE SHELVES

ARTÍCULO ITEM	DIMENSIONES MEASUREMENTS	ACABADO FINISH	€
P17619-AFD	763 x 190	Ac. plastificado Plastic-coated stainless steel	21 €

JUEGO DE GUÍAS / SET OF RAILS

ARTÍCULO ITEM	DIMENSIONES MEASUREMENTS	ACABADO FINISH	€
L	Fondo 800	Ac. inoxidable Stainless steel	46 €
Z	Fondo 800	Ac. inoxidable Stainless steel	58 €

GASTRONORM

ARTÍCULO ITEM	DIMENSIONES MEASUREMENTS	ACABADOS FINISH	€
GN 2/1	530X650	Ac. plastificado Plastic-coated	57 €
GN 1/1	530X325	Ac. plastificado Plastic-coated	29 €
GN 2/1	530X650	Ac. inoxidable Stainless steel	98 €
GN 1/1 I	530X325	Ac. inoxidable Stainless steel	62 €

BARRAS CARNICERAS / MEAT RAILS

ARTÍCULO ITEM	PARA MODELO FOR MODEL	LONGITUD LENGTH	€
BC1	1 CUERPO / DOOR	610	185 €
GC	GANCHO CARNICERO / MEAT HOOKS		19 € x ud
TC	TIRADOR CON CERRADURA / LOCKS WITH KEY		46 € x ud

Nuestros armarios frigoríficos desmontables son tan versátiles como nuestras cámaras por lo que bajo presupuesto permiten otras opciones de construcción:

- Colocación de puertas tanto en el frontal como en la parte trasera.
- Sustitución de un panel de puertas por uno de pared vertical.
- Armarios con o sin dotación interior (guías, parrillas y cremalleras)
- Construcción en diferentes alturas.
- Construcción en panel de espesor 100mm.
- Puerta de cristal 1-1 ó 1-2 en armarios de refrigeración

Our modular reach-in refrigerators are as versatile as our rooms and offer low budget construction options:

- Positioning of doors on both the front and back.
- Replacing a door panel with a vertical wall panel.
- Reach-in refrigerators with or without interior equipment (rails, wire shelves and supports).
- Different heights construction
- 100 mm thickness panel construction.
- Glass door 1-1 or 1-2 for chillers.

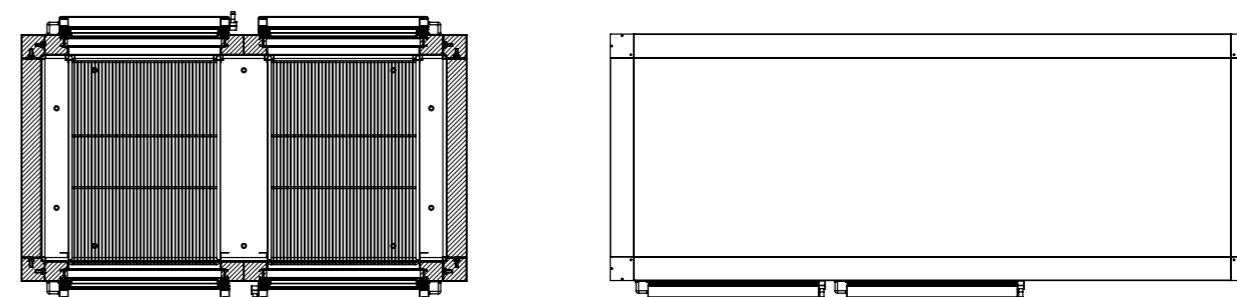

CAMBIO DE PUERTA CIEGA A PUERTA CRISTAL REFRIGERACIÓN SOLID DOOR TO GLASS DOOR REFRIGERATION

ARTÍCULO ITEM	DIMENSIONES MEASUREMENTS	€
P1-1AFDVR	LUZ 610 X 1700	402 €
P1-2AFDVR	LUZ 610 X 800	242 €

Las puertas de cristal se suministrarán con iluminación led
Glass doors supplied with LED lighting

CONFIGURACIÓN DE PUERTAS
DOOR COMPOSITION

De serie:
Estantes de 600 x 400 mm
2 estantes por nivel.
4 niveles de estantes por cuerpo.
Separación mínima entre estantes 70 mm.
Puertas apertura a izquierda.
1/2 Puertas apertura a derechas
Resistencia antiescarcha y válvula en mantenimiento de congelados.
Iluminación interior.

Standard:
Shelves 600 x 400mm.
2 shelves per level.
4 shelves per section.
Spacing between shelves 70mm minimum.
Left door opening.
1/2 right door opening.
Frost prevention resistance and valve in frozen food storage reach-in refrigerator.
Interior lighting

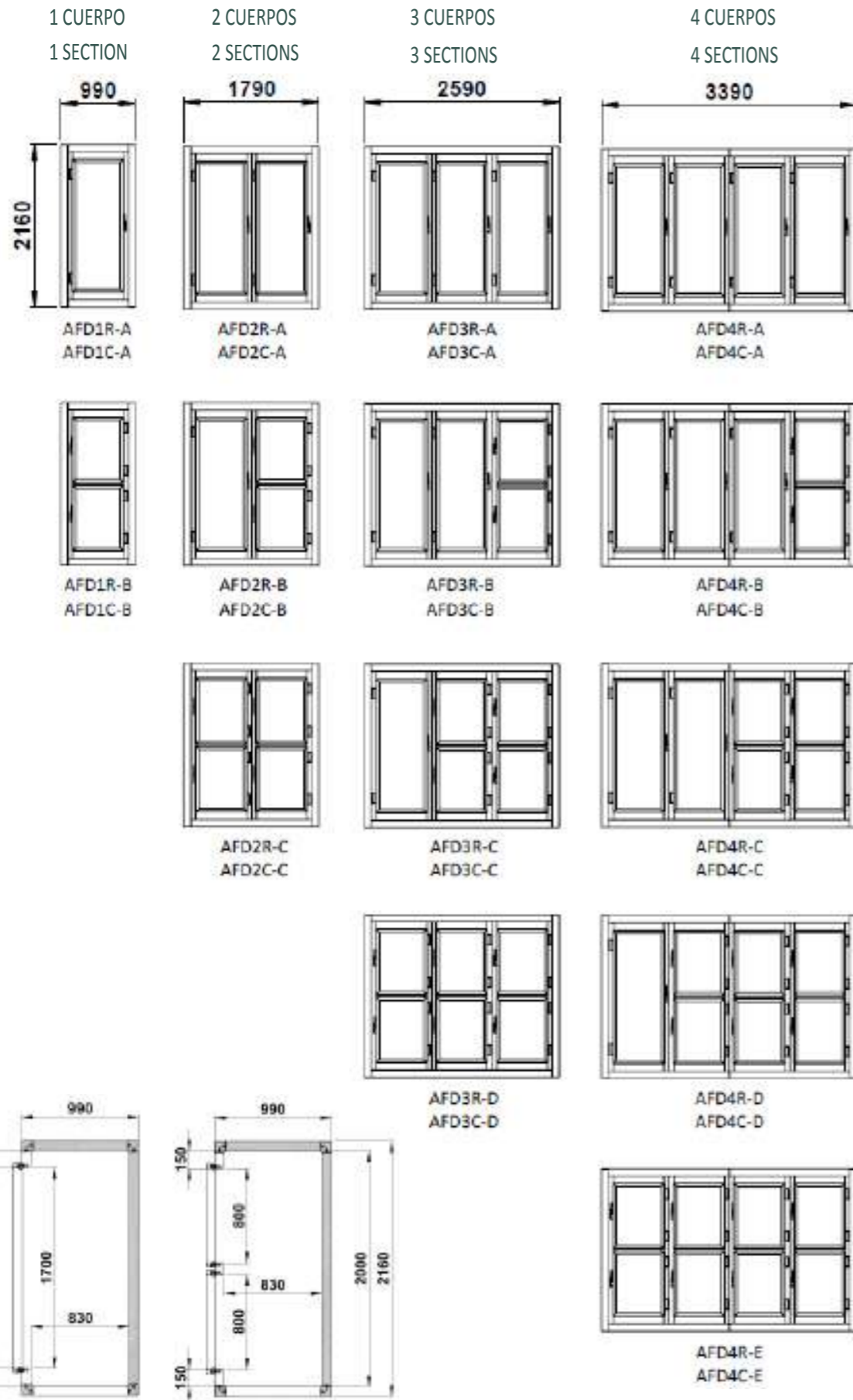

	largo length mm	alto height mm	fondo depth mm	capacidad capacity m³	puertas doors	1/2 puertas half doors	€	
refrigeración - chiller	AFD-1R-A	990	2160	990	1.38	1	-	2.232 €
	AFD-1R-B	990	2160	990	1.38	-	2	2.575 €
	AFD-2R-A	1790	2160	990	2.71	2	-	3.602 €
	AFD-2R-B	1790	2160	990	2.71	1	2	3.946 €
	AFD-2R-C	1790	2160	990	2.71	-	4	4.290 €
	AFD-3R-A	2590	2160	990	4.03	3	-	4.891 €
	AFD-3R-B	2590	2160	990	4.03	2	2	5.227 €
	AFD-3R-C	2590	2160	990	4.03	1	4	5.574 €
	AFD-3R-D	2590	2160	990	4.03	-	6	5.916 €
	AFD-4R-A	3390	2160	990	5.36	4	-	6.172 €
	AFD-4R-B	3390	2160	990	5.36	3	2	6.516 €
	AFD-4R-C	3390	2160	990	5.36	2	4	6.861 €
AFD-4R-D	3390	2160	990	5.36	1	6	7.197 €	
AFD-4R-E	3390	2160	990	5.36	-	8	7.543 €	
congelados - freezer	AFD-1C-A	990	2160	990	1.38	1	-	2.665 €
	AFD-1C-B	990	2160	990	1.38	-	2	2.830 €
	AFD-2C-A	1790	2160	990	2.71	2	-	4.303 €
	AFD-2C-B	1790	2160	990	2.71	1	2	4.462 €
	AFD-2C-C	1790	2160	990	2.71	-	4	4.628 €
	AFD-3C-A	2590	2160	990	4.03	3	-	5.764 €
	AFD-3C-B	2590	2160	990	4.03	2	2	5.930 €
	AFD-3C-C	2590	2160	990	4.03	1	4	6.096 €
	AFD-3C-D	2590	2160	990	4.03	-	6	6.255 €
	AFD-4C-A	3390	2160	990	5.36	4	-	7.236 €
	AFD-4C-B	3390	2160	990	5.36	3	2	7.395 €
	AFD-4C-C	3390	2160	990	5.36	2	4	7.562 €
AFD-4C-D	3390	2160	990	5.36	1	6	7.727 €	
AFD-4C-E	3390	2160	990	5.36	-	8	7.887 €	

Escanea el código QR o accede a www.docriluc.es para ver PVP

Scan the QR code or access www.docriluc.es to see PVP

Scannez le code QR ou accédez à www.docriluc.es pour voir PVP



Serie AFD-PC

ARMARIO FRIGORÍFICO DESMONTABLE
PUERTA DE CRISTAL
MODULAR REACH-IN REFRIGERATOR
GLASS DOOR

Índice de Contenidos / Table of Contents

- ARMARIO FRIGORÍFICO DESMONTABLE PUERTA DE CRISTAL / MODULAR REACH-IN REFRIGERATOR GLASS DOOR
- CARACTERÍSTICAS TÉCNICAS / TECHNICAL SPECIFICATIONS
- ARMARIO FRIGORÍFICO AFD-PC, PUERTAS DE CRISTAL / GLASS DOOR MODULAR REACH-IN REFRIGERATOR, AFD-PC SERIES
- MÓDULOS ESTANERÍAS / SHELVES MODULES



DOCRILUC presenta sus nuevos Armarios Frigoríficos Desmontables, GAMA AFD-PC.

Ideales para la exposición de bebidas y alimentación
Recomendable para condiciones ambientales entre +10 y 33°C con un 65% de humedad relativa.

DOCRILUC presents its new AFD-PC Range of Modular Reach-In Refrigerator.

Perfect for the exhibition of drinks and foods
Recommendable for ambient conditions between +10 and 33°C with a 65% relative humidity.



Características técnicas y constructivas sujetas a variación sin previo aviso
We reserve the right to change specifications without prior notice

Aislamiento:

- Espuma rígida de poliuretano con formulación libre de CFC e inyectado a alta presión
- Densidad 45 Kg. / m²
- Coeficiente de conductividad térmica 0.022W/mK a 10°C. (Sin envejecimiento)

Insulation:

- Rigid polyurethane foam, CFC-free, injected at high pressure.
- Density 45kg/m².
- Thermal conductivity coefficient 0.022W/mK at 10°C. (Without ageing).

Revestimiento:

- Revestimiento estándar de chapa de acero galvanizado prelacado poliéster, con film de protección pelable.
- Color blanco pirineo.
- Calidad alimentaria.

Cladding:

- Galvanized steel cladding pre-lacquered with polyester, with peelable protective film, as standard.
- Colour white, "blanco pirineo".
- Food grade.

Sistema de Unión:

- Mecanismo de ganchos excéntricos de alta resistencia y doble efecto (gira y recoge), colocados en carcasas de ABS. El conjunto está pensado para trabajar de dos maneras: engancha y puede ser enganchado.

Connecting System:

- High resistance and double effect eccentric hooks mechanism (turns and locks), installed in ABS housings. The combination is designed to work in two ways: it engages and can be hooked.

Paneles

- Espesor de 80 mm.

Panels

- 80mm thickness.

Columnas verticales y horizontales:

- Columnas perimetrales que incluyen un innovador perfil sanitario con labio flexible que se adapta al panel consiguiendo una unión perfecta de gran calidad y revestidas en su exterior con la misma chapa utilizada en los paneles, consiguiendo así una línea estética regular en toda la cámara.
- Todo el conjunto está inyectado en su interior con poliuretano de las mismas características y densidad que el resto de paneles.

Vertical and horizontal columns:

- Perimeter columns with innovative flexible sanitary lip seal that adapts to fit the panel, combining high quality and an exterior coating made with the same metal sheeting as used to make the panels, thus achieving a uniform appearance throughout the room.
- Everything is injected with polyurethane and has the same characteristics and density as the rest of the panels.

Puerta

- Marco perimetral exterior de aluminio anodizado anticorrosión color plata.
- Burlete magnético de estanqueidad.
- Hueco de luz 1700 x 610mm en puerta
- Doble cristal en temperatura positiva: vidrio exterior 4mm templado, separador 20mm, vidrio interior 4mm bajo emisivo.
- Triple cristal en temperatura positiva: vidrio exterior 4mm templado bajo emisivo, separador 8mm, vidrio central 4mm, separador 8mm, vidrio interior 4mm bajo emisivo.
- Apertura a derechas (apertura a izquierda bajo pedido)
- Cristales calefactados en temperatura negativa
- Soporte de puertas en acero inoxidable.
- Tirador superpuesto.
- Muelle de retorno automático, con fuerza de retorno ajustable.

Door:

- Perimetral exterior frame, made of aluminium and anodized anti-corrosion, silver colour
- Magnetic sealing gasket.
- Light shaft of 1700 x 610 mm in door.
- Double glazed positive temperatures: exterior tempered glass 4mm, gas 20mm, interior low-e glass 4mm.
- Triple glazed negative temperatures: exterior low-e tempered glass 4mm, gas 8mm, central clear glass 4mm, gas 8mm, interior low-e glass 4mm
- Right opening(optional: left opening)
- Heated glass negative temperature
- Stainless steel door support.
- Superimposed handle.
- Adjustable automatic return spring

Marco

- Marco perimetral exterior de aluminio y PVC anodizado anticorrosión color plata
- Resistencia en el perímetro.

Frame

- Perimetral exterior frame, made of aluminium and anodized anti-corrosion PVC, silver colour
- Frame heating resistance

Iluminación

- LED

Lighting

- LED

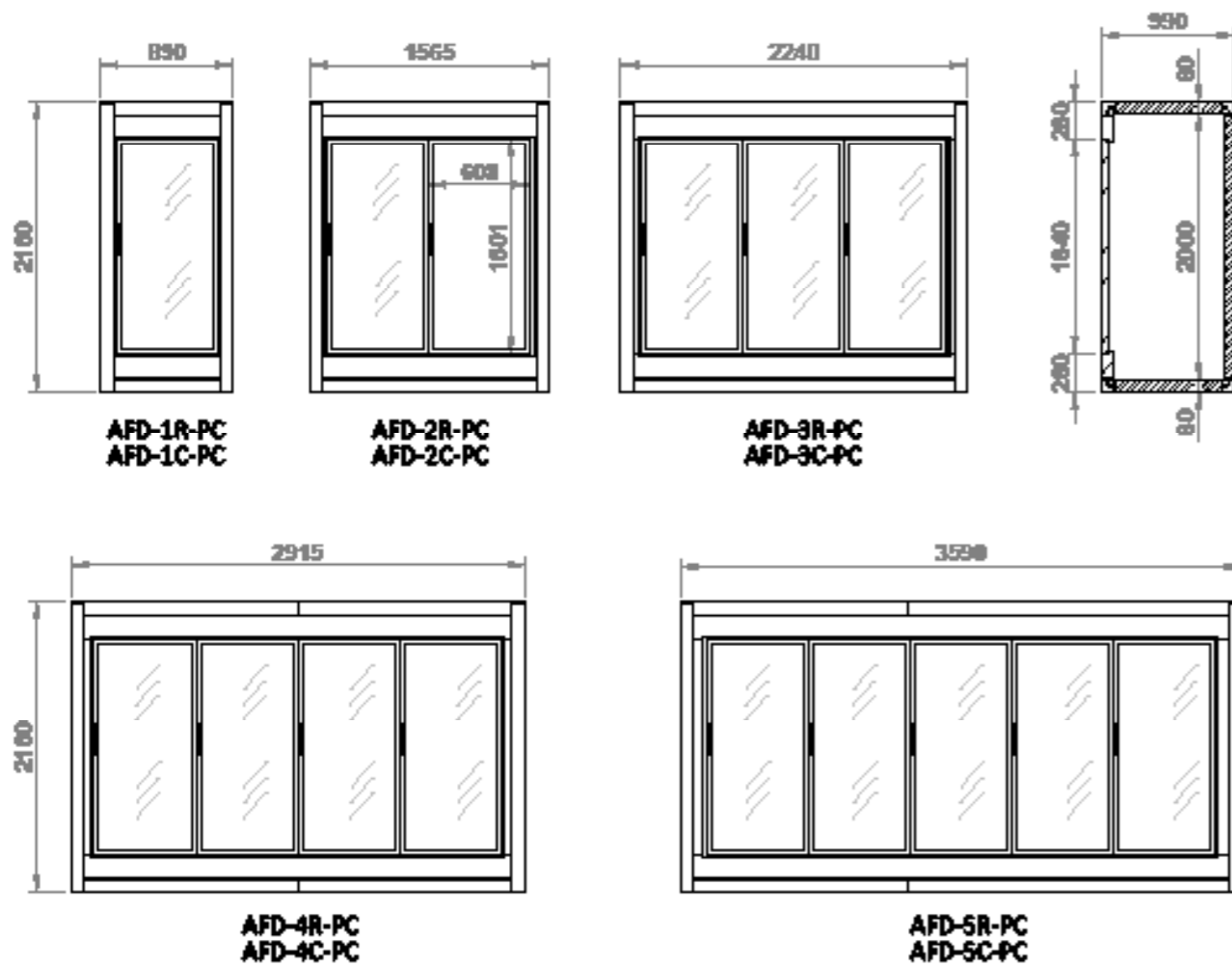

Características técnicas:

- 1 estante base fijo de carga fijo.
- 4 estantes de carga móviles 600x665 regulables en altura (paso 80mm), inclinación (0°, 8° y 16°) y profundidad.
- Barandilla frontal.
- Portaprecios.

Opción:

- Separador lateral blanco o cromado
- Barandilla frontal cromada o metacrilato

Technical characteristics:

- 1 loading level fixed
- 4 moving shelves of loading 600x665 adjustable on height(space 80mm), inclination(0°, 8° y 16°) and depth.
- Front railing
- Price tag

Optional:

- White or Chromed Side separator
- Chromed or Methacrylate front railing



		largo Length mm	alto height mm	fondo depth mm	capacidad capacity m³	puertas doors	1/2 puertas half doors	€
refrigeración- chiller	AFD-1R-PC	890	2160	990	1,21	1	0	3.480 €
	AFD-2R-PC	1565	2160	990	2,33	2	0	4.751 €
	AFD-3R-PC	2240	2160	990	3,48	3	0	6.018 €
	AFD-4R-PC	2915	2160	990	4,57	4	0	7.217 €
	AFD-5R-PC	3590	2160	990	5,69	5	0	8.097 €
congelados- freezer	AFD-1C-PC	890	2160	990	1,21	1	0	3.838 €
	AFD-2C-PC	1565	2160	990	2,33	2	0	5.285 €
	AFD-3C-PC	2240	2160	990	3,48	3	0	6.720 €
	AFD-4C-PC	2915	2160	990	4,57	4	0	8.441 €
	AFD-5C-PC	3590	2160	990	5,69	5	0	9.782 €

Opción:
Alturas diferentes a la estándar: 2360 y 2560
Espesor : 100mm

Optional:
Alternative heights: 2360 and 2560
Thickness: 100 mm

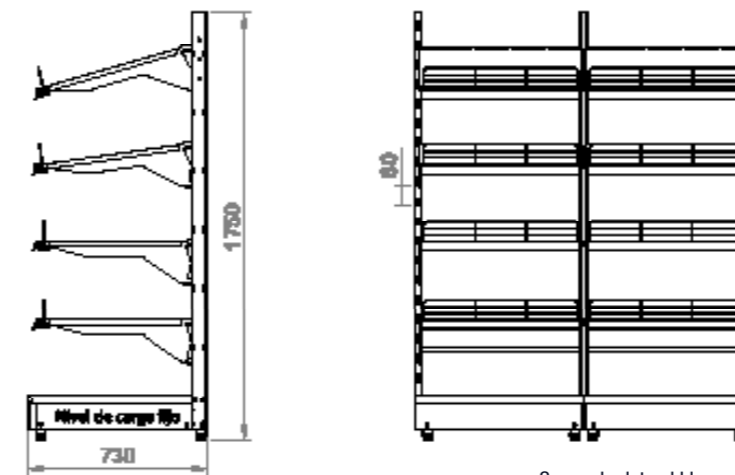

	fondo depth mm	puertas doors	€
módulo estantería shelves module	600	1	1.110 €
	600	2	2.119 €
	600	3	3.108 €
	600	4	4.188 €
	600	5	5.232 €

	Opcinal Optional	€
separador lateral cromado	chromed lateral divider	35 €
barandilla frontal metacrilato	plexy front railing	35 €
barandilla frontal cromada	chromed front railing	35 €

Separador lateral blanco-cromado

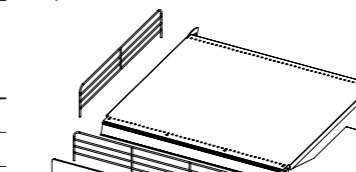

Barandilla frontal blanca - cromada

Barandilla frontal metacrilato

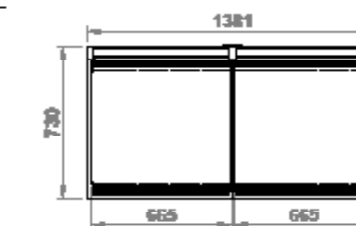

Escanea el código QR o
acceda a www.docriluc.es para ver PVP

Scan the QR code or
access www.docriluc.es to see PVP

Scannez le code QR ou
accéder à www.docriluc.es pour voir PVP



Serie RFM-PC

RECINTOS FRIGORÍFICOS MODULARES

PUERTA DE CRISTAL

GLASS DOOR FOR MODULAR COLD ROOM

Índice de Contenidos / Table of Contents

- CARACTERÍSTICAS TÉCNICAS / TECHNICAL SPECIFICATIONS
- DIMENSIONES GENERALES / GENERAL MEASUREMENTS
- TABLA DE VALORACIÓN / PRICING TABLE





Aislamiento:

- Espuma rígida de poliuretano con formulación libre de CFC e inyectado a alta presión
- Densidad 45 Kg. / m²
- Coeficiente de conductividad térmica 0.022W/mK a 10°C. (Sin envejecimiento)

Insulation:

- Rigid polyurethane foam, CFC-free, injected at high pressure.
- Density 45kg/m².
- Thermal conductivity coefficient 0.022W/mK at 10°C. (Without ageing).

Paneles

- Dos espesores: 80 y 100 mm.

Panels

- Two thickness: 80 and 100 mm.

Características técnicas y constructivas sujetas a variación sin previo aviso

We reserve the right to change specifications without prior notice

Revestimiento:

- Revestimiento estándar de chapa de acero galvanizado prelacado poliéster, con film de protección pelable.
- Color blanco pirineo.
- Calidad alimentaria.

Cladding:

- Galvanized steel cladding pre-lacquered with polyester, with peelable protective film, as standard.
- Colour white, "blanco pirineo".
- Food grade.

Sistema de Unión:

- Mecanismo de ganchos excéntricos de alta resistencia y doble efecto (gira y recoge), colocados en carcasas de ABS. El conjunto está pensado para trabajar de dos maneras: engancha y puede ser enganchado.

Connecting System:

- High resistance and double effect eccentric hooks mechanism (turns and locks), installed in ABS housings. The combination is designed to work in two ways: it engages and can be hooked.

Columnas verticales y horizontales:

- Columnas perimetrales que incluyen un innovador perfil sanitario con labio flexible que se adapta al panel consiguiendo una unión perfecta de gran calidad y revestidas en su exterior con la misma chapa utilizada en los paneles, consiguiendo así una línea estética regular en toda la cámara.
- Todo el conjunto está inyectado en su interior con poliuretano de las mismas características y densidad que el resto de paneles.

Vertical and horizontal columns:

- Perimeter columns with innovative flexible sanitary lip seal that adapts to fit the panel, combining high quality and an exterior coating made with the same metal sheeting as used to make the panels, thus achieving a uniform appearance throughout the room.
- Everything is injected with polyurethane and has the same characteristics and density as the rest of the panels.

Puerta ciega

- Marco perimetral exterior de aluminio anodizado anticorrosión
- Burlete de estanqueidad.
- Huevo de luz 1850 x80010 mm
- Resistencia eléctrica antiescarcha colocada en el marco del panel de puerta.
- Tanto el panel puerta como la puerta están inyectados en su interior con el mismo aislamiento del resto de paneles.
- Bisagras con regulación y pasador inoxidable.
- Cierre con llave y con punto de presión.

Solid door:

- Exterior perimeter frame made of anodized anti-corrosion aluminium.
- Sealing gasket.
- A light shaft of 1850mm and 800mm.
- Frost preventi on electric resistance placed on door panel frame.
- Both the door panel and the door are injected with the same insulati on as the rest of the panels.
- Adjustable hinges with stainless steel pin.
- Locks with key and pressure point.

Puerta cristal

- Marco perimetral exterior de aluminio anodizado anticorrosión color plata.
- Burlete magnético de estanqueidad.
- Huevo de luz 1700 x 610mm en puerta
- Doble cristal en temperatura positiva: vidrio exterior 4mm templado, separador 20mm, vidrio interior 4mm bajo emisivo.
- Triple cristal en temperatura negativa: vidrio exterior 4mm templado bajo emisivo, separador 8mm, vidrio central 4mm, separador 8mm, vidrio interior 4mm bajo emisivo.
- Apertura a derechas (apertura a izquierda bajo pedido)
- Cristales calefactados en temperatura negativa
- Soporte de puertas en acero inoxidable.
- Tirador superpuesto.
- Muelle de retorno automático, con fuerza de retorno ajustable.

Glass door:

- Perimetral exterior frame, made of aluminium and anodized anti-corrosion, silver colour
- Magnetic sealing gasket.
- Light shaft of 1700 x 610 mm in door.
- Double glazed positive temperatures: exterior tempered glass 4mm, gas 20mm, interior low-e glass 4mm.
- Triple glazed negative temperatures: exterior low-e tempered glass 4mm, gas 8mm, central clear glass 4mm, gas 8mm, interior low-e glass 4mm
- Right opening(optional: left opening)
- Heated glass negative temperature
- Stainless steel door support.
- Superimposed handle.
- Adjustable automatic return spring

Marco

- Marco perimetral exterior de aluminio y PVC anodizado anticorrosión color plata
- Resistencia en el perímetro.

Frame

- Perimetral exterior frame, made of aluminium and anodized anti-corrosion PVC, silver colour
- Frame heating resistance

Iluminación

- LED

Lighting

- LED



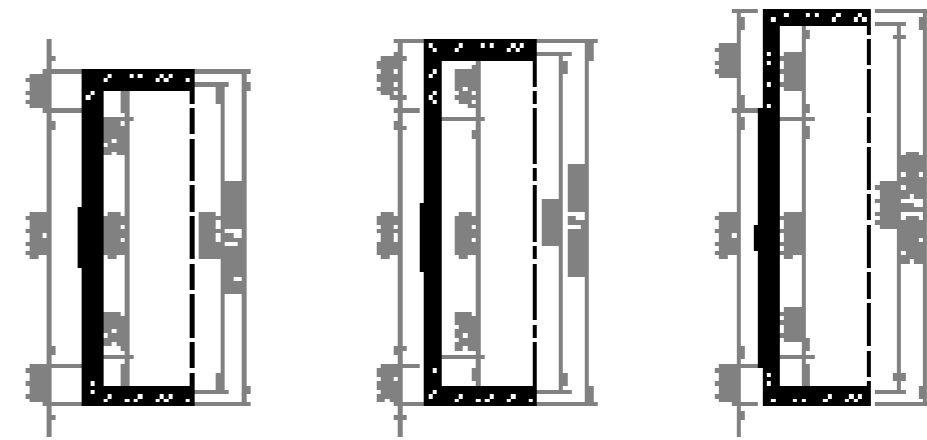
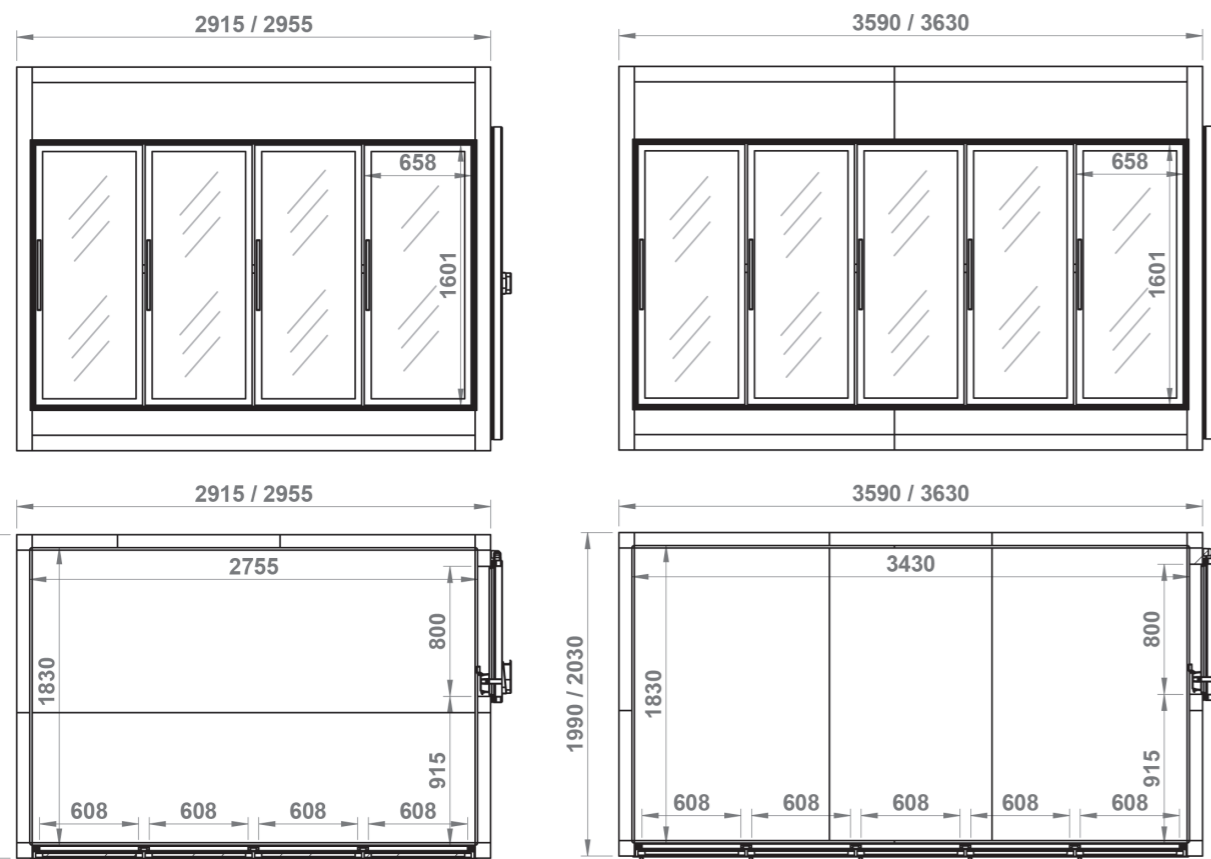
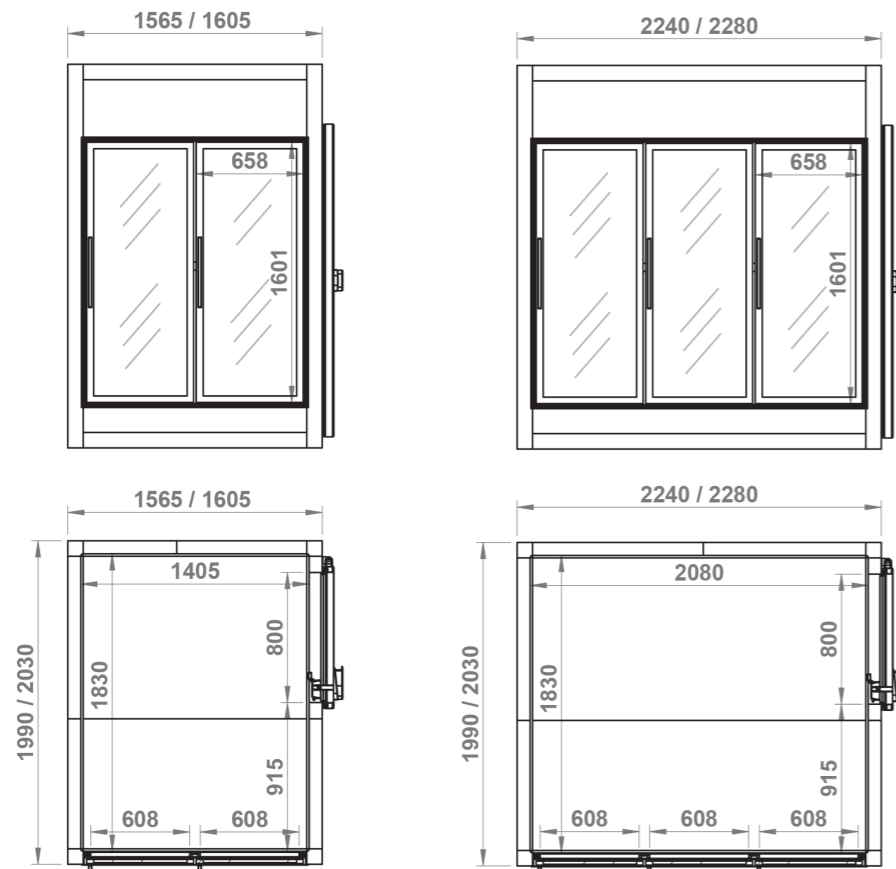

	largo Length mm	alto height mm	fondo depth mm	capacidad capacity m³	puertas doors	11/2 puertas half doors	€	
refrigeración - chiller	RFM2R-PC-A	1565	2160	1990	5,14	2	1	6.159 €
	RFM2R-PC-B	1565	2360	1990	5,62	2	1	6.400 €
	RFM2R-PC-C	1565	2560	1990	6,18	2	1	6.634 €
	RFM3R-PC-A	2240	2160	1990	7,61	3	1	7.679 €
	RFM3R-PC-B	2240	2360	1990	8,32	3	1	7.907 €
	RFM3R-PC-C	2240	2560	1990	9,15	3	1	8.134 €
	RFM4R-PC-A	2915	2160	1990	10,08	4	1	9.015 €
	RFM4R-PC-B	2915	2360	1990	11,02	4	1	9.279 €
	RFM4R-PC-C	2915	2560	1990	12,12	4	1	9.532 €
	RFM5R-PC-A	3590	2160	1990	15,55	5	1	10.057 €
	RFM5R-PC-B	3590	2360	1990	13,72	5	1	10.348 €
	RFM5R-PC-C	3590	2560	1990	15,09	5	1	10.638 €
congelados - freezer	RFM2C-PC-A	1605	2200	2030	5,14	2	1	6.897 €
	RFM2C-PC-B	1605	2400	2030	5,62	2	1	7.149 €
	RFM2C-PC-C	1605	2600	2030	6,18	2	1	7.402 €
	RFM3C-PC-A	2280	2200	2030	7,61	3	1	8.627 €
	RFM3C-PC-B	2280	2400	2030	8,32	3	1	8.866 €
	RFM3C-PC-C	2280	2600	2030	9,15	3	1	9.108 €
	RFM4C-PC-A	2295	2200	2030	10,08	4	1	10.647 €
	RFM4C-PC-B	2295	2400	2030	11,02	4	1	10.919 €
	RFM4C-PC-C	2295	2600	2030	12,12	4	1	11.196 €
	RFM5C-PC-A	3630	2200	2030	15,55	5	1	12.153 €
	RFM5C-PC-B	3630	2400	2030	13,72	5	1	12.473 €
	RFM5C-PC-C	3630	2600	2030	15,09	5	1	12.782 €

Escanea el código QR o acceda a www.docriluc.es para ver PVP

Scan the QR code or access www.docriluc.es to see PVP

Scannez le code QR ou accéder à www.docriluc.es pour voir PVP



Cortinas de Lamas

PVC STRIP CURTAINS

Índice de Contenidos / Table of Contents

- CARACTERÍSTICAS TÉCNICAS / TECHNICAL CHARACTERISTICS
- LISTADOS DE PRECIOS / PRICE LIST



Las cortinas de lamas están formadas por láminas de PVC flexible y transparente solapadas entre sí.

The PVC strip curtains strip are formed by flexible and transparent PVC sheets joined together.

Herrajes fabricados en acero inoxidable aptas el sector del frío industrial.

All fittings and screws are made in stainless Steel and suitable for the industrial refrigeration.

El uso de lamas de PVC flexible es muy útil en puertas frigoríficas para reducir el porcentaje de pérdidas de energía a la hora de cargar y descargar mercancías.

The use of flexible PVC strip are very useful for refrigerating doors. They reduced the lost of energy when you uoload and download the products

La fijación del soporte de lamas puede situarse tanto en el panel puerta como en el techo de la cámara.

The fixing of the PVC strip curtains support can be placed weather in the panel of the door or in the ceilling of the cold room.

Todas las lamas de PVC flexible, pueden ser utilizadas en salas donde se almacenan, preparan, elaboran, etc... los alimentos, incluidos los almacenes donde se cargan las mercancías.

All the PVC strip curtains, can be use in rooms where they can elaborate foods, as well as in warehouses where goods are loaded.

Con un sistema de montaje fácil y sencillo, permite la colocación y sustitución de las lamas de forma rápida y cómoda. Se suministrarán tornillos autorroscantes de acero inoxidable.

Whith an easy assembly system, it allows the place and replacement of the strip in an easily and comfortable way. It is supplied with stainless sets self-tapping screws.

PROPIEDADES PROPERTIES	NORMA TEST METHOD	UNIDAD UNIT	REFRIGERACIÓN CHILLER	CONGELACIÓN FREEZER
Dureza Shore "A" Hardnes	DIN53 505	-	75	65
Densidad específica Specific Density	DIN 53 479	g/cm3	1.22	1.2
Temperatura de servicio Temperature Resistance	-	°C	+50/-20	+35/-40
Flexibilidad Flexibility		°C	35	40
Temperatura de rotura al frío Cold Bend Britt e Point	DIN 53 372	°C	-35	-45
Elongación de rotura Elongation at Break	DIN 53 455	%	360	400
Resistencia a la rotura Tensile Strength	DIN 53 455	n/mm2	17	13
Absorción de agua Water Absorption	DIN 53 472	Mg	17	21
Transparencia Light Transmittance	ASTM D 1003	%	>80	>75
Protección acústica Sound Protection	DIN 52 210	dB	>35	>35
Inflamabilidad / Resistencia al Fuego Flammability/Reaction to Fire	DIN 53 382	-	Autopextinguibles Self-extinguishing	

TODAS NUESTRAS LAMAS RESISTEN LOS RAYOS UV



Características técnicas y constructivas sujetas a variación sin previo aviso
We reserve the right to change specifications without prior notice

Dimensiones luz puerta - Door opening				
	altgo height mm	ancho width mm	€	
refrigeración- chiller	CLR060-185	1850	600	165 €
	CLR070-185	1850	700	191 €
	CLR080-185	1850	800	222 €
	CLR090-185	1850	900	248 €
	CLR0100-185	1850	1000	280 €
	CLR0120-185	1850	1200	331 €
	CLR0140-185	1850	1400	388 €
	CLR0160-185	1850	1600	446 €
	CLR0180-185	1850	1800	502 €
	CLR0200-185	1850	2000	555 €
	CLR060-200	2000	600	173 €
	CLR070-200	2000	700	203 €
	CLR080-200	2000	800	229 €
	CLR090-200	2000	900	261 €
	CLR0100-200	2000	1000	292 €
	CLR0120-200	2000	1200	351 €
	CLR0140-200	2000	1400	407 €
	CLR0160-200	2000	1600	464 €
	CLR0180-200	2000	1800	522 €
	CLR0200-200	2000	2000	579 €
congelados- freezer	CLC060-185	1850	600	209 €
	CLC070-185	1850	700	248 €
	CLC080-185	1850	800	280 €
	CLC090-185	1850	900	319 €
	CLC0100-185	1850	1000	351 €
	CLC0120-185	1850	1200	419 €
	CLC0140-185	1850	1400	497 €
	CLC0160-185	1850	1600	567 €
	CLC0180-185	1850	1800	636 €
	CLC0200-185	1850	2000	707 €
	CLC060-200	2000	600	222 €
	CLC070-200	2000	700	261 €
	CLC080-200	2000	800	300 €
	CLC090-200	2000	900	336 €
	CLC0100-200	2000	1000	369 €
	CLC0120-200	2000	1200	446 €
	CLC0140-200	2000	1400	522 €
	CLC0160-200	2000	1600	592 €
	CLC0180-200	2000	1800	669 €
	CLC0200-200	2000	2000	746 €

Somos fabricantes y así fabricamos Cortinas de Lamas para cualquier dimensión de puerta.
Consultar con nuestro departamento comercial.
We are the manufacturers of the strip curtains, and can supply curtains for any door sizes.
Contact our sales team for a quote.

ESTANTERÍAS

SHELVING UNITS

Índice de Contenidos / Table of Contents

- PRESENTACIÓN DE LA ESTANTERÍA / PRESENTING OUR SHELVING UNITS
- MODULARIDAD Y RESISTENCIA / FLEXIBILITY AND RESISTANCE
- TIPOS DE ESTANTERÍAS / TYPES OF SHELVING UNIT
- DIMENSIONES DE LA ESTANTERÍA / SHELVING UNIT MEASUREMENTS
- COMPONENTES DE LA ESTANTERÍA / SHELVING UNIT COMPONENTS
- ELECCIÓN DE LA ESTANTERÍA / SELECTION OF SHELVING UNITS
- BANCADA / BENCHES
- TABLA DE VALORACIÓN Y COMPOSICIÓN DE CONJUNTOS
- MEASUREMENT AND PRICING TABLE
 - LINEAL FONDO 400 ALTURA 1370 / LINEAR, 400 DEPTH, 1370 HEIGHT
 - ANGULAR FONDO 400 ALTURA 1370 / ANGULAR, 400 DEPTH, 1370 HEIGHT
 - LINEAL FONDO 400 ALTURA 1670 / LINEAR, 400 DEPTH, 1670 HEIGHT
 - ANGULAR FONDO 400 ALTURA 1670 / ANGULAR, 400 DEPTH, 1670 HEIGHT
 - LINEAL FONDO 400 ALTURA 1970 / LINEAR, 400 DEPTH, 1970 HEIGHT
 - ANGULAR FONDO 400 ALTURA 1970 / ANGULAR, 400 DEPTH, 1970 HEIGHT
 - LINEAL FONDO 500 ALTURA 1370 / LINEAR, 500 DEPTH, 1370 HEIGHT
 - ANGULAR FONDO 500 ALTURA 1370 / ANGULAR, 500 DEPTH, 1370 HEIGHT
 - LINEAL FONDO 500 ALTURA 1670 / LINEAR, 500 DEPTH, 1670 HEIGHT
 - ANGULAR FONDO 500 ALTURA 1670 / ANGULAR, 500 DEPTH, 1670 HEIGHT
 - LINEAL FONDO 500 ALTURA 1970 / LINEAR, 500 DEPTH, 1970 HEIGHT
 - ANGULAR FONDO 500 ALTURA 1970 / ANGULAR, 500 DEPTH, 1970 HEIGHT



LE PRESENTAMOS SU ESTANTERÍA:

DOCRILUC le presenta su nueva gama de ESTANTERÍAS MODULARES realizadas con una estructura de aluminio anodizado y parrillas de polietileno, aptas para el uso con productos alimentarios.

Con nuestras Estanterías y sus múltiples combinaciones conseguirá una óptima eficiencia en la organización y almacenaje de su cocina industrial.

Además, los materiales empleados en su construcción, la hacen especialmente adecuadas para su uso en cámaras frigoríficas.

WE PRESENT TO YOU OUR SHELVING UNITS:

DOCRILUC presents its new range of MODULAR SHELVING UNITS made with an anodized aluminium structure and polyethylene wire shelves, suitable for food storage.

Our Shelving Units and their multiple combinations will enable you to efficiently store and organise your industrial kitchen.

Additionally, the materials used to build the units make them especially durable for use in cold room.

Características técnicas:

- Especialmente diseñadas para uso alimentario.
- Estructura de aluminio anodizado que proporciona gran rigidez al conjunto.
- Parrillas fabricadas en polietileno calidad alimentaria.
- Tornillería utilizada en su construcción de acero inoxidable.
- Máxima modularidad que la hace adaptable a todos los espacios.
- Dos Fondos de estantes, 400 ó 500 mm.
- Tres alturas, con estantes regulables cada 150 mm.
- También recomendadas para el uso en cámaras frigoríficas, tanto para temperaturas positivas como negativas.
- No se necesita ningún tipo de herramientas para su montaje.

Technical characteristics:

- Specifically designed for use with food products.
- Strong anodized aluminium structure.
- Wire shelves are made of food grade polyethylene.
- Assembled using stainless steel screws.
- Maximum modularity making the units adaptable to all spaces.
- Two shelf depths, 400 or 500mm.
- Three heights, with adjustable shelves every 150mm.
- Also recommended for use in cold rooms, for both plus and minus temperatures.
- No tools are needed for assembly.



ABSOLUTA MODULARIDAD:

La gran modularidad de la estantería le permite combinar diferentes dimensiones y formas para así adaptarse al espacio disponible de su recinto.

Personalice su estantería agregando, si lo requiere, mas niveles de estantes a los suministrados de manera estándar.

La combinación de medidas y formas diferentes dan como resultado una óptima organización de su area de trabajo y/o almacenaje.

COMPLETE FLEXIBILITY:

The enhanced flexibility of the shelving units allows you to combine different sizes and shapes to adapt to the space available in your room. If required, you can customise your product by adding extra shelves to the standard model.

The combination of different shapes and sizes results in optimal organisation of your work area and/or storage.

From the shelving units available you can configure as many combinations as required.

A partir de la estantería de que disponga, puede llegar a configurar tantas combinaciones como requiera.

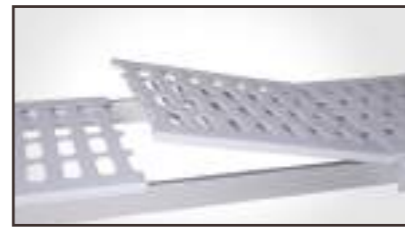

Parrillas: Fácil montaje y desmontaje. Máxima higiene. Las parrillas se pueden lavar en lavavajillas convencional.
WIRE SHELVES: Easy assembly and disassembly. Maximum hygiene. Wire shelves can be washed in a conventional dishwasher.



Soportes ángulo: Posibilitan el montaje en ángulo de la estantería otorgándole gran modularidad.

Angle brackets: Make it possible to mount shelving units at an angle providing a high amount of flexibility.



Montaje: Fácil montaje. Todas las piezas encajan a la perfección sin necesidad de herramientas.
Assembly: Easy assembly. All pieces fit together perfectly without the need for tools.



Pies: Con regulación en altura para salvar posibles desniveles del suelo.
Feet: Adjustable feet for uneven floors.

CAPACIDAD Y RESISTENCIA:

En estantes de hasta 1 metro de longitud, puede almacenar hasta 120 Kgrs. de peso repartidos de forma uniforme. A partir de 1 metro de longitud la carga admisible repartida uniformemente pasa a ser de 100 Kgrs.

CAPACITY AND RESISTANCE:

Shelves up to one metre in length can store a maximum of 120kg of evenly distributed weight. Shelves over one metre in length can withstand a maximum of 100kg of evenly distributed weight.

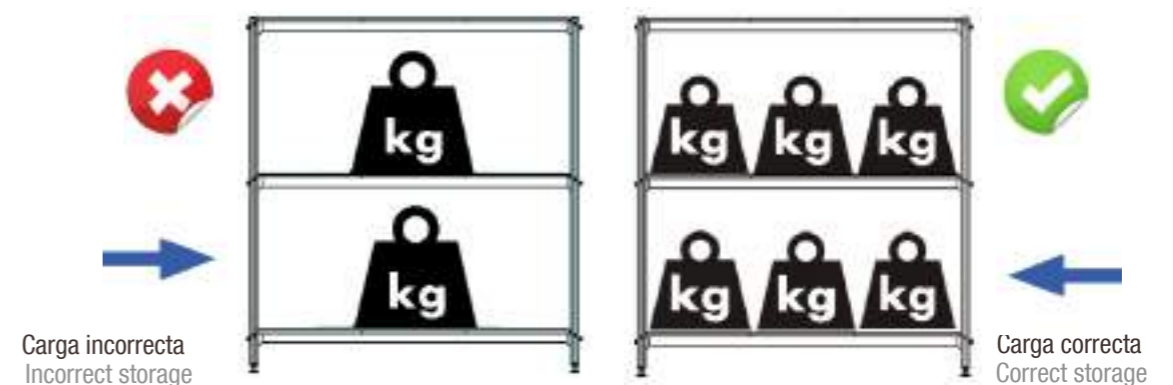

ESTANTERÍA LINEAL. (L)

La Estantería LINEAL es una estantería individual con escaleras soportes en cada extremo.
Esta estantería permite, además de su montaje independiente, múltiples combinaciones mediante la colocación de estanterías complementarias y/o angulares por ambos lados.

LINEAR SHELVING UNITS. (L)

LINEAR Shelving Units are individual units supported by uprights at each end.
This shelving unit allows, in addition to independent assembly, multiple shelving combinations by adding supplementary shelving units and/or angular shelving units on both sides.



ESTANTERÍA COMPLEMENTARIA. (C)

La Estantería COMPLEMENTARIA es una estantería individual con escaleras soportes en SÓLO uno de sus extremos, ya que el otro se une a la escalera de la estantería a la que complementa.
La estantería complementaria puede complementar a una estantería Lineal, a otra Complementaria o a una Angular.

SUPPLEMENTARY SHELVING UNITS. (C)

SUPPLEMENTARY Shelving Units are individual units supported by uprights on ONLY one end as the other end connects to the additional shelving unit.
Supplementary shelving can be added to Linear shelving units, other Supplementary shelving or to Angular shelving units.



ESTANTERÍA ANGULAR. (A)

La Estantería ANGULAR es una estantería individual con escaleras soportes en SÓLO uno de sus extremos. La sujeción del extremo que no tiene escalera se realiza mediante unos soportes de acero inoxidable que facilitan su montaje en ángulo. Estos soportes van incluidos cuando se pide una estantería angular.

ANGULAR SHELVING UNITS. (A)

ANGULAR Shelving Units are individual units supported by uprights on ONLY one side. On the side without uprights, the stainless steel brackets which support the unit are assembled at an angle. These brackets are included when an angular shelving unit is ordered.

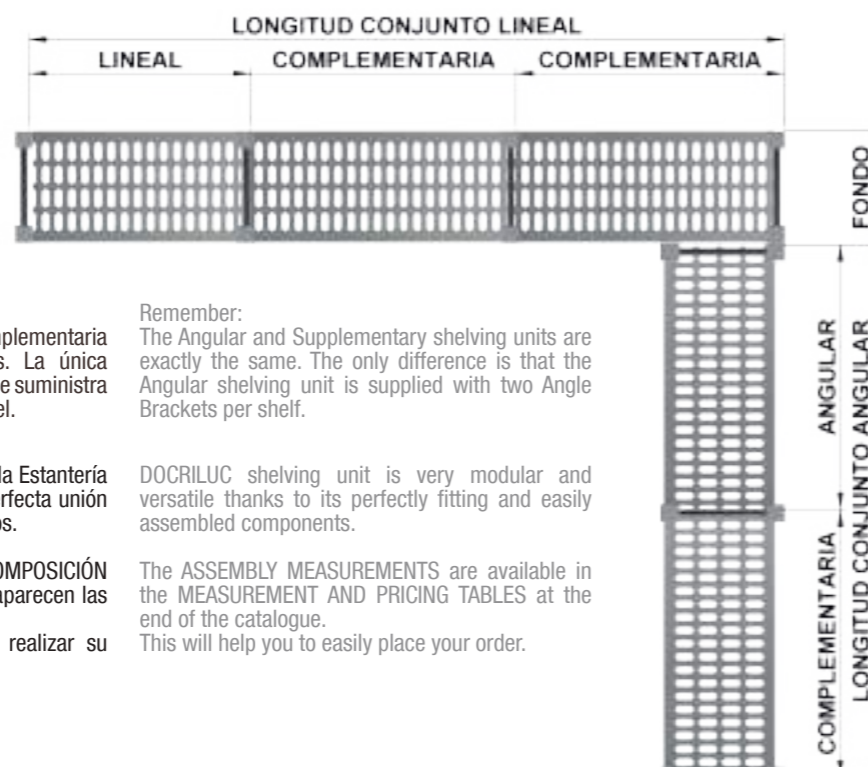
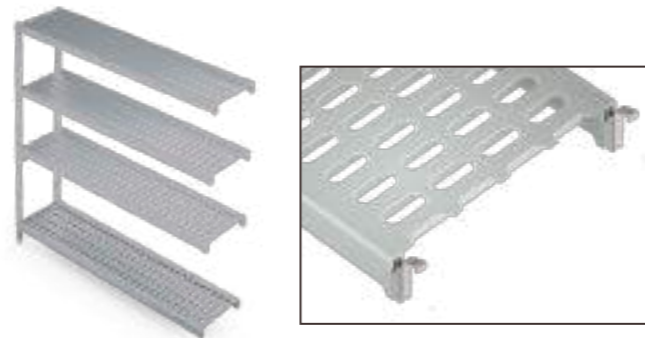

Recuerde:
La estantería Angular y la Complementaria son estanterías exactamente iguales. La única diferencia es que la estantería angular se suministra con dos Soportes Ángulo por cada nivel.

Remember:
The Angular and Supplementary shelving units are exactly the same. The only difference is that the Angular shelving unit is supplied with two Angle Brackets per shelf.

La gran modularidad y versatilidad de la Estantería DOCRILUC se consigue gracias a la perfecta unión y fácil combinación entre sus elementos.

DOCRILUC shelving unit is very modular and versatile thanks to its perfectly fitting and easily assembled components.

En las TABLAS DE VALORACIÓN Y COMPOSICIÓN DE CONJUNTOS, al final de catálogo, aparecen las LONGITUDES DE CONJUNTO. Esto le servirá de gran ayuda para realizar su pedido fácilmente.

The ASSEMBLY MEASUREMENTS are available in the MEASUREMENT AND PRICING TABLES at the end of the catalogue. This will help you to easily place your order.

Recuerde:
Si se requieren mas niveles de estantes de los suministrados de manera estándar, sumar al valor de la estantería el valor del estante correspondiente que aparece en el apartado: COMPONENTES DE LA ESTANTERÍA.

Remember:
If you need more shelves than the amount supplied with the standard product, add the price of the extra shelf or shelving unit to the corresponding price of the unit listed in this section SHELVING UNIT COMPONENTS.

ALTURA 1370 mm.
FONDO 400 Ó 500 mm.
3 ó 4 NIVELES
HEIGHT 1370mm
DEPTH 400 or 500mm
3 or 4 SHELVES

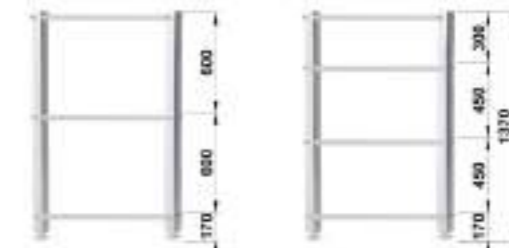

ALTURA 1670 mm.
FONDO 400 Ó 500 mm.
3 ó 4 NIVELES
HEIGHT 1670mm
DEPTH 400 or 500mm
3 or 4 SHELVES



ALTURA 1970 mm.
FONDO 400 Ó 500 mm.
3,4 ó 5 NIVELES
HEIGHT 1970mm
DEPTH 400 or 500mm
3, 4 or 5 SHELVES



LONGITUD DE ESTANTERÍAS LINEALES INDIVIDUALES. COMPOSICIÓN DE ESTANTES.
LENGTH OF INDIVIDUAL LINEAR SHELVING UNITS. SHELF ASSEMBLY.

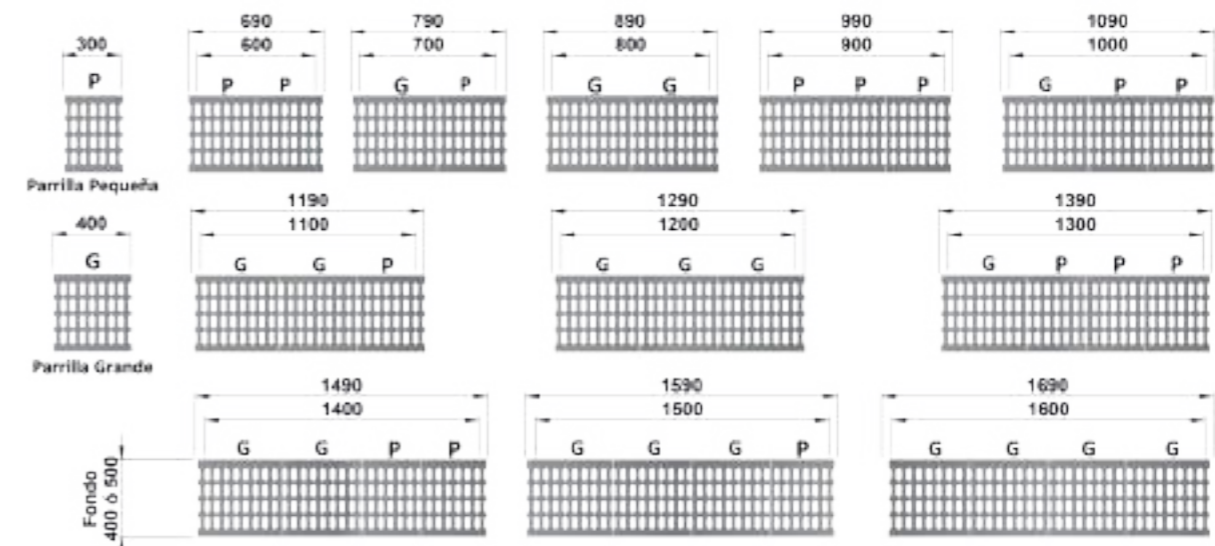

SOPORTES ESCALERAS:

Resistentes y fabricados en aluminio anodizado. De manera estándar se suministran en tres alturas diferentes y para dos fondos, 400 ó 500 mm. En función de su altura se pueden elegir con 3, 4 ó 5 niveles de estantes. Disponen de patas regulables y en todos los casos permiten la regulación de los estantes cada 150 mm. Los Soportes Escaleras se sirven completos, con todos los elementos necesarios para montar los estantes.

SUPPORTING BRACKETS:

Hard-wearing anodised aluminium. The standard product includes three different heights and two depths of 400 or 500mm. Depending on their height, they can be ordered with 3, 4 or 5 individual shelves. They have adjustable feet which allow shelves to be adjusted every 150mm. Supporting uprights are provided with all the necessary components to assemble the shelves.

ESTANTES:

Los Estantes forman los distintos niveles de la estantería. Si necesita incorporar mas niveles a su estantería, nos puede solicitar estantes sueltos. En ese caso no olvide agregar a su pedido los pasadores y soportes ángulo necesarios.

SHELVES:

Shelves form the different levels of the shelving units. If you need to add more shelves to your shelving unit, you can request individual shelves. In that case, don't forget to add the necessary bolts and angle brackets to your order.

FONDO 400 / DEPTH 400

ALTURA HEIGHT	MODELO MODEL	NIVELES SHELVES	€
1370	E137F4-3N	3	75 €
1370	E137F4-4N	4	84 €
1670	E167F4-3N	3	83 €
1670	E167F4-4N	4	91 €
1970	E197F4-3N	3	101 €
1970	E197F4-4N	4	108 €
1970	E197F4-5N	5	117 €

FONDO 500 / DEPTH 500

ALTURA HEIGHT	MODELO MODEL	NIVELES SHELVES	€
1370	E137F5-3N	3	77 €
1370	E137F5-4N	4	85 €
1670	E167F5-3N	3	84 €
1670	E167F5-4N	4	93 €
1970	E197F5-3N	3	105 €
1970	E197F5-4N	4	112 €
1970	E197F5-5N	5	122 €



1370 1670 1970



FONDO 400 / DEPTH 400

LONGITUD LENGTH	MODELO MODEL	€
600	ES600F4	37 €
700	ES700F4	42 €
800	ES800F4	46 €
900	ES900F4	53 €
1000	ES1000F4	58 €
1100	ES1100F4	61 €
1200	ES1200F4	63 €
1300	ES1300F4	66 €
1400	ES1400F4	73 €
1500	ES1500F4	74 €
1600	ES1600F4	76 €



FONDO 500 / DEPTH 500

LONGITUD LENGTH	MODELO MODEL	€
600	ES600F5	42 €
700	ES700F5	48 €
800	ES800F5	53 €
900	ES900F5	59 €
1000	ES1000F5	64 €
1100	ES1100F5	68 €
1200	ES1200F5	72 €
1300	ES1300F5	74 €
1400	ES1400F5	81 €
1500	ES1500F5	84 €
1600	ES1600F5	85 €

Recuerde:
Mas niveles de estantes bajo pedido.
No olvide pedir los pasadores o soportes angulares necesarios.
Remember:
More shelves are available on request.
Do not forget to ask for the necessary bolts or angular brackets.

PARRILLAS:

Fabricadas en polietileno con calidad alimentaria. Podemos suministrarlas como accesorio suelto ya que los Estantes completos incluyen sus parrillas correspondientes.

WIRE SHELVES:

Made using food grade polyethylene. We can supply individual wire shelves as accessories, as the shelf units are supplied with their own.



MODELO / MODEL	€/UD. / € per U.	DESCRIPCIÓN / DESCRIPTION
P400	10 €	Parrilla pequeña Fondo 400 mm. Small wire shelf measuring 400mm in depth
P500	13 €	Parrilla pequeña Fondo 500 mm. Small wire shelf measuring 500mm in depth
G400	13 €	Parrilla grande Fondo 400 mm. Large wire shelf measuring 400mm in depth
G500	14 €	Parrilla grande Fondo 500 mm. Large wire shelf measuring 500mm in depth

PASADORES:

Juego de pasadores (macho + hembra). Fabricados en aluminio, van incorporados a la escalera en función al número de niveles que solicite en su pedido. Son elementos necesarios para poder ampliar el número de estantes de su estantería.

BOLTS:

Set of bolts (male + female). The supporting uprights are put together with aluminium bolts, according to the number of shelves ordered. They are necessary to be able to increase the number of shelves in your shelving unit.



MODELO MODEL	€/ UD. € per U	DOTACIÓN NECESARIA POR ESTANTE EQUIPMENT NEEDED FOR SHELVES
PA	5	4 uds. por estante en estantería LINEAL y/o COMPLEMENTARIA 4 units per shelf in the LINEAR and/or SUPPLEMENTARY shelving units
		2 uds. por estante en estantería ANGULAR 2 units per shelf in the ANGULAR shelving units

SOPORTES ÁNGULO:

Posibilitan el montaje de la estantería en un ángulo de 90°, dotando a la estantería de una gran modularidad.

ANGLE BRACKETS:

These allow the shelving units to be mounted at a 90° angle, making the unit very flexible.

MODELO MODEL	€/UD. € per U.	DOTACIÓN NECESARIA POR ESTANTE EQUIPMENT NEEDED FOR SHELVES
SA	9	2 uds. por estante en estantería ANGULAR 2 units per shelf in the ANGULAR shelving units



Para su comodidad en las Tablas de Valoración y Composición de Conjuntos, al final de este apartado, tiene ya calculados los conjuntos para cada longitud.

Usted solo ha de elegir el fondo de estante deseado, la altura de la estantería y el número de niveles de estantes.

Una vez elegido tome nota del Código de Artículo y háganos llegar su pedido.

For your convenience the length of each unit has been calculated in the Measurement and Pricing tables at the end of this catalogue.

You only have to choose the shelf depth, the shelving unit height and the numbers of shelves you want.

Once you have chosen, note down the product code and send us your order.

Ejemplo para colocar estanterías en forma de 'L' en un recinto de dimensiones 4000 x 3000 mm.

Para el ejemplo tomamos como base una estantería de altura 1670 mm, fondo 400 mm y 4 niveles de estantes.

1. Para la pared de 4000 mm de nuestro recinto consultaremos en la Tabla de Valoración y Composición de Conjuntos la estantería lineal de longitud inmediatamente inferior a los 4000 mm.

Buscando en la tabla Estantería lineal de fondo 400 mm. altura 1670 mm y 4 niveles encontramos una estantería con longitud 3960 mm. (Cód. de artículo L214).

2. En la siguiente pared de 3000 mm. queremos colocar otra estantería. En este caso elegiremos una estantería angular.

La longitud de la misma será 3000 mm. que es la dimensión de la pared menos el fondo de la estantería que hemos colocado anteriormente. En nuestro ejemplo es 400 mm.

Buscaremos en la tabla Estantería angular de fondo 400 mm. y altura 1670 mm y 4 niveles y encontraremos una estantería de longitud 2580 mm. (Cód. de artículo A201).

Si quisieramos colocar otra estantería en la segunda pared de 4000 mm. solo tendríamos que repetir el paso 2.

Example of how to build an L shaped shelving unit in a 4000x3000mm room.

For this we would choose a shelving unit measuring 1670mm height, a 400mm depth and 4 shelves.

1. For a wall measuring 4000mm, we would consult the Measurement and Pricing tables for a shelving unit measuring less than 4000mm in length.

Searching in the table for a Linear Shelving Unit with a depth of 400mm, a height of 1670mm and 4 shelves, we find a shelving unit measuring 3960mm in length. (Product code L214).

2. On the other wall measuring 3000mm, we want to assemble another shelving unit.

In this case we choose an angular shelving unit.

The length of the unit will measure 3000mm, equalling the length of the wall, minus the depth of the other shelving unit we have already assembled. In our example it measures 400mm.

Searching in the table for a Angular Shelving Unit with a depth of 400mm, a height of 1670mm and 4 shelves, we find a shelving unit measuring 2580mm in length. (Product code A201).

If we wanted to put another shelving unit on the second wall measuring 4000mm, we would just repeat step 2.

BANCADAS:

Diseñadas para almacenar cajas en recintos frigoríficos y lugares donde se debe cumplir las normativas higiénicas. Fabricadas con los mismos materiales que el resto de las estantería. Gran capacidad de carga hasta 150 Kgrs. Altura de la base de la bancada al suelo 250 mm.

BENCHES:

Our benches are made from the same material as our shelving units, and are designed to store boxes in cold rooms and places where hygiene regulations must be complied with. The benches can store a load capacity of up to 150kg. The top of the bench measures 250mm from the ground.

FONDO 400 / DEPTH 400

MEDIDAS / DIMENSIONS	MODELO / MODEL	€
690x250x 400	B600F4	136 €
790x250x 400	B700F4	143 €
890x250x 400	B800F4	155 €
990x250x 400	B900F4	160 €
1090x250x 400	B1000F4	164 €
1190x250x 400	B1100F4	169 €
1290x250x 400	B1200F4	174 €
1390x250x 400	B1300F4	181 €
1490x250x 400	B1400F4	192 €
1590x250x 400	B1500F4	193 €
1690x250x 400	B1600F4	198 €

FONDO 500 / DEPTH 500

MEDIDAS / DIMENSIONS	MODELO / MODEL	€
690x250x 500	B600F5	146 €
790x250x 500	B700F5	152 €
890x250x 500	B800F5	164 €
990x250x 500	B900F5	171 €
1090x250x 500	B1000F5	176 €
1190x250x 500	B1100F5	181 €
1290x250x 500	B1200F5	184 €
1390x250x 500	B1300F5	189 €
1490x250x 500	B1400F5	204 €
1590x250x 500	B1500F5	204 €
1690x250x 500	B1600F5	207 €

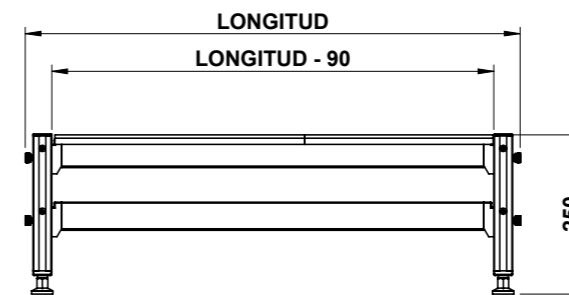

Recuerde:

Para elegir su estantería LINEAL vaya a las tablas de valoraciones de Estantería Lineal y elija la que mejor se adapte a la longitud de su recinto.

Para elegir su estantería ANGULAR vaya a las tablas de valoraciones de Estantería Angular y elija la que mejor se adapte a su recinto.

En este caso NO OLVIDE descontar a las dimensiones de su recinto el FONDO que haya elegido para su estantería lineal.

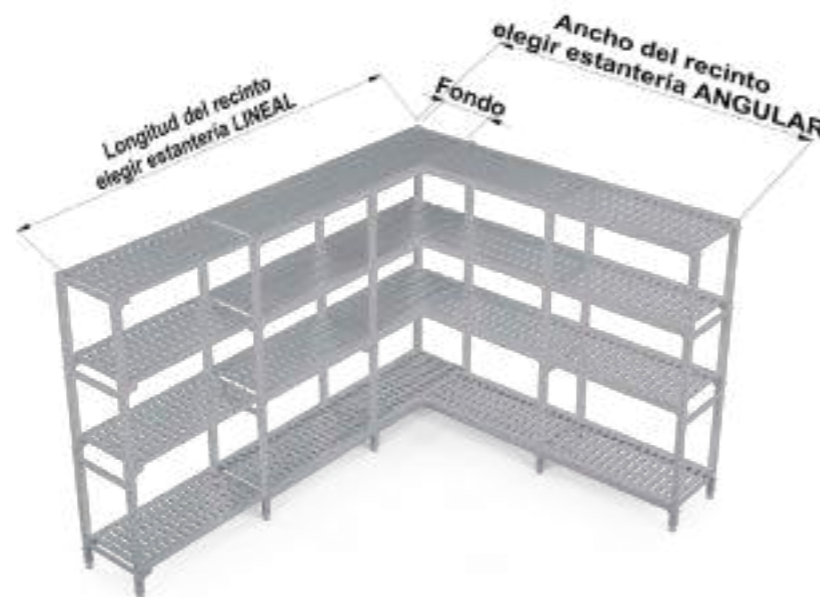

Remember:

To choose your LINEAR shelving unit check the measurement and pricing table for Linear Shelving Units and choose the one that best suits the length of your room.

To choose your ANGULAR shelving unit check the measurement and pricing table for Angular Shelving Units and choose the one that best suits your room.

DO NOT FORGET to subtract from the room measurements the DEPTH of the linear shelving unit you choose.

Escanea el código QR o acceda a www.docriluc.es para ver PVP

Scan the QR code or access www.docriluc.es to see PVP

Scannez le code QR ou accéder à www.docriluc.es pour voir PVP



R134a
R449A
R452A
R-290
[Otros refrigerantes, consultar](#)

R134a
R449A
R452A
R-290
[Otros refrigerantes, consultar](#)

intarblock



Equipos frigoríficos compactos de pared para cámaras frigoríficas de pequeño tamaño en aplicaciones a media y baja temperatura. Disponible en versión axial y con condensación centrífuga, con posibilidad de montaje acaballado o tampón directamente en la pared de la cámara frigorífica.

- * Fácil instalación directamente sobre la pared de la cámara
- * Versiones centrífugas que permiten la extracción del aire de condensación.
- * Disponible versión para intemperie.

intartop



Equipos frigoríficos compactos de techo para cámaras frigoríficas de pequeño tamaño en aplicaciones a media y baja temperatura. Disponible en versiones estándar y centrífuga, con montaje directo sobre el techo de la cámara frigorífica

- * Fácil instalación directamente sobre el techo de la cámara.
- * Versiones centrífugas que permiten la extracción del aire de condensación.

intarblock puerta



Equipos frigoríficos compactos de puerta para cámaras frigoríficas de pequeño tamaño en aplicaciones a media y baja temperatura.

- * Equipo compacto de carga reducida de refrigerante, menor a 1 kg.
- * Diseño tropicalizado para temperatura ambiente de 45 °C.
- * Cortina de aire (opcional).
- * Desescarche por gas caliente con control de temperatura.
- * Equipos exentos de control de fugas.
- * Fácil instalación sobre la puerta con cortina de aire integrada.



Equipos compuestos por una unidad condensadora en construcción horizontal, con ventilador axial o centrífugo, y una unidad evaporadora de bajo perfil o de tipo cúbico.

- * Diseño tropicalizado para temperatura ambiente de 45 °C.
- * Válvula de expansión termostática.
- * Versión con condensación centrífuga.

Sigilus

Equipos compuestos por una unidad condensadora silenciosa para su instalación en intemperie y una unidad evaporadora de bajo perfil o de tipo cúbico. Gracias a su triple tratamiento acústico las motocondensadoras Sigilus se encuentran entre los equipos más silenciosos de su clase, y gracias a su diseño tropicalizado, pueden funcionar bajo temperaturas extremas.

- * Diseño tropicalizado para temperatura ambiente de 50 °C.
- * Unidad condensadora silenciosa con ventiladores de baja velocidad.
- * Válvula de expansión termostática.

Escanea el código QR o acceda a www.docriluc.es para ver PVP

Scan the QR code or access www.docriluc.es to see PVP

Scannez le code QR ou accédez à www.docriluc.es pour voir PVP



intarblock R-290



Diseño

La nueva gama de equipos monoblock incorpora componentes de última tecnología en una construcción muy compacta que se integra en el panel de la cámara frigorífica.

Su diseño estilizado permite aprovechar al máximo el espacio de almacenamiento, y su estructura aligerada reduce al mínimo los puentes térmicos y las pérdidas de frío.

Alta eficiencia energética



Junto al excelente rendimiento termodinámico del refrigerante R-290, los equipos monoblock integran componentes de bajo consumo, como ventiladores electrónicos, iluminación led o compresores de alta eficiencia.



Sostenibilidad medioambiental

El R-290 o propano es un hidrocarburo utilizado habitualmente en refrigeración doméstica y pequeñas aplicaciones de refrigeración comercial. Gracias a su bajo impacto medioambiental y sus excelentes propiedades termodinámicas, el R-290 es la mejor opción en pequeñas cámaras frigoríficas.

Seguridad y fiabilidad



Los equipos monoblock de INTARCON cumplen con todos los requisitos de seguridad, poseen una ínfima carga de refrigerante R-290, y cuentan con componentes antideflagrantes, dispositivos de limitación de presión y temperatura.

- * Equipo compacto de carga reducida de R-290, menor a 200 g.
- * Diseño tropicalizado para temperatura ambiente de 45 °C.
- * Válvula de expansión termostática.
- * Desescarche por gas caliente con control de temperatura.

Propano

El propano o R-290, es un hidrocarburo utilizado como refrigerante en equipos compactos de refrigeración comercial. Tiene un bajo impacto medio ambiental y unas excelentes propiedades termodinámicas.

- Potencial de calentamiento atmosférico PCA (GWP) = 3
- Punto ebullición a 1,013 bar (°C): -42,10
- Deslizamiento de temperatura (°C): 0
- Clasificación seguridad: A3. No tóxico pero extremadamente inflamable.
- El Reglamento de Instalaciones Frigoríficas (RSIF) RD 552/2019 y el Comité Electrotécnico Internacional IEC 60335 admiten el uso de hasta 0,5 kg en equipos compactos de refrigeración comercial.

Controlador electrónico

La regulación electrónica XW60LH, de serie en nuestros equipos compactos comerciales de puerta, es un avanzado controlador de reducido tamaño, que incluye las siguientes funciones:



- Control de temperatura con registro de temperaturas máxima y mínima.
- Función "Jet Cool" de enfriamiento rápido.
- Modo de funcionamiento nocturno.
- 4 relés de salida para: compresor, ventilador, desescarche y luz.
- 3 sondas NTC de temperatura para termostato, desescarche y condensación.

Luz led de cámara integrada

Luz led de cámara de gran eficiencia, integrada en el equipo, que se activa automáticamente al abrirse la puerta de la cámara.

Ejemplo de instalación



Compactos de techo de propano

serie MCV / BCV

Descripción

Equipos ultra compactos monoblocks diseñados para minicámaras frigoríficas de refrigeración y congelación, para montaje en ventana sobre la pared de la cámara.

Características

- Alimentación 230 V-I-50 Hz. (Disponible en 60 Hz)
- Carga de refrigerante R-290 inferior a 200 g.
- Compresor hermético alternativo.
- Motoventiladores electrónicos EC.
- Presostato de alta.
- Expansión por válvula termostática.
- Desescarche por inyección de gas caliente.
- Bandeja de condensados en acero inoxidable.
- Evaporación automática de condensados.
- Luz led de cámara con microinterruptor de puerta.
- Tampón desmontable incluido.
- Cable de resistencia de puerta (solo modelos BCV).
- Regulación electrónica multifunción.

Esquema de instalación

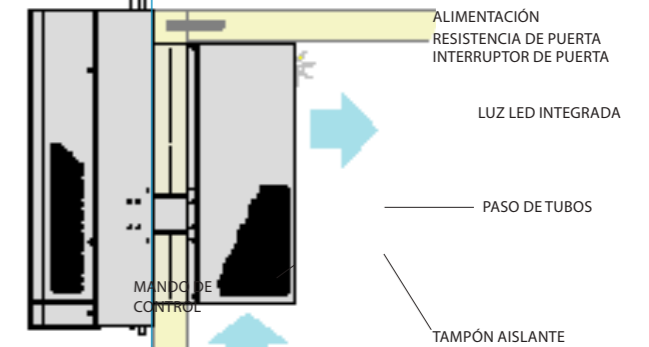

230 V-I-50 Hz | Media temperatura | R-290

Serie / Modelo	Compresor		Potencia frigorífica / Volumen cámara, según temperatura de cámara ⁽¹⁾						Potencia absorb. nominal (kW)	Intens. máxima absorb. (A)	Caudal evap. (m³/h)	Carga refrig. (kg)	Peso (kg)	Nivel presión sonora dB(A) ⁽²⁾	
	CV	Tensión	0 °C		5 °C		10 °C								
			W	m³	W	m³	W	m³							
R-290	MCV-LD-0 009	1/3	230 V-I	635	5	740	7	850	12	0,40	3,5	300	< 0,10	38	29
	MCV-LD-1 012	1/2	230 V-I	1 050	9	1 220	15	1 410	27	0,52	3,3	500	< 0,10	56	29
	MCV-LD-1 017	3/4	230 V-I	1 340	14	1 560	21	1 780	36	0,68	4,3	500	< 0,15	57	31
	MCV-LD-2 026	2	230 V-I	1 824	21	2 170	34	2 540	58	0,94	5,9	950	< 0,15	86	35
	MCV-LD-2 034	2 1/2	230 V-I	2 215	27	2 618	43	2 960	70	1,31	9,0	950	< 0,20	86	35

230 V-I-50 Hz | Baja temperatura | R-290

Serie / Modelo	Compresor		Potencia frigorífica / Volumen cámara, según temperatura de cámara ⁽¹⁾						Potencia absorb. nominal (kW)	Intens. máxima absorb. (A)	Caudal evap. (m³/h)	Carga refrig. (kg)	Peso (kg)	Nivel presión sonora dB(A) ⁽²⁾	
	CV	Tensión	-25 °C		-20 °C		-15 °C								
			W	m³	W	m³	W	m³							
R-290	BCV-LD-0 014	3/4	230 V-I	370	1	440	2	520	4	0,38	3,6	300	< 0,10	38	29
	BCV-LD-1 017	3/4	230 V-I	540	2	660	5	790	8	0,48	4,3	500	< 0,10	57	29
	BCV-LD-1 028	1 1/4	230 V-I	770	4	920	9	1 090	15	0,73	5,6	500	< 0,15	64	31
	BCV-LD-2 034	1 1/2	230 V-I	985	7	1 210	14	1 470	25	0,97	9,3	950	< 0,20	86	34

Opcionales

- Tratamiento anticorrosión en epoxi de la batería de evaporación.

+ 6 %

Dimensiones

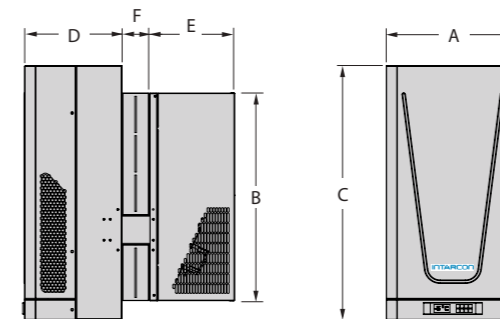

Dimensiones (mm)	A	B	C	D	E	F
serie 0	420	596	803	237	207	86
serie 1	420	656	803	307	270	86
serie 2	620	676	764	343	310	106

⁽¹⁾ Las prestaciones nominales están referidas al funcionamiento con temperaturas de cámara de 0 °C (MT) o -20 °C (BT), y temperatura exterior de 35 °C. Volumen de cámara recomendado para cámaras con suelo y aislamiento de 80 mm en MT o 100 mm en BT, densidad de mercancía de 250 kg/m³ con una rotación diaria del 10 % a una temperatura de entrada de 25 °C en MT y -15 °C en BT.

⁽²⁾ Nivel sonoro máximo referido a nivel de presión acústica en dB(A), medido en campo abierto a 10 m de distancia de la fuente.

Marcos de montaje

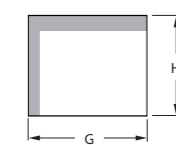

CALADO TAMPÓN

Dimensiones (mm)	G	H
serie 0	400	600
serie 1	400	660
serie 2	600	680



- ❖ Equipo compacto de carga reducida de refrigerante, menor a 2 kg.
- ❖ Diseño tropicalizado para temperatura ambiente de 45 °C.
- ❖ Válvula de expansión termostática.
- ❖ Desescarche por gas caliente con control de temperatura.
- ❖ Equipos exentos de control de fugas.

Descripción Equipos compactos monoblock para montaje sobre pared en cámaras frigoríficas de pequeño tamaño de refrigeración y congelación.

- Características**
- Alimentación 230 V-I-50 Hz o 400 V-III-50 Hz.
 - Carga de refrigerante R-134a o R-449A, inferior a 2 kg.
 - Compresor hermético alternativo.
 - Presostatos de alta presión.
 - Expansión por válvula termostática.
 - Protección magnetotérmica.
 - Desescarche por inyección de gas caliente.
 - Bandeja de condensados en acero inoxidable.
 - Evaporación automática de condensados.
 - Luz de cámara y cable de interruptor de puerta.
 - Cable de resistencia de puerta (solo modelos BCV).
 - Tampón desmontable incluido.
 - Regulación electrónica multifunción.

Serie CV-N Equipos compactos preparados para montaje en ventana y equipados con tampón aislante desmontable para montaje acaballado.

Serie CV-C Versión centrífuga con condensador equipado con turbina centrífuga para la conducción al exterior del aire caliente de condensación.

Serie CV-I Equipos compactos aptos para intemperie para instalación en exterior en pequeñas cámaras frigoríficas a temperatura positiva o negativa.

Esquemas de instalación

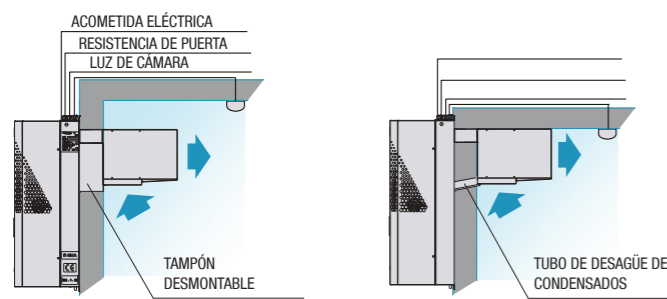

Montaje tampón
Se suministra de serie un tampón desmontable para montaje directo sobre ventana en la cámara frigorífica.

Montaje acaballado (excepto serie 0)
Es posible realizar un montaje acaballado de forma sencilla, simplemente preparando un marco para su instalación y posteriormente colocando el techo de la cámara.

Controlador electrónico

Los equipos intarblock incorporan de serie el avanzado controlador electrónico XWING.



- Control de temperatura con registro de temperaturas máxima y mínima.
- Función "Jet Cool" de enfriamiento rápido.
- Modo de funcionamiento nocturno.

Versión centrífuga

Los equipos de la serie intarblock centrífuga incorporan una turbina centrífuga para permitir la conducción hacia el exterior del aire caliente de descarga mediante conductos.

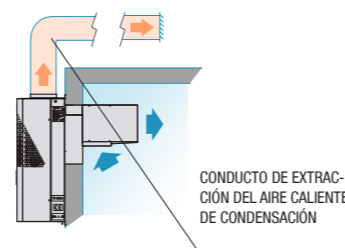

Conductos de extracción de aire

Dimensiones recomendadas para conductos de descarga en chapa, PVC, o panel de lana de vidrio, de 20 m de longitud (cada codo a 90° equivale a 5 m de longitud). Para conductos flexibles o semirrígidos se recomienda utilizar una dimensión mayor.

- serie 0: 200 x 150 mm. ó Ø 150
- serie 1: 200 x 200 mm. ó Ø 150
- serie 2: 200 x 250 mm. ó Ø 200
- serie 3: 300 x 200 mm. ó Ø 250

230 V-I-50 Hz* / 400 V-III-50 Hz | Media temperatura | R134a

SERIE / MODELO AXIALES	COMPRESOR		POTENCIA FRIGORÍFICA / VOLUMEN CÁMARA, SEGÚN TEMPERATURA DE CÁMARA (1)						POTENCIA ABSORBE. NOMINAL (kW)	INTENS. MÁXIMA ABSORBE. (A)	CAUDAL. EVAP. (m³/h)	CARGA REFRIG. (kg)	PESO (kg)	NIVEL PRESIÓN SONORA dB(A) (2)
	CV	TENSIÓN	0°C		5°C		10°C							
			W	m³	W	m³	W	m³						
MCV-NY-0 010	3/8	230 V-I	610	4,0	758	7,0	907	12	0,43	4,5	300	<1,0	36	29
MCV-NY-0 015	1/2	230 V-I	794	6,0	961	10	1139	18	0,53	5,5	300	<1,0	38	32
MCV-NY-1 015	1/2	230 V-I	972	8	1199	14	1453	23	0,57	5,6	500	<1,0	60	32
MCV-NY-1 026	3/4	230 V-I	1281	12	1565	19	1859	30	0,81	9,3	500	<1,0	69	30
MCV-NY-1 033	1	230 V-I	1454	14	1743	25	2037	41	0,92	9,5	500	<1,0	70	33
MCV-NY-2 033	1	230 V-I	1790	19	2163	36	2573	57	1,09	10,3	950	<1,5	88	34
MCV-NY-2 053	1 1/2	230 V-I *	2153	24	2609	41	3103	72	1,46	12,9	950	<1,5	89	38
MCV-NY-3 053	1 1/2	230 V-I *	2489	29	3103	53	3743	83	1,51	13,1	1300	<2,0	117	39
MCV-NY-3 074	2	230 V-I *	3239	40	3938	70	4667	97	1,89	17,1	1300	<2,0	114	44
MCV-NY-3 108	5	400 V-III	3927	51	4725	110	5539	130	2,48	18,6	1300	<2,0	116	45

230 V-I-50 Hz* / 400 V-III-50 Hz | Baja temperatura | R449A

SERIE / MODELO AXIALES	COMPRESOR		POTENCIA FRIGORÍFICA / VOLUMEN CÁMARA, SEGÚN TEMPERATURA DE CÁMARA (1)						POTENCIA ABSORBE. NOMINAL (kW)	INTENS. MÁXIMA ABSORBE. (A)	CAUDAL. EVAP. (m³/h)	CARGA REFRIG. (kg)	PESO (kg)	NIVEL PRESIÓN SONORA dB(A) (2)
	CV	TENSIÓN	-25°C		-20°C		-15°C							
			W	m³	W	m³	W	m³						
BCV-NG-0 018	5/8	230 V-I	382	0,6	486	1,5	596	2,8	0,50	4,7	300	<0,5	38	31
BCV-NG-1 026	3/4	230 V-I	550	2,1	721	4,3	888	7,6	0,84	8,5	550	<1,0	60	31
BCV-NG-1 034	1 1/4	230 V-I	697	3,2	882	6,1	1047	10	1,05	11,0	550	<1,0	60	33
BCV-NG-2 034	1 1/4	230 V-I	793	3,8	1049	7,7	1341	14	1,11	11,9	950	<1,0	89	35
BCV-NG-2 055	1 3/4	230 V-I *	1155	8	1560	15	1960	26	1,6	17,5	950	<1,0	96	41
BCV-NG-2 075	2 1/2	230 V-I *	1453	11	1835	18	2245	31	2,0	25,5	950	<1,0	101	44
BCV-NG-3 075	2 1/2	230 V-I *	1680	13	2150	23	2635	38	2,2	12,3	1300	<1,5	113	44
BCV-NG-3 096	3 1/2	400 V-III	2022	18	2492	32	2942	54	2,39	12,1	1300	<1,5	129	49

Opcionales

- Cambio a alimentación 400 V-III-50 Hz.
- Microinterruptor de puerta.
- Compuerta antirretorno (equipos centrífugos).
- Adaptación de impulsión de aire a conducto circular.
- Tratamiento anticorrosión en epoxi de la batería de evaporación.
- Otros refrigerantes.

Consultar

Dimensiones

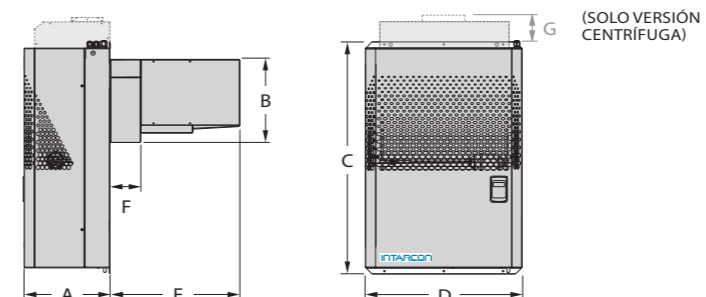

Dimensiones (mm)	A	B	C	D	E	F	Embocadura turbina
serie 0	306	510	683	420	250	50	185 x 115
serie 1	340	330	880	400	514	122	185 x 115
serie 2	340	330	920	620	514	122	230 x 130
serie 3	365	470	940	735	514	122	2x 185 x 115

(1) Las prestaciones nominales están referidas al funcionamiento con temperatura de cámara de 0°C (MT) y -20°C (BT), y temperatura exterior de 35°C. Volumen de cámara estimado según condiciones de las bases de cálculo (pág. VI).

(2) Presión sonora en dB(A) en campo abierto a 10 m de la fuente.

(3) Presión estática disponible en conductos de expulsión.

* Unidades disponibles en tensión 400 V-III-50 Hz.

Marcos de montaje

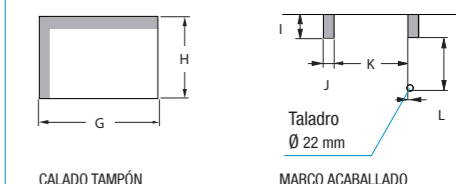

Dimensiones	G	H	I	J	K	L	M
serie 0	405	515			n/a		
serie 1	380	335	75	41	295	13	233
serie 2	600	335	75	36	523	13	233
serie 3	710	475	75	41	611	22	356

Intartop R-290

Compactos de techo de propano

serie MCR / BCR



Descripción

Equipos compactos monoblock para cámaras frigoríficas de pequeño tamaño de refrigeración y congelación, para montaje en techo.

Características

- Alimentación 230 V-I-50 Hz. Disponible en 60 Hz. (Otras tensiones consultar)
- Carga de refrigerante R-290, inferior a 0,2 kg.
- Compresor hermético alternativo.
- Presostatos de alta.
- Expansión por válvula termostática.
- Protección magnetotérmica.
- Desescarche por inyección de gas caliente.
- Bandeja de condensados en acero inoxidable.
- Evaporación automática de condensados.
- Luz led de cámara con microinterruptor de puerta.
- Cable de resistencia de puerta (solo modelos BCR).
- Cajón de evaporación en panel sándwich de 50 mm de espuma de poliuretano, revestido interiormente con chapa de acero prelacado.
- Regulación electrónica multifunción.

Esquema de instalación

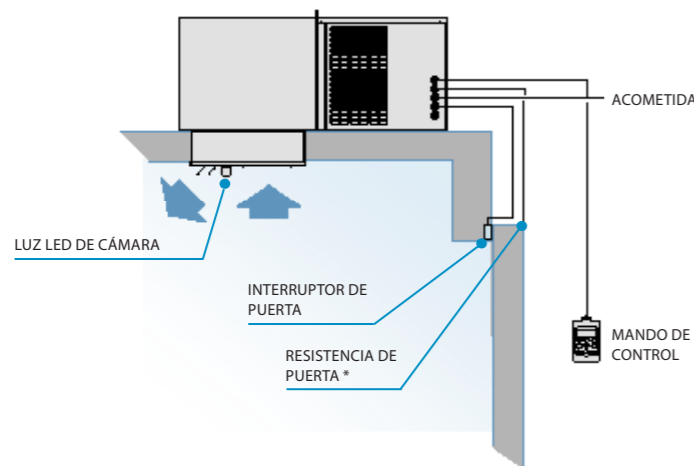

* Resistencia de puerta solo en modelos de baja temperatura.

- * Carga reducida de refrigerante menor a 200 g.
- * Diseño tropicalizado para temperatura ambiente de 45 °C.
- * Válvula de expansión termostática.
- * Desescarche por gas caliente con control de temperatura.

Propano

El propano o R-290, es un hidrocarburo utilizado como refrigerante en equipos compactos de refrigeración comercial. Tiene un bajo impacto medio ambiental y unas excelentes propiedades termodinámicas.

- Potencial de calentamiento atmosférico PCA (GWP) = 3
- Punto ebullición a 1,013 bar (°C): -42,10
- Deslizamiento de temperatura (°C): 0
- Clasificación seguridad: A3. No tóxico pero extremadamente inflamable.
- El Reglamento de Instalaciones Frigoríficas (RSIF) RD 552/2019 y el Comité Electrotécnico Internacional IEC 60335 admiten el uso de hasta 0,5 kg en equipos compactos de refrigeración comercial.

Controlador electrónico

Los equipos intartop incorporan de serie el avanzado controlador electrónico XWING:



- Mando multifunción de control digital a distancia.
- Control de temperatura con registro de temperaturas máxima y mínima.
- Función "Jet Cool" de enfriamiento rápido.
- Modo de funcionamiento nocturno.

Luz led de cámara integrada

Luz led de cámara de gran eficiencia, integrada en el equipo, que se activa automáticamente al abrirse la puerta de la cámara.

Ejemplo de instalación



230 V-I-50 Hz | Media temperatura | R-290

Serie / Modelo	Compresor		Potencia frigorífica / Volumen cámara, según temperatura de cámara ⁽¹⁾						Potencia absorb. nominal (kW)	Intens. máxima absorb. (A)	Caudal evap. (m³/h)	Carga refrig. (kg)	Peso (kg)	Nivel presión sonora dB(A) ⁽²⁾
	CV	Tensión	0 °C		5 °C		10 °C							
			W	m³	W	m³	W	m³						
MCR-ND-0 009	1/3	230 V-I	670	5	780	7	900	12	0,39	3,6	300	< 0,10	63	29
MCR-ND-1 012	1/2	230 V-I	1 060	9	1 240	15	1 435	27	0,53	3,4	600	< 0,10	73	29
MCR-ND-1 017	3/4	230 V-I	1 370	14	1 585	21	1 815	36	0,68	4,5	600	< 0,15	73	31
MCR-ND-2 026	2	230 V-I	1 850	21	2 200	34	2 577	58	0,98	5,9	1 150	< 0,15	96	35
MCR-ND-2 034	2 1/2	230 V-I	2 240	27	2 650	43	2 995	70	1,35	9,0	1 150	< 0,20	96	35

230 V-I-50 Hz | Baja temperatura | R-290

Serie / Modelo	Compresor		Potencia frigorífica / Volumen cámara, según temperatura de cámara ⁽¹⁾						Potencia absorb. nominal (kW)	Intens. máxima absorb. (A)	Caudal evap. (m³/h)	Carga refrig. (kg)	Peso (kg)	Nivel presión sonora dB(A) ⁽²⁾
	CV	Tensión	-25 °C		-20 °C		-15 °C							
			W	m³	W	m³	W	m³						
BCR-ND-0 014	3/4	230 V-I	385	1	460	2	550	4	0,39	3,3	300	< 0,10	65	29
BCR-ND-1 017	3/4	230 V-I	540	2	660	5	800	8	0,49	3,5	600	< 0,10	73	29
BCR-ND-1 028	1 1/4	230 V-I	770	4	925	9	1 100	15	0,73	6,0	600	< 0,15	80	31
BCR-ND-2 034	1 1/2	230 V-I	985	7	1 215	14	1 475	25	0,99	9,3	1 150	< 0,20	96	34

Opcionales

- Tratamiento anticorrosión en epoxi de la batería de evaporación. + 6 %

Dimensiones

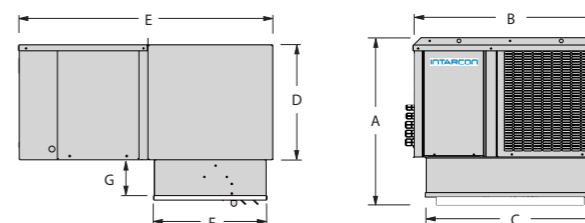

Dimensiones (mm)	A	B	C	D	E	F	G
serie 0	480	600	430	330	790	375	100
serie 1	580	660	585	385	850	380	135
serie 2	665	830	755	470	850	380	135

⁽¹⁾ Las prestaciones nominales están referidas al funcionamiento con temperaturas de cámara de 0 °C (MT) o -20 °C (BT), y temperatura exterior de 35 °C. Volumen de cámara recomendado para cámaras con suelo y aislamiento de 80 mm en MT o 100 mm en BT, densidad de mercancía de 250 kg/m³ con una rotación diaria del 10 % a una temperatura de entrada de 25 °C en MT y -15 °C en BT.

⁽²⁾ Nivel sonoro máximo referido a nivel de presión acústica en dB(A), medido en campo abierto a 10 m de distancia de la fuente.

Marcos de montaje

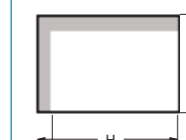

CALADO EN TECHO

Dimensiones (mm)	H	I
serie 0	435	380
serie 1	590	385
serie 2	760	385





- ❖ Equipo compacto de carga reducida de refrigerante, menor a 1,5 kg.
- ❖ Diseño tropicalizado para temperatura ambiente de 45 °C.
- ❖ Válvula de expansión termostática.
- ❖ Desescarche por gas caliente con control de temperatura.
- ❖ Equipos exentos de control de fugas.

Descripción Equipos compactos monoblock para cámaras frigoríficas de pequeño tamaño de refrigeración y congelación, para montaje en techo.

- Características**
- Alimentación 230 V-I-50 Hz o 400 V-III-50 Hz. Disponible en 60 Hz
 - Carga de refrigerante R-134a o R-449A, inferior a 1,5 kg.
 - Compresor hermético alternativo.
 - Presostatos de alta presión.
 - Expansión por válvula termostática.
 - Protección magnetotérmica.
 - Desescarche por inyección de gas caliente.
 - Bandeja de condensados en acero inoxidable.
 - Evaporación automática de condensados.
 - Cable de resistencia de puerta (solo modelos BCR).
 - Cajón de evaporación en panel sándwich de 50 mm de espuma de poliuretano, revestido interiormente con chapa de acero prelacado.
 - Regulación electrónica multifunción.

Serie CR-N Equipos monoblock preparados para montaje en techo.

Serie CR-C Versión centrífuga con condensador equipado con turbina centrífuga para la conducción al exterior del aire caliente de condensación.

Esquema de instalación

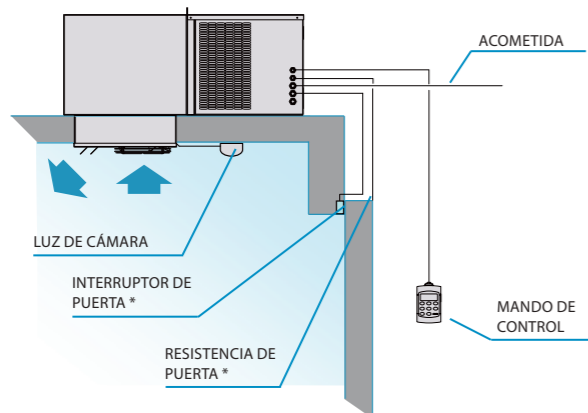

* Resistencia de puerta sólo en modelos de baja temperatura.
* Interruptor de puerta no suministrado.

Controlador electrónico

Los equipos intartop incorporan de serie el avanzado controlador electrónico XWING.



- Mando multifunción de control digital a distancia.
- Control de temperatura con registro de temperaturas máxima y mínima.
- Función "Jet Cool" de enfriamiento rápido.
- Modo de funcionamiento nocturno.

Versión centrífuga

Los equipos de la serie intartop centrífuga incorporan una turbina centrífuga para permitir la conducción hacia el exterior del aire caliente de descarga mediante conductos.



230 V-I-50 Hz* | Media temperatura | R134a

SERIE / MODELO AXIALES	COMPRESOR		POTENCIA FRIGORÍFICA / VOLUMEN CÁMARA SEGÚN TEMPERATURA DE CÁMARA ⁽¹⁾						POTENCIA ABSORB. NOMINAL (kW)	INTENS. MÁXIMA ABSORB. (A)	CAUDAL EVAP. (m³/h)	CARGA REFRIG. (kg)	PESO (kg)	NIVEL PRESIÓN SONORA dB(A) ⁽²⁾
	CV	TENSIÓN	0°C		5°C		10°C							
			W	m³	W	m³	W	m³						
MCR-NY-0 010	3/8	230 V-I	605	4,0	751	7,0	902	12	0,43	4,5	300	<1,0	62	29
MCR-NY-0 015	1/2	230 V-I	788	6,1	956	10	1 134	18	0,53	5,5	300	<1,0	65	32
MCR-NY-1 015	1/2	230 V-I	999	8,2	1 231	12	1 490	23	0,58	5,6	600	<1,0	73	32
MCR-NY-1 026	3/4	230 V-I	1 265	12	1 549	19	1 853	30	0,93	9,3	600	<1,0	82	30
MCR-NY-1 033	1	230 V-I	1 502	16	1 817	26	2 153	41	1,05	9,5	600	<1,0	83	33
MCR-NY-2 033	1	230 V-I	1 911	24	2 363	37	2 846	61	1,21	10,3	1 150	<1,5	98	34
MCR-NY-2 053	1 1/2	230 V-I*	2 352	33	2 882	50	3 455	75	1,67	12,9	1 150	<1,5	99	38
MCR-NY-2 074	2	230 V-I*	2 940	40	3 560	60	4 211	90	1,83	16,9	1 150	<1,5	110	44
MCR-NY-3 108	5	400 V-III*	2 940	48	4 465	71	5 155	121	2,30	15,1	1 300	<2,0	149	45

VERSION CENTRIFUGA		
SERIE / MODELO CENTRIFUGOS	CAUDAL COND. (m³/h)	P.E.D. ⁽³⁾ (mmca)
MCR-CY-0 010	375	8
MCR-CY-0 015	375	8
MCR-CY-1 015	575	8
MCR-CY-1 026	575	8
MCR-CY-1 033	575	8
MCR-CY-2 033	1 000	12
MCR-CY-2 053	1 000	12
MCR-CY-2 074	1 000	12
MCR-CY-3 108	1 500	14

230 V-I-50 Hz* | Baja temperatura | R449A

SERIE / MODELO AXIALES	COMPRESOR		POTENCIA FRIGORÍFICA / VOLUMEN CÁMARA SEGÚN TEMPERATURA DE CÁMARA ⁽¹⁾						POTENCIA ABSORB. NOMINAL (kW)	INTENS. MÁXIMA ABSORB. (A)	CAUDAL EVAP. (m³/h)	CARGA REFRIG. (kg)	PESO (kg)	NIVEL PRESIÓN SONORA dB(A) ⁽²⁾
	CV	TENSIÓN	-25°C		-20°C		-15°C							
			W	m³	W	m³	W	m³						
BCR-NG-0 018	5/8	230 V-I	418	0,6	525	1,5	638	2,8	0,59	4,7	300	<0,5	65	31
BCR-NG-1 026	3/4	230 V-I	562	2,0	736	4,1	907	7,7	0,84	8,5	600	<1,0	84	31
BCR-NG-1 034	1 1/4	230 V-I	703	3,2	892	5,8	1 060	10	1,05	11,0	600	<1,0	84	33
BCR-NG-2 034	1 1/4	230 V-I	775	3,8	1 102	7,8	1 406	14	1,11	11,5	1 150	<1,0	135	35
BCR-NG-2 055	1 3/4	230 V-I*	1 160	8	1 575	15	2 015	27	1,6	12,6	1 150	<1,5	145	41
BCR-NG-3 096	3,5	400 V-I*	1 850	15	2 420	27	3 010	46	2,2	11,2	1 300	<1,5	147	49

VERSION CENTRIFUGA		
SERIE / MODELO CENTRIFUGOS	CAUDAL COND. (m³/h)	P.E.D. ⁽³⁾ (mmca)
BCR-CG-0 018	375	8
BCR-CG-1 026	575	8
BCR-CG-1 034	575	8
BCR-CG-2 034	1 000	12
BCR-CG-2 055	1 000	12
BCR-CG-3 096	1 500	14

- Opcionales**
- Cambio a alimentación 400 V-III-50 Hz.
 - Microinterruptor de puerta.
 - Compuerta antirretorno (equipos centrífugos).
 - Adaptación de impulsión de aire a conducto circular.
 - Impulsión vertical (equipos centrífugos).
 - Tratamiento anticorrosión en epoxi de la batería de evaporación.
 - Otros refrigerantes.

Consultar

Dimensiones

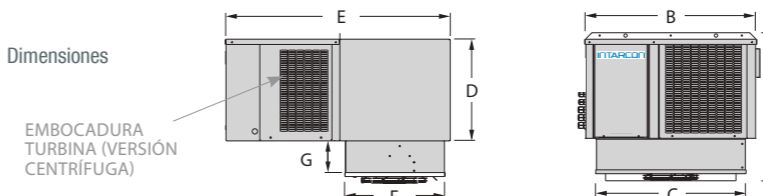

⁽¹⁾ Las prestaciones nominales están referidas al funcionamiento con temperatura de cámara de 0 °C (MT) y -20 °C (BT), y temperatura exterior de 35 °C. Volumen de cámara estimado según condiciones de las bases de cálculo (pág. 8).

⁽²⁾ Equipos con carga inferior a 5 toneladas de CO₂ equivalente (3,8 kg de R-134a o R-449A) exentos de comprobación de fugas (RD 552/2019).

⁽³⁾ Nivel sonoro referido a nivel de presión acústica en dB(A), medido en campo abierto a 10 m de distancia de la fuente.

⁽⁴⁾ Presión estática disponible de condensación.

* Unidades disponibles en tensión 400 V-III-50 Hz.

Marcos de montaje

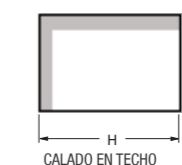

Dimensiones (mm)	H	I
serie 0	435	380
serie 1	590	385
serie 2	760	385
serie 3	850	460

Conductos de extracción de aire

Dimensiones recomendadas para conductos de descarga en chapa, PVC, o panel de lana de vidrio, de 20 m de longitud (cada codo a 90° equivale a 5 m de longitud). Para conductos flexibles o semirígidos se recomienda utilizar una dimensión mayor.

- serie 0: 200 x 150 mm o Ø 150 mm
- serie 1: 200 x 200 mm o Ø 150 mm
- serie 2: 250 x 150 mm o Ø 200 mm
- serie 3: 200 x 300 mm o Ø 250 mm

intarblock de puerta R-290

Compacto de puerta con cortina de aire

serie MCP / BCP



- ❖ Refrigerante natural R-290 de alta eficiencia energética.
- ❖ Óptimo aprovechamiento del espacio en minicámaras.
- ❖ Diseño tropicalizado para temperatura ambiente de 45 °C.
- ❖ Cortina de aire (opcional).
- ❖ Equipos exentos de control de fugas.

Cortina de aire (opcional)

Los equipos de puerta pueden incorporar de manera opcional una cortina de aire integrada en la propia unidad, especialmente dimensionada para puertas de 1800 mm de alto y hasta 800 mm de luz. Cuenta con un ventilador centrífugo de velocidad regulable, interruptor de puerta y difusor lineal.

La cortina de aire crea una barrera invisible para evitar las pérdidas de frío del interior de la cámara, que se activa durante la apertura de la puerta, y evita la entrada de aire caliente y la pérdida de aire frío, con una eficiencia superior al 50 %.

- Ventilador centrífugo.
- Difusor de aire longitudinal.
- Activación automática con apertura de puerta.

Controlador electrónico

La regulación electrónica XW60LH, de serie en nuestros equipos compactos comerciales de puerta, es un avanzado controlador de reducido tamaño, que incluye las siguientes funciones:



- Control de temperatura con registro de temperaturas máxima y mínima.
- Función Jet Cool de enfriamiento rápido.
- Modo de funcionamiento nocturno.
- Función Energy Saving.
- 4 relés de salida para: compresor, ventilador, desescarche y luz.
- 3 sondas NTC de temperatura para cámara, desescarche y condensación.

Luz led de cámara integrada

Luz led de cámara de gran eficiencia, integrada en el equipo, que se activa automáticamente al abrirse la puerta de la cámara.

Ejemplo de instalación



Descripción

Equipos compactos monoblock para minicámaras frigoríficas de refrigeración y congelación, para montaje sobre el panel de puerta de la cámara con opcional de refrigerante R-290 y cortina de aire integrada en el equipo.

Características

- Carga de refrigerante R290 inferior a 0,15 kg.
- Compresor hermético alternativo.
- Motoventiladores electrónicos EC
- Presostato de alta presión.
- Expansión por válvula termostática.
- Protección magnetotérmica.
- Desescarche por inyección de gas caliente.
- Bandeja de condensados en acero inoxidable.
- Evaporación automática de condensados.
- Luz led de cámara con microinterruptor de puerta.
- Tampón aislante desmontable
- Cable de resistencia de puerta (solo modelos BCP).
- Regulación electrónica multifunción.

Esquema de

instalación con cortina de aire (opcional)

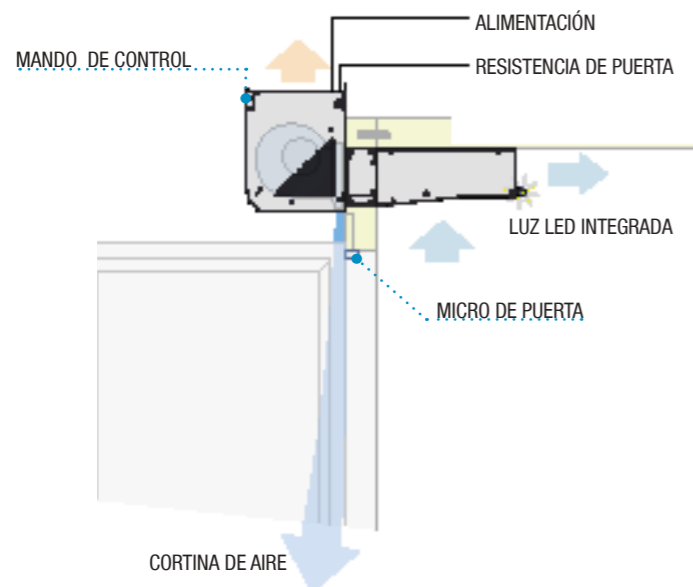

230 V-I-50 Hz | Media temperatura | R-290

Serie / Modelo	Compresor		Potencia frigorífica / Volumen cámara, según temperatura de cámara ⁽¹⁾						Potencia absorb. nominal (kW)	Intens. máxima absorb. (A)	Caudal evap. (m³/h)	Carga refrig. (kg) ⁽²⁾	Peso (kg)	Nivel presión sonora dB(A) ⁽³⁾
	CV	Tensión	0 °C		5 °C		10 °C							
			W	m³	W	m³	W	m³						
MCP-ND-0 009	1/3	230 V-I	700	6	810	8	945	13	0,34	3,1	275	< 0,1	61	29
MCP-ND-1 012	1/2	230 V-I	1 065	9	1235	15	1 430	27	0,52	4,3	550	< 0,1	67	29
MCP-ND-1 017	3/4	230 V-I	1 325	14	1 530	20	1 765	35	0,72	4,5	550	< 0,1	67	31

230 V-I-50 Hz | Baja temperatura | R-290

Serie / Modelo	Compresor		Potencia frigorífica / Volumen cámara, según temperatura de cámara ⁽¹⁾						Potencia absorb. nominal (kW)	Intens. máxima absorb. (A)	Caudal evap. (m³/h)	Carga refrig. (kg) ⁽²⁾	Peso (kg)	Nivel presión sonora dB(A) ⁽³⁾
	CV	Tensión	-25 °C		-20 °C		-15 °C							
			W	m³	W	m³	W	m³						
BCP-ND-0 014	3/4	230 V-I	420	1	500	2,5	590	5	0,30	3,3	275	< 0,1	62	29
BCP-ND-1 017	3/4	230 V-I	575	2	695	6	825	9	0,34	4,3	550	< 0,1	67	29
BCP-ND-1 058	1 1/4	230 V-I	750	4	905	9	1 070	15	0,64	6,0	550	< 0,1	74	31

Opcionales

- Tratamiento anticorrosión en epoxi de la batería de evaporación.

Dimensiones

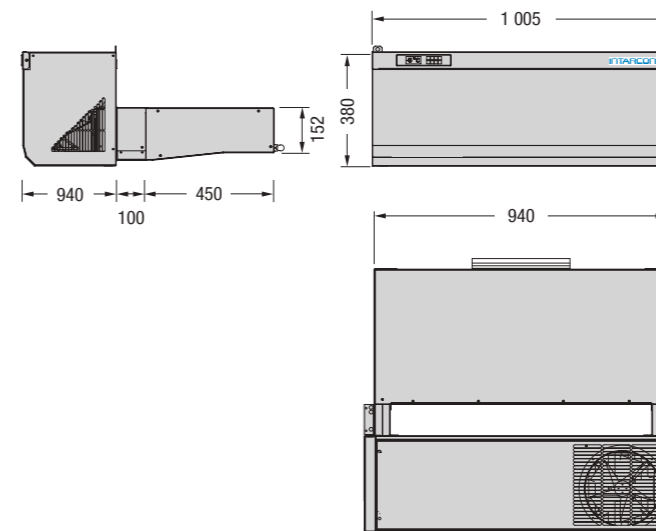

Dimensiones (mm)	A	B	C	D	E	F	G
serie 0	1 005	152	380	315	450	100	940
serie 1	1 005	152	380	315	450	100	940

⁽¹⁾ Las prestaciones nominales están referidas al funcionamiento con temperaturas de cámara de 0 °C (MT) o -20 °C (BT), y temperatura exterior de 35 °C. Volumen de cámara recomendado para cámaras con suelo y aislamiento de 80 mm en MT o 100 mm en BT, densidad de mercancía de 250 kg/m³ con una rotación diaria del 10 % a una temperatura de entrada de 25 °C en MT y -15 °C en BT.

⁽²⁾ Equipos con carga inferior a 5 toneladas de CO₂ equivalente (3,8 kg de R-134a o R-449A) exentos de comprobación de fugas (RD 552/2019).

⁽³⁾ Nivel sonoro máximo referido a nivel de presión acústica en dB(A), medido en campo abierto a 10 m de distancia de la fuente.

Marcos de montaje



Dimensiones (mm)	H	I	J
serie 0	185	828	58
serie 1	185	828	58

intarblock de puerta

Compacto de puerta con cortina de aire

serie MCP / BCP



Descripción

Equipos compactos monoblock para minicámaras frigoríficas de refrigeración y congelación, para montaje acaballado sobre el panel de puerta de la cámara con opcional de cortina de aire integrada en el equipo.

Características

- Alimentación 230 V-I-50 Hz. Disponible en 60 Hz (Otras tensiones consultar)
- Carga de refrigerante R-134a o R-449A, inferior a 1 kg.
- Compresor hermético alternativo.
- Presostatos de alta presión.
- Expansión por válvula termostática.
- Protección magnetotérmica.
- Desescarche por inyección de gas caliente.
- Bandeja de condensados en acero inoxidable.
- Evaporación automática de condensados.
- Luz led de cámara con microinterruptor de puerta.
- Cable de resistencia de puerta (solo modelos BCP).
- Regulación electrónica multifunción.

Esquema de

instalación con cortina de aire (opcional)

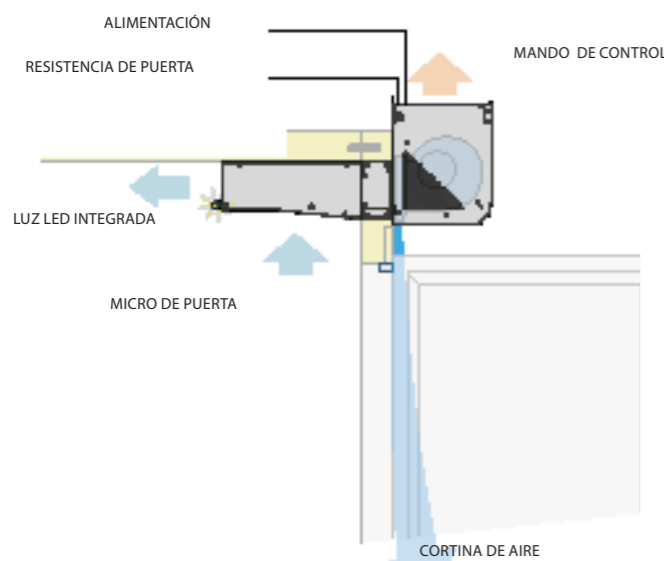

- ✳ Equipo compacto de carga reducida de refrigerante, menor a 1 kg.
- ✳ Diseño tropicalizado para temperatura ambiente de 45 °C.
- ✳ Cortina de aire (opcional).
- ✳ Desescarche por gas caliente con control de temperatura.
- ✳ Equipos exentos de control de fugas.

Cortina de aire (opcional)

Los equipos de puerta pueden incorporar de manera opcional una cortina de aire integrada en la propia unidad, especialmente dimensionada para puertas de 1800 mm de alto y hasta 800 mm de luz. Cuenta con un ventilador centrífugo de velocidad regulable, interruptor de puerta y difusor lineal.

La cortina de aire crea una barrera invisible para evitar las pérdidas de frío del interior de la cámara, que se activa durante la apertura de la puerta, y evita la entrada de aire caliente y la pérdida de aire frío, con una eficiencia superior al 50 %.

- Ventilador centrífugo.
- Difusor de aire longitudinal.
- Activación automática con apertura de puerta.

Controlador electrónico

La regulación electrónica XW60LH, de serie en nuestros equipos compactos comerciales de puerta, es un avanzado controlador de reducido tamaño, que incluye las siguientes funciones:



- Control de temperatura con registro de temperaturas máxima y mínima.
- Función "Jet Cool" de enfriamiento rápido.
- Modo de funcionamiento nocturno.
- 4 relés de salida para: compresor, ventilador, desescarche y luz.
- 3 sondas NTC de temperatura para cámara, desescarche y condensación.

Luz led de cámara integrada

Luz led de cámara de gran eficiencia, integrada en el equipo, que se activa automáticamente al abrirse la puerta de la cámara.

Ejemplo de instalación



230 V-I-50 Hz | Media temperatura | R-134a

Serie / Modelo	Compresor		Potencia frigorífica / Volumen cámara, según temperatura de cámara ⁽¹⁾						Potencia absorb. nominal (kW)	Intens. máxima absorb. (A)	Caudal evap. (m³/h)	Carga refrig. (kg) ⁽²⁾	Peso (kg)	Nivel presión sonora dB(A) ⁽³⁾
	CV	Tensión	0 °C		5 °C		10 °C							
			W	m³	W	m³	W	m³						
MCP-NY-0 010	3/8	230 V-I	580	4	695	7	820	12	0,47	4,57	300	< 1,0	61	29
MCP-NY-0 015	1/2	230 V-I	760	7	890	10	1 030	15	0,61	5,57	300	< 1,0	66	32
MCP-NY-1 015	1/2	230 V-I	880	8	1 055	12	1 250	21	0,68	5,84	600	< 1,0	72	32
MCP-NY-1 026	3/4	230 V-I	1 180	11	1 435	18	1 710	28	0,91	9,54	600	< 1,0	79	30
MCP-NY-1 033	1	230 V-I	1 490	17	1 760	26	2 070	40	1,03	9,68	600	< 1,0	83	33

230 V-I-50 Hz | Baja temperatura | R-449A

Serie / Modelo	Compresor		Potencia frigorífica / Volumen cámara, según temperatura de cámara ⁽¹⁾						Potencia absorb. nominal (kW)	Intens. máxima absorb. (A)	Caudal evap. (m³/h)	Carga refrig. (kg) ⁽²⁾	Peso (kg)	Nivel presión sonora dB(A) ⁽³⁾
	CV	Tensión	-25 °C		-20 °C		-15 °C							
			W	m³	W	m³	W	m³						
BCP-NG-0 018	5/8	230 V-I	390	1	490	2	585	3	0,67	7,17	300	< 1,0	67	31
BCP-NG-1 026	3/4	230 V-I	640	3	810	7	960	10	1,00	8,64	600	< 1,0	74	31
BCP-NG-1 034	1 1/4	230 V-I	790	4	950	10	1 120	12	1,27	11,08	600	< 1,0	80	33

Opcionales

- Tratamiento anticorrosión en epoxi de la batería de evaporación.
- Otros refrigerantes.

Consultar

Dimensiones

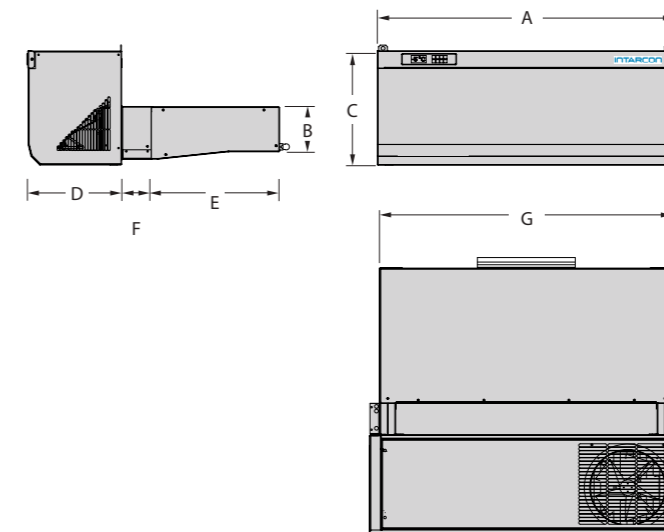

Dimensiones (mm)	A	B	C	D	E	F	G
serie 0	1 005	152	380	315	450	100	940
serie 1	1 005	152	380	315	450	100	940

⁽¹⁾ Las prestaciones nominales están referidas al funcionamiento con temperaturas de cámara de 0 °C (MT) o -20 °C (BT), y temperatura exterior de 35 °C. Volumen de cámara recomendado para cámaras con suelo y aislamiento de 80 mm en MT o 100 mm en BT, densidad de mercancía de 250 kg/m³ con una rotación diaria del 10 % a una temperatura de entrada de 25 °C en MT y -15 °C en BT.

⁽²⁾ Equipos con carga inferior a 5 toneladas de CO₂ equivalente (3,8 kg de R-134a o R-449A) exentos de comprobación de fugas (RD 552/2019).

⁽³⁾ Nivel sonoro máximo referido a nivel de presión acústica en dB(A), medido en campo abierto a 10 m de distancia de la fuente.

Marcos de montaje

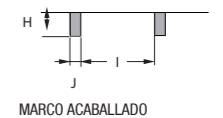

Dimensiones (mm)	H	I	J
serie 0	185	828	58
serie 1	185	828	58



Descripción Equipos semicompactos para cámaras frigoríficas de pequeño y mediano tamaño, formados por una unidad condensadora horizontal y una unidad evaporadora de bajo perfil, doble flujo o de tipo cúbico.

- Características**
- Alimentación 230 V-I-50 Hz o 400 V-III-50 Hz. Disponible 60 Hz. (Otras tensiones consultar)
 - Carga reducida de refrigerante R-134a o R-449A.
 - Compresor hermético alternativo (con aislamiento acústico en modelos trifásicos).
 - Presostatos de alta y baja presión.
 - Recipiente de líquido.
 - Precarga de refrigerante para hasta 10 m de tubería.
 - Expansión por válvula termostática.
 - Desescarche por resistencia eléctrica (excepto serie ASH).
 - Bandeja de condensados en acero inoxidable.
 - Conexiones de tipo Flare (hasta 3/8" - 3/4") y válvulas de servicio.
 - Interconexión eléctrica de 10 m incluida (excepto serie 4 y 40 a 54).
 - Protección magnetotérmica de motores.
 - Regulación electrónica multifunción con mando a distancia y control de condensación digital.
 - Inyección de líquido en equipos de baja temperatura con R-449A.

- Serie SH-N Unidad condensadora axial y unidad evaporadora de bajo perfil.
- Serie SH-Q Unidad condensadora axial y unidad evaporadora de tipo cúbico.
- Serie SH-C Unidad condensadora centrifuga y unidad evaporadora de bajo perfil.
- Serie SH-CQ Unidad condensadora centrifuga y unidad evaporadora de tipo cúbico.
- Serie SH-D Unidad condensadora axial y unidad evaporadora de doble flujo.
- Serie SH-CD Unidad condensadora centrifuga y unidad evaporadora de doble flujo.

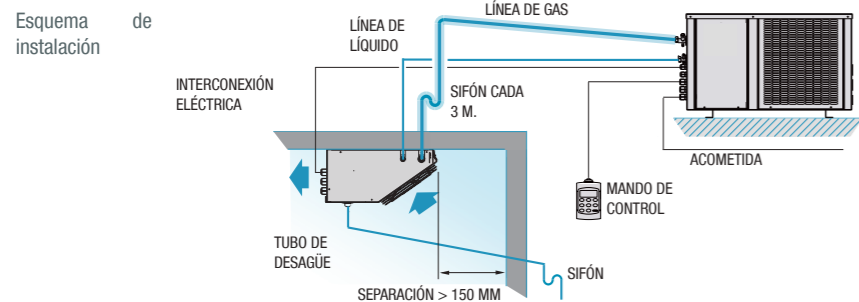

Distancia vertical máxima entre unidades de 15 m en caso de que la unidad condensadora esté situada a mayor altura que la unidad evaporadora, y de 6 m en caso contrario.
*Pendiente mínima del tubo de desagüe del 20% para modelos de baja temperatura.

- Equipos certificados en fábrica sin necesidad de ensayos in situ. (Reglamento Seguridad de Instalaciones Frigoríficas)
- Diseño tropicalizado para temperatura ambiente de 45°C.
- Válvula de expansión termostática.
- Precarga de refrigerante incluida.
- Equipos exentos de control de fugas

Controlador electrónico

Los equipos intarsplit incorporan de serie el avanzado controlador electrónico XM670K.



- Mando multifunción de control digital a distancia.
- Control de temperatura con registro de temperaturas máxima y mínima.
- Posibilidad de interconexión y sincronización de hasta 8 equipos en red LAN, gestionados con un solo mando de control.

Control de condensación digital

De serie en toda la gama intarsplit, protege al equipo frente a bajas temperaturas exteriores ocasionales. Para funcionamientos prolongados con baja temperatura exterior se recomienda instalar el control de condensación proporcional (opcional en series 3 y 33 en adelante).

Resistencia de cárter (opcional)

Se recomienda la inclusión de la resistencia de cárter opcional en todos los equipos instalados en el exterior.

Versión centrifuga

Los equipos de la serie intarsplit centrifugo incorporan una turbina centrifuga que permite la conducción al exterior del aire caliente de condensación mediante conductos de aire.

CONDUCTO DE EXTRACCIÓN DEL AIRE CALIENTE DE CONDENSACIÓN

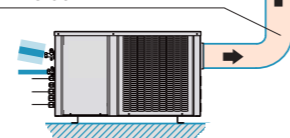

Interconexiones eléctricas (modelos SH-N/-C)

Para la interconexión de las unidades condensadora y evaporadora se han de prever las siguientes secciones de cable para 10 m de longitud.

Tensión	230 V-I-50 Hz	400 V-III-50 Hz
Sondas	4 x 1 mm ²	
Maniobra	2 x 1 mm ²	3 x 1 mm ²
Desescarche	2 x 1,5 mm ² + T	4 x 1,5 mm ² + T
Mando	2 x 1 mm ²	
Interruptor puerta*	2 x 1 mm ²	
Resistencia de puerta	2 x 1 mm ² en BT	
Luz cámara*	2 x 1 mm ² + T	

* Opcional no incluido. Para conocer interconexiones eléctricas de cada modelo, ver manual técnico.

230 V-I-50 Hz* / 400 V-III-50 Hz | **Media temperatura** | R134a / R449A

SERIE / MODELO AXIALES	CV	TENSIÓN	POTENCIA FRIGORÍFICA / VOLUMEN CÁMARA, SEGÚN TEMPERATURA DE CÁMARA ⁽¹⁾						POTENCIA ABSORB. NOMINAL (kW)	INTENS. MÁXIMA ABSORB. (A)	CAUDAL EVAP. (m ³ /h)	CONEXIÓN FRIGORÍFICA LIQ.- GAS	CARGA REFRIG. (kg)	PESO (kg)	NIVEL PRESIÓN SONORA dB(A) ⁽²⁾
			0°C		5°C		10°C								
MSH-NY-00 010	3/8	230 V-I	643	5,1	788	8,5	945	13	0,46	4,6	300	1/4"-3/8"	< 1,5	37+12	29
MSH-NY-00 015	1/2	230 V-I	832	7,2	1 010	10	1 193	19	0,56	5,6	300	1/4"-3/8"	< 1,5	40+12	32
MSH-NY-11 015	1/2	230 V-I	988	8,2	1 220	12	1 474	23	0,58	5,6	550	1/4"-1/2"	< 1,5	41+16	32
MSH-NY-11 026	3/4	230 V-I	1 250	12	1 533	18	1 827	30	0,82	9,3	550	1/4"-1/2"	< 1,5	48+16	30
MSH-NY-11 033	1	230 V-I	1 481	16	1 790	24	2 116	41	0,93	9,5	550	1/4"-1/2"	< 1,5	50+16	33
MSH-NY-22 033	1	230 V-I	1 922	23	2 368	36	2 846	60	1,06	10,0	1 050	1/4"-5/8"	< 2,0	53+24	34
MSH-NY-22 053	1 1/2	230 V-I *	2 363	31	2 882	48	3 455	73	1,45	12,6	1 050	1/4"-5/8"	< 2,0	63+24	38
MSH-NY-33 053	1 1/2	230 V-I *	2 688	40	3 318	63	4 069	100	1,55	13,2	1 725	1/4"-3/4"	< 3,5	82+45	38
MSH-NY-33 074	2	230 V-I *	3 518	47	4 347	71	5 198	110	1,93	17,2	1 725	1/4"-3/4"	< 3,5	84+45	44
MSH-NY-43 086	4	400 V-III	4 379	66	5 366	100	6 421	165	2,39	14,9	1 725	3/8"-7/8"	< 5,0	107+55	48
MSH-NY-44 108	5	400 V-III	5 628	88	6 888	140	8 274	220	3,05	19,2	3 100	3/8"-7/8"	< 5,0	109+55	45
MSH-NY-44 136	6 1/2	400 V-III	6 862	115	8 311	170	9 881	260	3,77	23,2	3 100	3/8"-1 1/8"	< 5,5	112+55	44
MSH-NG-0 008	1/3	230 V-I	758	5,1	900	8,5	1 071	13	0,47	5,1	300	1/4"-3/8"	< 1,5	38+12	32
MSH-NG-0 010	3/8	230 V-I	893	6,1	1 042	10	1 223	15	0,58	4,8	300	1/4"-3/8"	< 1,5	40+12	30
MSH-NG-0 012	1/2	230 V-I	980	7,2	1 135	12	1 324	19	0,65	5,6	300	1/4"-3/8"	< 1,5	41+12	32
MSH-NG-1 014	1/2	230 V-I	1 100	10	1 313	16	1 564	26	0,79	6,7	550	1/4"-1/2"	< 1,5	44+16	32
MSH-NG-1 016	5/8	230 V-I	1 216	12	1 451	18	1 734	30	0,85	7,6	550	1/4"-1/2"	< 1,5	53+16	34
MSH-NG-1 018	3/4	230 V-I	1 404	14	1 653	22	1 954	35	1,00	8,9	550	1/4"-1/2"	< 1,5	54+16	35
MSH-NG-1 024	1	230 V-I	1 528	16	1 811	24	2 140	41	1,01	11,1	550	1/4"-1/2"	< 1,5	54+16	35
MSH-NG-2 024	1	230 V-I	2 020	23	2 424	36	2 896	60	1,27	11,6	1 050	1/4"-1/2"	< 1,5	65+24	36
MSH-NG-2 026	1 1/4	230 V-I *	2 230	26	2 640	41	3 131	64	1,36	12,0	1 050	1/4"-1/2"	< 1,5	66+24	38
MSH-NG-2 034	1 1/2	230 V-I *	2 543	31	2 985	48	3 516	73	1,80	16,6	1 050	1/4"-5/8"	< 1,5	66+24	40
MSH-NG-3 034	1 1/2	230 V-I *	3 091	40	3 674	63	4 364	100	1,67	17,0	1 725	1/4"-5/8"	< 3,5	74+45	39
MSH-NG-3 038	1 3/4	400 V-III	3 459	47	4 060	71	4 786	110	1,53	7,8	1 725	1/4"-5/8"	< 4,0	71+45	40
MSH-NG-4 048	2	400 V-III	4 494	66	5 350	98	6 358	155	2,61	10,5	1 725	3/8"-3/4"	< 5,5	95+45	41
MSH-NG-4 054	2 1/4	400 V-III	4 949	74	5 847	110	6 916	170	2,80	11,0	1 725	3/8"-3/4"	< 5,5	96+45	41

230 V-I-50 Hz* / 400 V-III-50 Hz | **Baja temperatura** | R449A

SERIE / MODELO AXIALES	CV	TENSIÓN	POTENCIA FRIGORÍFICA / VOLUMEN CÁMARA, SEGÚN TEMPERATURA DE CÁMARA ⁽¹⁾						POTENCIA ABSORB. NOMINAL (kW)	INTENS. MÁXIMA ABSORB. (A)	CAUDAL EVAP. (m ³ /h)	CONEXIÓN FRIGORÍFICA LIQ.- GAS	CARGA REFRIG. (kg)	PESO (kg)	NIVEL PRESIÓN SONORA dB(A) ⁽²⁾
			-25°C		-20°C		-15°C								
BSH-NG-0 018	5/8	230 V-I	422	0,9	537	1,8	658	3,9	0,60	4,8	300	1/4"-1/2"	< 1,5	41+12	31
BSH-NG-1 026	3/4	230 V-I	569	2,1	711	4,2	900	7,3	0,84	8,7	550	1/4"-1/2"	< 2,5	55+16	31
BSH-NG-1 034	1 1/4	230 V-I	622	3,0	858	5,9	1 038	10	1,05	11,2	550	1/4"-1/2"	< 2,5	56+16	33
BSH-NG-2 034	1 1/4	230 V-I	815	4,0	1 056	8,0	1 377	14	1,18	11,5	1 050	1/4"-1/2"	< 2,5	66+24	35
BSH-NG-2 055	1 3/4	230 V-I *	1 175	8	1 675	16	2 090	28	1,7	17,5	1 050	1/4"-5/8"	< 2,5	66+24	41
BSH-NG-2 075	2 1/2	230 V-I *	1 620	13	2 035	21	2 435	34	2,1	25,5	1 050	1/4"-5/8"	< 3,5	66+24	44
BSH-NG-3 075	2 1/2	230 V-I *	1 795	15	2 410	26	3 020	46	2,3	26,3	1 725	1/4"-5/8"	< 3,5	85+43	44
BSH-NG-3 096	3 1/2	400 V-III	2 046	23	2 745	37	3 435	62	2,18	12,4	1 725	3/8"-3/4"	< 3,5	85+45	49
BSH-NG-4 108	4 1/4	400 V-III	2 851	34	3 588	55	4 378	94	3,18	15,5	1 725	3/8"-7/8"	< 5,5	107+45	47
BSH-NG-4 136	5	400 V-III	3 289	42	4 064	67	4 895	110	4,37	17,4	1 725	3/8"-7/8"	< 5,5	107+45	42

Opcionales

- Cambio a alimentación 400 V-III-50 Hz.
- Resistencia de cárter.
- Control de condensación proporcional: Versión axial (N); series 3/33 y 4/43/44 Versión centrifuga (C); series 4/43/44
- Impulsión vertical (equipos centrifugos).
- Adaptación de impulsión de aire a conducto circular.
- Separador de aceite.
- Recubrimiento anticorrosión de batería evaporador.
- Recubrimiento anticorrosión de batería condensador.
- Mando multifunción de mayor tamaño.

Dimensiones Evaporador

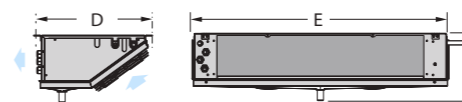

Dimensiones Condensador

EMBODADURA TURBINA (VERSION CENTRIFUGA)

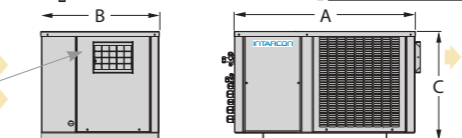

SERIE / MODELO CENTRIFUGOS			CAUDAL COND. (m ³ /h)	PED. ⁽³⁾ (mmca)
MSH-CY-00 010	375	8		
MSH-CY-00 015	375	8		
MSH-CY-11 015	575	8		
MSH-CY-11 026	575	8		
MSH-CY-11 033	575	8		
MSH-CY-22 033	1 000	12		
MSH-CY-22 053	1 000	12		
MSH-CY-33 053	1 500	14		
MSH-CY-33 074	1 500	14		
MSH-CY-43 086	3 500	10		
MSH-CY-44 108	3 500	10		
MSH-CY-44 136	3 500	10		
MSH-CG-0 008	375	8		
MSH-CG-0 010	375	8		
MSH-CG-0 012	375	8		
MSH-CG-1 014	575	8		
MSH-CG-1 016	575	8		
MSH-CG-1 018	575	8		
MSH-CG-1 024	575	8		
MSH-CG-2 024	1 000	12		
MSH-CG-2 026	1 000	12		
MSH-CG-2 034	1 000	12		
MSH-CG-3 034	1 500	14		
MSH-CG-3 038	1 500	14		
MSH-CG-4 048	3 500	10		
MSH-CG-4 054	3 500	10		

SERIE / MODELO CENTRIFUGOS			CAUDAL COND. (m ³ /h)	PED. ⁽³⁾ (mmca)
BSH-CG-0 018	375	8		
BSH-CG-1 026	575	8		
BSH-CG-1 034	575	8		
BSH-CG-2 034	1 000	12		
BSH-CG-2 055	1 000	12		
BSH-CG-2 075	1 000	12		
BSH-CG-3 075	1 500	14		
BSH-CG-3 096	1 500	14		
BSH-CG-4 108	3 500	10		
BSH-CG-4 136	3 500	10		

⁽¹⁾ Las prestaciones nominales están referidas al funcionamiento con temperatura de cámara de 0°C (MT) y -20°C (BT), y temperatura exterior de 35°C. Volumen de cámara estimado según condiciones de las bases de cálculo (pág. VI).

⁽²⁾ Nivel sonoro referido a nivel de presión acústica en dB(A), medido en campo abierto a 10 m de distancia de la fuente.

⁽³⁾ Presión estática disponible en conductos de expulsión.

* Unidades disponibles en tensión 400 V-III-50 Hz.

Dimensiones (mm)	A	B	C	D	E	F	Ventiladores evaporador	Embocadura turbina
series 0 y 00	600	395	355	417	549	185	1x Ø 172	185 x 115
series 1 y 11	665	435	416	430	643	235	1x Ø 200	185 x 115
series 2 y 22	835	435	500	430	993	235	2x Ø 200	230 x 130
series 3 y 33	925	580	515	508	1 691	235	3x Ø 254	266 x 236
series 4 y 43	1 000	615	5					

230 V-I-50 Hz* / 400 V-III-50 Hz | Media temperatura | R134a / R449A

SERIE / MODELO AXIALES	CV	TENSIÓN	POTENCIA FRIGORÍFICA / VOLUMEN CÁMARA, SEGÚN TEMPERATURA DE CÁMARA ⁽¹⁾						POTENCIA ABSORB. NOMINAL (kW)	INTENS. MÁXIMA ABSORB. (A)	CAUDAL EVAP. (m³/h)	CONEXIÓN FRIGORÍFICA LIQ.-GAS	CARGA REFRIG. (kg)	PESO (kg)	NIVEL PRESIÓN SONORA dB(A) ⁽²⁾
			0°C		5°C		10°C								
			W	m³	W	m³	W	m³							
MSH-QY-30 068	3 1/2	400 V-III	3 854	54	4 646	59	5 513	84	2,00	12,0	2 100	1/4"-3/4"	< 4,0	74+43	37
MSH-QY-40 086	4	400 V-III	4 431	63	5 418	68	6 500	100	2,35	14,3	2 100	3/8"-7/8"	< 5,0	107+43	48
MSH-QY-41 108	5	400 V-III	5 324	71	6 500	80	7 775	110	2,77	17,3	2 700	3/8"-7/8"	< 5,0	109+56	45
MSH-QY-42 136	6 1/2	400 V-III	7 235	110	8 773	180	10 474	280	3,85	22,0	4 150	3/8"-1 1/8"	< 5,0	112+72	44
MSH-QY-53 171	8	400 V-III	7 830	135	9 535	185	11 520	300	4,25	24,1	5 200	3/8"-1 1/8"	< 5,5	162+89	50
MSH-QY-53 215	10	400 V-III	9 450	175	11 435	230	13 740	350	5,01	30,5	6 200	3/8"-1 1/8"	< 5,5	166+94	49
MSH-QY-54 271	13	400 V-III	12 400	240	14 760	320	17 420	400	7,13	40,2	8 300	1/2"-1 3/8"	< 5,5	171+118	48
MSH-QG-30 034	1 1/2	230 V-I*	3 409	39	4 054	62	4 797	99	1,61	16,3	2 100	1/4"-5/8"	< 3,5	74+43	38
MSH-QG-30 038	1 3/4	400 V-III	3 647	46	4 301	70	5 063	110	1,79	7,1	2 100	1/4"-5/8"	< 3,5	71+43	40
MSH-QG-40 048	2	400 V-III	4 752	67	5 559	99	6 554	159	2,42	9,8	2 100	3/8"-3/4"	< 4,5	95+43	36
MSH-QG-40 054	2 1/2	400 V-III	5 203	76	6 060	113	7 106	178	2,61	10,3	2 100	3/8"-3/4"	< 5,0	96+43	36
MSH-QG-41 060	3	400 V-III	6 049	86	7 038	128	8 260	198	3,07	11,3	2 700	1/2"-3/4"	< 5,0	97+56	36
MSH-QG-41 068	3 1/2	400 V-III	6 545	113	7 581	163	8 866	253	3,44	12,3	2 700	1/2"-3/4"	< 5,0	98+56	35
MSH-QG-52 086	4	400 V-III	8 056	125	9 542	185	11 320	315	3,87	15,0	4 150	1/2"-7/8"	< 5,0	135+72	48
MSH-QG-52 108	5	400 V-III	9 386	160	11 011	220	12 991	375	4,90	18,0	4 150	1/2"-7/8"	< 7,0	157+72	45
MSH-QG-53 136	6 1/2	400 V-III	11 894	190	13 856	260	16 173	430	6,67	21,0	6 200	1/2"-1 1/8"	< 9,0	140+94	44

230 V-I-50 Hz* / 400 V-III-50 Hz | Baja temperatura | R449A

SERIE / MODELO AXIALES	CV	TENSIÓN	POTENCIA FRIGORÍFICA / VOLUMEN CÁMARA, SEGÚN TEMPERATURA DE CÁMARA ⁽¹⁾						POTENCIA ABSORB. NOMINAL (kW)	INTENS. MÁXIMA ABSORB. (A)	CAUDAL EVAP. (m³/h)	CONEXIÓN FRIGORÍFICA LIQ.-GAS	CARGA REFRIG. (kg)	PESO (kg)	NIVEL PRESIÓN SONORA dB(A) ⁽²⁾
			-25°C		-20°C		-15°C								
			W	m³	W	m³	W	m³							
BSH-QG-30 075	2	230 V-I*	1 765	14	2 425	27	3 050	47	2,3	25,1	2 100	1/4"-5/8"	< 3,5	85+43	44
BSH-QG-30 096	3 1/2	400 V-III	2 354	22	2 925	36	3 533	61	2,34	11,2	2 100	1/4"-3/4"	< 3,5	85+43	49
BSH-QG-41 108	4 1/4	400 V-III	2 988	34	3 799	58	4 656	99	2,94	14,4	2 700	3/8"-7/8"	< 5,0	107+56	47
BSH-QG-42 136	5	400 V-III	4 205	51	5 119	85	6 092	144	4,16	17,3	4 150	3/8"-7/8"	< 5,0	107+72	42
BSH-QG-53 215	7 1/2	400 V-III	5 692	80	7 300	120	8 976	200	6,08	25,0	5 200	1/2"-1 1/8"	< 7,0	166+89	49
BSH-QG-53 271	10	400 V-III	7 329	110	9 048	150	10 877	220	7,71	30,0	6 200	1/2"-1 1/8"	< 7,5	166+94	49

series MSH / BSH

SERIE / MODELO CENTRIFUGOS	CAUDAL COND. (m³/h)	PE.D. ⁽³⁾ (mmca)
MSH-CQY-30 068	1 500	14
MSH-CQY-40 086	3 500	10
MSH-CQY-41 108	3 500	10
MSH-CQY-42 136	3 500	10
MSH-CQY-53 171	3 600	10
MSH-CQY-53 215	3 600	10
MSH-CQY-54 271	3 600	10
MSH-CQG-30 034	1 500	14
MSH-CQG-30 038	1 500	14
MSH-CQG-40 048	3 500	10
MSH-CQG-40 054	3 500	10
MSH-CQG-41 060	3 500	10
MSH-CQG-41 068	3 500	10
MSH-CQG-52 086	3 600	12
MSH-CQG-52 108	3 600	12
MSH-CQG-53 136	3 600	12

SERIE / MODELO CENTRIFUGOS	CAUDAL COND. (m³/h)	PE.D. ⁽³⁾ (mmca)
BSH-CQG-30 075	1 500	14
BSH-CQG-30 096	1 500	14
BSH-CQG-41 108	3 500	10
BSH-CQG-42 136	3 500	10
BSH-CQG-53 215	3 600	12
BSH-CQG-53 271	3 600	12

230 V-I-50 Hz* / 400 V-III-50 Hz | Alta temperatura | R134a / R449A

SERIE / MODELO AXIALES	CV	TENSIÓN	POTENCIA FRIGORÍFICA / VOLUMEN CÁMARA, SEGÚN TEMPERATURA DE CÁMARA ⁽¹⁾						POTENCIA ABSORB. NOMINAL (kW)	INTENS. MÁXIMA ABSORB. (A)	CAUDAL EVAP. (m³/h)	CONEXIÓN FRIGORÍFICA LIQ.-GAS	CARGA REFRIG. (kg)	PESO (kg)	NIVEL PRESIÓN SONORA dB(A) ⁽²⁾
			9°C		12°C		15°C								
			W	m³	W	m³	W	m³							
ASH-DY-11 015	1/2	230 V-I	1 555	14	1 733	19	1 928	26	0,75	5,9	1 100	1/4"-1/2"	< 2,0	48+32	27
ASH-DY-11 026	3/4	230 V-I	1 985	18	2 221	24	2 462	33	0,99	9,6	1 100	1/4"-1/2"	< 2,0	51+32	33
ASH-DY-11 033	1	230 V-I	2 378	22	2 636	29	2 903	40	1,37	9,8	1 100	1/4"-5/8"	< 2,0	51+32	34
ASH-DY-22 033	1	230 V-I	2 961	28	3 329	38	3 717	51	1,30	10,7	1 800	1/4"-5/8"	< 2,5	54+45	34
ASH-DY-22 053	1 1/2	230 V-I*	3 738	35	4 169	48	4 625	63	2,04	13,3	1 800	3/8"-3/4"	< 2,5	55+45	39
ASH-DY-33 053	1 1/2	230 V-I*	4 211	42	4 709	56	5 234	76	2,05	13,6	3 150	3/8"-3/4"	< 4,0	74+65	39
ASH-DY-33 074	2	230 V-I*	5 502	58	6 148	77	6 830	104	2,74	17,6	3 150	3/8"-3/4"	< 4,0	71+65	39
ASH-DY-43 086	4	400 V-III	7 124	74	8 001	98	8 915	131	3,16	15,4	3 150	3/8"-7/8"	< 6,5	107+65	41
ASH-DY-43 108	5	400 V-III	8 216	85	9 177	111	10 206	148	3,76	18,4	3 150	3/8"-7/8"	< 6,0	109+65	43
ASH-DY-44 108	5	400 V-III	8 873	92	9 954	121	11 062	160	4,08	18,4	5 700	3/8"-7/8"	< 6,0	112+70	43
ASH-DY-44 136	6 1/2	400 V-III	10 988	114	12 206	148	13 498	195	4,57	22,4	5 700	1/2"-1 1/8"	< 6,0	112+70	45
ASH-DG-1 010	3/8	230 V-I	1 237	10	1 341	14	1 455	19	0,77	5,2	1 100	1/4"-3/8"	< 2,5	42+32	32
ASH-DG-1 012	1/2	230 V-I	1 419	12	1 535	16	1 664	22	0,82	6,2	1 100	1/4"-3/8"	< 2,5	43+32	28
ASH-DG-2 014	1/2	230 V-I	1 829	16	1 965	22	2 109	29	0,95	7,4	1 100	1/4"-1/2"	< 3,0	35+32	32
ASH-DG-2 016	5/8	230 V-I	2 014	18	2 169	24	2 338	33	1,03	8,3	1 100	1/4"-1/2"	< 3,0	54+32	34
ASH-DG-2 018	3/4	230 V-I	2 309	22	2 481	28	2 675	38	1,23	9,6	1 100	1/4"-1/2"	< 3,0	55+32	35
ASH-DG-2 024	1	230 V-I	2 988	27	3 228	36	3 480	47	1,61	11,8	1 800	3/8"-5/8"	< 3,0	55+45	36
ASH-DG-3 026	1 1/4	230 V-I*	3 434	33	3 709	42	3 996	57	1,76	11,7	1 800	3/8"-5/8"	< 3,5	74+45	38
ASH-DG-3 034	1 1/2	230 V-I*	4 376	41	4 692	54	5 048	72	2,26	16,5	1 800	3/8"-5/8"	< 4,0	74+45	41
ASH-DG-3 038	1 3/4	400 V-III	5 011	47	5 356	62	5 733	85	2,15	7,3	1 800	3/8"-5/8"	< 4,0	71+45	40
ASH-DG-4 048	2	400 V-III	6 667	66	7 151	86	7 673	115	2,98	10,2	3 150	1/2"-3/4"	< 5,5	95+65	41
ASH-DG-4 054	2 1/4	400 V-III	7 362	73	7 875	95	8 446	125	3,23	10,7	3 150	1/2"-3/4"	< 6,0	96+65	41
ASH-DG-4 060	3	400 V-III	8 369	82	8 974	105	9 614	140	3,96	12,2	3 800	1/2"-7/8"	< 6,0	97+65	35
ASH-DG-4 068	3 1/2	400 V-III	9 113	89	9 753	115	10 442	150	4,47	13,2	3 800	1/2"-7/8"	< 6,0	98+65	39

serie ASH

SERIE / MODELO CENTRIFUGOS	CAUDAL COND. (m³/h)	PE.D. ⁽³⁾ (mmca)
ASH-CDY-11 015	575	8
ASH-CDY-11 026	575	8
ASH-CDY-11 033	575	8
ASH-CDY-22 033	1 000	12
ASH-CDY-22 053	1 000	12
ASH-CDY-33 053	1 500	14
ASH-CDY-33 074	1 500	14
ASH-CDY-43 086	3 500	10
ASH-CDY-43 108	3 500	10
ASH-CDY-44 108	3 500	10
ASH-CDY-44 136	3 500	10
ASH-CDG-1 010	575	8
ASH-CDG-1 012	575	8
ASH-CDG-2 014	1 000	12
ASH-CDG-2 016	1 000	12
ASH-CDG-2 018	1 000	12
ASH-CDG-2 024	1 000	12
ASH-CDG-3 026	1 500	14
ASH-CDG-3 034	1 850	14
ASH-CDG-3 038	1 850	14
ASH-CDG-4 048	3 500	10
ASH-CDG-4 054	3 500	10
ASH-CDG-4 060	3 500	10
ASH-CDG-4 068	3 500	10

Opcionales

- Cambio a alimentación 400 V-III-50 Hz.
- Resistencia de cárter.
- Control de condensación proporcional: Versión axial (Q). Versión centrífuga (CQ): series 40/41/42/52/53/54.
- Impulsión vertical (equipos centrifugos).
- Adaptación de impulsión de aire a conducto circular.
- Separador de aceite.
- Recubrimiento anticorrosión de batería evaporador.
- Recubrimiento anticorrosión de batería condensador.
- Mando multifunción de mayor tamaño.

⁽¹⁾ Las prestaciones nominales están referidas al funcionamiento con temperatura de cámara de 0°C (MT) y -20°C (BT), y temperatura exterior de 35°C. Volumen de cámara estimado según condiciones de las bases de cálculo (pág. VI).

⁽²⁾ Nivel sonoro referido a nivel de presión acústica en dB(A), medido en campo abierto a 10 m de distancia de la fuente.

⁽³⁾ Presión estática disponible en conductos de expulsión.

* Unidades disponibles en tensión 400 V-III-50 Hz.

Dimensiones Evaporador

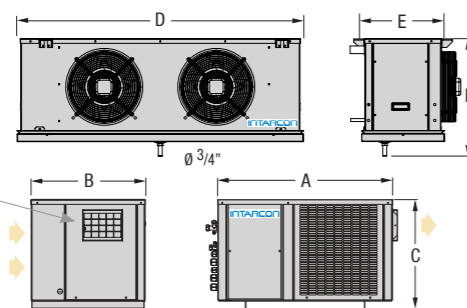

Dimensiones Condensador

Dimensiones (mm)	A	B	C	D	E	F	Ventiladores evaporador	Embocadura turbina
serie 30	925	580	515	880	455	581	1x Ø 350	266 x 236
serie 40	1 000	615	585	880	455	581	1x Ø 350	305 x 266
serie 41	1 000	615	585	1 230	455	581	1x Ø 350	305 x 266
serie 42	1 000	615	585	1 530	455	581	2x Ø 350	305 x 266
serie 52	1 290	755	656	1 530	455	581	2x Ø 350	305 x 266
MSH-QY-53 171	1 290	755	656	1 930	455	581	2x Ø 350	305 x 266
serie 53	1 290	755	656	1 930	455	581	3x Ø 350	305 x 266
serie 5								



Descripción Equipos semicompactos para cámaras frigoríficas de pequeño y mediano tamaño, formados por una unidad condensadora silenciosa y una unidad evaporadora de bajo perfil, plafón de doble flujo o tipo cúbico.

- Características**
- Alimentación 230 V-I-50 Hz o 400 V-III-50 Hz. Disponible 60 Hz.
 - Carga de refrigerante R-134A o R-449A reducida.
 - Compresor hermético alternativo.
 - Doble aislamiento acústico del compresor.
 - Amplia superficie de condensación en L (recta en series 0 y 1).
 - Ventiladores de condensación de baja velocidad.
 - Control de condensación proporcional (opcional en versiones -N).
 - Presostatos de alta y baja presión.
 - Silenciador de descarga (a partir de 1 CV) y resistencia de cárter.
 - Recipiente de líquido.
 - Precarga de refrigerante para hasta 10 m de tubería.
 - Evaporador: bajo perfil (versión -N) o tipo cúbico (versión -Q).
 - Válvula termostática y válvula solenoide integradas.
 - Desescarche por resistencia eléctrica (excepto serie ASF).
 - Bandeja de condensados en acero inoxidable.
 - Conexiones de tipo Flare (hasta 1/2"-3/4") y válvulas de servicio.
 - Protección magnetotérmica.
 - Regulación electrónica multifunción con mando a distancia y control de condensación digital.
 - Inyección de líquido en modelos de baja temperatura con R-449A.

Esquema de instalación

Distancia vertical máxima entre unidades de 15 m en caso de que la unidad condensadora esté situada a mayor altura que la unidad evaporadora, y de 6 m en caso contrario.
* Inclinación mínima del tubo de desagüe del 20 % para modelos de baja temperatura.

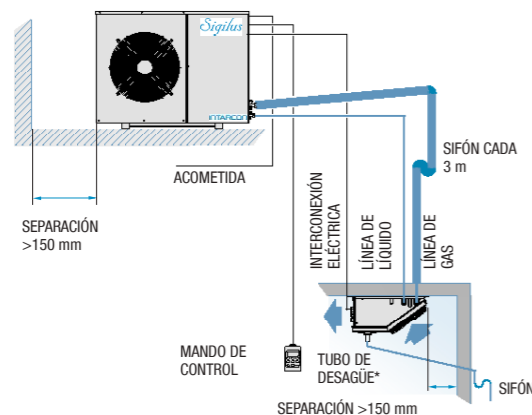

- Equipos certificados en fábrica sin necesidad de ensayos in situ (RSIF).
- Unidad condensadora silenciosa.
- Diseño tropicalizado para temperatura ambiente de 50 °C.
- Válvula de expansión termostática.
- Control de condensación proporcional (opcional en versiones bajo perfil).
- Precarga de refrigerante incluida.
- Equipos exentos de control de fugas.

Controlador electrónico
Los equipos Sigilus incorporan de serie el avanzado controlador electrónico XM670K:



- Mando multifunción de control digital a distancia.
- Control de temperatura con registro de temperaturas máxima y mínima.
- Posibilidad de interconexión y sincronización de hasta 8 equipos en red LAN, gestionados con un solo mando de control.

- Triples insonorización acústica
Las unidades condensadoras de la serie Sigilus incorporan una triple insonorización acústica:
- Compartimento del compresor insonorizado y separado del flujo de aire.
 - Compresor hermético en camisa acústica y silenciador de descarga.
 - Ventiladores silenciosos de baja velocidad sobre estructura antivibratoria.

Control de condensación proporcional
Incorporamos en la serie Sigilus (opcional para las unidades con evaporador de bajo perfil) un control de condensación proporcional por variación de velocidad para funcionamiento prolongados con baja temperatura exterior.

Interconexiones eléctricas
Para la interconexión de las unidades condensadora y evaporadora se han de prever las siguientes secciones de cable para 10 m de longitud (mangueras no incluidas):

Tensión	230 V-I-50 Hz	400 V-III-50 Hz
Sondas	4 x 1 mm ²	
Maniobra	2 x 1 mm ²	3 x 1 mm ²
Desescarche	2 x 1,5 mm ² + T	4 x 1,5 mm ² + T
Mando	2 x 1 mm ²	
Interruptor puerta*	2 x 1 mm ²	
Resistencia de puerta	2 x 1 mm ² en BT	
Luz cámara*	2 x 1 mm ² + T	

* Opcional no incluido.
Para conocer interconexiones eléctricas de cada modelo, ver manual técnico.

230 V-I-50 Hz* / 400 V-III-50 Hz | Media temperatura | R134a / R449A

SERIE / MODELO	COMPRESOR		POTENCIA FRIGORÍFICA / VOLUMEN CÁMARA, SEGÚN TEMPERATURA DE CÁMARA ⁽¹⁾								POTENCIA ABSORB. NOMINAL (kW)	INTENS. MÁXIMA ABSORB. (A)	VENT. EVAP.	CAUDAL EVAP. (m ³ /h)	CAUDAL COND. (m ³ /h)	CONEXIÓN FRIGORÍFICA LIQ.-GAS	CARGA REFRIG. (kg)	PESO (kg)	NIVEL PRESIÓN SONORA dB(A) ⁽²⁾
	CV	TENSIÓN	-5 °C		0 °C		5 °C		10 °C										
			W	m ³	W	m ³	W	m ³	W	m ³									
MSF-NY-00 010	3/8	230 V-I	497	2,9	637	5,0	788	8,8	945	13	0,41	4,2	1x Ø172	300	350	1/4"-3/8"	< 1,5	46+12	20
MSF-NY-00 015	1/2	230 V-I	653	3,6	832	7,4	1 004	11	1 188	16	0,51	5,2	1x Ø172	300	350	1/4"-3/8"	< 1,5	49+12	19
MSF-NY-11 015	1/2	230 V-I	805	4,7	1 031	10	1 296	14	1 582	28	0,56	5,6	1x Ø200	550	1 700	1/4"-1/2"	< 2,0	57+16	19
MSF-NY-11 026	3/4	230 V-I	1 076	9,0	1 412	16	1 738	25	2 084	40	0,80	9,2	1x Ø200	550	1 700	1/4"-1/2"	< 2,0	65+16	22
MSF-NY-12 033	1	230 V-I	1 475	13	1 859	20	2 289	35	2 741	57	1,02	9,7	2x Ø200	1 050	1 700	1/4"-5/8"	< 2,0	67+24	22
MSF-NY-12 053	1 1/2	230 V-I*	1 811	22	2 347	33	2 872	50	3 439	79	1,42	12,3	2x Ø200	1 050	1 700	1/4"-5/8"	< 2,0	77+24	27
MSF-NY-13 074	2	230 V-I*	2 772	30	3 528	50	4 363	76	5 229	125	1,94	17,2	3x Ø254	1 725	1 700	1/4"-3/4"	< 3,5	79+45	28
MSF-NY-23 086	4	400 V-III	3 355	39	4 384	65	5 376	108	6 437	160	2,18	14,1	3x Ø254	1 725	3 700	3/8"-7/8"	< 4,5	96+45	39
MSF-NY-24 108	5	400 V-III	4 347	58	5 649	90	6 920	138	8 316	220	2,83	18,2	4x Ø300	3 100	3 700	3/8"-7/8"	< 4,5	98+45	37
MSF-NY-24 136	6 1/2	400 V-III	5 486	75	6 899	110	8 363	150	9 949	280	3,55	22,2	4x Ø300	3 100	3 700	3/8"-1 1/8"	< 5,5	101+55	36
MSF-NY-34 171	8	400 V-III	6 080	88	7 613	130	9 240	200	10 978	350	4,16	25,2	4x Ø300	3 100	4 000	3/8"-1 1/8"	< 5,5	140+55	36
MSF-NG-0 008	1/3	230 V-I	611	2,9	759	5,0	915	8,8	1 103	13	0,43	5,1	1x Ø172	300	350	1/4"-3/8"	< 1,5	47+12	29
MSF-NG-0 010	3/8	230 V-I	739	3,6	894	6,1	1 056	10	1 254	15	0,53	4,8	1x Ø172	300	350	1/4"-3/8"	< 1,5	49+12	29
MSF-NG-0 012	1/2	230 V-I	818	4,7	981	7,4	1 153	12	1 358	21	0,63	5,6	1x Ø172	300	350	1/4"-3/8"	< 1,5	50+12	29
MSF-NG-1 014	1/2	230 V-I	882	8,0	1 095	12	1 322	20	1 585	34	0,77	6,5	1x Ø200	550	1 700	1/4"-1/2"	< 2,0	59+16	34
MSF-NG-1 016	5/8	230 V-I	972	10	1 210	15	1 462	24	1 759	40	0,81	7,4	1x Ø200	550	1 700	1/4"-1/2"	< 2,0	67+16	34
MSF-NG-1 018	3/4	230 V-I	1 397	12	1 649	19	1 915	28	2 245	45	0,94	8,7	1x Ø200	550	1 700	1/4"-1/2"	< 2,0	68+16	34
MSG-NG-2 024	1	230 V-I	1 513	14	1 958	22	2 420	35	2 958	57	1,26	11,1	2x Ø200	1 050	1 700	1/4"-1/2"	< 2,5	82+24	34
MSF-NG-2 026	1 1/4	230 V-I*	1 712	16	2 147	25	2 611	39	3 157	64	1,44	11,5	2x Ø200	1 050	1 700	1/4"-1/2"	< 2,5	83+24	34
MSF-NG-2 034	1 1/2	230 V-I*	2 120	21	2 606	33	3 117	50	3 730	79	1,83	16,1	2x Ø200	1 050	1 700	1/4"-5/8"	< 2,5	83+24	35
MSF-NG-3 038	1 3/4	400 V-III	2 770	29	3 394	46	4 078	71	4 894	112	1,89	8,1	3x Ø254	1 725	3 200	1/4"-5/8"	< 4,5	82+45	29
MSF-NG-4 048	2	400 V-III	3 368	39	4 231	62	5 158	92	6 225	145	2,34	9,6	3x Ø254	1 725	3 700	3/8"-3/4"	< 4,5	84+45	26
MSF-NG-4 054	2 1/4	400 V-III	3 792	47	4 671	70	5 640	105	6 780	160	2,54	10,1	3x Ø254	1 725	3 700	3/8"-3/4"	< 4,5	85+45	26

230 V-I-50 Hz* / 400 V-III-50 Hz | Baja temperatura | R449A

SERIE / MODELO	COMPRESOR		POTENCIA FRIGORÍFICA / VOLUMEN CÁMARA, SEGÚN TEMPERATURA DE CÁMARA ⁽¹⁾						POTENCIA ABSORB. NOMINAL (kW)	INTENS. MÁXIMA ABSORB. (A)	VENT. EVAP.	CAUDAL EVAP. (m ³ /h)	CAUDAL COND. (m ³ /h)	CONEXIÓN FRIGORÍFICA LIQ.-GAS	CARGA REFRIG. (kg)	PESO (kg)	NIVEL PRESIÓN SONORA dB(A) ⁽²⁾
	CV	TENSIÓN	-25 °C		-20 °C		-15 °C										
			W	m ³	W	m ³	W	m ³									
BSF-NG-0 018	5/8	230 V-I	486	1,1	613	2,3	749	4,1	0,50	4,7	1x Ø172	300	350	1/4"-1/2"	< 1,5	50+12	28
BSF-NG-1 026	3/4	230 V-I	763	3,2	952	7,0	1 155	13	0,82	8,5	1x Ø200	550	1 700	1/4"-1/2"	< 2,0	67+16	34
BSF-NG-2 034	1 1/4	230 V-I	930	3,9	1 107	8,1	1 437	15	1,18	11,3	2x Ø200	1 050	1 700	1/4"-1/2"	< 2,0	83+16	34
BSF-NG-2 055	1 3/4	230 V-I*	1 260	9	1 710	16	2 190	30	1,7	17,5	2x Ø200	1 050	1 700	1/4"-5/8"	< 2,5	85+24	36
BSF-NG-2 075	2 1/2	230 V-I*	1 655	13	2 130	22	2 625	38	2,1	25,5	2x Ø200	1 050	1 700	1/4"-5/8"	< 3,5	90+24	37
BSF-NG-3 075	2 1/2	230 V-I*	1 755	14	2 450	27	3 080	48	2,3	26,3	3x Ø254	1 725	1 700	1/4"-5/8"	< 3,5	90+45	37
BSF-NG-4 096	3 1/2	400 V-III	2 139	19	2 670	39	3 523	68	2,48	12,0	3x Ø254	1 725	3 700	3/8"-3/4"	< 4,5	97+45	39
BSF-NG-4 108	4 1/4	400 V-III	2 463	29	3 276	50	4 118	78	2,82	14,6	3x Ø254	1 725	3 700	3/8"-7/8"	< 5,0	97+45	37
BSF-NG-4 136	5	400 V-III	2 949	37	3 775	61	4 648	100	3,64	16,8	3x Ø254	1 725	3 700	3/8"-7/8"	< 5,0	100+45	32

Opcionales

- Cambio a alimentación 400 V-III-50 Hz.
- Control de condensación proporcional por variación de velocidad (excepto serie 0).
- Rejilla exterior de protección de la batería.
- Separador de aceite.
- Recubrimiento anticorrosión de batería evaporador.
- Recubrimiento anticorrosión de batería condensador.
- Mando multifunción de mayor tamaño.

Dimensiones Evaporador

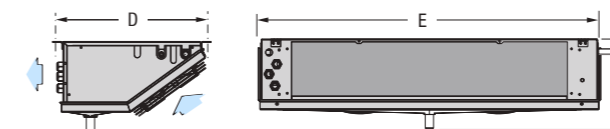

Dimensiones Condensador

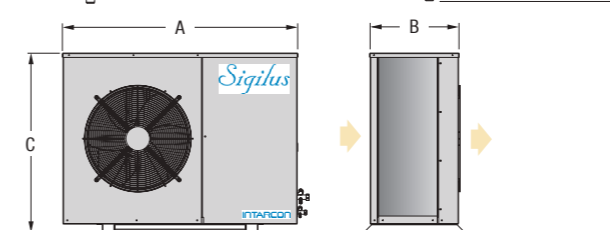

⁽¹⁾ Las prestaciones nominales están referidas al funcionamiento con temperatura de cámara de 0°C (MT) y -20°C (BT), y temperatura exterior de 35°C. Volumen de cámara estimado según condiciones de las bases de cálculo

⁽²⁾ Nivel sonoro referido a nivel de presión acústica en dB(A), medido en campo abierto a 10 m de distancia de la fuente.

* Unidades disponibles en tensión 400 V-III -50 Hz.

Dimensiones (mm)	A	B	C	D	E	F	Ventiladores evaporador
series 0 y 00	670	308	450	417	549	185	1x Ø 172
series 1 y 11	1 030	375	580	430	643	235	1x Ø 200
series 2 y 12	1 030	375	580	430	993	235	2x Ø 200
series 3 y 13	1 030	375	580	508	1 691	235	3x Ø 254
series 4 y 23	1 080	415	830	508	1 691	235	3x Ø 254
serie 24	1 080	415	830	547	2 064	285	4x Ø 300
serie 34	1 150	480	1 100	547	2 064	285	4x Ø 300

230 V-I-50 Hz* / 400 V-III-50 Hz | Media temperatura | R134a / R449A

SERIE / MODELO	COMPRESOR		POTENCIA FRIGORÍFICA / VOLUMEN CÁMARA, SEGÚN TEMPERATURA DE CÁMARA (1)								POTENCIA ABSORB. NOMINAL (kW)	INTENS. MÁXIMA ABSORB. (A)	VENT. EVAP.	CAUDAL EVAP. (m³/h)	CAUDAL COND. (m³/h)	CONEXIÓN FRIGORÍFICA LIQ.-GAS	CARGA REFRIG. (kg)	PESO (kg)	NIVEL PRESIÓN SONORA dB(A) (2)
	CV	TENSIÓN	-5°C		0°C		5°C		10°C										
			W	m³	W	m³	W	m³	W	m³									
MSF-QY-10 068	3 1/2	400 V-III	3 281	42	4 106	60	4 998	69	5 985	110	1,98	12,8	1x Ø350	2 100	3 200	1/4"-3/4"	< 4,0	82+43	25
MSF-QY-20 086	4	400 V-III	3 523	45	4 442	65	5 429	75	6 515	120	2,19	14,8	1x Ø350	2 100	3 700	3/8"-7/8"	< 4,5	96+43	38
MSF-QY-21 108	5	400 V-III	4 226	58	5 334	81	6 521	130	7 807	210	2,56	16,3	1x Ø350	2 700	3 700	3/8"-7/8"	< 5,0	98+56	35
MSF-QY-22 136	6 1/2	400 V-III	5 749	80	7 277	120	8 831	186	10 553	290	3,63	21,1	2x Ø350	4 150	3 700	3/8"-1 1/8"	< 5,0	101+72	34
MSF-QY-33 171	8	400 V-III	6 746	100	8 484	172	10 295	197	12 306	354	4,42	24,1	2x Ø350	5 200	4 000	3/8"-1 1/8"	< 7,0	140+89	40
MSF-QY-33 215	10	400 V-III	8 426	130	10 563	241	12 857	268	15 419	440	5,24	30,5	3x Ø350	6 200	6 500	3/8"-1 1/8"	< 7,5	147+94	39
MSF-QY-34 271	13	400 V-III	11 099	165	13 776	256	16 622	346	19 777	550	7,19	40,2	4x Ø350	8 300	6 500	1/2"-1 3/8"	< 8,5	152+118	38
MSF-QG-10 038	1 3/4	400 V-III	3 280	31	3 919	48	4 625	75	5 472	120	1,77	7,4	1x Ø350	2 100	3 200	1/4"-5/8"	< 3,0	82+43	29
MSF-QG-20 048	2	400 V-III	3 964	43	4 736	63	5 572	95	6 605	150	2,21	8,8	1x Ø350	2 100	3 700	3/8"-3/4"	< 5,0	84+43	26
MSF-QG-20 054	2 1/4	400 V-III	4 395	48	5 197	72	6 078	110	7 158	170	2,38	9,4	1x Ø350	2 100	3 700	3/8"-3/4"	< 5,0	85+43	26
MSF-QG-21 060	3	400 V-III	5 081	61	6 032	89	7 055	130	8 328	200	2,84	10,4	1x Ø350	2 700	3 700	3/8"-3/4"	< 5,0	88+56	26
MSF-QG-21 068	3 1/2	400 V-III	5 519	78	6 528	110	7 601	160	8 942	250	3,21	11,4	1x Ø350	2 700	3 700	3/8"-3/4"	< 5,0	88+56	25
MSF-QG-32 086	4	400 V-III	6 787	91	8 180	130	9 707	190	11 545	300	4,13	13,6	2x Ø350	4 150	4 000	1/2"-7/8"	< 7,0	115+72	38
MSF-QG-32 108	5	400 V-III	8 623	125	10 181	175	11 880	255	13 969	400	5,05	16,7	2x Ø350	4 150	6 500	1/2"-7/8"	< 7,0	120+72	35
MSF-QG-43 136	6 1/2	400 V-III	11 105	160	13 146	220	15 399	320	18 145	500	6,63	21,5	3x Ø350	6 200	7 000	1/2"-1 1/8"	< 10,0	135+89	34
MSF-QG-44 160	8	400 V-III	11 597	170	14 009	230	16 660	340	19 806	530	7,59	26,0	4x Ø350	8 300	7 000	5/8"-1 1/8"	< 10,0	157+118	40

230 V-I-50 Hz* / 400 V-III-50 Hz | Baja temperatura | R449A

SERIE / MODELO	COMPRESOR		POTENCIA FRIGORÍFICA / VOLUMEN CÁMARA, SEGÚN TEMPERATURA DE CÁMARA (1)						POTENCIA ABSORB. NOMINAL (kW)	INTENS. MÁXIMA ABSORB. (A)	VENT. EVAP.	CAUDAL EVAP. (m³/h)	CAUDAL COND. (m³/h)	CONEXIÓN FRIGORÍFICA LIQ.-GAS	CARGA REFRIG. (kg)	PESO (kg)	NIVEL PRESIÓN SONORA dB(A) (2)
	CV	TENSIÓN	-25°C		-20°C		-15°C										
			W	m³	W	m³	W	m³									
BSF-QG-10 075	2 1/2	230 V-I *	1 760	14	2 465	27	3 110	48	2,3	25,1	1x Ø350	2 100	1 700	1/4"-5/8"	< 3	85+43	37
BSF-QG-20 096	3 1/2	400 V-III	2 456	20	3 135	43	3 881	74	2,39	11,5	1x Ø350	2 100	3 700	1/4"-3/4"	< 4,0	97+43	39
BSF-QG-21 108	4 1/4	400 V-III	3 023	28	3 883	50	4 772	86	2,76	13,5	1x Ø350	2 700	3 700	1/4"-7/8"	< 5,0	97+56	37
BSF-QG-22 136	5	400 V-III	4 159	53	5 116	83	6 146	130	4,02	16,4	2x Ø350	5 200	3 700	3/8"-1 1/8"	< 5,0	97+72	32
BSF-QG-33 215	7 1/2	400 V-III	5 970	80	7 605	130	9 334	200	5,63	25,8	3x Ø350	6 200	6 500	1/2"-1 1/8"	< 7,5	147+94	39
BSF-QG-34 271	10	400 V-III	8 005	120	9 839	185	11 798	230	7,15	28,2	4x Ø350	8 300	6 500	1/2"-1 3/8"	< 8,5	147+118	39

Opcionales

- Cambio a alimentación 400 V-III-50 Hz.
- Rejilla exterior de protección de la batería.
- Separador de aceite.
- Recubrimiento anticorrosión de batería evaporador.
- Recubrimiento anticorrosión de batería condensador.
- Mando multifunción de mayor tamaño.

Dimensiones Evaporador

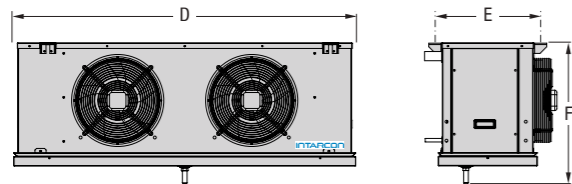

Dimensiones Condensador

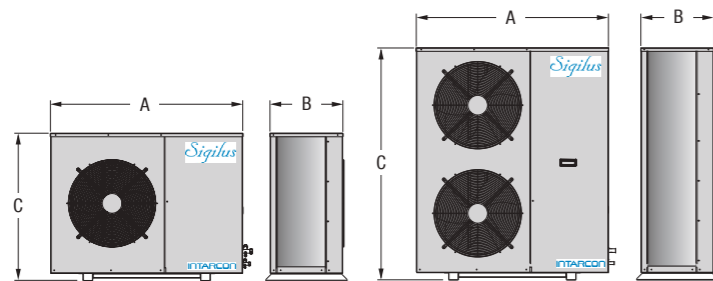

(1) Las prestaciones nominales están referidas al funcionamiento con temperatura de cámara de 0°C (MT) y -20°C (BT), y temperatura exterior de 35°C. Volumen de cámara estimado según condiciones de las bases de cálculo (pág. VI).

(2) Nivel sonoro referido a nivel de presión acústica en dB(A), medido en campo abierto a 10 m de distancia de la fuente. * Unidades disponibles en tensión 400 V-III-50 Hz.

Dimensiones (mm)	A	B	C	D	E	F
serie 10	1 030	375	580	880	455	581
serie 20	1 080	415	830	880	455	581
serie 21	1 080	415	830	1 230	455	581
serie 22	1 080	415	830	1 530	455	581
serie 32	1 150	480	1 100	1 530	455	581
serie 33	1 150	480	1 100	1 930	455	581
serie 34	1 150	480	1 100	2 430	455	581
serie 43	1 150	480	1 350	1 930	455	581
serie 44	1 150	480	1 350	2 430	455	581

230 V-I-50 Hz* / 400 V-III-50 Hz | Alta temperatura | R134a / R449A

SERIE / MODELO	COMPRESOR		POTENCIA FRIGORÍFICA / VOLUMEN CÁMARA, SEGÚN TEMPERATURA DE CÁMARA (1)						POTENCIA ABSORB. NOMINAL (kW)	INTENS. MÁXIMA ABSORB. (A)	CAUDAL EVAP. (m³/h)	CAUDAL COND. (m³/h)	CONEXIÓN FRIGORÍFICA LIQ.-GAS	CARGA REFRIG. (kg)	PESO (kg)	NIVEL PRESIÓN SONORA dB(A) (2)
	CV	TENSIÓN	+9°C		+12°C		+15°C									
			W	m³	W	m³	W	m³								
ASF-DY-11 015	1/2	230 V-I	1 687	16	1 922	21	2 160	29	0,69	4,7	1 100	1 700	1/4"-1/2"	< 2,5	57+32	34
ASF-DY-11 026	3/4	230 V-I	2 342	23	2 678	30	2 977	41	1,05	8,4	1 100	1 700	1/4"-1/2"	< 2,5	65+32	34
ASF-DY-12 033	1	230 V-I	2 840	27	3 176	36	3 533	48	1,33	10,4	1 800	1 700	1/4"-5/8"	< 3,0	67+45	34
ASF-DY-13 053	1 1/2	230 V-I *	4 226	42	4 730	56	5 271	72	2,04	13,6	3 150	1 700	3/8"-3/4"	< 4,0	77+65	35
ASF-DY-13 074	2	230 V-I *	6 053	62	6 825	83	7 634	112	2,61	17,6	3 150	3 200	3/8"-3/4"	< 4,5	79+65	34
ASF-DY-23 086	4	400 V-III	7 151	75	8 033	99	8 957	131	2,90	14,4	3 150	3 700	3/8"-7/8"	< 5,0	96+65	38
ASF-DY-24 108	5	400 V-III	8 936	99	10 028	122	11 146	165	3,80	17,5	5 700	3 700	3/8"-7/8"	< 5,0	98+70	35
ASF-DY-24 136	6 1/2	400 V-III	11 093	128	12 332	168	13 645	224	5,00	21,2	5 700	3 700	1/2"-1 1/8"	< 6,0	98+70	34
ASF-DY-34 171	8	400 V-III	13 424	146	14 989	186	16 669	251	5,88	25,2	5 700	6 500	1/2"-1 1/8"	< 6,0	120+70	40
ASF-DY-44 215	10	400 V-III	15 771	171	17 593	218	19 546	294	6,61	30,2	5 700	7 000	1/2"-1 3/8"	< 9,5	120+70	39
ASF-DG-1 016	5/8	230 V-I	2 161	19	2 387	25	2 635	35	0,99	7,5	1 100	1 700	1/4"-1/2"	< 2,5	67+32	38
ASF-DG-1 018	3/4	230 V-I	2 462	23	2 709	30	2 961	42	1,18	8,8	1 100	1 700	1/4"-1/2"	< 2,5	68+32	35
ASF-DG-1 024	1	230 V-I	3 225	29	3 539	39	3 879	51	1,53	11,3	1 800	1 700	3/8"-5/8"	< 3,5	82+45	34
ASF-DG-1 026	1 1/4	230 V-I *	3 709	35	4 078	46	4 466	63	1,75	12,0	1 800	3 200	3/8"-5/8"	< 3,5	83+45	40
ASF-DG-1 034	1 1/2	230 V-I *	4 607	43	5 046	58	5 494	77	2,24	16,6	1 800	3 200	3/8"-5/8"	< 3,5	83+45	39
ASF-DG-1 038	1 3/4	400 V-III	5 393	52	5 885	68	6 410	91	2,20	7,8	3 150	3 200	3/8"-5/8"	< 4,0	82+65	29
ASF-DG-2 048	2	400 V-III	6 722	67	7 343	87	7 962	115	2,76	9,3	3 150	3 700	1/2"-3/4"	< 5,5	84+65	26
ASF-DG-2 054	2 1/2	400 V-III	7 447	75	8 113	97	8 793	130	3,00	9,8	3 150	3 700	1/2"-3/4"	< 5,5	85+65	26
ASF-DG-3 060	3	400 V-III	8 824	94	9 673	115	10 551	155	3,60	11,9	3 150	6 500	1/2"-7/8"	< 6,0	88+65	26
ASF-DG-3 068	3 1/2	400 V-III	9 662	98	10 578	125	11 512	165	4,19	12,9	3 150	6 500	1/2"-7/8"	< 6,0	88+65	25
ASF-DG-4 086	4	400 V-III	11 687	120	12 829	155	14 001	205	4,90	15,2	5 700	7 000	5/8"-1 1/8"	< 9,0	115+70	38
ASF-DG-4 108	5	400 V-III	14 416	150	15 702	190	17 068	255	6,40	18,2	5 700	7 000	5/8"-1 1/8"	< 8,5	120+70	35

Opcionales

- Cambio a alimentación 400 V-III-50 Hz.
- Control de condensación proporcional por variación de velocidad (ya incluido en serie 2/23 y superiores).
- Rejilla exterior de protección de la batería.
- Separador de aceite.
- Recubrimiento anticorrosión de batería evaporador.
- Recubrimiento anticorrosión de batería condensador.
- Bomba de condensados.
- Mando multifunción de mayor tamaño.

(1) Las prestaciones nominales están referidas al funcionamiento con temperatura de cámara de 12°C (AT) y temperatura exterior de 35°C. Volumen de sala estimado según condiciones de las bases de cálculo (pág. VI).

(2) Nivel sonoro referido a nivel de presión acústica en dB(A), medido en campo abierto a 10 m de distancia de la fuente.

* Unidades disponibles en tensión 400 V-III-50 Hz.

Dimensiones Evaporador

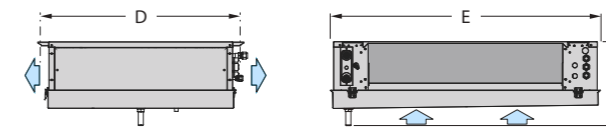

Dimensiones Condensador

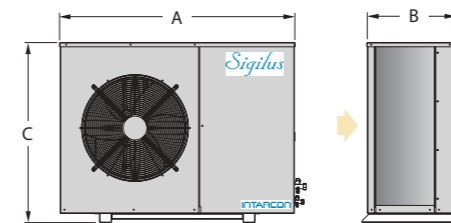

Dimensiones (mm)	A	B	C	D	E	F	Ventiladores evaporador
serie 11	1 030	375	580	798	736	310	1x Ø 360
serie 12	1 030	375	580	798	1 086	310	2x Ø 360
serie 13	1 030	375	580	798	1 786	310	3x Ø 360
serie 23	1 080	415	830	798	1 786	310	3x Ø 360
serie 24	1 080	415	830	888	2 186	360	3x Ø 450
serie 34	1 150	480	1 100	888	2 186	360	3x Ø 450
serie 44	1 150	480	1 350	888	2 186	360	3x Ø 450
ASF-DG-1 016 y 1 018	1 030	375	580	798	736	310	1x Ø 360
ASF-DG-1 024 a 1 034	1 030	375	580	798	1 086	310	2x Ø 360



Descripción Equipos semicompactos de refrigeración a media temperatura formados por una unidad motocondensadora en versión silenciosa, horizontal o centrífuga, y una unidad evaporadora de tipo plafón

- Características**
- Alimentación 230 V-I-50 Hz o 400 V-III-50 Hz. Disponible en 60Hz.
 - Carga de refrigerante R-134a o R-449A reducida.
 - Compresor hermético alternativo.
 - Evaporador de plafón de doble flujo de aire con ventiladores axiales regulados a muy baja velocidad.
 - Presostatos de alta y baja presión.
 - Válvula solenoide.
 - Expansión por válvula termostática.
 - Desescarche por resistencias eléctricas.
 - Bandeja de condensados en acero inoxidable.
 - Conexiones de tipo Flare (hasta 1/2"-3/4") y válvulas de servicio.
 - Protección magnetotérmica.
 - Recipiente de líquido.
 - Precarga de refrigerante para hasta 10 m de tubería.
 - Regulación electrónica multifunción con mando a distancia y control de condensación digital.

Versión MSF-U Equipos compuestos por una unidad motocondensadora silenciosa, y una unidad evaporadora quasiestática de tipo plafón.

Versión MSH-CU Equipos compuestos por una unidad motocondensadora centrífuga y una unidad evaporadora quasiestática de tipo plafón.

Esquema de instalación

Distancia vertical máxima entre unidades de 15 m en caso de que la unidad condensadora esté situada a mayor altura que la unidad evaporadora, y de 6 m en caso contrario.

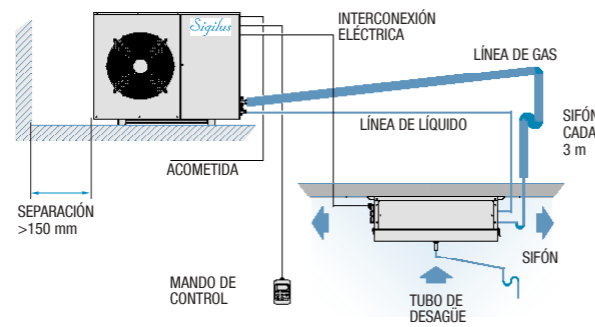

- ✳ Evaporador de doble flujo a muy baja velocidad, especialmente diseñado para conservación de carne.
- ✳ Equipos certificados en fábrica sin necesidad de ensayos in situ. (Reglamento Seguridad de Instalaciones Frigoríficas).
- ✳ Precarga de refrigerante incluida.
- ✳ Equipos exentos de control de fugas.

Conservación de carne

Los equipos quasiestáticos, gracias a la configuración de sus unidades evaporadoras, están especialmente indicados para cámaras de conservación de carne en el entorno de los 0 °C.

Los evaporadores de doble flujo de aire incorporan ventiladores ajustados a una mínima velocidad de giro para simular la circulación de aire por convección natural al igual que un evaporador de tipo estático.

De este modo se obtiene una mínima velocidad de aire para evitar la pérdida de humedad del producto, a la vez que se mantiene una adecuada humedad relativa en el interior de la cámara para evitar la proliferación bacteriana en la superficie del producto.



Maduración de carne (opcional)

La maduración de carne requiere el control de la humedad relativa de la cámara en un rango determinado.

Los equipos para la maduración de carne, están configurados para cámaras en el entorno de los 0 °C y humedad relativa en el rango del 40 % al 95 %.

Estos equipos incorporan una avanzada regulación electrónica para el control de la temperatura y humedad en el interior de la cámara, con funciones de deshumidificación y humidificación a vapor de 3 kg/h de capacidad, compuesto por: lanzas de vapor integradas en la unidad evaporadora, un cilindro generador de electrodos sumergidos con válvulas de alimentación y purga de agua, y controlador electrónico de la humedad relativa en la cámara.



Resistencia de cárter

De serie en todos los equipos Sigilus MSF y opcional en series MSH. Se recomienda su inclusión en equipos instalados en intemperie.

230 V-I-50 Hz* / 400 V-III-50 Hz | Media temperatura - Quasiestático | R134a / R449A

series MSF-U / MSH-CU

SERIE/MODELO	COMPRESOR		POTENCIA FRIGORÍFICA / VOLUMEN CÁMARA, SEGÚN TEMPERATURA DE CÁMARA (1)								POTENCIA ABSORB. NOMINAL (kW)	INTENS. MÁXIMA ABSORB. (A)	CAUDAL EVAP. (m³/h)	CAUDAL COND. (m³/h)	CONEXIÓN FRIGORÍFICA LIQ.-GAS	CARGA REFRIG. (kg)	PESO (kg)	NIVEL PRESIÓN SONORA dB(A) (2)
	CV	TENSIÓN	-5°C		+0°C		+5°C		+10°C									
			W	m³	W	m³	W	m³	W	m³								
MSF-UY-11 026	3/4	230 V-I	1 145	7,6	1 449	15	1 785	24	2 153	41	0,83	9,4	600	1 700	1/4"-1/2"	< 2,0	65+32	34
MSF-UY-12 033	1	230 V-I	1 428	12	1 764	20	2 147	34	2 562	53	0,96	10,0	700	1 700	1/4"-5/8"	< 3,0	67+45	34
MSF-UY-13 053	1 1/2	230 V-I *	2 100	22	2 657	40	3 255	56	3 938	86	1,50	12,6	1 325	1 700	1/4"-3/4"	< 3,5	77+65	35
MSF-UY-13 074	2	230 V-I *	2 741	30	3 434	48	4 190	74	5 009	120	1,86	16,9	1 325	1 700	1/4"-3/4"	< 4,5	79+65	37
MSF-UY-23 086	4	400 V-III	3 308	40	4 158	62	5 114	99	6 132	154	2,08	13,4	1 325	3 700	3/8"-7/8"	< 5,5	96+65	38
MSF-UY-24 108	5	400 V-III	4 431	54	5 576	87	6 825	134	8 243	209	2,74	16,9	2 600	3 700	3/8"-7/8"	< 7,5	98+65	38
MSF-UY-24 136	6 1/2	400 V-III	5 444	72	6 815	108	8 306	162	10 038	268	3,44	20,9	2 600	3 700	3/8"-1 1/8"	< 7,5	101+65	34
MSF-UY-34 171	8	400 V-III	11 151	153	7 539	123	9 293	181	11 146	299	4,06	23,9	2 600	4 000	3/8"-1 1/8"	< 8,0	140+65	40
MSF-UG-1 016	5/8	230 V-I	1 215	9,5	1 483	15	1 772	25	2 101	40	0,89	7,5	600	1 700	1/4"-1/2"	< 2,5	67+32	34
MSF-UG-1 018	3/4	230 V-I	1 421	12	1 720	19	2 050	30	2 410	48	1,03	8,8	600	1 700	1/4"-1/2"	< 2,5	68+32	34
MSF-UG-1 024	1	230 V-I	1 648	15	1 998	24	2 390	37	2 812	59	1,19	11,0	700	1 700	3/8"-5/8"	< 3,5	82+43	34
MSF-UG-1 034	1 1/2	230 V-I *	2 235	23	2 699	35	3 193	54	3 739	84	1,84	16,0	700	1 700	3/8"-5/8"	< 3,5	83+43	35
MSF-UG-1 038	1 3/4	400 V-III	2 833	31	3 451	47	4 130	72	4 882	115	1,85	7,4	1 325	3 200	3/8"-5/8"	< 4,5	82+63	29
MSF-UG-2 054	2 1/2	400 V-III	3 784	47	4 600	70	5 447	105	6 426	160	2,38	9,4	1 325	3 700	3/8"-3/4"	< 5,5	85+63	26
MSF-UG-2 068	3 1/2	400 V-III	4 825	64	5 794	93	6 834	135	8 017	205	3,35	11,4	1 325	3 700	1/2"-3/4"	< 7,0	88+63	25
MSF-UG-3 086	4	400 V-III	6 027	83	7 257	120	8 579	175	10 060	270	4,23	13,9	2 600	4 000	1/2"-7/8"	< 7,0	115+66	38

(1) Las prestaciones nominales están referidas al funcionamiento con temperatura de cámara de 0°C y temperatura exterior de 35°C. Volumen de cámara estimado según condiciones de las bases de cálculo (pág. VI).

(2) Nivel sonoro referido a nivel de presión acústica en dB(A), medido en campo abierto a 10 m de distancia de la fuente.

* Unidades disponibles en tensión 400 V-III-50 Hz.

Opcionales

- Cambio a alimentación 400 V-III-50 Hz.
- Control de condensación proporcional por variación de velocidad (incluido en serie MSF 2/23 y superiores).
- Rejilla exterior de protección de la batería.
- Separador de aceite.
- Tratamiento anticorrosión en poliuretano de batería de condensación.
- Control para maduración de carne con funciones de humidificación y deshumidificación. Display táctil VTIIPG.

Consultar Consultar

(1) Las prestaciones nominales están referidas al funcionamiento con temperatura de cámara de 0 °C y temperatura exterior de 35 °C. Volumen de cámara estimado según condiciones de las bases de cálculo (pág. 8).

(2) Equipos con carga inferior a 5 toneladas de CO₂ equivalente (3,5 kg de R-134a o R-449A) exentos de comprobación de fugas (RD 552/2019).

(3) Nivel sonoro referido a nivel de presión acústica en dB(A), medido en campo abierto a 10 m de distancia de la fuente.

* Unidades disponibles en tensión 400 V-III-50 Hz.

Dimensiones Evaporador

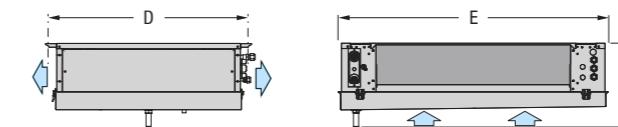

Dimensiones Condensador

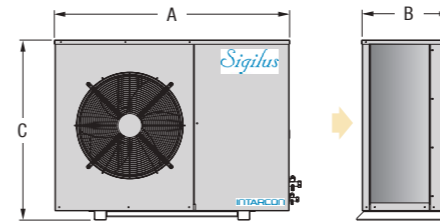

Dimensiones (mm)	A	B	C	D	E	F	Ventiladores evaporador
serie 11	1 030	373	577	798	706	245	1x Ø 360
serie 12	1 030	373	577	798	1 056	245	1x Ø 360
serie 13	1 030	373	577	798	1 756	245	2x Ø 360
serie 23	1 080	410	827	798	1 756	245	2x Ø 360
serie 24	1 080	410	827	888	2 156	295	2x Ø 450
serie 34	1 150	481	1 097	888	2 156	295	2x Ø 450
MSF-UG-1 016 y 1 018	1 030	373	577	798	706	245	1x Ø 360
MSF-UG-1 024 y 1 034	1 030	373	577	798	1 056	245	1x Ø 360
MSF-UG-1 038	1 030	373	577	798	1 756	245	2x Ø 360
MSF-UG-2 054 y 2 068	1 080	410	827	798	1 756	245	2x Ø 360
MSF-UG-3 086	1 150	481	1 097	888	2 156	295	2x Ø 450

Versión centrífuga, serie MSH-CU

Los equipos quasiestáticos se encuentran también disponibles en versión con condensadora centrífuga.

SERIE/MODELO	CV	P. FRIGORÍFICA	
		0°C	35°C
MSH-CUY-11 026	3/4	1 281	12
MSH-CUY-11 033	1	1 811	15
MSH-CUY-22 033	1	1 811	22
MSH-CUY-22 053	1 1/2	2 174	28
MSH-CUY-33 053	1 1/2	2 657	35
MSH-CUY-33 074	2	3 402	47
MSH-CUY-43 086	4	4 153	70
MSH-CUY-43 108	5	5 219	84
MSH-CUY-44 108	5	5 555	89
MSH-CUY-44 136	6 1/2	6 773	108
MSH-CUG-1 016	5/8	1 349	13
MSH-CUG-1 018	3/4	1 545	16
MSH-CUG-2 024	1	1 978	23
MSH-CUG-2 034	1 1/2	2 627	34
MSH-CUG-3 038	1 3/4	3 265	44
MSH-CUG-4 054	2 1/4	4 590	69
MSH-CUG-4 086	3 1/2	5 783	93



- ❖ Evaporador de tipo plafón de doble flujo, dimensionado para aplicaciones de alta humedad relativa.
- ❖ Control pasivo de humedad (regulación entre 60 % y 95 %)*.
- ❖ Equipos certificados en fábrica sin necesidad de ensayos in situ. (Reglamento Seguridad de Instalaciones Frigoríficas).
- ❖ Precarga de refrigerante incluida.
- ❖ Equipos exentos de control de fugas.

Conservación a humedad relativa controlada

La conservación de ciertos productos, tales como frutas, verduras o flor cortada, requiere el control de la humedad relativa en la cámara dentro de un rango determinado.

Estos equipos ajustados para alta humedad relativa están especialmente indicados para cámaras de conservación de productos hortofrutícolas.

Los evaporadores cuentan con una doble impulsión de aire a través de baterías sobredimensionadas para poder obtener hasta un alto nivel de humedad relativa en el interior de la cámara en torno al 95%, evitando así la pérdida de humedad y de peso del producto.

Control electrónico de temperatura y humedad

Los equipos incorporan una avanzada regulación electrónica para el control de la temperatura y humedad en el interior de la cámara.

- Mando multifunción de control digital a distancia con visualización de la temperatura y humedad relativa.
- Control de humedad relativa en el rango de regulación del 60% al 95%*.
- Opcionalmente se integran kits de humidificación activa con lanzas de vapor y kits de deshumectación y estufaje.

* La regulación de humedad en la cámara se realiza de forma pasiva, actuando sobre el caudal de ventilación del evaporador, sin aporte de vapor de agua. El rango real de regulación de humedad depende en gran medida de las condiciones de la cámara, humedad absoluta exterior y tipo de producto.

Interconexiones eléctricas

Para la interconexión de las unidades condensadora y evaporadora se han de prever las siguientes secciones de cable para 10 m de longitud.

Tensión	230 V-I-50 Hz	400 V-III-50 Hz
Sondas	4 x 1 mm ²	
Maniobra	3 x 1 mm ² + T	5 x 1 mm ² + T
Mando	2 x 1 mm ²	

Para conocer interconexiones eléctricas de cada modelo, ver manual técnico.

230 V-I-50 Hz* / 400 V-III-50 Hz | Media temperatura - Control de humedad | R134a / R449A

serie HSF-D / HSH-CD

SERIE / MODELO	COMPRESOR		POTENCIA FRIGORÍFICA / VOLUMEN CÁMARA, SEGÚN TEMPERATURA DE CÁMARA ⁽¹⁾						POTENCIA ABSORB. NOMINAL (KW)	INTENS. MÁXIMA ABSORB. (A)	CAUDAL EVAP. (m ³ /h)	CAUDAL COND. (m ³ /h)	CONEXIÓN FRIGORÍFICA LIQ.-GAS	CARGA REFRIG. (kg)	PESO (kg)	NIVEL PRESIÓN SONORA dB(A) ⁽²⁾	
	CV	TENSIÓN	0 °C HR 95%		5 °C HR 95%		10 °C HR 95%										
			W	m ³	W	m ³	W	m ³									
R134a	HSF-DY-12 015	1/2	230 V-I	1 220	13	1 544	22	1 906	38	0,74	6,5	1 800	1 700	1/4"-1/2"	<2,0	57+32	34
	HSF-DY-12 026	3/4	230 V-I	1 701	19	2 116	32	2 594	53	1,06	10,2	1 800	1 700	1/4"-1/2"	<2,0	65+32	34
	HSF-DY-13 033	1	230 V-I	2 105	25	2 620	43	3 192	73	1,30	11,0	3 150	1 700	1/4"-1/2"	<2,5	67+45	34
	HSF-DY-13 053	1 1/2	230 V-I *	2 814	37	3 486	64	4 237	103	1,90	13,6	3 150	1 700	1/4"-5/8"	<3,0	77+65	35
	HSF-DY-14 074	2	230 V-I *	3 980	57	4 977	91	6 090	148	2,57	17,7	5 700	1 700	1/4"-3/4"	<5,0	79+65	37
	HSF-DY-24 086	4	400 V-III	5 465	56	6 773	134	8 311	217	2,87	14,5	5 700	3 700	3/8"-7/8"	<6,0	96+65	38
	HSF-DY-24 108	5	400 V-III	6 389	102	7 865	158	9 713	263	3,40	17,5	5 700	3 700	3/8"-7/8"	<6,0	98+65	35
HSF-DY-24 136	6 1/2	400 V-III	7 985	136	9 870	202	11 960	331	4,44	21,5	5 700	3 700	3/8"-1 1/8"	<6,5	101+70	34	
R449A	HSF-DG-1 014	1/2	230 V-I	1 530	15	1 801	25	2 112	41	0,85	6,6	1 100	1 700	1/4"-1/2"	<2,0	59+32	34
	HSF-DG-1 016	5/8	230 V-I	1 708	18	2 015	29	2 378	47	0,93	7,5	1 100	1 700	1/4"-1/2"	<2,0	67+32	34
	HSF-DG-1 018	3/4	230 V-I	2 162	24	2 582	38	3 036	62	1,22	9,1	1 800	1 700	1/4"-1/2"	<2,0	68+45	34
	HSF-DG-1 024	1	230 V-I	2 461	30	2 945	46	3 478	75	1,40	11,3	1 800	1 700	3/8"-5/8"	<3,5	82+45	34
	HSF-DG-1 026	1 1/4	230 V-I *	2 798	35	3 289	54	3 849	86	1,53	16,3	1 800	1 700	3/8"-5/8"	<3,5	83+45	34
	HSF-DG-1 034	1 1/2	230 V-I *	3 188	43	3 734	64	4 361	100	2,09	5,9	1 800	1 700	3/8"-5/8"	<3,5	83+45	35
	HSF-DG-1 038	1 3/4	400 V-III	4 130	55	4 905	85	5 760	135	2,02	7,8	3 150	3 200	3/8"-5/8"	<4,0	82+65	29
	HSF-DG-2 048	2	400 V-III	5 250	76	6 170	115	7 244	175	2,53	7,9	3 150	3 700	3/8"-3/4"	<5,0	84+65	26
	HSF-DG-2 054	2 1/2	400 V-III	5 881	87	6 852	130	7 997	200	2,77	9,8	3 150	3 700	3/8"-3/4"	<5,0	85+65	26
	HSF-DG-2 060	3	400 V-III	6 728	100	7 844	150	9 122	230	3,28	11,3	3 800	3 700	3/8"-3/4"	<5,0	88+65	26
	HSF-DG-2 068	3 1/2	400 V-III	7 399	115	8 576	165	9 934	260	3,77	12,3	3 800	3 700	1/2"-3/4"	<5,0	88+65	25
	HSF-DG-3 086	4	400 V-III	8 722	140	10 308	200	12 124	320	4,74	14,5	5 700	4 000	1/2"-7/8"	<9,0	115+70	38

Descripción

Equipos semicompactos de refrigeración con control de humedad, constituidos por una unidad motocondensadora silenciosa, o centrífuga, y una unidad evaporadora de tipo plafón con doble flujo de aire, dimensionada para aplicaciones con alta humedad relativa.

Características

- Alimentación 230 V-I-50 Hz o 400 V-III-50 Hz. Disponible en 60Hz.
- Carga de refrigerante R-134a o R-449A reducida.
- Compresor hermético alternativo.
- Presostatos de alta y baja presión.
- Evaporador de plafón con doble flujo de aire dimensionado para una regulación de humedad relativa del 60 % al 95 %*.
- Válvula solenoide y válvula de expansión termostática integradas en el evaporador.
- Desescarche por aire.
- Bandeja de condensados en acero inoxidable.
- Conexiones de tipo Flare (hasta 1/2"-3/4") y válvulas de servicio.
- Protección magnetotérmica.
- Recipiente de líquido.
- Precarga de refrigerante para hasta 10 m de tubería.
- Regulación electrónica multifunción con control de temperatura y humedad y mando a distancia.

Versión HSF-D

Equipos compuestos por una unidad motocondensadora silenciosa y una unidad evaporadora de doble flujo de alta humedad relativa.

Versión HSH-CD

Equipos compuestos por una unidad motocondensadora centrífuga y una unidad evaporadora de doble flujo de alta humedad relativa

Esquema de instalación

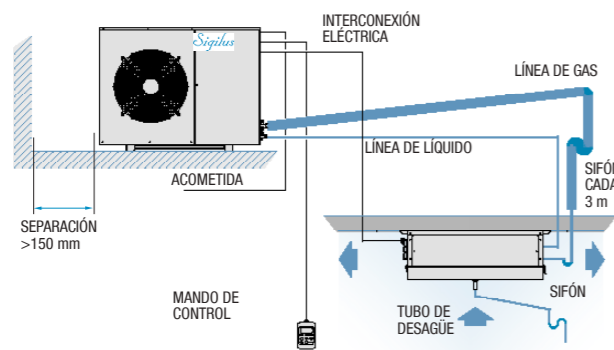

Opcionales

- Control de condensación proporcional por variación de velocidad (incluido en HSF serie 2/22 y superiores).
- Cambio a alimentación 400 V-III-50 Hz. *
- Rejilla exterior de protección de la batería.
- Kit de humidificación activa integrado.
- Kit de deshumectación y estufaje.
- Otros refrigerantes.

Consultar
Consultar
Consultar

Dimensiones Evaporador

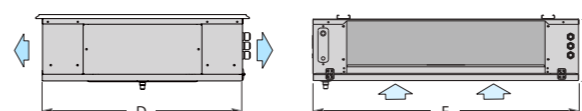

Dimensiones Condensador

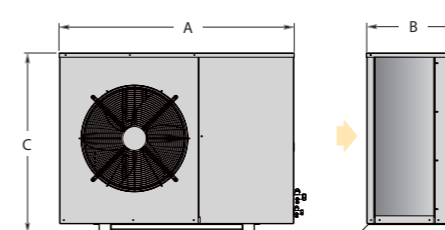

Dimensiones (mm)		A	B	C	D	E	F	Ventiladores evaporador
R134a	serie 12	1030	373	577	762	1056	250	2x Ø 360
	serie 13	1030	373	577	762	1756	250	3x Ø 360
	serie 14	1030	373	577	852	2156	250	3x Ø 450
	serie 24	1080	410	827	852	2156	300	3x Ø 450
R449A	HSF-DG-1014 y 1016	1030	373	577	762	706	250	1x Ø 360
	HSF-DG-1018 a 1034	1030	373	577	762	1056	250	2x Ø 360
	HSF-DG-1038	1030	373	577	762	1756	250	3x Ø 360
	HSF-DG-2048 a 2068	1080	410	827	762	1756	250	3x Ø 360
	HSF-DG-3086	1150	481	1097	852	2156	300	3x Ø 450

⁽¹⁾ Las prestaciones nominales están referidas al funcionamiento con temperatura de cámara de 5°C, humedad relativa de cámara del 95% y temperatura exterior de 35°C. Volumen de cámara estimado según condiciones de las bases de cálculo

⁽²⁾ Nivel sonoro referido a nivel de presión acústica en dB(A), medido en campo abierto a 10 m de distancia de la fuente.

* Unidades disponibles en tensión 400 V-III-50 Hz.

Versión centrífuga, serie HSH-CD

Los equipos con control de humedad relativa se encuentran también disponibles en versión con condensadora centrífuga.

SERIE / MODELO	CV	P. FRIGORÍFICA		
		5 °C HR 95	W	m ³
R134a	HSH-CDY-12 015	1/2	1415	21
	HSH-CDY-12 026	3/4	1 859	28
	HSH-CDY-12 033	1	2 242	32
	HSH-CDY-23 033	1	2 746	45
	HSH-CDY-23 053	1 1/2	3 507	64
	HSH-CDY-23 074	2	4 526	82
	HSH-CDY-34 074	2	5 140	93
R449A	HSH-CDY-44 086	4	6 741	134
	HSH-CDY-44 108	5	7 817	158
	HSH-CDY-44 136	6 1/2	9 791	200
	HSH-CDG-1 014	1/2	1 399	20
	HSH-CDG-1 016	5/8	1 608	22
	HSH-CDG-2 018	3/4	2 510	38
	HSH-CDG-2 024	1	2 902	46
R449A	HSH-CDG-2 026	1 1/4	3 242	54
	HSH-CDG-3 034	1 1/2	4 056	71
	HSH-CDG-3 038	1 3/4	4 360	77
	HSH-CDG-3 048	2	6 160	116
	HSH-CDG-4 054	2 1/4	6 833	132
	HSH-CDG-4 060	3	7 652	149
	HSH-CDG-4 068	3 1/2	8 371	164

Equipos para bodegas

equipos para bodegas



Descripción Equipos para acondicionamiento de bodegas, en construcción semicompacta con unidad motocondensadora silenciosa o centrífuga y unidad evaporadora de tipo plafón con doble flujo de aire, dotada de resistencias de calentamiento, sistema de humidificación / deshumidificación, bomba de condensados, y en construcción compacta de techo, con condensación axial o centrífuga.

- Aplicación**
- Conservación de vino embotellado.
 - Conservación de tabaco.
 - Refrigeración de recintos a alta temperatura con humedad controlada.
 - Conservación de vino en barricas.
 - Curado de quesos.
 - Minisecaderos de embutidos.

- Serie VSF-G** Equipo semicompacto para bodegas con condensadora axial silenciosa.
Serie VSH-CG Equipo semicompacto para bodegas con condensadora centrífuga.
Serie VCR-N Equipo compacto para bodegas con condensadora axial.
Serie VCR-C Equipo compacto para bodegas con condensadora centrífuga.

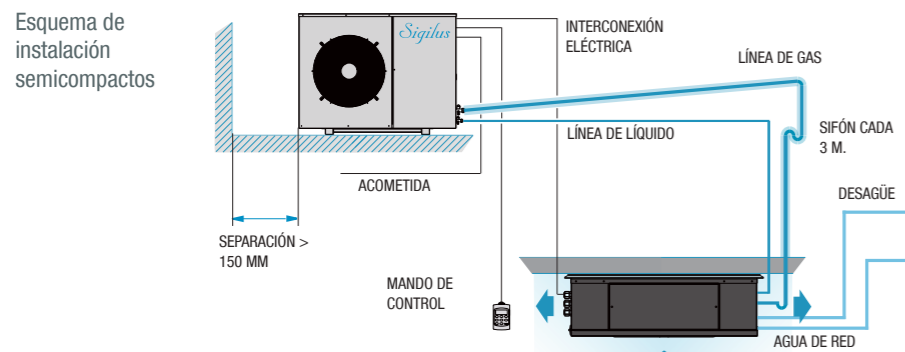

Distancia vertical máxima entre unidades de 15 m en caso de que la unidad condensadora esté situada a mayor altura que la unidad evaporadora, y de 6 m en caso contrario.

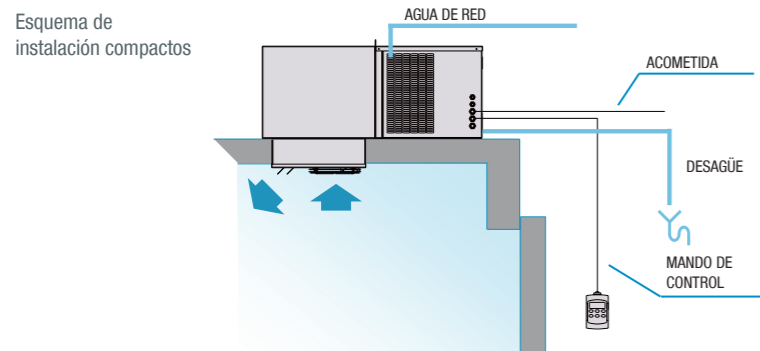

- * Equipos especialmente diseñados para conservación de vino en bodegas y cavas.
- * Control activo de humedad.
- * Sistema de calentamiento activo.
- * Equipos certificados en fábrica sin necesidad de ensayos in situ (RSIF).
- * Precarga de refrigerante incluida.
- * Equipos exentos de control de fugas.

Conservación de vino embotellado

El vino embotellado requiere condiciones controladas tanto de temperatura como de humedad que conserven de forma óptima el producto a la vez que eviten tanto el secado del corcho como el enmohecimiento de las etiquetas.

Los equipos de tratamiento de vinos garantizan condiciones óptimas de conservación de vino embotellado.



Conservación de vino en barrica

En la conservación del vino en barricas tiene una gran importancia la humedad relativa en el interior de la bodega, la cual debe estar ajustada para que no se produzca trasvase de vapor de agua entre el ambiente de la bodega y el interior de la barrica, evitando así mermas de vino o absorción de agua por parte del contenido.



Kit de humidificación de vapor externo

Humidificación a vapor de 3 kg/h de capacidad, compuesto por: lanzas de vapor integradas en la unidad evaporadora, un cilindro generador de electrodos sumergidos con válvulas de alimentación y purga de agua.



Interconexiones eléctricas

Para la interconexión de las unidades condensadora y evaporadora se han de prever las siguientes secciones de cable para 10 m de longitud (excepto serie 43 y 44).

Tensión	230 V-I-50 Hz	400 V-III-50 Hz
Sondas	4 x 1 mm ²	
Maniobra	10 x 1 mm ²	
Resistencia calefacción	2 x 2,5 mm ² + T	4 x 1,5 mm ² + T
Mando	2 x 1 mm ²	
Humidificador	2 x 1 mm ²	

Para conocer interconexiones eléctricas de cada modelo, ver manual técnico.

Características

- Alimentación 230 V-I-50 Hz o 400 V-III-50 Hz. Disponible 60 Hz
- Carga de refrigerante R-134a o R-449A reducida.
- Compresor hermético alternativo.
- Evaporador de plafón de doble flujo de aire con resistencias de calentamiento y sistema de humidificación / deshumidificación; baterías de evaporación con recubrimiento anticorrosión.
- Desescarche por aire; filtro de aire.
- Válvula solenoide y válvula de expansión termostática integradas en el evaporador.
- Bandeja de condensados en acero inoxidable y bomba de condensados.
- Conexiones de tipo Flare (hasta 1/2"-3/4") y válvulas de servicio.
- Recipiente de líquido con precarga de refrigerante para hasta 10 m de tubería.
- Control de condensación proporcional (series VSF 1/2/3 y VSH 4/43) y control de condensación todo / nada (series VSF 0 y VSH 2/22 y 3/33).
- Regulación electrónica multifunción con control de temperatura / humedad, y mando a distancia.
- Protección magnetotérmica.

serie VSF-G / VSH-CG



Bodegas

SERIE / MODELO	COMPRESOR		VOLUMEN BODEGA (m ³)		POTENCIA FRIGORÍFICA A 15°C/70% HR (W) ⁽¹⁾	POTENCIA CALORÍFICA (W)	POTENCIA ABSORBE. NOMINAL (kW) ⁽²⁾	POTENCIA ABSORBE. NOMINAL (kW) ⁽³⁾	INTENS. MÁX. ABSORBE. (A)	CAUDAL EIAP ⁽⁴⁾ (m ³ /h)	CAUDAL COND. (m ³ /h)	CONEXIÓN FRIGORÍFICA LIQ.-GAS	CARGA REFRIG. (kg)	PESO (kg)	NIVEL PRESIÓN SONORA dB(A) ⁽⁵⁾	
	CV	TENSIÓN	SIN AISLAR	AISLADA												
RT 34a	VSF-GY-00 010	3/8	230 V-I	11	37	1 242	1 000	1,52	0,52	8,8	500	350	1/4"-3/8"	< 1,5	46+30	28
	VSF-GY-10 015	1/2	230 V-I	20	53	1 820	1 000	1,67	0,67	10,1	500	1 700	1/4"-1/2"	< 2,0	57+30	34
	VSF-GY-11 033	1	230 V-I	47	100	3 281	1 500	2,76	1,26	16,3	1 100	1 700	1/4"-5/8"	< 2,5	67+42	34
	VSF-GY-12 053	1 1/2	230 V-I *	74	168	4 683	3 000	4,93	1,93	26,1	1 800	3 200	3/8"-3/4"	< 3,5	77+52	35
	VSF-GY-23 074	2	230 V-I *	149	297	7 497	6 000	8,60	2,60	43,7	3 150	3 700	3/8"-3/4"	< 5,5	79+75	34
	VSF-GY-33 108	5	400 V-III	224	444	9 944	6 000	9,50	3,50	26,1	3 150	4 000	3/8"-7/8"	< 6,0	98+75	35
R449A	VSF-GG-0 008	1/3	230 V-I	10	35	1 227	1 000	1,16	0,48	8,4	500	350	1/4"-3/8"	< 1,5	48+30	28
	VSF-GG-1 014	1/2	230 V-I	24	60	2 134	1 500	2,55	1,05	13,5	1 100	1 700	1/4"-1/2"	< 2,5	59+42	34
	VSF-GG-1 024	1	230 V-I	47	100	3 388	3 000	4,81	1,81	24,9	1 800	1 700	3/8"-5/8"	< 4,0	82+52	34
	VSF-GG-1 034	1 1/2	230 V-I *	75	170	4 944	3 000	5,55	2,55	29,9	1 800	3 200	3/8"-5/8"	< 4,0	83+52	35
	VSF-GG-2 048	2	400 V-III	151	300	7 830	6 000	9,19	3,19	17,9	3 150	3 700	1/2"-3/4"	< 5,5	84+75	26
	VSF-GG-3 060	3	400 V-III	221	450	10 490	6 000	10,87	4,87	19,5	5 200	6 500	1/2"-7/8"	< 6,5	88+75	26

Opcionales

- Cambio a alimentación 400 V-III-50 Hz.
- Control de condensación proporcional por variación de velocidad (incluido en VSF serie 1/2/3 y VSH 4/43).
- Separador de aceite.
- Tratamiento anticorrosión en poliuretano de batería de condensación.
- Rejilla exterior de protección de la batería.

Dimensiones evaporador

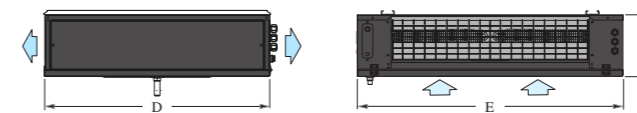

Dimensiones condensador

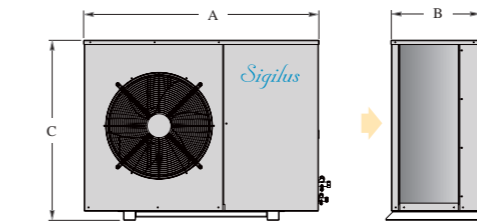

Dimensiones (mm)	A	B	C	D	E	F	Ventiladores evaporador
series 0 y 00	670	305	440	738	627	203	1x Ø 254
serie 10	1 030	373	577	738	627	203	1x Ø 254
serie 11 y VSF-GG-1014	1 030	373	577	860	706	253	1x Ø 360
serie 12 y VSF-GG-1024 y 1034	1 030	373	577	860	1 056	253	2x Ø 360
series 2 y 23	1 080	410	827	860	1 756	253	3x Ø 360
series 3 y 33	1 150	481	1 097	860	1 756	253	3x Ø 360

Otros refrigerantes.

- Consultar⁽¹⁾ Las prestaciones nominales están referidas al funcionamiento con temperatura de cámara de 15°C, humedad relativa de cámara del 70% y temperatura exterior de 35°C.
- Volumen de cámara para hostelería estimado sin aislar y volumen de bodega estimado con aislamiento de 30 mm.
- ⁽²⁾ Potencia absorbida nominal en modo de deshumectación.
- ⁽³⁾ Potencia absorbida nominal en modo de refrigeración.
- ⁽⁴⁾ Nivel sonoro referido a nivel de presión acústica en dB(A), medido en campo abierto a 10 m de distancia de la fuente.
- * Unidades disponibles en tensión 400 V-III-50 Hz.

Versión centrífuga, serie VSH -CG

Los equipos para bodegas se encuentran también disponibles en versión con condensadora centrífuga.

SERIE / MODELO	CV	CAUDAL COND. (m ³ /h)	PED. ⁽⁶⁾ (mmca)	
RT 34a	VSH-CGY-10 010	3/8	575	8
	VSH-CGY-21 015	1/2	1 000	12
	VSH-CGY-22 033	1	1 000	12
	VSH-CGY-33 053	1 1/2	1 500	14
R449A	VSH-CGG-2 014	1/2	1 000	12
	VSH-CGG-2 024	1	1 000	12
	VSH-CGG-3 034	1 1/2	1 500	14
	VSH-CGG-4 048	2	3 500	10
VSH-CGG-4 060	3	3 500	10	

⁽⁶⁾ Presión estática disponible en conductos de expulsión.

12 GALERÍA GALLERY GALERIE



