

DS-8104HMI-M(/XX) Embedded Mobile Net DVR
User Manual
(V1.20.00)

Statement

Please kindly note and understand that there may be misprints and technically inaccurate description. The contents of this manual are subject to change without notice from time to time accompanying with the release of new version. The listed products or programs will be improved or renewed whenever necessary.

Tips for users:

- Please install the DVR in well-ventilated places;
- Please make sure the DVR work in the allowed range of temperature and humidity;
- The dust board will cause a short circuit after damping; Please dedust regularly for the board, connector, chassis fan etc with brush.
- Please select the SD card manufacturers recommended SD which can meet the demand of DVR—long time, reading and writing large amount of data.

1	Production Description.....	6
1.1	Overview.....	6
1.2	Key Functions.....	6
2	Installation help.....	9
2.1	Check device and accessories.....	9
2.2	Interface Description.....	9
2.3	J1, J2, J3 and Aviation Connector.....	11
2.4	SD and SIM/UIM Installation.....	12
2.5	KEY Ignition Switch Connection.....	13
2.5.1	Connection for Time-Delay Shutdown.....	14
2.5.2	Connection for auto power on-off.....	15
2.6	Alarm Output Connection Guide.....	15
3	Operation Guide.....	17
3.1	Wire Control.....	17
3.2	Menu Description.....	19
3.2.1	Menu items.....	19
3.2.2	Menu Operations.....	20
3.3	Input Method.....	22
4	Basic Operation Guide.....	23
4.1	Power On.....	23
4.2	Preview.....	24
4.3	User name and password.....	24
4.4	PTZ Control.....	26
4.5	Manual Record.....	26
4.6	Playback.....	27

4.7	Backup Recorded Files	29
4.7.1	USB Backup.....	29
4.7.2	SD/SDHC Card Backup.....	30
4.7.3	Backup File Playback	30
5	Parameters Setup Guide.....	32
5.1	Basic Setting	32
5.1.1	Administrator and Password	32
5.1.2	Add and Delete User	33
5.1.3	Unit Name and Device ID	34
5.2	Local Preview Setup.....	35
5.2.1	Video output standard	35
5.2.2	Screen Saver Setup	35
5.2.3	OSD Setup.....	35
5.2.4	Video Parameters Setup	36
5.2.5	Mask Area Setup.....	36
5.2.6	Preview Properties.....	37
5.3	Alarm setup.....	38
5.3.1	External Alarm Input and Relay Output.....	38
5.3.2	Motion Detection Alarm	40
5.3.3	Video Loss Alarm	42
5.3.4	View Tampering Alarm.....	42
5.4	Recording Setup	42
5.4.1	Recording parameters description	43
5.4.2	Pre-Record Time and Post-Record Time	43
5.4.3	Record Schedule Setup	43
5.5	Network Parameters	44

5.6	PTZ	45
5.7	Exceptions	47
5.8	Mobile Setup	48
5.8.1	Boot & Halt Setup	48
5.8.2	GPS Setup	49
5.8.3	PPP settings	50
5.8.4	Server Login Setup	50
6	Utilities	52
6.1	Save Parameters	52
6.2	Restore Parameters	52
6.3	Upgrade	53
6.4	SD Card	53
6.5	Clear Alarm Out	54
6.6	Reboot	54
6.7	Power Off	54
6.8	View Log	54
6.9	System Information	55
	Appendix A SD Capacity Calculation	56
	Appendix B ETHERNET Connect Cable Made Method	58
	Appendix C Specifications	59
	Appendix D FAQ	61

1 Production Description

1.1 Overview

Embedded digital net recorder DS-8104HMI-M(/XX), which is an excellent product designed for vehicle surveillance. It supports local recording of SD/SDHC card, driving information recording, voice talk, GPS, wireless, alarm triggering and etc. This mini mobile DVR with lower power consumption is very easy to install. The chassis is made from aluminum and designed according to the requirement of thermal dissipation. It can work without fans and be prevented from dust, water and rust.

Key features:

- Support SD storage;
- Build in 3G wireless network module;
- Support GPS;
- Support shutdown delay and auto power on/off;
- Support ignition power on and power off delay;
- Specific platform for vehicle remote monitoring;

1.2 Key Functions

Compression technology

- 4-ch PAL/NTSC Vin, H.264 based. Choice of changeable bit rate and frame rate, configurable video quality and data rate;
- Each channel supports 4CIF (6fps), DCIF (12fps), 2CIF (15fps), CIF (full frame) and QCIF (full frame) encoding;
- 2-ch AIN, 16kps OggVorbis standard real-time compression;
- Choice of synchronously mixed video & audio and single video;
- Support dual-stream, local storage and wireless network transmission can be set separately;

- Support video parameters dynamic setting;
- Support OSD and LOGO.

Feature of local process

Video recording

- Variety of recording models: Schedule recording, manual recording, alarm recording, etc;
- Support SD card storage;
- SD card format FAT32;
- Management locking ensures the security of key information;
- Pre-allocation and low-seeking technology ensure recorded data be effectively scanned;
- SMART;
- Choice of recording modes cycle and non-cycle;
- Support USB 2.0, recordings backup and clip.

Preview and playback

- Portion (or whole) video mask;
- Portion (or whole) video mask alarm;
- Choice of playback modes fast forward, slow forward and single frame; Search by recording type and time;
- Indication of recording and alarm status.

Alarm

- Support speed limit alarm;
- 7-ch level signal alarm input, and 1-ch pulsing signal alarm input, 2-ch alarm output;
- Choice of alarm types motion detected, mask, video loss and sensor input;
- Alarm schedule setup;
- A series of exception alarm, such as SD card error and video format conflict.

Security

- Customizing authority for operators by the administrator. Support multi-administrators, more flexible security management;
- Channel based authority for remote preview and playback and local playback.
- A supper user with user name admin, password 12345 by default.

Network

- TCP/IP based;
- Wireless comfortable compression technology;
- Software for alarms e.g. triggered signal, exception and GPS alarm;

- Audio preview and screen capture at client software;
- PPP enabled;

Client developing

- Network protocol provided for platform system development.
- SDK provided for client development.
- DEMOs with source code provided.

2 Installation help

2.1 Check device and accessories

Please check carefully according to the list inside once you get it.

2.2 Interface Description

DS-8104HMI-M(/XX) front panel is shown as below: (Note: the descriptions are subject to the physical product)

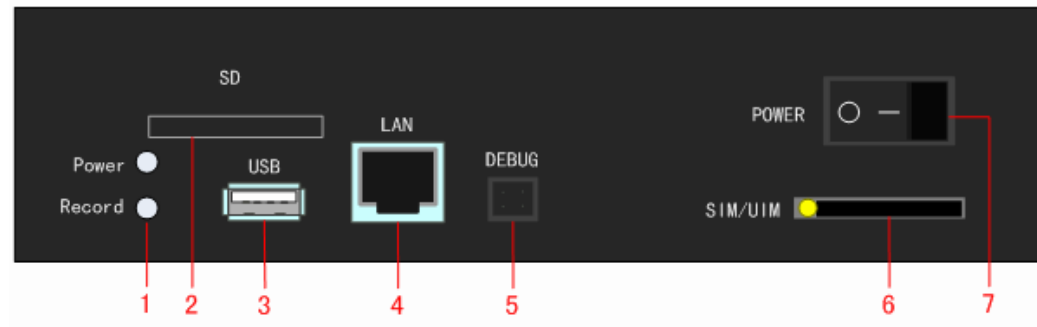

Fig 2.1 DS-8104HMI-M front panel

No.	Interface	Description
1	Power	Power indicator. The indicator will turn red when DVR is standby and turn green when DVR is power on;

	Record	Recording indicator. The light will turn green when recording.
2	SD	SD card socket;
3	USB	Connect to USB devices, support USB 2.0;
4	LAN	Connect to ETHERNET devices;
5	DEBUG	Device debug port, connect with special cable in accessories box;
6	SIM/UIM	SIM/UIM card socket, the yellow bar is for pushing card out;
7	POWER	Power switch

DS-8104HMI-M rear panel is shown as below: (Note: the descriptions are subject to the physical product)

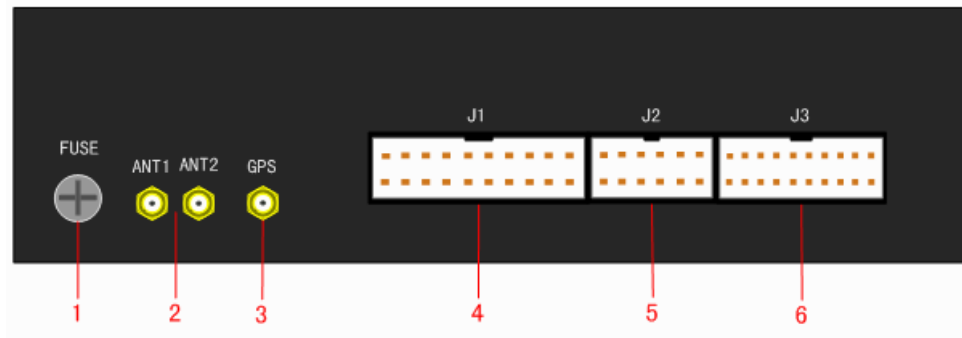

Fig 2.2 DS-8104HMI-M rear panel

No.	Interface	Description
1	FUSE	Fuse connection interface;
2	ANT1 ANT2	Wireless network antenna interface; 1 is main, 2 is aux;
3	GPS	GPS antenna interface;

4	J1	Video&Audio input/output
	J2	Dc in, KEY and KB port
5	J3	Alarm in/out, RS485

2.3 J1, J2, J3 and Aviation Connector

Detail description for interface J1, J2 and J3:

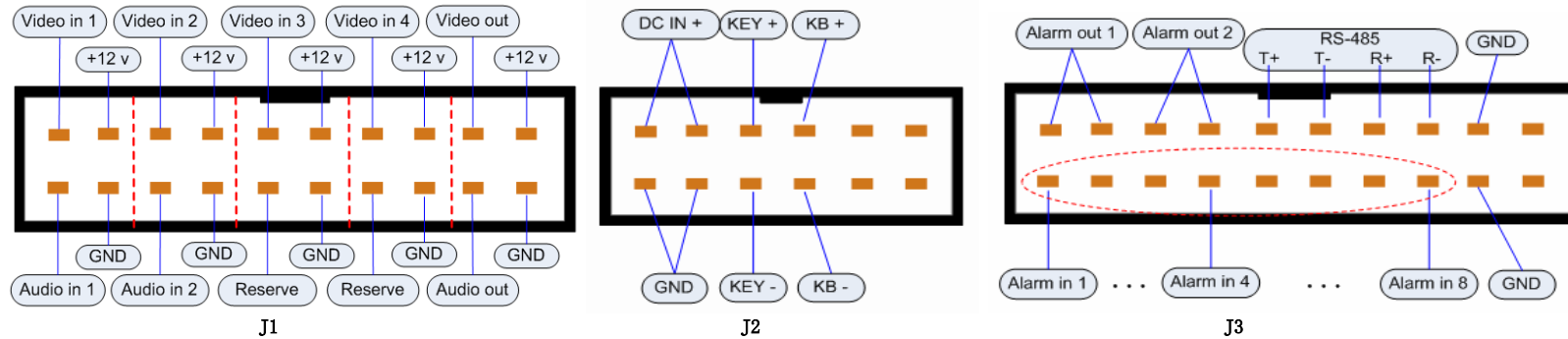

Fig 2.3 J1, J2 and J3 interfaces

Note:

1. Video In 1 and Video In 2 have corresponding Audio In interfaces, Video In 3 and Video In 4 do not have.
2. Support wide range power supply (DC6V to DC36V), but the power consumption for power on should be more than 36W.
3. In J3 interface, alarm inputs 1 to 7 are level signal, and alarm input 8 is pulsing signal.

Detail description for aviation jack:

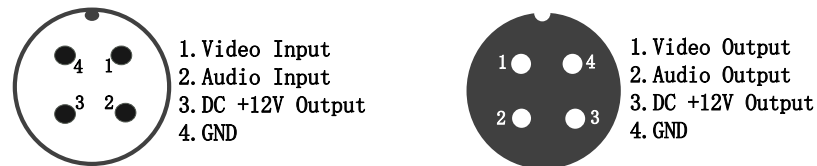

Fig 2.4 Aviation connector definition (Left side is input channel, 4 male connectors; right side is output channel, 1 female connector.)

2.4 SD and SIM/UIM Installation

Note:

1. **When install SD card or SIM/UIM card, please make sure the operation is under power off**, or it will give rise to SD card or SIM/UIM card damage.
2. Tips for SD purchase: please choose recommended high-quality SD from creditable provider (e.g. Kinston, SunDisk, Transcend and etc), that should be comfortable for longtime and frequent read & write; the capability should more than 1GB.
3. SD should be formatted after the installation, or there may be SD error with alarm. Format method please refer to section 6.4 ;
4. With the default configuration, the corresponding recording times for different Volume are:

SD volume (Unit: GB)	Recording time(Bit Rate: 512Kbps Unit: Hour)	Recording time(Bit Rate: 1Mbps Unit: Hour)	Recording time(Bit Rate: 1.5Mbps Unit: Hour)
16	72	36	24
32	144	72	48

Declaration: Recording time may be not so precise, it is just for reference, and we will not take the responsibility for this.

1. SD card installation



Fig 2.5

Before installation, please make sure the card face up (as in fig 2.5), and follow the steps:

- (1) SD card with copper sheet face up;
- (2) SD card with missing angle side face the slot;

After these two steps, push it into the slot. When hear “click”, this means the SD card is installed. You can check the installation status by push the card. When the card can eject, that means the SD card is installed.

2. SIM/UIM card installation

- (1) Use a pin to push the yellow bar besides the SIM/UIM slot and eject the card board;
- (2) Put the card on the board;
- (3) Insert the card board into the slot.

2.5 KEY Ignition Switch Connection

Note:

1. The basic two power on conditions for mobile DVR:

- (1) Power supply interface has correct power connection;
- (2) KEY interface has correct power connection;

In practice, please connect “+ -” of DC IN to vehicle battery, and KEY to ignition switch or batteries, the details please refer to the below connection figures.

2. Please make sure that the positive pole of DVR power line connects the positive pole of vehicle batteries with the fuse.

3. There are two kinds of vehicle ignition switch connection: positive and negative connections:

- (1) Positive pole ignition switch: ignition switch is connected to the positive pole of vehicle battery and supply high signal (as in Fig 2.6)
- (2) Negative pole ignition switch: ignition switch is connected to the negative pole of vehicle battery and supply low signal (as in Fig 2.7)

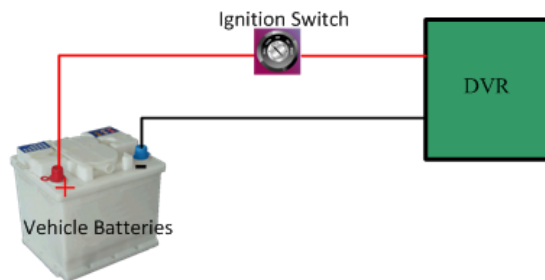

Fig 2.6 Positive pole ignition switch

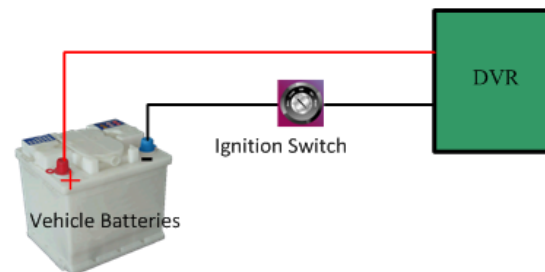

Fig 2.7 Negative pole ignition switch

2.5.1 Connection for Time-Delay Shutdown

Connect DC+ and DC- to power supply (battery) positive and negative poles, connect KEY interface to **the vehicle ignition switch** for DVR function of vehicle ignition startup and time-delay shutdown. There are two kinds of vehicle ignition switch:

(1) Connection of Positive Pole Switch (Fig 2.8):

- Connect the "DC IN +" of DVR to the positive pole of vehicle batteries;
- Connect the "KEY +" of DVR to the vehicle ignition switch;
- Connect the "GND" and "KEY -" of DVR to the negative pole of vehicle batteries.

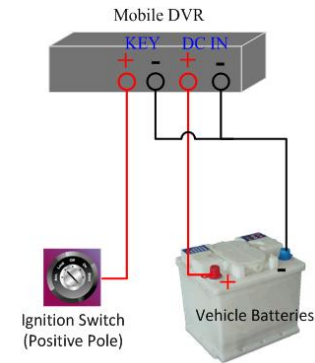

Fig 2.8 KEY connect with positive ignition switch

(2) Connection of Negative Pole Switch (Fig 2.9):

- Connect the "DC IN +" and "KEY +" of DVR to the positive pole of vehicle batteries;
- Connect the "KEY -" of DVR to the vehicle ignition switch;
- Connect the "GND" of DVR to the negative pole of vehicle batteries.

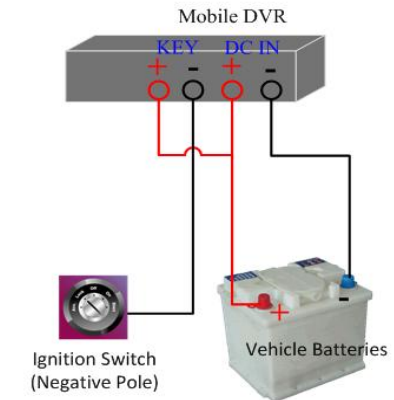

Fig 2.9 KEY connect with negative ignition switch

After KEY connected to the switch, when switch on, the DVR will start up with the vehicle; when switch off, the DVR will shut down within the preset delay time. More information on the time-delay shutdown function can be found in section 5.8.1

Note: Please contact the vehicle battery manufacture for the information on the voltage polarity.

2.5.2 Connection for auto power on-off

Connect DC+ and KEY+ to the vehicle batteries positive pole and DC- and KEY- to the vehicle batteries negative pole for the DVR auto on-off function. The connection is as Fig 2.10. The settings details please refer to section 5.8.1.

DS-8104HMI-M (/XX) series mobile DVR working consumption is less than 10W. If you need a long auto working time, please considering standby power supply according to the conditions.

Note:

1. When testing the DVR, please refer to the power connection. When the basic two power on conditions are met, the DVR will work.
2. To make sure the DVR can power on normally, the power consumption should be more than 36W, the working voltage is DC 6V to 36V.

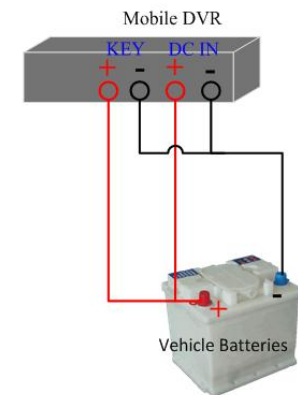

Fig 2.10 KEY connect with vehicle batteries

2.6 Alarm Output Connection Guide

Alarm Input connection:

DS-8104HMI-M(/XX) series mobile DVR is applied high and low level signal to trigger the alarm input. DC 0V to 5V is low level signal, DC 6V to 36V is high level signal. To avoid misidentification, signal between DC 5V to 6V will not be handled. The alarm input connection is as Fig 2.11:

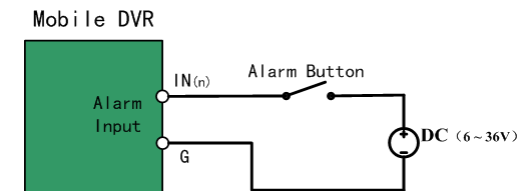

Fig 2.11 Alarm Input Connection

Alarm Output connection:

DS-8104HMI-M(/XX) series mobile DVR is applied closed signal to trigger the alarm output. That means when alarm output is triggered, the Alarm OUT and GND will be connected status, that means user must connect alarm device with power supply.

The alarm output connection is as Fig 2.12:

Connection Description

Detailed steps are as below:

1. Pull out the green plug in the device;
2. Loosen the screws in the plug with mini cross screw, insert the signal wire into the corresponding pinholes;
3. Then insert the green plug into the corresponding socket.

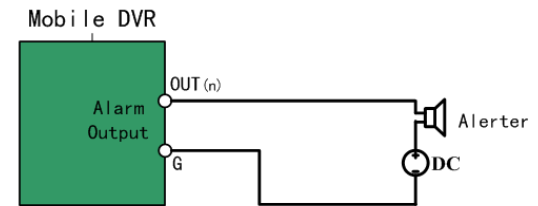

Fig 2.12 Alarm Output Connection

3 Operation Guide

3.1 Wire Control

No.	Name	Description
1	POWER	Reserved
2	DEV	Reserved
3	Numeric Keys	Input number, upper and lower case, symbol, and Chinese character.
4	EDIT	1. Enter the edit state, and then delete the character in the front of the cursor; 2. Switch between ✓ and × in the status box
5	A	1. Switch between input methods (Number, English, Chinese, Symbol); 2. Display or hide the channel status in the preview interface.
6	REC	Manual Recording;
7	PLAY	Playback;
8	INFO	Reserved
9	VOIP	Reserved
10	MENU	Switch from preview interface to menu interface.
11	PREV	Multi-screen switch;



Fig.3.2

12	Direction Keys	Up [↑], Down [↓], Left [←], Right [→]: 1. In menu mode, moving the activity frame by press [←] & [→], and selecting the data items by press [↑] & [↓]; 2. PTZ Position Control; 3. Playback fast, slow, forward and rewind.
	ENTER	1. Confirm when in menu mode; 2. Switch between ✓ and × in the status box ; 3. Pause when playback
13	PTZ	Enter PTZ Control mode
14	ESC	Cancel and return to previous menu
15	Reserved	
16	F1	Reserved
17	Lens Control	Adjust Iris, focus and zoom.
18	F2	Reserved

3.2 Menu Description

3.2.1 Menu items

Item	Option	Item	Option	Item	Option
Display	Unit Name Device ID Require Password Screen Saver Video Standard Enable Scaler Menu Transparency DST Date & Time	Image	Select Camera Name & Position Brightness, Contrast, Hue, Saturation OSD & Position Privacy Mask View Tampering Signal Loss Motion Detection Copy to Camera	Recording	If SD full Overwrite /Stop Recording Stream Type, Resolution, Bit Rate Type, Max Bit Rate, Image Quality, Frame Rate Enable Recording Pre-Recording Time & Post-Recording Time Copy to Camera
Network	Basic network parameters, e.g. IP, Mac... Multi-cast IP Http Port DNS IP Remote Host & Port Download Server PPPoE	Alarms	Alarm In & Type Alarm Handling Copy to Alarm In Alarm Out & Time Alarm Out Schedule Copy to Alarm Out	Exceptions	Exception Type Handle Method: Audible Warning, Upload to Center, Trigger Alarm Out
PTZ	Camera Baud Rate, Data Bits, Stop Bits, Parity, Flow Control, Protocol PTZ Address Preset, Sequence, Cruise	RS232	Reserved	Preview	Preview Mode Switch Time Audio Preview Display Delay Layout

	Copy to Camera				
User	Add & Del User Password & Verify Default & Set Right	Mobile	Boot & Halt GPS PPP WVS IVMS	Utilities	Save Parameters Restore Parameters Upgrade SD Card Stop Alarm Out Reboot Power Off View Log System Information

3.2.2 Menu Operations

You can enter the menu interface by using IR control

- Press [MENU] button to enter the menu interface.
- Press [PLAY] button to enter the playback interface.
- Press [REC] button to enter the manual record interface.
- Press [PTZ] button to enter the PTZ control interface.

Note: Password is required; and the default user name is “admin”, password is “12345”.



Fig 3.3



Fig 3.4

There is a rectangular box in the main menu interface, which is referred to as “Activity Frame”, you can move it from one icon to another by pressing [◀] or [▶] on the IR control. When the “Activity Frame” stops at one icon, you can press [ENTER] to enter the submenu of corresponding icon, shown as Fig. 3.3. For example, move the “Active Frame” to “Image” icon, press [ENTER] to enter into the secondary menu, show as Fig.3.4

Take “Image” interface as an example to explain the menu and operation rules:

Each menu contains different kinds of items. There is a small rectangular frame named “Active Frame” which is pointing to the selected item. This “Active Frame” can be moved by [◀] or [▶] keys. There are such kinds of menu items:

- a) Check Box: Provide 2 options, “✓” means enable and “x” means disable. You can use [ENTER] or [EDIT] key to switch over.
- b) List Box: Provide more than 2 options. However, only one of them can be selected. You can use [▲] and [▼] to select one option. For example, on the right side of “Select Camera”, there is a list box for you to select one camera.
- c) Edit Box: This is for you to input characters. Press [EDIT] key to enter into edit status, you can input characters as following:
 - i. Press [A] key to select number, upper case, lower case or symbols;
 - ii. Use [◀] and [▶] keys to move cursor;
 - iii. Use [EDIT] key to delete the character in front of cursor;

- iv. Press [ENTER] or [ESC] to exit edit.
- d) Button: Execute a special function or enter into next sub-menu. For example, press “Policy” button to enter into sub-menu. Press [**Confirm**] to save parameters and return to parent menu. Press [**Cancel**] button to cancel and return to parent menu. The button in grey means it can be operated only after it is enabled.

Exit Menu

You can press [ESC] to return to previous or preview interface, also press [PREV] to return from menu to preview interface.

3.3 Input Method

In the submenu interface, if entered the edit mode, there will be an item at the bottom of the screen, you can input the characters in the edit box by pressing [**Numeric Keys**] on the IR control.

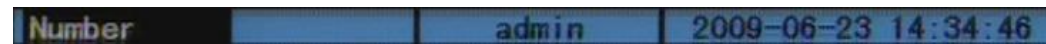

If you want to input English (i.e. uppercase), just switch the input method to “Uppercase” by pressing [A] until the item shown as follow, then you can input uppercase in the edit box with [Numeric Keys] buttons on the IR control (The same as the method of entering the letters in mobile phones.).



Besides, the following input methods are supported as well: Lowercase and Symbol. There are 24 symbols in all and divided into 4 pages for choice, you can turn over the pages by pressing [0] on the IR control.

Note: In this user manual, the “button” on IR control is denoted as [Button Name], e.g. [Playback] denote “playback button”, [Enter] denote “enter”. The parameter in the menu interface is denoted as “Parameter Name”, e.g. “Name” denote camera name edit box.

4 Basic Operation Guide

Note: The user must have the appropriate rights for basic operations described in this chapter. The following Fig.4.1. are login prompt boxes:

In this box, you can use [▲] and [▼] to select one username, then press [▶] to move to password. After entering the password, please press [ENTER] to exit the password box and press confirm to enter the menu. If there is an alarm, which means the input password mismatched the username. If the mismatch happened three times, the system will logout automatically.

Note: “admin” is the administrator with the highest authority.

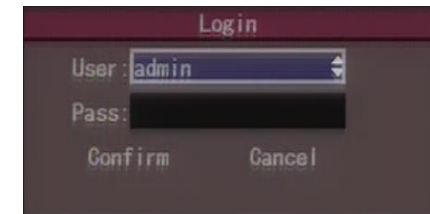

Fig.4.1

4.1 Power On

Notes: Please confirm that the power supply matches the working requirement of DVR, and make sure the grounding is good. Please make sure that there is a monitor connected to VOUT interface on the rear panel of DVR, so as to operate the device with the visible menu.

After power-on and switch on the ignition, the device begin to start up, the [POWER] indicator is turn green. When [Ready] turn green, means this device is ready to be controlled by IR control. The initialization status of DSP will show up in the first row up the display or monitor; if the DSP icon is marked with “x”, it means initialization failed, please contact the supplier in time. The initialization status of SD card will show up in the second row; if the SD card icon is marked with “x”, it means the SD card is undetected or not installed.

You can control the device with wire control, only if the [Ready] indicator is turn green and the device start up ready.

Note: If the SD card is undetected or not installed, there will be an audible warning from buzzer as the DVR starts up. You can cancel the audible warning by changing the “Audible Warning” status in the “SD Error” option of the “Exceptions” submenu. We suggest you to enable this warning function to make sure that you can get the SD working status.

4.2 Preview

The preview interface will show up after the device started up.

The date, time, channel name and GPS info (Enable GPS function) can be seen in the preview interface, if you want to reset them, please refer to the section 5.2.3 OSD Setup. There are recording and alarm status of each channel displayed at the bottom of the screen. The two kinds of status will switch over automatically, which will hide or display by pressing [A].

Icons Descriptions of Recording & Alarm status

Recording			Alarm		
Icon	Color	Status	Icon	Color	Status
○	White	No Video	○	White	Video Lost
●	Yellow	Video Input	●	Yellow	View Tampering
●	Pink	Manual Recording	●	Pink	Motion Detection & Sensor Alarm
●	Green	Schedule Recording	●	Green	No Alarm
●	Blue	Motion Detection Recording	●	Blue	Motion Detection
●	Red	External Alarm Recording	●	Red	Sensor Alarm

Press [Numeric Keys] buttons, you can switch to the channel directly.

Press [EDIT], you can switch the channel in order, and preview the corresponding camera.

Press [PREV], you can switch the preview layout.

4.3 User name and password

Note: When DVR is delivered from factory, there is only one default administrator named “admin”, and password is “12345”. The administrator’s name can not be modified, while the password can be modified. Please change the default password to ensure the data security. The administrator can create 15 users and define

their user rights.

Modify password for the users created by admin:

For example, a user named “user” (The method of adding and deleting user please refer to section 5.1.2), please modify the password as follow:

Step 1: Enter the main menu and select “User” icon. (Fig.4.2)

Step 2: Input the new password and confirm it. (Fig.4.3)



Fig.4.2

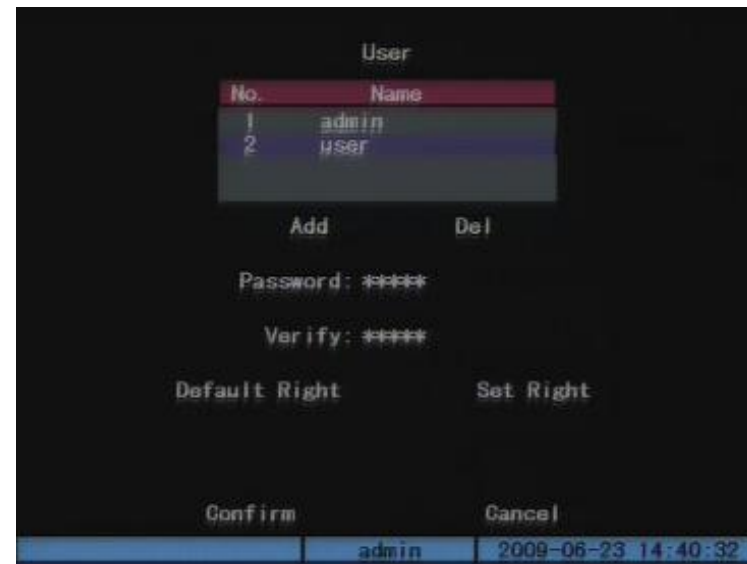

Fig.4.3

4.4 PTZ Control

Note: The user must have the “PTZ Control” right.

Under the main menu mode, press the “PTZ” to enter the PTZ control interface.

PTZ control keys description:

- Direction control keys:[▲],[▼],[◀],[▶];
- ZOOM control keys:[ZOOM+],[ZOOM-];
- FOCOCUS control keys:[FOCUS+],[FOCUS-];
- IRIS control keys:[IRIS+],[IRIS-];
- Adjust preset keys: [REC/SHOT] + three[numeric key],example[REC/SHOT] +”001”means call preset 1
- Auto control key:[PLAY/AUTO];

Exit the PTZ control operation menu:

If you want to do the other operation, such as playback, manual record and so on, you need to exit the “PTZ” operation menu. Press the [ESC]button to exit and go back to the preview mode.

4.5 Manual Record

Note: The user must have the corresponding right.

Press[REC]key to enter the “Manual Record” interface.(Fig 4.4)

Start Recording: you can start corresponding channel recording by set “Start/Stop” status as “x”, or press “Start All” to start all channels recording.

Stop Recording: you can stop corresponding channel recording by set “Start/Stop” status as”V”, or press “Stop All” to stop all channels recording.



Fig. 4.4

Exit manual record:

Press[ESC] key to exit manual record and enter preview mode. Press[MENU]key to enter main menu. Press[Play]key to enter into playback menu. Press[PTZ]key to enter PTZ control mode.

4.6 Playback

Note: The user must have “Playback” right.

Press [PLAY] key enter “Playback “interface(Fig.4.5):



Fig.4.5

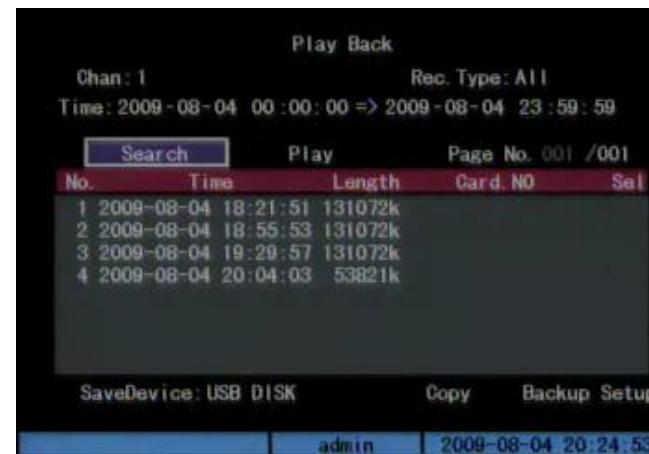

Fig.4.6

Playback operations:

In the playback interface, you can set search channels, record type, time section, and select “Search” button. DVR will search and list the matched files. (Fig.4.6) If the matched files are more than 8, you can use “Page No.” to select page. In the file list box, use [▲], [▼]keys to move the scroll bar to the file, press [ENTER]key to playback the file.

If directly press “Play” button, after setting the channel, record type and time section, DVR will start to playback based on time section.

If DVR cannot find the matched files, then a failure dialog will pop-up, as shown in Fig.4.7.

At the bottom of image, there is an information bar with the Volume, Play Process, Play Speed, Played Time and File Total Time. (Fig.4.8)

Playback control keys description:

- Display/ Hide information bar:[MENU];
- Open/Close sound:[PLAY],under the mute mode,“x”will appear on the bar;
- Adjust play progress: [◀] (Backward), [▶](Forward). The unit is“%”;
- Adjust play speed: Use [▲] to increase play speed, use [▼] to decrease play speed. (MAX: 4x)
- Pause/ Continue: Press [ENTER] to pause/continue playback. If played frame by frame, press[ENTER]to play one frame;
- Exit:[ESC];

Note:1. When the DVR is busy working, if select high speed playback, the actual speed will has some deviation.

2.When the DVR is recording, high speed playback may affect the recording.

Exit playback:

In playback interface, press[ESC]key to exit and enter preview mode.

In playback interface, press[MENU]key to enter main menu, press[REC]key to enter manual record, and press[PTZ]key to enter into PTZ control mode.



Fig.4.7



Fig.4.8 Playback Image

4.7 Backup Recorded Files

4.7.1 USB Backup

Note: The user must have “Playback” right. Please connect with backup devices first, such as USB flash, USB HDD and SATA device.

Please enter the layback interface to apply the backup operation. (Fig.4.9)

There are two methods of backup:

1. Backup the selected recorded files.

In the playback interface, search the matched files, move “Active Frame” and press [Edit]key to select the files . The symbol “v”is the selecting tag. Then select backup device, move “Active Frame” to “Copy” button and press [ENTER]key to start backup.

You also can backup the image segments when the image is being playback. The steps are as follow:

Step 1: Enter the interface of playback the files or playback by time;

Step 2: Press [EDIT]key to start selecting the current playback image, and press [EDIT]again to stop selecting. This segment is selected;

Step 3: You can repeat step 2 to select more segments. (30 MAX)

Step 4: After you select all segments, Press [ESC]key, a message window will pop-up. If you press “Confirm” button, DVR will start to backup the selected segments. If you press “Cancel” button, DVR will abort the backup.

2. Backup all the files in a certain period of time.

After entering the playback interface, move “Active Frame” to “Backup Setup” button, press [ENTER] key to enter the backup menu (Fig.4.10).Firstly, select the “Save Device” and “Camera” (“v”means the



Fig.4.9 Backup Recorded Files

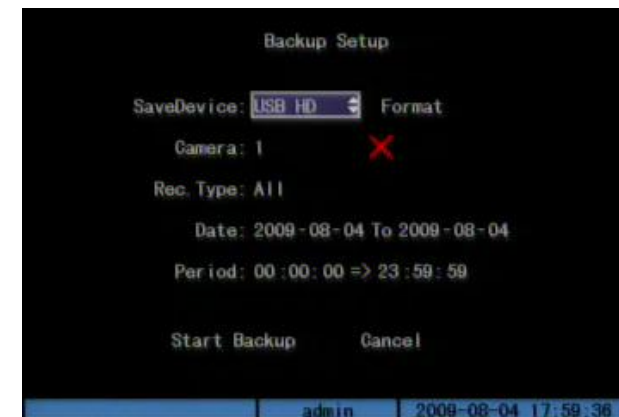

Fig.4.10 Backup the files in a certain period

camera is selected, press [EDIT] to switch “x” and “v”). Secondly, select “Rec. Type” and set “Date” and “Period”. Lastly, move the “Active Frame” to “Start Backup”, and press [ENTER] to start backup.

If there is no file in the selected period, after pressing [ENTER] will back to playback interface.

Note:

1. The backup disk should be FAT32, if not, please format it first. Format method is : after choosing the “Save Device “, the “Active Frame” will on “Format”, press [EDIT] to start formatting;
2. If “Device Error” dialog (Fig.4.11) pop-up, please check the device connection.

4.7.2 SD/SDHC Card Backup

User can directly push out the SD/SDHC Card, use Card Reader and MVA (Mobile Video Analysis) software to playback and download recorded files. The details please refer to the user manual of MVA.

4.7.3 Backup File Playback

Backup files naming rule:

Backup files will be saved in the file named with the DVR name. (Please refer 5.1.3 for the DVR name details.) The files can be searched by their names, for example, in a folder named “CABX 5523” there is a file with name “ch01-200808071029.mp4”, that means this file is the record video of DVR named “CABX 5523” channel 1, the beginning time is 10:29 on 2008/8/7.

1. Playback multi-channel backup files.

MVA software can be used to playback multi-channel backup files. If DVR has GPS function, the recording file can be playback with the position displayed on the map. The details please refer to the MVA user manual.

2. Playback one backup file.

Please use our company’s player which can be found in the CD to play the file. You can also download the plug-in from our website to play it with other software.

5 Parameters Setup Guide

Note: only the users have “Parameters Setup” right can set the parameters.

You must reboot the DVR to make the new parameters take into effective, when the following parameters are modified and saved. (Fig.5.1) Other parameters do not need to reboot.

- Any network parameters
- Stream type, resolution and record schedule
- External alarm sensor type
- View tampering alarm schedule
- Video lost alarm schedule
- Motion detection alarm schedule
- External alarm schedule
- Login server parameters
- Wireless network parameters

5.1 Basic Setting

5.1.1 Administrator and Password

When DVR is left from factory, there is one default administrator. The name is “admin” and password is “12345”. The name cannot be changed, while the password can be. For security reason, please change the password after you receiving the device.

Step 1: Open the main menu, and enter “User” menu; (Fig.5.2)

Step 2: Use [▲],[▼]key to choose a user name;

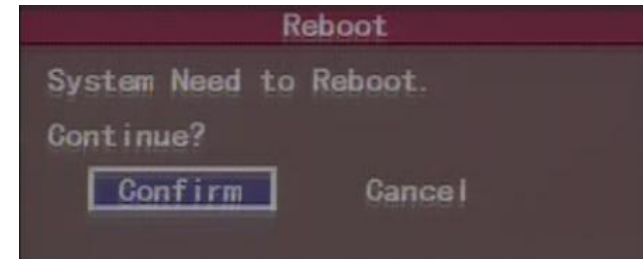

Fig.5.1



Fig.5.2

Step 3: Use [◀],[▶]key to move “Active Frame” to password edit box, input the new password. Move “Active Frame” to “Verify password” edit box, input the verify password. Then choose the “Confirm” button, the password will be saved and taken into effective.

Note: When the “Active Frame” on the user name, please use[▲],[▼]key to choose one user, use[◀],[▶]key move the active frame to other options.

If password and verify password are not same, a warning message box will be appeared.

Suggestion: To facilitate the operation of first time setting, you can disable the password in the “Display” menu. (Fig.5.6) Setting the “Require Password” status as “x”.

Note: For security reason, it is better for you to set “Require Password” as “✓”after completing all the setup.

5.1.2 Add and Delete User

Select “Add” in “User Management” interface to add new user in pop-up “Add” menu, and return “User Management” menu to define password and rights.(15 User MAX.)

User rights description:

“Local Rights”: Local rights are for local operation, such as the operation using IR controller and RS-485 keyboard.

- PTZ control: Locally control PTZ;
- Record: Manual start/stop recording;
- Parameters Setup: Locally setup the DVR parameters;
- Log: Locally view the log on DVR;
- Utilities: Locally upgrade firmware, format SD, reboot DVR and shut down DVR, etc;
- Playback: Local playback and backup the recorded files.

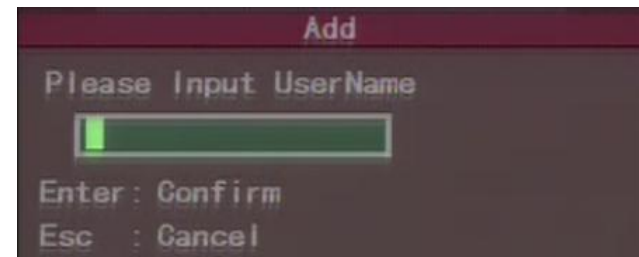

Fig.5.3



Fig.5.4

“Remote Rights”: Remote rights define the rights of operating by IE or Client Server.

- PTZ control: Remote control PTZ;
- Record: Remote manual start/stop recording;
- Parameters setup: Remote setup the DVR parameters;
- Log: Remote view the log on DVR;
- Utilities: Remote upgrade firmware, format SD, reboot DVR and shut down DVR, etc.
- Voice: Client talks with DVR;
- Alarm: Remote control DVR alarm output;
- Local video out: Remote control DVR video output;
- Com control: DVR RS-232 transparent channel function;
- Preview: Network live preview;
- Playback: Remote playback, download the recorded files on DVR.

MAC address:

This MAC address is not the address of DVR but the PC that will access DVR. If you setup this MAC address, only the PC with this MAC address can access this DVR. At PC end, in DOS prompt, you can use “ipconfig” command to get the PC MAC address (6 bytes).

Delete user:

In “User Management” interface, you can select one user, then move active frame to “Del” button, press [ENTER], in the pop-up confirmation dialog, press “Confirm” button to delete the selected user and return. (Fig.5.5) Please notice that “admin” is undeletable.

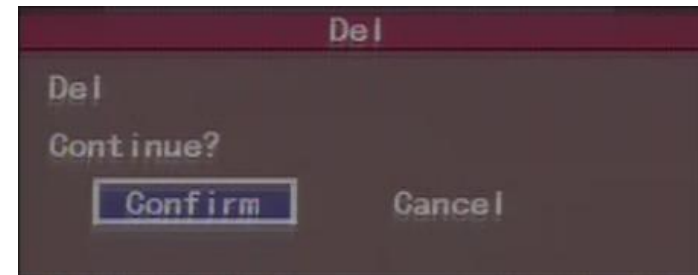

Fig.5.5

5.1.3 Unit Name and Device ID

The unit name and device ID can be set in “Display” menu. (Fig.5.6)

Unit name is the name of DVR; it can be modified according to the requirement of monitoring. For example, it can be named as the car license number to facilitate the search of backup files.

Device ID is the ID for IR control. The default device ID of DVR is "255". The device ID value is ranged among 01-255.

5.2 Local Preview Setup

5.2.1 Video output standard

The device supports PAL or NTSC video output. The video input standard is adaptive. You can modify video output standard to match video input in "Display" menu.

5.2.2 Screen Saver Setup

If the user operates nothing for a period of time, the device will return to preview automatically. The screen saver is used to control the time. This parameter can be set in "Display" menu (Fig.5.6).The options have 1min, 2min, 5min, 10min, 20min,30min and NEVER.

5.2.3 OSD Setup

OSD is abbreviation of "On Screen Display". It includes displaying system time and camera name. OSD setting include: System time, time format, time display position, camera name, camera name display position, etc.



Fig.5.6

In “Display” menu, you can setup DVR system date and time.(Fig.5.6) In “Image Setup” menu (Fig.5.7), you can setup time display position in the image. Move “Active Frame” to “Position” button on the right side of “OSD” and enter setup image, you can use[▲],[▼],[▶],[◀]keys to move the OSD position. Press [EDIT]key to select OSD format. There are following OSD formats:

MM DD YYYY W hh: mm: ss (default)
 MM DD YYYY hh: mm: ss
 YYYY MM DD W hh: mm: ss
 YYYY MM DD hh: mm: ss

Note: Here YYYY means year, MM means month, DD means day, W means weekday, hh means hour, mm means minute and ss means second.

In “Image Setup” menu, you can define name for each camera. On the right side of camera name is “Position” button, you can setup camera name position by pressing this button. You can copy the position to any other camera, but please note that camera’s name can not be copied.



Fig.5.7

5.2.4 Video Parameters Setup

The video parameters include brightness, contrast, hue and saturation. The parameters will affect the preview image and recorded image. In “Image Setup” menu (Fig.5.7) , you can modify the parameters by entering “Adjust” interface.

5.2.5 Mask Area Setup

In some cases, maybe you want mask the sensitive area. This area will not be preview and recorded. You can setup the area in “Image Setup” menu.

Enable the check box beside “Privacy Mask” item, changes the flag into “✓”. Press “Area” button on the right of mask check box and enter mask area setup interface. (Fig.5.8) There is one small yellow pane on the upper left side of the interface. For PAL camera, the whole screen is divided into 22*18 panes(22*15 for

NTSC). Firstly, move the yellow pane to your hope position and press[EDIT]key, the yellow pane will be turned into red, then you can use[▼]to expand downward ,[▲]to shrink upward,[▶]to expand rightward,[◀]to shrink leftward. After you make sure the red mask area, press[EDIT]key to save the mask area. The area will be blacked in the preview image.(Fig.5.9) Press[ESC]key to cancel the mask area. The maximum mask area is the full screen and the minimum size is only one pane. You can setup 4 mask areas at most. Press[A]key to clear all mask areas.

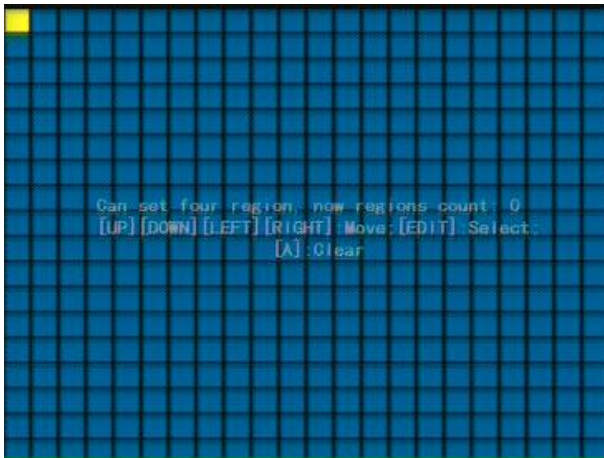

Fig.5.8 Mask Area Setup Interface

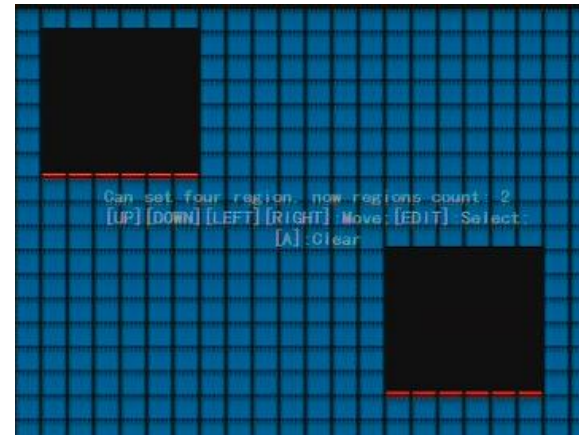

Fig.5.9 Preview Image with Mask

Note: The mask areas can not be copied to other cameras. There is no preview image and record image in the areas.

5.2.6 Preview Properties

In “Preview” menu, you can setup preview mode, screen switch time, enable or disable audio preview and preview layout.

Step 1: Enter into “Preview” menu. (Fig.5.10)

Step 2: Preview properties:

- **Preview mode:** You can use [▲] or [▼]key to select one mode. There are “1 Screen” and “4 Screen” option.

- **Switch time:** That is image preview switch time. You can use [▲] or [▼] keys to select switch time. There are many options, including “5 Seconds”, “10 Seconds”, “20 Seconds”, “30 Seconds”, “1 Minutes”, “5 Minutes” and “Never”. If you select “Never”, the preview image will not be switched automatically. For example, if you select “1 Screen” preview mode and “20 Seconds” switch time, DVR will cycle display 1 channels image every 10 seconds.
- **Audio preview:** If you need audio preview, please use [ENTER] or [EDIT] to enable audio preview as “✓”. If not, please set it as “x”.
- **Alarm display delay:** You can setup the display delay time of switching to the alarm channel by using [▲] or [▼] keys to select a time in the “Display Delay” list. The options have “1s”, “2s”, “3s”, “4s”, “5s”, “6s”, “7s”, “8s”, “9s” and “10s”. For example, if you select “4 Screen” preview mode, “10s” alarm display delay time, DVR will display 4 channels, when there is an alarm from camera 1; the screen will switch to camera 1 after 10 seconds.
- **Preview layout setup:** There is a square frame divided into many windows. If you select “4 Screen” preview mode, this frame is divided into 4 windows. Each window represents one camera. You can move “Active Frame” among the windows. There is one bar under the square to display the default preview order of all cameras. To change the order, you can move active frame to the first small window and press numeric keys to input camera index, then move to the second window and do the same operation. If you press 0, then the corresponding window will display “x” without an image.
- **Save setup:** Press “Confirm” button to save preview properties. Press “Cancel” or [ESC] key to abort.

5.3 Alarm setup

5.3.1 External Alarm Input and Relay Output

External Alarm Input and Relay Output is used to setup every external alarm input and output parameters in “Alarms” menu. (Fig.5.11)

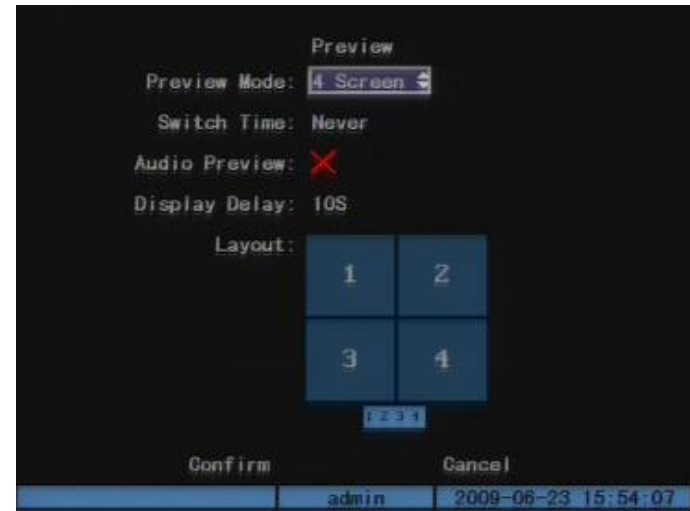

Fig.5.10

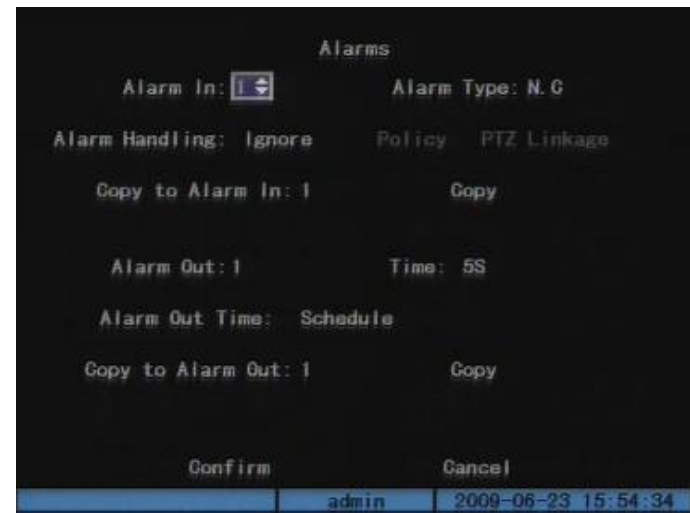

Fig.5.11

External alarm input setup:

Select one alarm input from 1,2,3,4, and then choose an alarm type from “Normal Open” and “Normal Close” according to the sensor type. External alarm input setup includes alarm in handling and alarm in schedule. Alarm in handling includes record camera, PTZ linkage, trigger alarm out, etc.

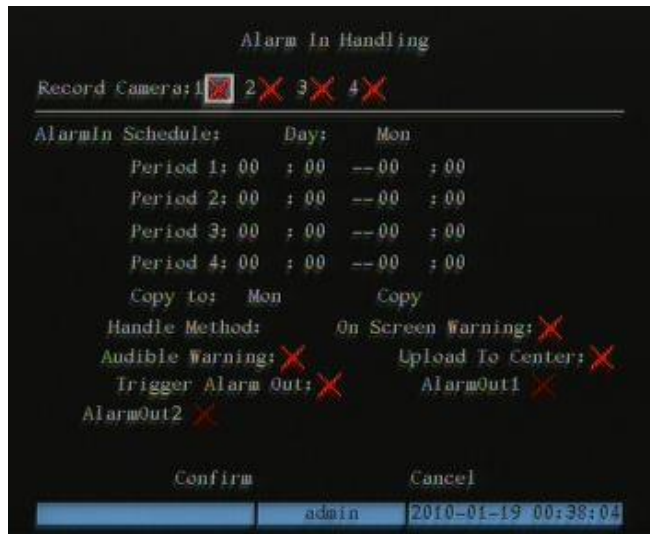

Fig.5.12

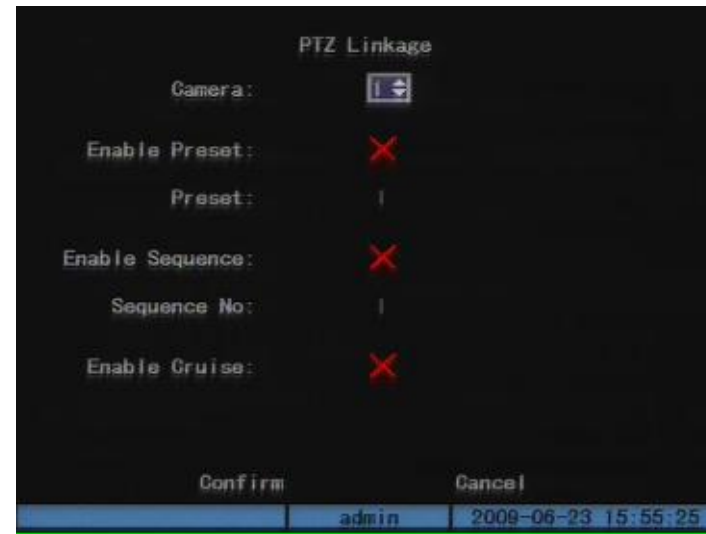

Fig.5.13

You can select channels to record for each alarm input. ("✓" means enable.) Only the selected camera can record, link with PTZ and warn on screen after alarm in.

The linkage order is Alarm in → Trigger camera → Recording, please refer to section 5.4.

PTZ linkage order is Alarm in → Trigger camera → PTZ, PTZ linkage can be setup in "Alarms" and "PTZ Linkage" interfaces. (Fig 5.13) Please make sure the camera has already linked with alarm in; and preset points, sequences, cruises have been set. The maximum number of preset points is 128, sequence is 16 and cruise is 1.

Note: One alarm in can trigger different channels' preset point, sequence and cruise, but can only use one of them.

The order of warning on screen is Alarm in → Trigger camera → Warn on screen. This can be setup by select "On Screen Warning" in "Alarm In Handling" menu. If more than one alarm in or linked with more than one camera, the display images will switch every 10 seconds until the alarm stopping.

In “Handle Method”, you can also setup “Audible warning”, “Upload to Center” and “Trigger Alarm Out”.

The alarm in schedule is in “Alarm In Handling” menu.

Note: The schedule is settled by day, you can copy this to the other days.

The alarm in parameters can be copied to other alarm in channels in “Alarms” menu.

Alarm relay output setup:

In “Alarms” menu you can set output delay time. The options are: 5 Seconds, 10 Seconds, 30 Seconds, 1 Minute, 2 Minutes, 5 Minutes, 10 Minutes and Manual Stop. If you select “Manual” option, the alarm output will not stop until you press “Stop AlmOut” button in “Utilities”. So the actual alarm output time is made up of alarm input time and this delay time.

You can set the alarm output schedule by entering “Schedule” menu from “Alarms” interface. (Fig.5.14)



Fig.5.14

5.3.2 Motion Detection Alarm

Motion Detection Alarm setup includes motion detection area, schedule and policy. In “Image Setup” menu, you need to set detection sensitivity before the other parameters. There are 7 options, from 0 (the lowest) to 5(the highest) and “Off”.

Motion area setup:

Move active frame to “Area” button on the right of sensitivity list box and enter into “Motion Area Setup” interface. The whole screen is divided into 22*18 panes(NTSC:22*15). There is one yellow panel on the upper left side. Firstly, move the yellow pane to your hope position and press[EDIT]key, the yellow pane will be turned into red, then you can use[▼]to expand downward,[▲]to shrink upward,[▶]to expand rightward,[◀]to shrink leftward. After you make sure the red mask area, press[EDIT]key to save the motion area. Press[ESC]key to cancel the motion area.



Fig.5.15 Motion Detection Area Setup

You can use [PTZ] key to set the whole screen as motion area, and multi motion areas can be defined. Press [A]key to clear all motion areas. The minimum area is one panel. After you setup the areas, press [ENTER] key to return “Image Setup” menu.

The keys used to setup motion areas are following:

- Move yellow pane to any position:[▲],[▼],[◀],[▶];
- Yellow pane and red pane switch key:[EDIT];
- Yellow pane and black pane switch key:[EDIT];
- Left shrink red pane:[◀];
- Right enlarge red pane:[▶];
- Down enlarge red pane:[▼];
- Up shrink red pane:[▲];
- Set whole screen as motion area:[PTZ];
- Clear all motion areas:[A];
- Save and return “Image Setup” menu:[ENTER];
- Cancel setup and return “Image Setup” menu:[ESC]

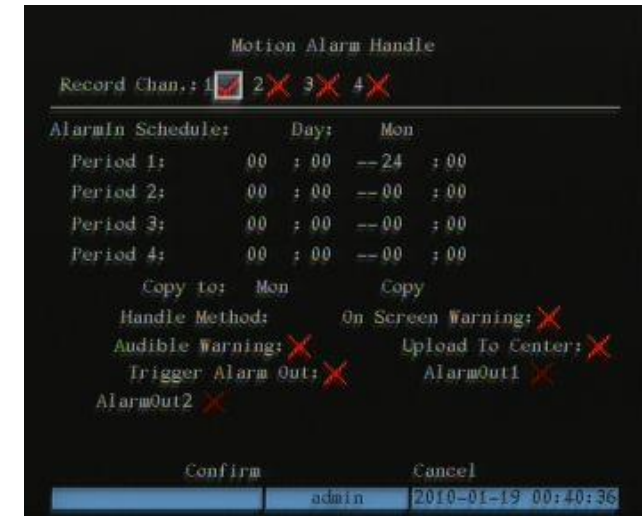

Fig.5.16 Motion Alarm Handle

Motion alarm policy (Fig.5.16):

1. Motion alarm schedule:

You can setup it in “Motion Det.”—>“Policy” menu. The setup steps are the same as external alarm in schedule, please refer to section 5.3.1.

2. Alarm linkage setup:

The alarm linkage setup includes recording, handle method, etc. All the linkages can be set in “Policy” menu. (Fig.5.16) The linkage order of motion detection is Alarm in → Trigger camera → Recording. (Record setup please refer to section 5.4)The alarm handle method includes on screen warning, audible warning, upload to center, trigger alarm out.

Note: If you want to disable motion alarm area and motion alarm policy, you just need to select the motion alarm sensitivity as “Off”.

5.3.3 Video Loss Alarm

When the video cable or camera has something wrong, the video image is lost. If you enable video loss alarm, in such case, DVR will make alarm.

In "Image Setup" menu, select "Handle" in "Signal Loss" list. Enter "Policy" menu to setup alarm schedule and handle methods. The steps please refer to section 5.3.1.

5.3.4 View Tampering Alarm

If you enable this function, when someone blocks the camera spitefully, DVR will make warning alarm. Tampering alarm includes area setup, alarm schedule and handle methods. The setup can be done in "Image Setup"->"View Tampering"->"Area" and "Policy". The default is "Off", there are 3 options: low, Normal and High. Select one of them will active "Area" and "Policy".

Enter into area setup interface; the setup methods are same as that of mask area setup. Only one view tampering area can be setup.(Please refer to section 5.2.5)

Enter into policy setup interface to setup alarm schedule and handle method. The steps please refer to section 5.3.1.

Select "Off" option for "View Tampering", you can disable the view tampering function.

5.4 Recording Setup

In the "Recording channel Configuration" menu, you can setup record image parameters, schedule, pre-record, and post-record.



Fig.5.17



Fig.5.18

Before the recording parameters you need to decide whether “Overwrite” or “Stop Recording” when SD is full. If you select “Overwrite”, when SD in DVR are full, DVR will overwrite the earliest recorded files and continue recording. If you select “Stop recording”, when SD is full, DVR will handle it as “SD Full” exception, please refer to chapter 5.17 for exception menu.

5.4.1 Recording parameters description

- **Stream Type:** There are two options, one is “Audio & Video” stream and other is “Video” stream only. If you want to record video and audio, please select “Audio&Video” option, otherwise you can select “Video” option to record only video.
- **Resolution:** The higher resolution is, the clearer the image is. The resolution options from low to high are: QCIF, CIF, 2CIF, DCIF, 4CIF.
- **Bit Rate Type:** There are two options: “Variable” and “Fixed” .The main features of “Variable” bit rate is it can maintain the image quality under the max bit rate. In this case, DVR can save SD usage and network bandwidth. If you select fixed bit rate, DVR will use the fixed bit rate to compress image.
- **Max Bit Rate:** The max bit rate selection has relations with resolution. If you select high resolution, you must select high bit rate. For CIF resolution, the typical max bit rate is 384K-768Kbps.It is better to select the proper max bit rate based on the camera, background and image quality requirement.
- **Image Quality:** If you select variable bit rate type, you can define image quality. There are 6 options: Highest, Higher, High, Average, Low and Lowest. High image quality needs high bit rate size.
- **Frame Rate:** Frame per second. For low frame rate, you can select low bit rate size.

5.4.2 Pre-Record Time and Post-Record Time

Pre-Record Time: When you enable motion detection recording or external alarm recording, you can define prerecord time. MaxPreRecord is to save all data in Pre Record buffer. The Pre-Record time is related with bit rate. The lower bit rate, the longer Pre-Record time is. The actual time maybe have deviation.

Post Record Time: This is the DVR continue recording time, when external alarm or motion alarm is stopped. The time can be setup according to the requirement.

5.4.3 Record Schedule Setup

In recording menu, enable record function (“✓“flag), press “Schedule” button to enter into recording schedule menu (Fig.5.19)

- **Day:** The recording is settled by day. If everyday has the same schedule, you can copy one day schedule to the other days.

- **All Day, Rec. Type:** If you need to record 24 hours, you can enable “All Day” option and select a record type.
- **Period:** If you do not need record all day or you need to record different types in different period, there are 4 time periods for one day, and each time period can select start time, stop time and different record type.
- **Copy to, Copy:** The setup schedule can be copied to other days.

Note:

1. If record type is “Motion Detect”, you must setup “Motion Detection” in order to trigger motion recording.(Refer to section 5.3.2)
2. If record type is “Alarm”, you must setup “Alarms” in order to trigger alarm recording.(Refer to section 5.13)
3. The time period is among 00:00-24:00.

5.5 Network Parameters

If you want use network to access DVR, you must setup network parameters.

Note: If any network parameter is modified, you must save and reboot DVR to make it into effective.

The parameters can be setup in “Network” menu. (Fig.5.20)

- ***NIC type:** Default is “10M/100M Auto”, the order options are: 10M Half-Dup, 10M Full-Dup, 100M Half-Dup and 100M Full-Dup.
- ***IP:** This IP address must not be conflict with other IP. If there is DHCP server in network, you can set IP as “0.0.0.0”, save and reboot DVR. In reboot process, DVR will search the DHCP server and get one dynamic IP address. If DVR uses PPPoE function, also DVR can dialup into internet and this item will display the dynamic internet IP address.
- ***Port:** Network access port number, must be from 2000 to 65535, the default port is 8000.
- *** Mask:** This is sub net mask.

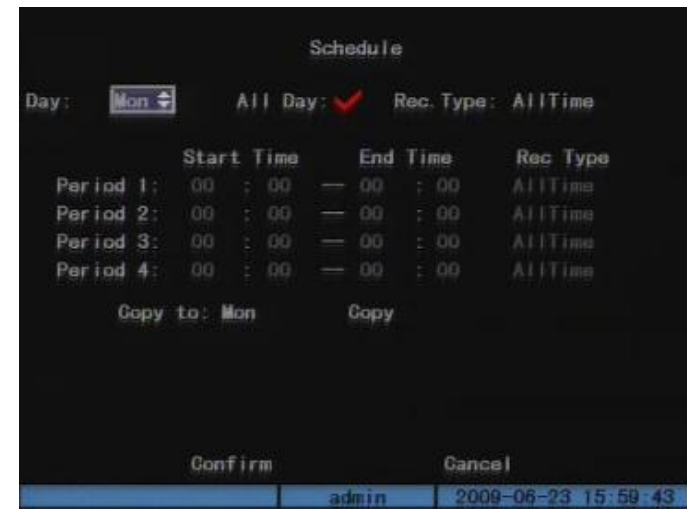

Fig.5.19

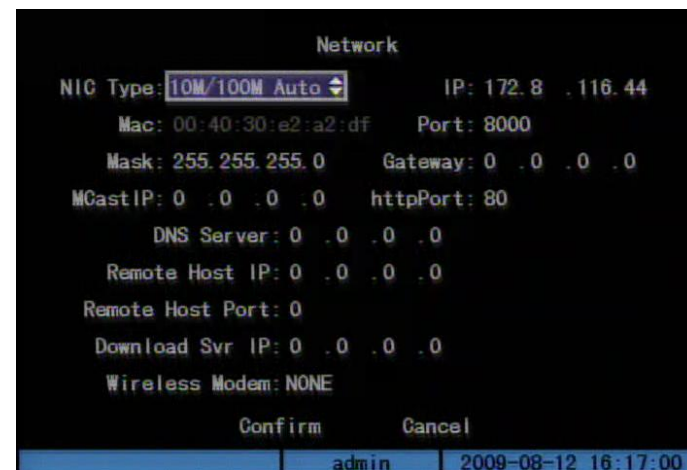

Fig.5.20

- **Gateway:** when the mobile DVR connects to server through a wireless router or communicates in different network segments, you need to setup the gateway IP.
- **Multicast IP:** it is one D-class IP address, among 224.0.0.0 to 239.255.255.255. We suggest using 239.252.0.0 to 239.255.255.255. If you do not use multicast function, you do not need to set.
- **Http Port:** the port is for IE browser. The default value is 80. It can be modified.
- **DNS Server:** reserved
- **Remote Host IP and Port:** If you set this IP and Port, when there is an alarm or an exception happened, DVR will send information to that host IP. (This is reserved.)
- **Download Server IP:** when you use wifi or other network to upload recording files, you need to set the download server IP.
- **Wireless Modem:** It includes: None, CDMA, EVDO, WCDMA, the default option is None. When user use internal wireless module or connect the external module with USB to login the remote server, it is necessary to setup the modem according to the wireless module.

Note: 1. The items with "*" means LAN configurations. If you want to communicate in different network segments, you need to set gateway.

2. The bandwidth of every channel please refers to the Max bit rate setup of section 5.4.1.

5.6 PTZ

In "PTZ" menu, you can setup the PTZ parameters and G-mouse mode. (Fig.5.21)

PTZ parameters include RS-485 parameters, protocol, PTZ address, preset point, sequence and cruise.

G-mouse mode only has one parameter: bit rate.

Firstly, you need to select one camera; the other parameters are as following:

RS-485 parameters: Including baud rate, data bit, stop bit, parity flow control, etc. These parameters must be the same as those of PTZ Protocol.

- **PTZ parameters:** The PTZ protocol of DVR includes Hikvision, Pelco-p, Pelco-D, SAE/YAAN, Samsung, Howell, Panasonic, Philips, etc. The PTZ address in this interface should match the dialed address on PTZ.
- **Preset setup:** Preset is using one number to represent camera's position, zoom, focus and iris. One device has 128 preset points. You can press "Setup" button on the right side of "Preset" item to enter "Set Preset" interface. (Fig.5.22) In this menu you can add, adjust and delete preset points.

Note: PTZ control and external alarm in can call the preset points. Please refer to section 4.4 and section 5.3.1.

- **Sequence setup:** Press "Setup" button on the right side of "Sequence No" item to add cruise point and delete cruise point.



Fig.5.21



Fig.5.22

The parameters of adding cruise point are:

- **Cruise No:** 1 to 16;
- **Preset:** 1 to 128, please ensure the preset point has already been defined.
- **Dwell Time:** the dwell time on the preset point;
- **Dwell Speed:** the speed from one preset point to another point.

Note: PTZ control and external alarm in can call the sequence. Please refer to section 5.3.1.

- **Cruise setup:** Cruise is remembering the track of PTZ movement. This movement is manual controlled. In "PTZ" menu, press "Setup" button on the right side of "Cruise" item, you can enter into "Cruise" setup menu to setup cruise and run the defined cruises. Press "PecCru" button, you will enter into "PTZ control" interface. You can start controlling PTZ with direction keys, press [ENTER] to save the operation track and return "Cruise" setup menu. Press "StartCru" button to repeat the PTZ track until you press "Stop" button.

Note: Please make sure the PTZ you are using can support preset point, sequence and cruise.

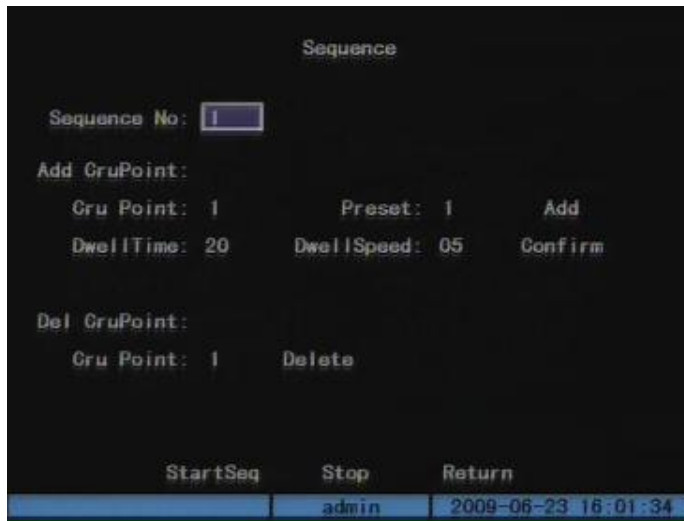

Fig.5.23



Fig.5.24

5.7 Exceptions

The exceptions can be handled include: SD card full, SD card error, illegal access, IP address conflict, network failure, NTSC/PAL differ and speed limit, etc. The parameters can be set in "Exceptions" menu. (Fig.5.25)

You can choose an exception type, then select the handle methods as following:

- **Audible Warning:** DVR beep warning;
- **Upload to Center:** Send exception information to center host PC;
- **Trigger Alarm Output:** Trigger local relay output.



Fig.5.25

You can select more than one handle methods. For example, if you choose exception type as “SD card Error”, you can select “Audible Warning” and “Upload to Center”. When the SD card has an error, the DVR will warning and the center host PC will receive a warning message.

Note: Speed limit function need GPS, user can set that in “Mobile”->“GPS”.

5.8 Mobile Setup

Mobile setup is a special menu for mobile DVR (Fig.5.25), including:

- **Boot & Halt:** control the power on/ off time of mobile DVR.
- **GPS:** GPS functions and parameters.
- **PPP:** Set wireless modem type and parameters.
- **WVS:** the parameters for login the wireless remote monitoring server.
- **iVMS:** the parameters for login the iVMS7000 platform.

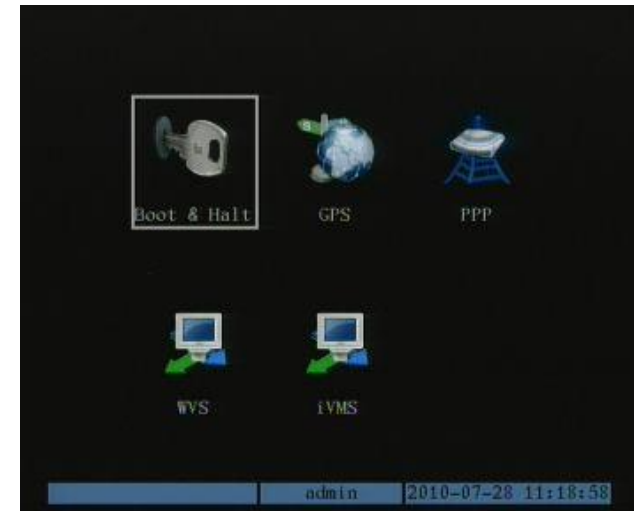

Fig.5.26 Mobile Setup

5.8.1 Boot & Halt Setup

In the boot & halt menu (Fig.5.27), you can setup the shutdown mode and time. There are two normal modes:

1. Halt Delay

When the KEY interface of the device link with the vehicle’s ignition switch, you can delay halt by setup the parameters. (The connection method please refer to section 2.3.3)

As in Fig.5.27, user can set a halt delay time which means the DVR will continuously working after the vehicle power off until exceeding the halt delay time. The minimum delay time is 0 min, the maximum delay time is 6 hours. The recommended period is between 30 min to 2 hours.

2. Auto Work

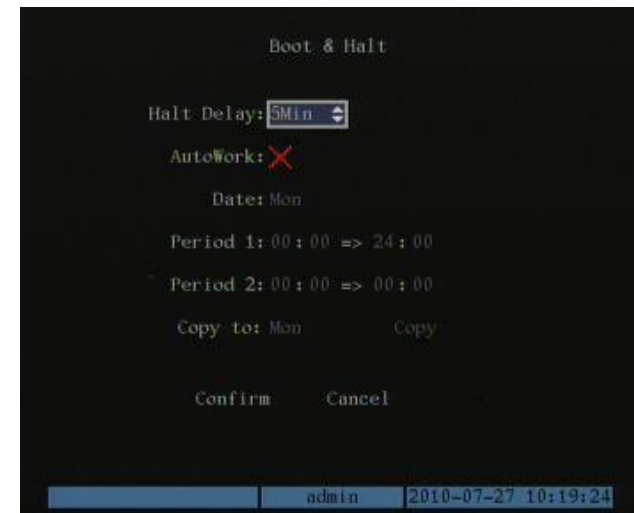

Fig.5.27 Boot&Halt

If you have directly connected the positive pole of DVR KEY to vehicle battery (Please refer to section 2.3.3), you can also select auto work function. The auto work time can be set in "Boot & Halt" menu. The device will auto power on/off according to the setup time.

- **Auto Work:** "✓" means start the auto work function. Press [EDIT] to switch.
- **Date:** the auto work setup is set by day; you can copy the schedule to the other days.
- **Period 1, Period 2:** you can set two auto work periods for one day. The periods cannot overlap.
- **Copy to, Copy:** the settled time can be copied to other days.

Note:

1. After auto halt of device, if user need to boot it again, please disconnect "KEY" and reconnect it before booting the device.
2. When booting the DVR beyond the auto on/off time, if there is no operation or user login in 5 min, the device will auto halt:

5.8.2 GPS Setup

DS-8104HMI-M supports build-in GPS module. When using the DVR with GPS module, please connect antenna correctly (details please refer to section 2.3). When receiving GPS signal, it starts positioning function.

Note: To ensure the GPS module works effectively, please put the antenna on car roof or under windshield glass and make sure it is not be shielded.

- **Time correct:** "✓" means the GPS time correction is enable. You can choose the corresponding time zone. (The default time zone is GMT+08:00, Range: GMT+12:00 to GMT-12:00) When the GPS signals are received, the system will correct time every 5 mins.
- **Speed Unit, Max Speed:** "Speed Unit" and "Max Speed" is used to control the vehicle's speed by GPS information. You can set a maximum speed and setup warning handle method in "Exceptions" menu. When the vehicle is overspeed, the DVR will trigger the alarm. (Please refer to section 5.7) The speed unit has two options: KPH/MPH. The default max speed is 100KPH and 62MPH, this can be modified.
- **Display Channel:** You can set whether the GPS information display on each channel. "✓" means the selected channel will display the GPS information including the latitude, longitude, speed of the vehicle.(Please refer to section 4.2)

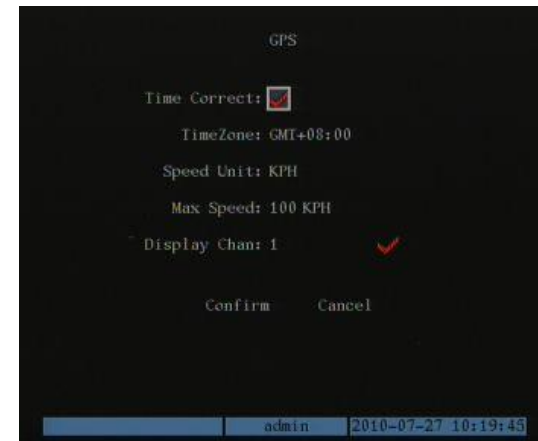

Fig.5.28

5.8.3 PPP settings

For DS-8104HMI-M, there are 3 options of wireless modem, including WCDMA, EVDO(cdma2000), TS-SCDMA. In this menu, user can set the parameters of the build-in module for the wireless network transmission. The menu is shown in Fig 5.29:

The default option is None, the module type can be distinguished by the device name:

Device Name	Module Type
DS-8104 HM-M	None
DS-8104 HM-M/GS	TD-SCDMA
DS-8104 HM-M/GW	WCDMA
DS-8104 HM-M/GE	EVDO

Before enable wireless module, please get the information of the network (including APN, number, username and password) from ISP.

Before parameters setup, please connect antenna and keep it vertical. Select the correct module type and input corresponding parameters in “PPP” menu. After rebooting, the device will dial-up automatically and get the WAN IP.

Note:

When setting dial-up parameters, user needs to input numbers, letters and symbols. The input details please refer to section 3.3.

5.8.4 Server Login Setup

DS-8104HMI-M(/XX) series mobile DVR can support WVS platform and iVMS platform, the corresponding login parameters have to be set before the device login the wireless network server in “WVS” menu and “iVMS” menu.

1. WVS login settings

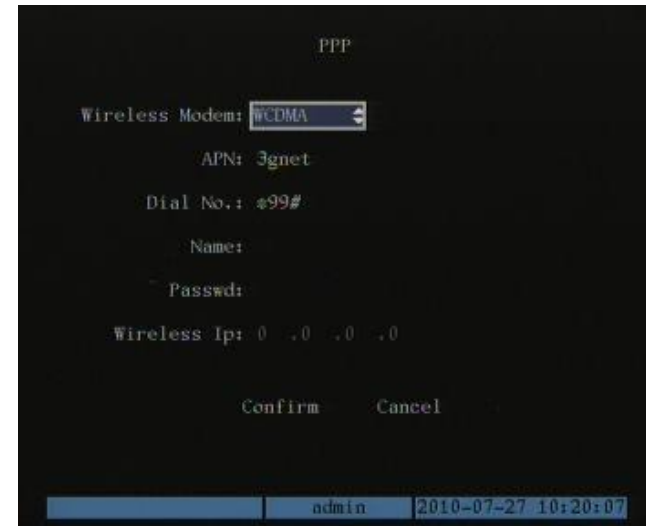

Fig.5.29

The WVS login interface is shown in Fig.5.30:

Used For: there are 4 options for the network environments: CDMA/EDGE/GPRS, 3G, WLAN, LAN.

Server IP: input the WVS server static WAN IP.

Port: should be as same as the client port of server, the default is 5660.

Login id and Login Psw: the id and password assigned by the manage system; you can get these from the manage system. The ID is beginning with "1", and has 9 numbers.

2. iVMS login settings

The iVMS 7000 series platform login interface is shown in Fig.5.31:

Server IP: input the iVMS 7000 center server static WAN IP.

Port: connect port between DVR and center server, the default is 7660.

Login id: the ID assigned by the server; you can get these from the iVMS7000 server. Please add the ID in iVMS7000 management center before using.

The setup of the server login parameters will become effective after reboot. When the device connects to wireless network successfully, it will login the central manage center automatically and show online status. Then user can preview the video via client server.

Note:

1. WVS platform is priority. If you want to login iVMS platform, please set WVS platform IP address as 0.
2. Considering the network bandwidth will affect the video transmission, when preview with sub stream at client, 3 channels are maximum. This is valid for both iVMS platform and other client software.

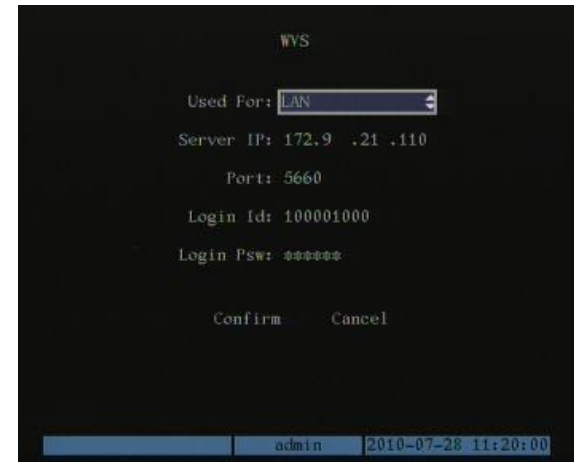

Fig 5.30

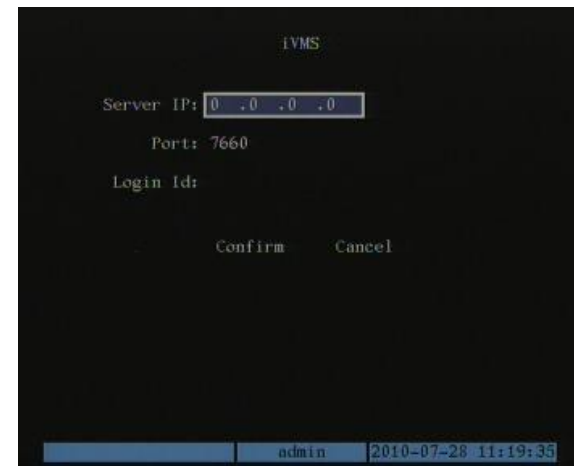

Fig 5.31

6 Utilities

The “Utilities” menu is used for day-to-day management and maintenance of DVR. Including “SavePara”, “RestorePara”, “Upgrade”, “SD Card”, “Stop Alarm Out”, “Reboot”, “Power Off”, “View Log” and “System Info”. The “Utilities” menu is shown in Fig.6.1.

6.1 Save Parameters

Save current parameters to device FLASH, this change will take effective after reboot. (Fig.6.1, Fig.6.2)

6.2 Restore Parameters

Restore factory parameters for DVR. The IP address, gateway, port number and mask will not be restored. (Fig.6.1, Fig.6.3)



Fig.6.1

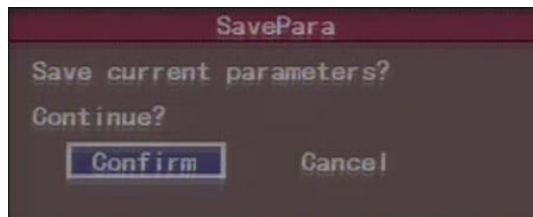

Fig.6.2

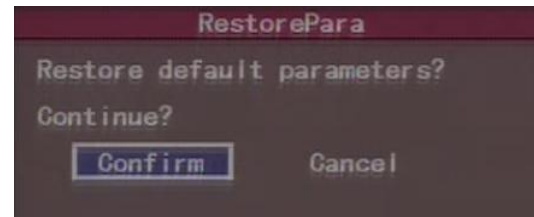

Fig.6.3

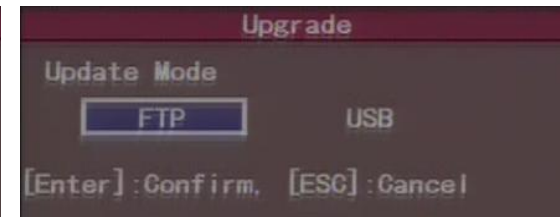

Fig.6.4

6.3 Upgrade

You can use this function to upgrade the firmware. Please confirm the language is matched. Press “Upgrade” icon, in the pop-up dialog, you can select either “FTP” or “USB” upgrade mode. (Fig.6.4)

If you select “FTP” mode, you will enter into “FTP Upgrade” menu (Fig6.5):

In this method, you need a host PC that is in the same LAN as DVR, and the host PC starts FTP service. Copy the upgrade firmware to the ftp server. Input the ftp server IP and press [Enter]. DVR will connect with FTP server through network and download the upgrade firmware file.

If you select “USB” mode, please make sure you connect one USB flash memory with DVR and the firmware file is in its root directory.

Reboot after successfully upgrading, the system will use the new firmware.

Note: Upgrade failure will give rise to exception after rebooting, please contact the supplier to repair.

6.4 SD Card

Check SD work status:

Capacity, Free space, Stand by or not, Normal status or not.

Format SD:

Before formatting stop all recording. After formatting, you must reboot DVR, otherwise DVR will not work normally.

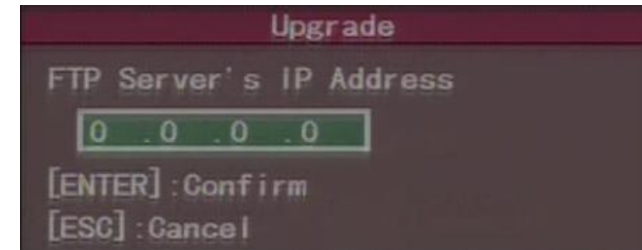

Fig.6.5

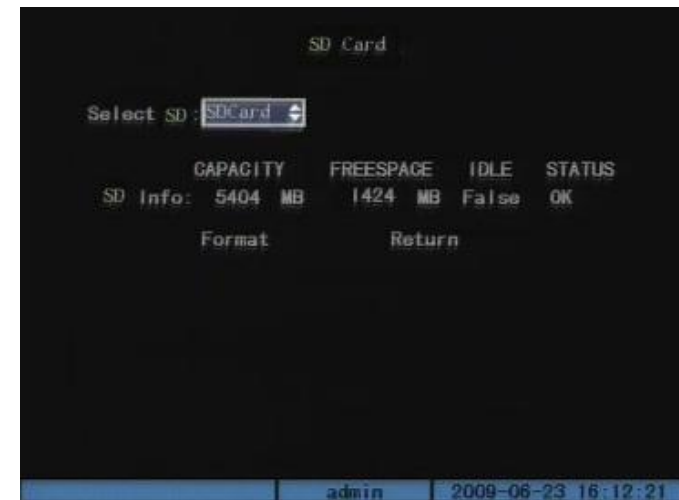

Fig.6.6

6.5 Clear Alarm Out

Clear the alarm output manually.

6.6 Reboot

Reboot DVR

6.7 Power Off

Not available for mobile DVR.

6.8 View Log

After enter into the “LOG” menu, you can check the log(Fig.6.7)

Press[↔]key on the front panel to view all the log, this will list the earliest 2000 record log. (8 items per page, 250 pages)Also you can select options to search.

Search by type

Type is divided into “Major type” and “Minor type”. Major type includes operation, alarm, exception and all.

The operation major type include Power On, Shut Down, Abnormal Shut, Panel Login, Panel Logout, Panel Config, Panel File Play, Panel Time Play, Local Start Record, Local Stop Record, Panel PTZ, Panel Preview, Panel Set Time, Local Upgrade, Net Login, Net Logout, Net start Record, Net Stop Record, Net Start Transparent Channel, Net Stop Transparent Channel, Net Get Parameter, Net Config, Net

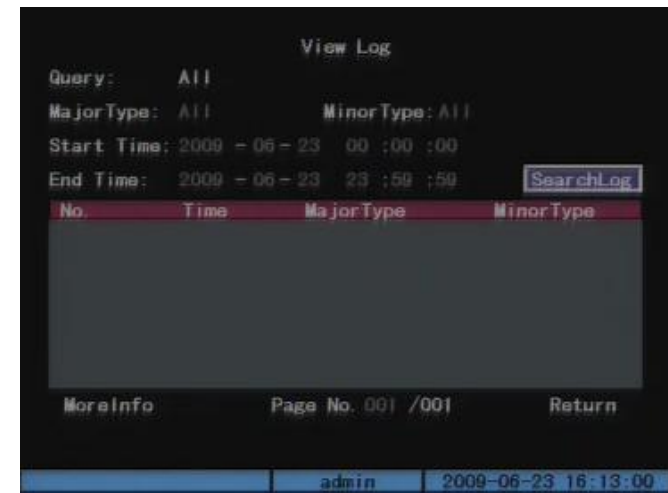

Fig.6.7

get Status, Net Alert On, Net Alert Off, Net Reboot, BiComStart(Start Voice Talk), BiCom Stop(Stop Voice Talk), Net Upgrade, Net File Play, Net Time Play, Net PTZ and so on.

For alarm major type, the minor type includes: External Alarm In, External Alarm Out, Motion Detect Start, Motion Detect Stop, View Tamper Start, View Tamper Stop and so on.

For exception minor type, the minor type includes: Video Signal Loss, Illegal Access, SD Card Error, SD Card Full, IP Conflict, DCD Lost and so on.

Search by time

Select "By Time", input start time and stop time. After finish searching, DVR will list the matched log information. (2000 items maximum)

Search by type & time

Select "By Type & Time", input major type, minor type, start time and stop time. DVR will list the matched log information.

Note: After the DVR listing the matched log information, you can check more items by pressing "MoreInfo", including panel user, net user, host address, parameter type, channel No., SD No., alarm in, and alarm out. You can use "Page No." to change page.

6.9 System Information

Press "System Info" icon , you can get DVR system information includes Unit Name, Device Model, Serial Number, Firmware Version and Encode Version. Please provide accurate and total system information, when consult with supplier.

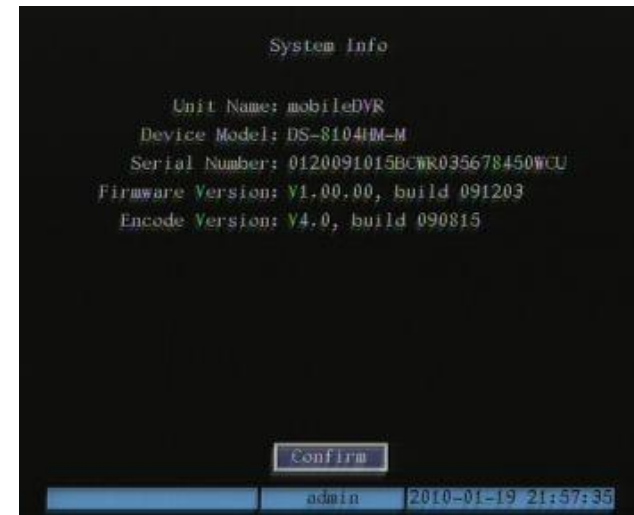

Fig.6.8

Appendix A SD Capacity Calculation

Calculate total capacity needed by each DVR according to video recording (video recording type and video file storage time).

Step 1: According to Formula (1) to calculate storage capacity that is the capacity q_i of each channel needed for every hour, unit Mbyte.

$$q_i = d_i \div 8 \times 3600 \div 1024 \quad (1)$$

In the formula: d_i -- the bit rate, unit Kbit/s

Step 2: After video time requirement is confirmed, according to Formula (2) to calculate the storage capacity m_i , which is storage of each channel needed unit Mbyte.

$$m_i = q_i \times h_i \times D_i \quad (2)$$

In the formula: h_i -- The recording time for each day (hour)

D_i -- Number of days for which the video shall be kept

Step 3: According to Formula (3) to calculate total capacity (accumulation) q_T that is needed for all channels in the DVR during **scheduled video recording**.

$$q_T = \sum_{i=1}^c m_i \quad (3)$$

In the formula: c -- Total number of channels in one DVR

Step 4: According to Formula (4) to calculate total capacity (accumulation) q_T that is needed for all channels in DVR during **alarm video recording (including motion detection)**.

$$q_T = \sum_{i=1}^c m_i \times a\% \tag{4}$$

In the formula: $a\%$ — Alarm occurrence rate

For example: According to the above formula, if the bit rate type is FIXED, for different bit rate, the file size of ONE channel in ONE hour is:

Bit Rate(Max Bit Rate)	File Size	Bit Rate(Max Bit Rate)	File Size	Bit Rate(Max Bit Rate)	File Size
96k	42M	320k	140M	896k	393M
128k	56M	384k	168M	1.00M	450M
160k	70M	448k	196M	1.25M	562M
192k	84M	512k	225M	1.50M	675M
224k	98M	640k	281M	1.75M	787M
256k	112M	768k	337M	2.00M	900M

Appendix B ETHERNET Connect Cable Made Method

Material and tool:

One twist cable (8 pin, the length can be defined as to the actual demand, but must be within 100m), 2 standard RJ45 head, one tool for RJ45.
Suggestion: have a network cable test tool to test each cable made.

Pin definition:

To make the network cable according to the actual situation, there are two options:

- (1) Use the following left side method to make the network cable when DVR is connected with network hub or switch.
- (2) Use the following right side method to make the cross network cable when DVR is directly connected with client-end PC.

1 (white-orange)-----1 (white-orange)
2 (Orange) -----2 (Orange)
3 (white-green) ----- 3 (white-green)
4(blue) -----4(blue)
5(white-blue) ----- 5(white-blue)
6(green) -----6(green)
7(white-brown) ----- 7(white-brown)
8(brown) ----- 8(brown)

Straight-line connection

1 (white-orange)----- 1 (white-green)
2 (Orange) ----- 2 (green)
3(white-green) ----- 3 (white-orange)
4(blue) ----- 4 (blue)
5 (white-blue) ----- 5 (white-blue)
6 (green) ----- 6 (Orange)
7 (white-brown) ----- 7 (white-brown)
8 (brown) ----- 8 (brown)

Cross-line connection

Appendix C Specifications

Model	DS-8104HMI-M(/XX)
Operating System	Embedded RTOS
Video Compression Standard	H.264
Preview Resolution	PAL:704×576(4CIF);NTSC:704×480(4CIF)
Playback Resolution	4CIF(6fps)/DCIF(12fps)/2CIF(15fps)/CIF(fps)/QCIF(fps)
Video Input	1/4-ch (1.0Vp-p,75Ω),PAL/NTSC adaptive
Video Output	1-ch (1.0Vp-p,75Ω),PAL/NTSC optional
Frame Rate	PAL:1/16—25fps;NTSC:1/16—30fps
Bit Rate	32Kbps~2Mbps(Self definition)8Mbps MAX
Audio Compression Standard	OggVorbis
Audio Input	1/2-ch (2.0~2.4Vp-p,1000Ω)
Audio Output	1-ch (2.0~2.4Vp-p,600Ω)
Stream Type	Video stream or Video & Audio stream
Alarm Input	7-ch level input, 1-ch impulse input
Alarm Output	2-ch alarm output
Wireless Network	Optional internal module, SMA antenna interface
GPS	Internal high sensitivity GPS module, SMA antenna interface
SD Interface	SD can max support 32GB
Data Backup	SD card backup, USB Backup
Communication Interface	1 LAN; 1 RS485; 1 USB
Delay Shutdown	5min to 6h delay after vehicle power off
Auto on/off	24h auto on/off
Power Supply	Wide-board power supply, 6VDC~36VDC
Power Output	12VDC/2A, 5VDC/2A
Power Consumption	5W

Operating Temperature	-10°C ~ +55°C
Humidity	10% ~ 95%
Dimensions	155mm×45mm×105mm
Weight	About 1Kg
Device Control	Special wire control for mobile DVR

Appendix D FAQ

Q: why a new machine has “di-di-di-di” voice warning after boot?

A: Reason1: there is no SD in DVR

Reason2: the SD is not initialized

Reason3: SD is broken

If do not need the SD, please go to the exception settings menu, disable the voice warning of “SD error” as “x”. If it has SD, please go to SD management menu and initialize the SD. If the SD is broken, please change a new one.

Q: why the monitor has no response when operating the remote controller?

A: The correct way of using the remote controller is: make sure the battery has been installed correctly before use the remote controller. After the device power on ready, press [Device] button input →device code→ press [ENTER]. Then you can control the device by pressing [MENU]. (If the device code is 255, you can directly control the device with this remote controller by pressing [MENU] button. The default device code is 255.) If it still does not work after repeating many times.

Please check the reasons:

1. Check the battery’s positive and negative polarity
2. Check the battery’s power
3. Check the connected wire is in good condition

After exclude all of above reasons, please change a new remote controller; if it still does not work, please contact the supplier.

Q: why DVR cannot display GPS information after antenna connecting?

A: Please check the following conditions:

1. The GPS antenna is outdoor or out of car;
2. The GPS antenna is not covered or blocked by other objects;
3. When using for the first time, please choose an open space;

4. The GPS information display channel is set in “GPS” menu. press [Device] button input →device code→ press [ENTER]. Then you can control the device by pressing [MENU]. (If the device code is 255, you can directly control the device with this remote controller by pressing [MENU] button. The default device code is

255.) If it still does not work after repeating many times. Please check the reasons:

1. Check the battery's positive and negative polarity
2. Check the battery's power
3. Make sure the remote controller is not tampered.
4. Check around and make sure there is no fluorescent lamp used.

After exclude all of above reasons, please change a new remote controller; if it still does not work, please contact the supplier.

After exclude all of above reasons, please change a new GPS module; if it still does not work, please contact the supplier.

Note: In caves, tunnels and some other environments, there is no GPS signal.

Q: why dial-up is failed?

- A:
1. Please make sure the device have wireless module inside.
 2. Please check the antenna is connected correctly and vertical.
 3. Please check the status of SIM card, make sure it can work for dial-up.
 4. Please check the module selection and corresponding parameters in "Mobile setup"->"Dial up setup".
 5. The weak 3G signal may also cause dial-up failure, please make sure the parameters are correct, reboot the DVR and try again.