

100%-0%
Dimming Knob

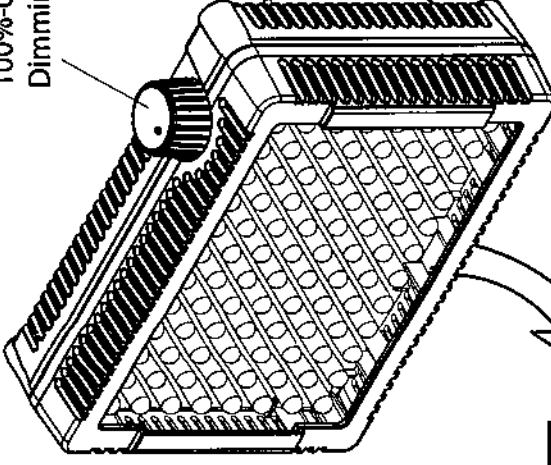

Three Gel Filters

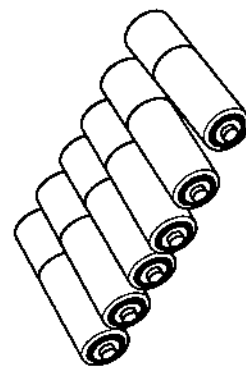
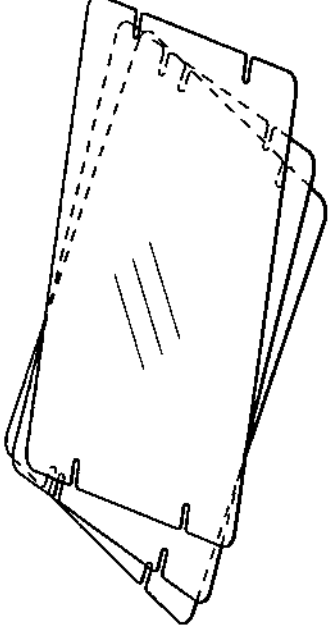

Six AA Batteries (not included)
Use Energizer® e2 LITHIUM
batteries for optimum duration
and highest output.

DV Adapter (Optional)

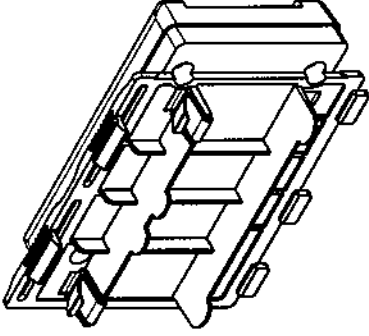

AC Adapter (Optional)

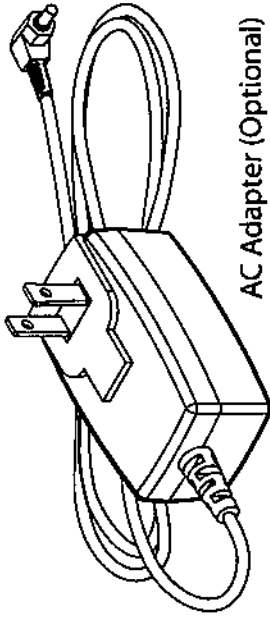

Ball and Socket
Articulating Camera
Shoe (included)

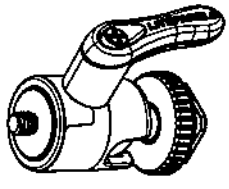

1/4-20 Threaded Hole

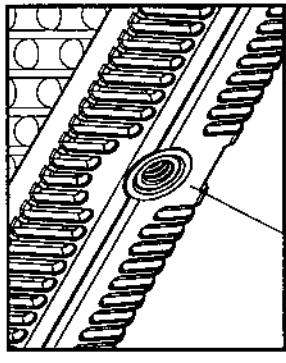

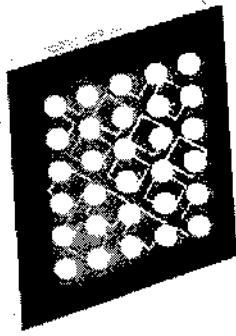

LITE PANELS®

Litepanels® MicroPro Instructions

The MicroPro can be powered from 6 AA batteries or an optional AC Adapter.

To insert the batteries, remove the back panel and place them according to the illustration inside the fixture housing. "Heavy Duty" alkaline cells or better are recommended for maximum duration (1 1/4 - 1 1/2 hours) at highest output. Rechargeable AA and Lithium batteries can be used as well. Lithium batteries will power the MicroPro up to 6 hours.

It is best to remove the batteries when not using the MicroPro for extended periods (3+ days)

The optional AC Adapter plugs into the 5-16VDC input jack at bottom left on the back of the fixture housing. The AC Adapter can be used with, but will not charge, the batteries inside the fixture housing.

To engage and control light output, simply turn the control knob atop the fixture housing clockwise to the desired output level. Reverse this procedure until it "clicks" to fully turn off the MicroPro.

Tighten the lever on the included ball-head adapter, and then screw the 1/4"-20 threaded end firmly into the matching receiver that is on the bottom of the MicroPro housing.

Slide the ball-head onto a camera via the hot-shoe plate adapter and secure it with the wheel nut. The hot-shoe adapter in the bottom of the ball-head has an integrated 1/4"-20 threaded receiver for additional mounting options. Use the lever on the ball-head to control the tilt and pan mechanism.

The laminated filters slide into the two raised ducts that reside to the left and right of the clear faceplate. When they are not being used the filters can be stored on the back of the fixture in similar storage ducts located to each side of the battery door. Filters are provided in 1/4 and full color correction and may be used together.

Warning: Do not expose or immerse the MicroPro to liquids to prevent circuit failure

Litepanels, Inc.
16152 Saticoy Street, Van Nuys, Ca 91406 USA
Tel. +1.818.752.7009 Fax +1.818.752.2437
www.litepanels.com